

# *Grizzly* *Industrial, Inc.*®

## MODEL H5527 18 GAUGE BRAD NAILER OWNER'S MANUAL



COPYRIGHT © JULY, 2003 BY GRIZZLY INDUSTRIAL, INC., REVISED MARCH, 2008 (TS)  
**WARNING: NO PORTION OF THIS MANUAL MAY BE REPRODUCED IN ANY SHAPE  
OR FORM WITHOUT THE WRITTEN APPROVAL OF GRIZZLY INDUSTRIAL, INC.**  
#TR5451 PRINTED IN CHINA

## **WARNING!**

This manual provides critical safety instructions on the proper setup, operation, maintenance and service of this machine/equipment.

Failure to read, understand and follow the instructions given in this manual may result in serious personal injury, including amputation, electrocution or death.

The owner of this machine/equipment is solely responsible for its safe use. This responsibility includes but is not limited to proper installation in a safe environment, personnel training and usage authorization, proper inspection and maintenance, manual availability and comprehension, application of safety devices, blade/cutter integrity, and the usage of personal protective equipment.

The manufacturer will not be held liable for injury or property damage from negligence, improper training, machine modifications or misuse.

## **WARNING!**

Some dust created by power sanding, sawing, grinding, drilling, and other construction activities contains chemicals known to the State of California to cause cancer, birth defects or other reproductive harm. Some examples of these chemicals are:

- Lead from lead-based paints.
- Crystalline silica from bricks, cement and other masonry products.
- Arsenic and chromium from chemically-treated lumber.

Your risk from these exposures varies, depending on how often you do this type of work. To reduce your exposure to these chemicals: Work in a well ventilated area, and work with approved safety equipment, such as those dust masks that are specially designed to filter out microscopic particles.

# SAFETY

## WARNING

### For Your Own Safety Read Instruction Manual Before Operating This Equipment

The purpose of safety symbols is to attract your attention to possible hazardous conditions. This manual uses a series of symbols and signal words which are intended to convey the level of importance of the safety messages. The progression of symbols is described below. Remember that safety messages by themselves do not eliminate danger and are not a substitute for proper accident prevention measures.



Indicates an imminently hazardous situation which, if not avoided, **WILL** result in death or serious injury.



Indicates a potentially hazardous situation which, if not avoided, **COULD** result in death or serious injury.



Indicates a potentially hazardous situation which, if not avoided, **MAY** result in minor or moderate injury. It may also be used to alert against unsafe practices.

**NOTICE**

This symbol is used to alert the user to useful information about proper operation of the equipment.

## WARNING

### Safety Instructions For Pneumatic Tools

1. **KEEP ALL SAFETY DEVICES IN PLACE** and in working order.
2. **REMOVE ADJUSTING KEYS AND WRENCHES.** Form habit of checking to see that keys and adjusting wrenches are removed from tool before operation.
3. **KEEP WORK AREA CLEAN.** Cluttered areas and benches invite accidents.
4. **DO NOT USE IN DANGEROUS ENVIRONMENT.** Do not use pneumatic tools in damp or wet locations, or where any flammable or noxious fumes may exist. Keep work area well lighted.
5. **KEEP CHILDREN AND VISITORS AWAY.** All children and visitors should be kept at a safe distance from work area.
6. **MAKE WORKSHOP CHILD PROOF** by locking your shop and shutting off air valves.
7. **DO NOT FORCE TOOL.** It will do the job better and safer at the rate for which it was designed.
8. **USE THE RIGHT TOOL.** Do not force tool or attachment to do a job for which it was not designed.
9. **DO NOT USE UNDER THE INFLUENCE OF DRUGS OR ALCOHOL.**

# WARNING

## Safety Instructions For Pneumatic Tools

10. **USE PROPER AIR HOSE** for the tool. Make sure your air hose is in good condition and is long enough to reach your work without stretching.
11. **WEAR PROPER APPAREL.** Do not wear loose clothing, gloves, neckties, rings, bracelets, or other jewelry which may get caught in moving parts. Non-slip footwear is recommended. Wear a protective hair covering to contain long hair.
12. **ALWAYS USE SAFETY GLASSES.** Also use a face or dust mask if cutting operation is dusty. Everyday eyeglasses only have impact resistant lenses, they are NOT safety glasses.
13. **WEAR APPROVED HEARING PROTECTION.** Air escaping from pneumatic tools can exceed safe exposure limits and may cause hearing damage with prolonged exposure.
14. **SECURE WORK.** Use clamps or a vise to hold work when practical. It is safer than using your hand and frees both hands to operate tool.
15. **MAINTAIN TOOLS WITH CARE.** Keep tools lubricated and clean for best and safest performance. Follow instructions for lubricating and changing accessories.
16. **REDUCE THE RISK OF UNINTENTIONAL FIRING.** Do not carry tool with hand on trigger and always disconnect from air when not in use.
17. **DISCONNECT TOOLS** before servicing, changing accessories, or moving to another location.
18. **DO NOT OVERREACH.** Keep proper footing/balance at all times.
19. **USE THE RECOMMENDED ACCESSORIES.** Consult owner's manual for recommended accessories. The use of improper accessories may cause risk of injury.
20. **CHECK FOR DAMAGED PARTS BEFORE USING.** Check for binding and alignment of parts, broken parts, part mounting, loose bolts, and any other conditions that may affect machine operation. Repair or replace damaged parts.
21. **NEVER LEAVE UNATTENDED TOOL CONNECTED TO AIR.** Disconnect the air hose and do not leave tool until it is relieved of any built up pressure.
22. **NEVER ALLOW UNTRAINED USERS TO USE THIS TOOL WHILE UNSUPERVISED.**
23. **IF YOU ARE UNSURE OF THE INTENDED OPERATION, STOP USING TOOL.** Seek formal training or research books or magazines that specialize in pneumatic tools.
24. **BE AWARE OF HOSE LOCATION WHEN USING PNEUMATIC TOOLS.** Hoses can easily become a tripping hazard when laid across the floor or spread out in a disorganized fashion.

# WARNING

## Additional Safety Instructions for Nailers/ Staplers

- 1. HAND INJURIES:** Do not place your hands near the nail/staple point of entry. A nail/staple can deflect and tear through the surface of the workpiece, puncturing your hand or fingers.
- 2. COMBUSTIBLE GASES:** Never connect the nailer/stapler to pressurized oxygen or other combustible gases as an air source. Only use filtered, lubricated, and regulated compressed air.
- 3. SAFE HANDLING:** Never point the nailer/stapler at others! Do not keep the trigger pulled when loading fasteners, carrying, or holding tool. Carry the tool only by the handle, never by any other part. Do not carry the tool by the air hose. Disconnect the nailer/stapler from the air hose when going up and down ladders.
- 4. MODIFICATIONS:** DO NOT modify this tool or bypass the safety nose mechanism.
- 5. COMPRESSED AIR RATING:** Do not connect the nailer/stapler to compressed air that exceeds 120 PSI.
- 6. HOSE USAGE:** Make sure your air hose is designed for the tool in use, is in good condition, and is long enough to reach your work without stretching. However, an overly long air hose in the work area may be a tripping hazard.
- 7. OPERATING QUESTIONS:** If you are not sure about the intended operation, stop using the nailer/stapler. Seek formal training.
- 8. CLEANING:** Never use gasoline or other flammable liquids to clean the nailer; vapors in the nailer/stapler will ignite by a spark and cause it to explode.
- 9. MAINTENANCE:** Always disconnect air from the nailer/stapler when servicing or installing nails. During maintenance, a nailer/stapler connected to air may fire accidentally, causing serious personal injury.
- 4. CHECK VALVE:** Do not use a check valve or any other fitting that allows air to remain in the tool after it is disconnected from the air source.



# INTRODUCTION

---

---

## Foreword

---

---

The specifications, details, and photographs in this manual represent the Model H5527 as supplied when the manual was prepared. However, owing to Grizzly's policy of continuous improvement, changes may be made at any time with no obligation on the part of Grizzly.

If you have any comments regarding this manual, please contact us:

Grizzly Industrial, Inc.  
C/O Technical Documentation Manager  
P.O. Box 2069  
Bellingham, WA 98227-2069  
Email: manuals@grizzly.com

Most importantly, we stand behind our tools. If you have any service questions or parts requests, please call or write us at the location listed below.

Grizzly Industrial, Inc.  
1203 Lycoming Mall Circle  
Muncy, PA 17756  
Phone: (570) 546-9663  
Fax: (800) 438-5901  
E-Mail: techsupport@grizzly.com  
Web Site: <http://www.grizzly.com>

## Machine Data

---

---

Nail Gauge..... 18  
Nail Length .....  $\frac{5}{8}$ "-2"  
Magazine Capacity ..... 100 Nails  
Air Inlet .....  $\frac{1}{4}$ " NPT  
Weight ..... 3 $\frac{1}{2}$  lbs.  
Operating Pressure ..... 60-100 PSI

# SETUP

---

---

## Unpacking

---

---

Your new item was carefully packaged for safe shipping. If you discover any damage after you have signed for delivery, *immediately call Customer Service at (570) 546-9663 for advice.*

Save the containers and all packing materials for possible inspection by the carrier or its agent. *Otherwise, filing a freight claim can be difficult.*

When you are completely satisfied with the condition of the shipment, you should inventory the contents.

---

---

## Inventory

---

---

After you open the nailer box, you should find the following.

### Model H5527 Inventory (Figure 1)

- A. Carrying Case..... 1
- B. Brad Nailer..... 1
- C. Hex Wrenches 3mm, 4mm ..... 1 Each
- D. Safety Glasses..... 1



Figure 1. Model H5527 inventory.



# Compressed Air System

The Model H5527 is designed to be operated at 60-100 PSI using clean, dry, regulated, compressed air. **DO NOT exceed the 120 PSI maximum operating pressure for your model.**

Before using your new nailer, regulate the air pressure on your air compressor to the minimum PSI for your model.

An in-line filter/lubricator/regulator unit, depicted in **Figure 2**, can be installed and should be located as close to the nailer as possible.

This filter/lubricator/regulator unit will protect your tool from damaging water build-up, allow you to adjust and maintain constant air pressure to your tool, and save you the inconvenience of having to manually lubricate your tool every time you use it.

## ⚠ WARNING

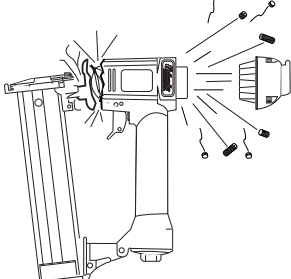

**Exceeding the maximum permissible operating pressure may cause the nailer to explode, blowing metal fragments in all directions. To protect yourself from serious personal injury, DO NOT allow your air compressor to exceed the recommended pressure when connected to this nailer!**

Check the current Grizzly catalog for availability of this unit. If you plan on installing a filter/lubricator/regulator unit in your compressed air system, always follow the connection instructions that come with the unit.

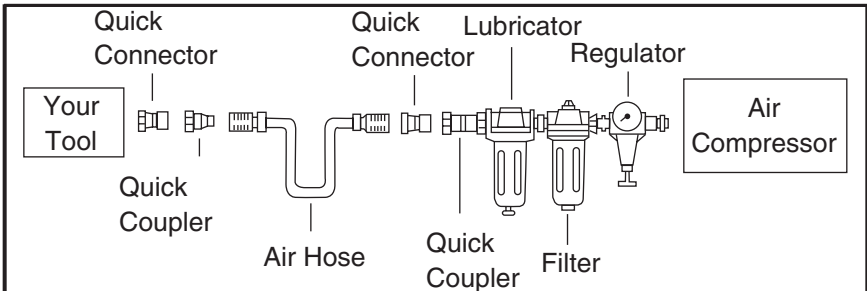

**Figure 2.** Typical filter/lubricator/regulator installation order.

# Safety Nose Mechanism

---

---

A safety mechanism on the nose of the nailer protects against accidental firing. When the trigger is pressed, the nailer will not fire until the safety nose mechanism is depressed.

Before you use your nailer for the first time, check the safety nose mechanism to ensure proper function.

## To check the safety nose mechanism:

1. DISCONNECT NAILER FROM THE AIR SUPPLY!
2. Make sure the magazine is empty and contains no nails.
3. Make sure the trigger and the safety nose mechanism move up and down without sticking.
4. Connect the nailer to the air supply.

## **WARNING**

The safety mechanism is a mechanical device that can fail. Never rely on this mechanism as an excuse to point the nailer at yourself or any bystanders. Serious injury may occur.

5. **Without pressing the trigger**, depress the safety nose mechanism against a scrap piece of wood that is clean and free of any knots, nails, or other foreign objects.

— If the nailer does not fire, then the safety nose mechanism is working correctly.

— If the nailer **does fire** when you do this, immediately disconnect the nailer from the air supply and call Grizzly Technical Support at (570) 546-9663 for help.

— If the nailer fires when the trigger is pulled, without the safety nose mechanism being depressed, then the nailer is not working properly.

— If you find that the safety nose mechanism is not working properly, check the lubrication of its sliding components.

# OPERATIONS

## Loading

When replacing nails in your Model H5527, follow these guidelines:

Gauge: 18  
Length:  $\frac{5}{8}$ " – 2"  
Capacity: 100

To load your nailer:

1. DISCONNECT NAILER FROM THE AIR SUPPLY!
2. Grip the nailer firmly, and depress the magazine latch, as shown in **Figure 3**.

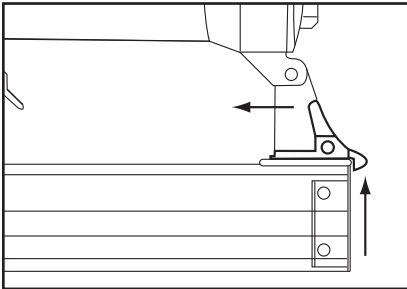

**Figure 3.** Releasing magazine latch.

3. Pull the magazine cover back until it stops.
4. Point the nailer down and insert a stick of brad nails into the magazine, as shown in **Figure 4**. Make sure that the pointed ends of the nails rest in the slot at the bottom of the magazine.

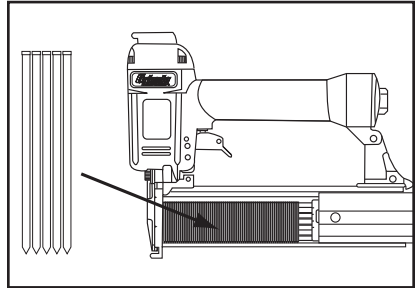

**Figure 4.** Loading nails into magazine.

5. Push the magazine cover forward until the magazine latch locks in place.

# Operating

---

---

**If you have not read the safety instructions in this manual, do not operate the nailer.**

Before you operate your nailer, place five to six drops of the included oil into the quick connect fitting where the nailer connects to the air supply.

## To operate your nailer:

1. Connect the air supply to the quick connect fitting.
2. To test for proper nail penetration, hold the nailer perpendicular to the surface of a piece of clean scrap wood that is thick enough for the length of nails you have loaded.
3. Depress the safety nose mechanism against your workpiece.
4. Before pulling the trigger, make sure your free hand and other body parts are positioned out of the way of a potential path of a nail in case of deflection.

Deflection is caused when grain irregularities, knots or foreign objects inside the wood cause the nail to change its path, resulting in the nail puncturing the surface of the workpiece, as shown in **Figure 5**.

Besides damaging your workpiece, deflection can cause injury if your free hand is securing the workpiece in the location that the nail deflects.

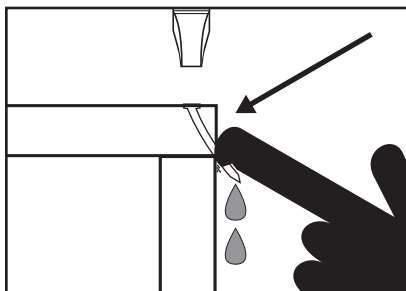

**Figure 5.** Example of nail deflection.

5. Pull the trigger.
  - If the nail drove into the wood far enough, continue with your intended operations.
  - If the nail either went too far or not far enough, then adjust the air pressure. More air pressure will make the nail go deeper and less air pressure will decrease the nail penetration.

## Clearing Jammed Nails

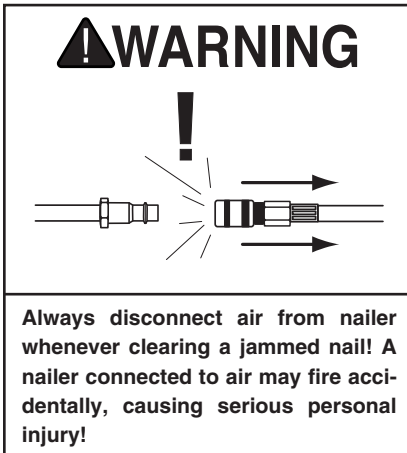

A jammed nail must be cleared before using the nailer again. The two places where a nail can get jammed are the magazine and the discharge area.

### To clear a jammed nail from the magazine:

1. DISCONNECT NAILER FROM THE AIR SUPPLY!
2. Open the magazine cover and pull the magazine all the way back.
3. Locate and remove the jammed nail with a pair of needle-nose pliers, then latch the magazine cover closed.

To clear a jammed nail from the discharge area:

1. DISCONNECT NAILER FROM THE AIR SUPPLY!
2. Remove the two cap screws that secure the driver guide cover to the driver guide on the nose assembly, as shown in **Figure 6**.

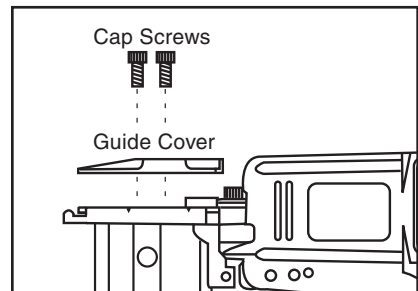

**Figure 6.** Nose opened to clear a jam.

3. The jammed nail should now be visible; remove it with needle nose pliers.
4. Re-install the guide cover and the two cap screws, and check the safety nose mechanism for proper operation (refer to **Safety Nose Mechanism** on **Page 8**).

# Replacing Pistons/O-Rings

If you use your nailer day in and day out, repair pistons are cheap insurance against wasted down time and lost profits, in the event that a piston or piston shaft becomes worn out.



## To replace a piston:

1. DISCONNECT NAILER FROM THE AIR SUPPLY!
2. Remove all nails from the magazine cartridge.
3. Remove the four cap screws on the back of the nailer, near the exhaust port.
4. Remove the cap.
5. The top of the piston should now be visible inside the cylinder, which is housed in the head of the nailer.

6. Open the nose cover as if to clear a jammed nail.
7. Watch the discharge area and push the top of the piston with your finger. You will see the piston shaft slide down the discharge area.
8. With a long flathead screwdriver or similarly shaped tool, push the piston shaft back inside the nailer until you can grip the piston head and remove it from the cylinder. (Be careful not to scratch the discharge area when pushing the piston shaft with the screwdriver.)
9. Place a new O-ring on the new piston and apply a thin film of the nailer lubricating oil on the O-ring.
10. Insert the new piston in the cylinder. Make sure that the grooves on the piston shaft line up with those on the guide at the bottom of the cylinder. The new piston should easily slide into the cylinder. **DO NOT force the piston into the cylinder!** If the piston is not easily inserted, double-check the alignment of the piston shaft with the grooves on the guide.
11. After the piston is inserted correctly, close the magazine. Replace the rear cap assembly and tighten the 4 cap screws.
12. For more assistance, or to install a complete O-ring set, refer to the appropriate breakdown diagram in the back of this manual for component locations.

# ACCESSORIES

**H3175**— $\frac{1}{4}$ " NPT Female, Quick Coupler

**H3176**— $\frac{1}{4}$ " NPT Male, Quick Coupler

**H3177**— $\frac{1}{4}$ " NPT Male, Plug

**H3178**— $\frac{1}{4}$ " NPT Female, Plug

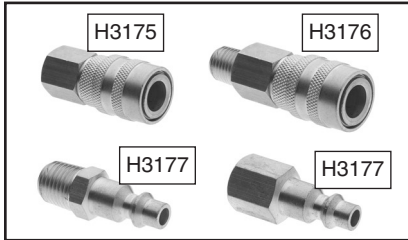

**Figure 7.**  $\frac{1}{4}$ " NPT air fittings.

**H3258**—Filter/Lube/Regulator  $\frac{3}{8}$ "NPT

**H3259**—Filter/Lube/Regulator  $\frac{1}{2}$ "NPT

These units are indispensable for prolonging the lifespan of your air tools. Filter keeps water/rust out. Lubricator features adjustable automatic lubrication. Regulator allows you to control the optimum PSI delivery for each air tool. Maximum pressure for each unit is 150 PSI.



**Figure 8.** Models H3258 & H3259 FilterLubricator/Regulators.

**G2820**—Pneumatic Tool Oil 8 oz.

**G2821**—Pneumatic Tool Oil 1 Pint

Use the right oil! This pneumatic tool oil offers outstanding heat displacement and friction reduction without eating away at delicate air components like detergent motor oils. Stock up with extra bottles to avoid costly downtime.

H5527 18 Gauge Brad Nailer

**G8114**— $\frac{3}{8}$ " x 25 Ft. Air Hose

**G8115**— $\frac{3}{8}$ " x 50 Ft. Air Hose

**G8116**— $\frac{3}{8}$ " x 100 Ft. Air Hose

Multi-purpose red rubber air hose is flexible and abrasion resistant. Rated for 200 PSI, this air hose has a bursting strength of 800 PSI  $\frac{1}{4}$ " NPT ends.

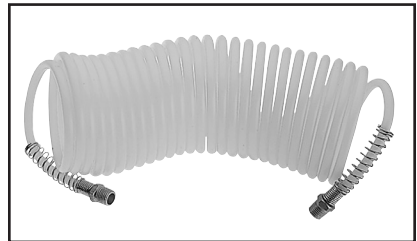

**Figure 9.** Red rubber air hose.

**H3275**— $\frac{1}{4}$ " x 25' Recoil Air Hose

**H3275**— $\frac{1}{4}$ " x 50' Recoil Air Hose

These recoil air hoses are ideal for nailers and staplers because they are light weight and offer maneuverability in tight places that is unmatched by rubber hoses. Coiled springs protect the ends from kinking. (Prices are less than you'll spend on lunch!)



**Figure 10.** Recoil air hose.

## Replacement Brad Nails

**G1853**—18 Gauge,  $\frac{5}{8}$ ", 5000

**G1854**—18 Gauge,  $\frac{3}{4}$ ", 5000

**G1855**—18 Gauge, 1", 5000

**G1858**—18 Gauge,  $1\frac{3}{8}$ ", 5000

**G1859**—18 Gauge,  $1\frac{1}{2}$ ", 5000

# CLEANING & LUBRICATION

## Cleaning

Use a good solvent to clean the nose assembly of the nailer. Always be sure that the nailer is dry before using it again.

Do not allow dust, chips, sand, etc. into the air connectors or into the body of the nailer; this may result in leaks and damage to the nailer and the air couplings.

**⚠ WARNING**



**Never use gasoline or other flammable liquids to clean this tool. Vapors in the tool may ignite, causing the tool to explode. Ignoring this warning may lead to serious personal injury or even death!**

## Lubricating

Special oil has been included with your new Grizzly nailer to help maintain its useful life. Place two to six drops of oil in the nailer air inlet (as shown in **Figure 11**) before every use, or after 2 hours of continuous use.

Wipe off any excess oil near the nailer exhaust to avoid dust build-up. When the oil that was included with the nailer has been completely used, replace with Grizzly Model G2820 Pneumatic Tool Oil.

Another option to manual oiling would be to install a lubricator in your air compressor line. If your air compressor line already has a lubricator, then regular lubrication of your nailer will not be necessary. Just make sure there is always oil in the lubricator.

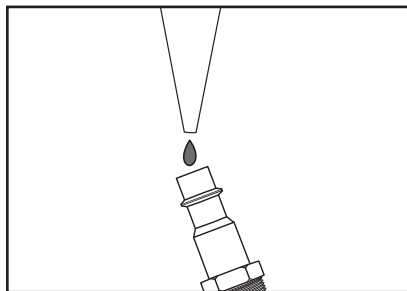

**Figure 11.** Lubricating nailer via air inlet.



# H5527 PARTS BREAKDOWN

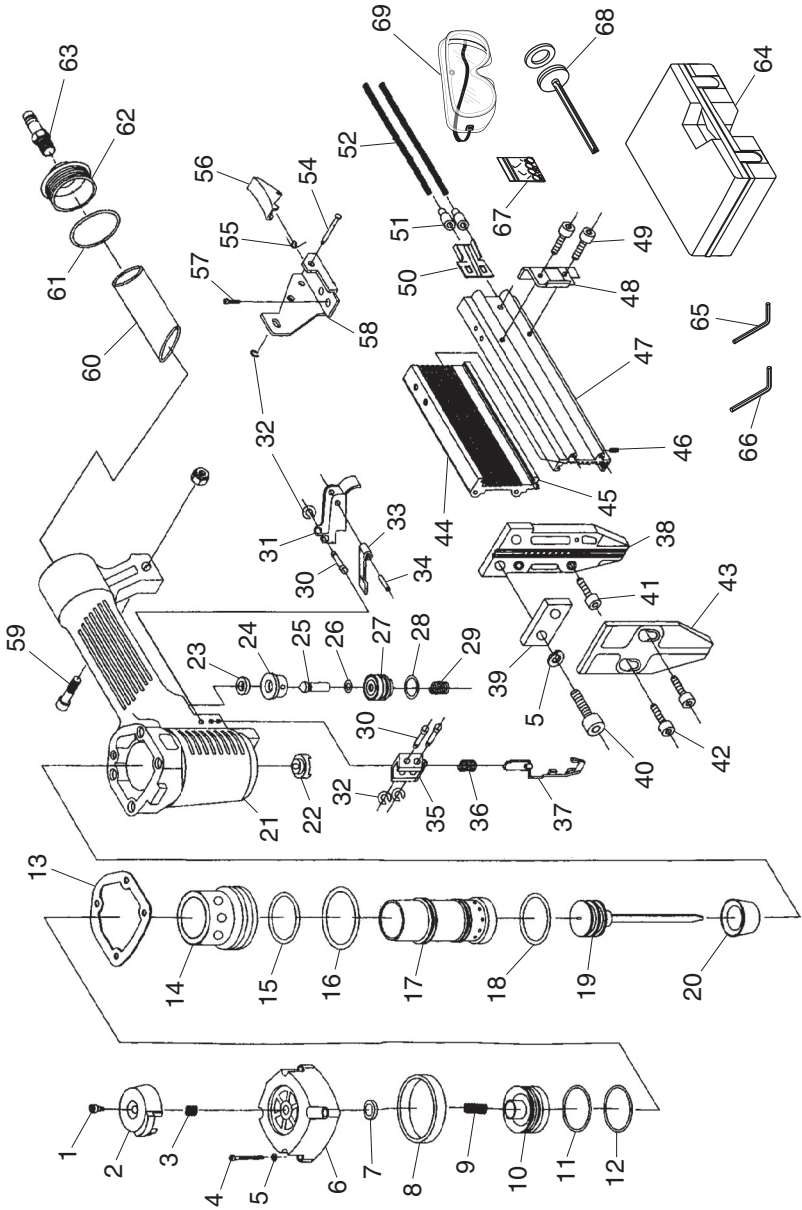

# H5527 PARTS LIST

REF	PART #	DESCRIPTION
1	PH5527001	STEPPED BOLT M5-.7 X 50
2	PH5527002	EXHAUST CAP
3	PH5527003	COMPRESSED SPRING 7.2 X 7
4	PSB15M	CAP SCREW M5-.8 X 20
5	PLW01M	LOCK WASHER 5MM
6	PH5527006	CYLINDER CAP
7	PORP014	O-RING 13.8 X 2.4 P14
8	PH5527008	SEALING WASHER 2.5 X 31.2
9	PH5527009	COMPRESSED SPRING 7.8 X 7
10	PH5527010	HEAD VALVE PISTON
11	PORP031-5	O-RING 31.2 X 3.5 P31.5
12	PORP025	O-RING 24.7 X 3.5 P25
13	PH5527013	SEALING WASHER 43 X 53.5
14	PH5527014	CYLINDER RING
15	PORP030	O-RING 29.7 X 3.5 P30
16	PORP042	O-RING 41.7 X 3.5 P42
17	PH5527017	CYLINDER
18	PORP021	O-RING 20.8 X 2.4 P21
19	PH5527019	PISTON (W/DRIVER)
20	PH5527020	BUMPER
21	PH5527021	BODY
22	PH5527022	RUBBER WASHER 4.5 X 8
23	PH5527023	SEAL
24	PH5527024	INNER VALVE SEAT
25	PH5527025	TRIG VALVE GUIDE
26	POR0011	O-RING 10.6 X 1.8
27	PH5527027	TRIGGER VALVE GUIDE
28	PORP011-2	O-RING 11 X 2.4 P11.2
29	PH5527029	COMPRESSED SPRING 9.1 X 17.5
30	PH5527030	STEP PIN
31	PH5527031	TRIGGER
32	PEC01M	E-CLIP 3MM
33	PH5527033	SAFETY PLATE
34	PH5527034	PIN

REF	PART #	DESCRIPTION
35	PH5527035	STAND
36	PH5527036	SPRING 5.3 X 21
37	PH5527037	SAFETY STAND
38	PH5527038	DRIVER GUIDE
39	PH5527039	SPACER
40	PSB15M	CAP SCREW M5-.8 X 20
41	PSB23M	CAP SCREW M4-.7 X 12
42	PSB17M	CAP SCREW M4-.7 X 10
43	PH5527043	DRIVER GUIDE COVER
44	PH5527044	NAIL GUIDE LINER
45	PH5527045	MAGAZINE SEAT
46	PSS35M	SET SCREW M4-.7 X 16
47	PH5527047	MAGAZINE CAP
48	PH5527048	BRACKET
49	PSB41M	CAP SCREW M4-.7 X 14
50	PH5527050	PUSHER
51	PH5527051	PUSHER PIPE
52	PH5527052	COMPRESSED SPRING 6.7 X 204
54	PH5527054	PIN
55	PH5527055	LATCH SPRING 6.2 X 9.4
56	PH5527056	LATCH
57	PSB18M	CAP SCREW M4-.7 X 8
58	PH5527058	LATCH BRACKET
59	PSB16M	CAP SCREW M4-.7 X 16
60	PH5527060	RUBBER SLEEVE
61	PORP036	O-RING 35.7 X 3.5 P36
62	PH5527062	CAP
63	PH5527063	AIR PLUG 1/4" NPT MALE
64	PH5527064	CARRYING CASE
65	PAW05M	HEX WRENCH 5MM
66	PAW04M	HEX WRENCH 4MM
67	PH5527067	COMPLETE O-RING KIT
68	PH5527068	PISTON REPAIR KIT
69	PH5527069	SAFETY GLASSES

# TROUBLESHOOTING

Symptom	Possible Cause	Solution
Air leaking at trigger valve area.	1. O-rings in trigger valve housing are damaged.	1. O-rings must be replaced & operation of safety nose must be checked.
Air leaking between housing and hose.	1. Loose screws in housing. 2. Damaged O-ring. 3. Loose air fitting.	1. Tighten screws. 2. Replace O-ring. 3. Tighten air fitting & use teflon tape.
Air leaking between housing and cap assembly.	1. Damaged seal.	1. Replace damaged seals.
Tool skips nails while discharging.	1. Air leaks. 2. Dirt in nose. 3. Dirt or damage prevents nails from moving freely in magazine. 4. Inadequate air flow to tool.  5. Worn O-ring on piston or lack of lubrication. 6. Damaged O-rings on trigger valve. 7. Worn bumper. 8. Cap seal leaking.	1. Tighten screws and fittings. 2. Clean nose. 3. Clean magazine and inspect/repair damage.  4. Check air fitting, hose, compressor & air pressure. 5. Replace piston O-ring. Lubricate. 6. Replace trigger valve O-rings. 7. Replace bumper. 8. Replace cap seal.
Tool runs slowly or has a loss of power.	1. Nailer is not sufficiently lubricated. 2. Broken spring in cap assembly. 3. Exhaust port in cap is blocked.	1. Lubricate nailer. 2. Replace spring. 3. Clean or replace damaged internal parts.
Fasteners frequently jam the nailer.	1. Nails are the wrong size. 2. Nails are bent or dirty.  3. Magazine or nose screws are loose. 4. Driver or driver guide are worn or damaged. 5. Nails are wrong angle.	1. Use correct nails. 2. Use undamaged, clean nails. 3. Tighten magazine.  4. Replace worn or damaged parts. 5. Use correct angle nails.
Nailer does not fire.	1. Nail is jammed in magazine or discharge area. 2. Piston shaft is damaged. 3. Air pressure too low.	1. Clear nailer magazine or discharge area. 2. Replace piston shaft. 3. Check/increase air pressure.

# WARRANTY AND RETURNS

---

---

Grizzly Industrial, Inc. warrants every product it sells for a period of **1 year** to the original purchaser from the date of purchase. This warranty does not apply to defects due directly or indirectly to misuse, abuse, negligence, accidents, repairs or alterations or lack of maintenance. This is Grizzly's sole written warranty and any and all warranties that may be implied by law, including any merchantability or fitness, for any particular purpose, are hereby limited to the duration of this written warranty. We do not warrant or represent that the merchandise complies with the provisions of any law or acts unless the manufacturer so warrants. In no event shall Grizzly's liability under this warranty exceed the purchase price paid for the product and any legal actions brought against Grizzly shall be tried in the State of Washington, County of Whatcom.

We shall in no event be liable for death, injuries to persons or property or for incidental, contingent, special, or consequential damages arising from the use of our products.

To take advantage of this warranty, contact us by mail or phone and give us all the details. We will then issue you a "Return Authorization Number," which must be clearly posted on the outside as well as the inside of the carton. We will not accept any item back without this number. Proof of purchase must accompany the merchandise.

The manufacturers reserve the right to change specifications at any time because they constantly strive to achieve better quality equipment. We make every effort to ensure that our products meet high quality and durability standards and we hope you never need to use this warranty.

Please feel free to write or call us if you have any questions about the machine or the manual.

**Grizzly Industrial, Inc.**  
**1203 Lycoming Mall Circle**  
**Muncy, PA 17756**  
**Phone: (570) 546-9663**  
**Fax: (800) 438-5901**

**E-Mail:**  
**techsupport@grizzly.com**

**Web Site: <http://www.grizzly.com>**

Thank you again for your business and continued support. We hope to serve you again soon!