

Instructions



Important Safety Instructions

Read all warnings and instructions in this manual.
Save these instructions.



311082B

Pressure Roller with 20-inch Fixed Extension

- For application of architectural paints and coatings -

Model 287713, Series A

- 20 inch (50 cm) heavy-duty extension
- 9 inch (23 cm) roller frame
- 1/2 inch (13 mm) nap roller cover

*3600 psi (24.8 MPa, 248 bar) Maximum Working Pressure**

*The best operating pressure is the lowest pressure that provides an even paint supply to the roller and typically does not exceed 300 psi (2.1 MPa, 21 bar).

CAUTION

Never leave water in pump, gun or pressure roller. Doing so could cause corrosion and damage from freezing. For storage, flush the system with Pump Defender™ or mineral spirits/paint thinner.

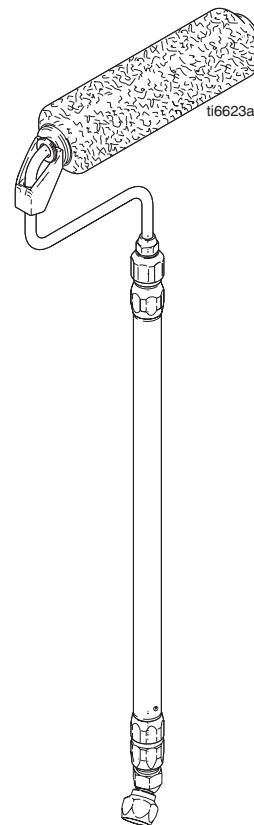







PROVEN QUALITY. LEADING TECHNOLOGY.





Warnings

The following warnings are for the safe setup, use, grounding, maintenance, and repair of this equipment. The exclamation point symbol alerts you to a general warning and the hazard symbols refer to procedure-specific risks. Refer back to these Warnings. Additional, product-specific warnings may be found throughout the body of this manual where applicable.

 WARNING	
	<p>EQUIPMENT MISUSE HAZARD</p> <p>Misuse can cause death or serious injury.</p> <ul style="list-style-type: none"> • Do not operate the unit when fatigued or under the influence of drugs or alcohol. • Do not exceed the maximum working pressure or temperature rating of the lowest rated system component. See Technical Data in all equipment manuals. • Use fluids and solvents that are compatible with equipment wetted parts. See Technical Data in all equipment manuals. Read fluid and solvent manufacturer's warnings. For complete information about your material, request MSDS forms from distributor or retailer. • Check equipment daily. Repair or replace worn or damaged parts immediately with genuine manufacturer's replacement parts only. • Do not alter or modify equipment. • Use equipment only for its intended purpose. Call your distributor for information. • Route hoses and cables away from traffic areas, sharp edges, moving parts, and hot surfaces. • Do not kink or over bend hoses or use hoses to pull equipment. • Keep children and animals away from work area. • Comply with all applicable safety regulations.
 	<p>SKIN INJECTION HAZARD</p> <p>High-pressure fluid from gun, hose leaks, or ruptured components will pierce skin. This may look like just a cut, but it is a serious injury that can result in amputation. Get immediate surgical treatment.</p> <ul style="list-style-type: none"> • Do not point gun at anyone or at any part of the body. • Do not put your hand over the spray tip. • Do not stop or deflect leaks with your hand, body, glove, or rag. • Do not spray without tip guard and trigger guard installed. • Engage trigger lock when not spraying. • Follow Pressure Relief Procedure in this manual, when you stop spraying and before cleaning, checking, or servicing equipment.
	<p>PRESSURIZED EQUIPMENT HAZARD</p> <p>Fluid from the gun/dispense valve, leaks, or ruptured components can splash in the eyes or on skin and cause serious injury.</p> <ul style="list-style-type: none"> • Follow Pressure Relief Procedure in this manual, when you stop spraying and before cleaning, checking, or servicing equipment. • Tighten all fluid connections before operating the equipment. • Check hoses, tubes, and couplings daily. Replace worn or damaged parts immediately.
	<p>PERSONAL PROTECTIVE EQUIPMENT</p> <p>You must wear appropriate protective equipment when operating, servicing, or when in the operating area of the equipment to help protect you from serious injury, including eye injury, inhalation of toxic fumes, burns, and hearing loss. This equipment includes but is not limited to:</p> <ul style="list-style-type: none"> • Protective eyewear • Clothing and respirator as recommended by the fluid and solvent manufacturer • Gloves • Hearing protection

Pressure Relief Procedure

							
<p>Follow this Pressure Relief Procedure when you stop spraying and before cleaning, checking, servicing, or transporting equipment.</p>							

1. Turn power switch OFF and unplug sprayer power cord.

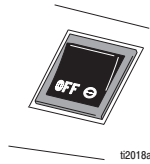

2. Turn spray/prime valve to PRIME to relieve pressure.



3. Hold metal part of gun firmly to side of a grounded metal pail. Trigger gun.



4. Engage trigger lock.

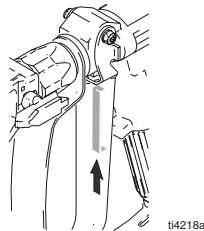



If you suspect the spray tip or hose is clogged or that pressure has not been fully relieved after following the steps above, VERY SLOWLY loosen tip guard retaining nut or hose end coupling to relieve pressure gradually, then loosen completely. Clear hose or tip obstruction.

Trigger Lock

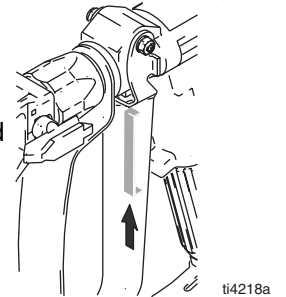
Always engage the trigger lock when you stop spraying to prevent the gun from being triggered accidentally by hand or if dropped or bumped.





Operation

							
---	--	--	--	--	--	--	--

1. Follow pump priming instructions provided in your sprayer operation manual using the lowest pressure setting at which the pump primes.
2. Turn prime/spray valve to SPRAY position.



3. Disengage gun safety latch. Trigger gun and begin rolling surface until paint comes to roller.
 -  Trigger gun briefly only when you need more paint. Determine how often you must trigger the gun to maintain an even supply of paint to the roller.
4. If triggering gun cannot supply enough paint for your rolling speed, increase pump pressure.

							
---	--	--	--	--	--	--	--

-  When you stop painting, **relieve pressure**, page 3. Elevate roller end of extension tube to prevent paint from draining out.
5. Flush pump, gun and pressure roller immediately after each use to prevent paint from drying in the pressure roller and damaging it. See Cleaning, page 4.

Cleaning

This is the procedure for flushing/cleaning the pressure roller. The sprayer and gun you are using may have additional flushing/cleaning instructions; such as cleaning filters and screens. See sprayer and gun operation manuals.



- Leave pressure roller attached to gun for this procedure.
- Refer to roller parts drawing, page 5.

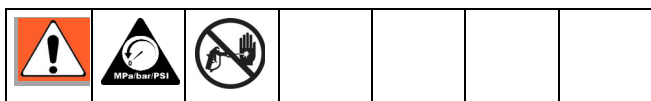

1. **Relieve pressure**, page 3.
2. Remove roller cover (13) and diffuser (23) from roller frame (1) as follows:
 - a. Using your thumb, press down on clip (5) to release end caps (2 & 4), diffuser, (23) and roller cover (19) into pail.
 - b. Remove roller cover (19) from diffuser (23).
 - c. Pull end caps (2 & 4) off diffuser (23).
3. Clean roller cover (19), caps (2 & 4) and diffuser (19) with water or a compatible fluid for oil-based materials.

4. Place roller frame (1) in paint pail. Be sure the holes in roller frame (1) are facing inside paint pail.
5. Prime pump with water or flushing fluid for oil-based materials. Use the lowest pump pressure setting.
6. Turn prime/spray valve to SPRAY.



Perform Step 7 at the lowest pressure possible.

7. Trigger gun until flushing fluid begins to dilute the paint.
8. Place roller frame (1) in another bucket and continue flushing until fluid coming out of roller frame (1) is clear.
9. Shut off pump. Turn prime/spray valve to PRIME.

Storage

If you are going to store the airless equipment for an extended period of time after flushing with water-based fluid, flush again with Pump Defender™ or mineral spirits/paint thinner. Leave the fluid in the system during storage.

Parts

Ref. No.	Part No.	Description	Qty.
1	15B052	FRAME, roller	1
2	245999	CAP, end (includes seal and retainer)	1
4	246277	CAP, end (includes seal, retainer, and o-ring)	1
5	197106	CLIP, roller	1
6	197118	FITTING, swivel	1
7	162863	GASKET	2
8	114049	O-RING	2
9	197117	NUT, retaining	1
12	704-25G	FITTING, extension, male	1
13	15A619	GASKET	1
14	7422R	EXTENSION, 20-inch, (50 cm)	1
15	7551G	FITTING, extension, female	1
16	195804	LABEL, warning	1
19	7722	ROLLER, cover, 9-inch, 1/2 inch (13mm) nap	1
20	115524	GASKET	1
23	15B065	DIFFUSER	2
25	239531	UNION, swivel, 45°	1

▲ Replacement Danger and Warning labels, tags, and cards are available at no cost.

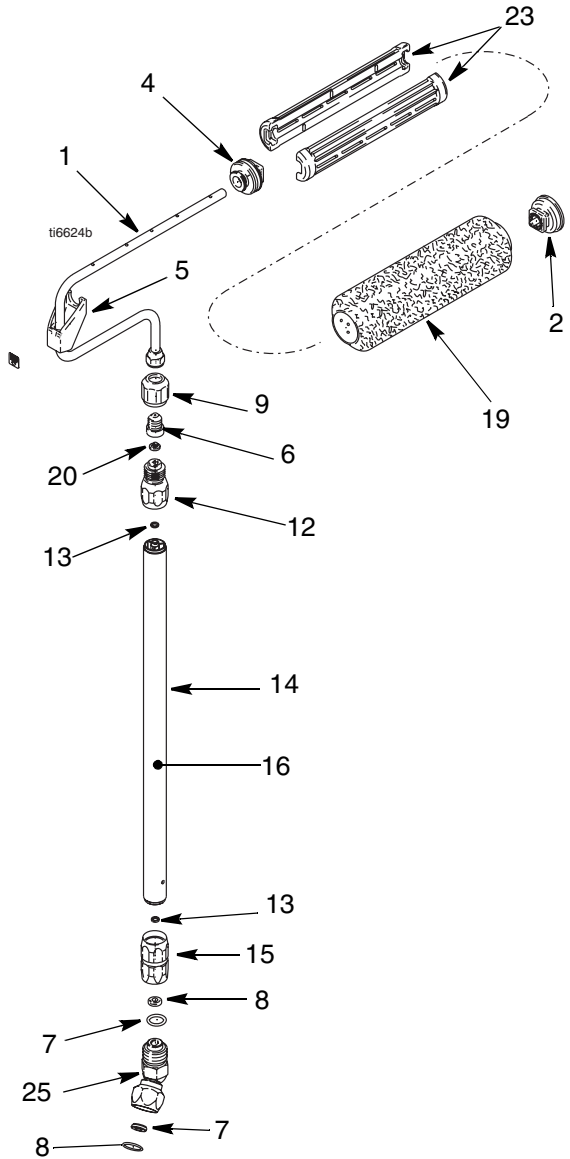

ASM Standard Warranty

ASM warrants all equipment referenced in this document which is manufactured by ASM and bearing its name to be free from defects in material and workmanship on the date of sale by an authorized ASM distributor to the original purchaser for use. With the exception of any special, extended, or limited warranty published by ASM, ASM will, for a period of twelve months from the date of sale, repair or replace any part of the equipment determined by ASM to be defective. This warranty applies only when the equipment is installed, operated and maintained in accordance with ASM's written recommendations.

This warranty does not cover, and ASM shall not be liable for general wear and tear, or any malfunction damage or wear caused by faulty installation, misapplication, abrasion, corrosion, inadequate or improper maintenance, negligence, accident, tampering, or substitution of non-ASM component parts. Nor shall ASM be liable for malfunction, damage, or wear caused by the incompatibility of ASM equipment with structures, accessories, equipment or materials not supplied by ASM, or the improper design, manufacture, installation, operation or maintenance of structures, accessories, equipment or materials not supplied by ASM.

This warranty is conditioned up the prepaid return of the equipment claimed to be defective to an authorized ASM distributor for verification of the claimed defect. If the claimed defect is verified, ASM will repair or replace free of charge any defective parts. The equipment will be returned to the original purchaser transportation prepaid. If inspection of the equipment does not disclose any defect in material or workmanship, repairs will be made at a reasonable charge, which charges may include the costs of parts, labor, and transportation.

THIS WARRANTY IS EXCLUSIVE, AND IS IN LIEU OF ANY OTHER WARRANTIES, EXPRESS OR IMPLIED, INCLUDING BUT NOT LIMITED TO WARRANTY OF MERCHANTABILITY OR WARRANTY OF FITNESS FOR A PARTICULAR PURPOSE.

ASM's sole obligation and buyer's sole remedy for any breach of warranty shall be set forth above. The buyer agrees that no other remedy (including, but not limited to, incidental or consequential damages for lost profits, lost sales, injury to person or property, or any other incidental or consequential loss) shall be available. Any action or breach of warranty must be brought within two (2) years of the date of sale.

ASM MAKES NOT WARRANTY, AND DISCLAIMS ALL IMPLIED WARRANTIES OF MERCHANTABILITY AND FITNESS FOR A PARTICULAR PURPOSE, IN CONNECTION WITH ACCESSORIES, EQUIPMENT, MATERIALS OR COMPONENTS SOLD BUT NOT MANUFACTURED BY ASM. These items sold, but not manufactured by ASM (such as electric motors, switches, hose, etc.), are subject to the warranty, if any, of their manufacturer. ASM will provide purchaser with reasonable assistance in making any claim for breach of these warranties.

In no event will ASM be liable for indirect, incidental, special or consequential damages resulting from ASM supplying equipment hereunder, or the furnishing, performance, or use of any products or other goods sold hereto, whether due to a breach of contract, breach of warranty, the negligence of ASM, or otherwise.

*TO PLACE AN ORDER OR FOR SERVICE, contact your ASM distributor,
or call 1-800-285-0032.*

All written and visual data contained in this document reflects the latest product information available at the time of publication.
ASM reserves the right to make changes at any time without notice.

Manufactured by ASM Company; a division of Graco Inc.
ASM Company, 3500 North 1st Avenue, Sioux Falls, SD 57104

<http://www.asmcompany.com>

PRINTED IN U.S.A. 311082
4/2005, Revised 4/2006