

GRACO®

Open Top Swing

OWNER'S MANUAL

Model No. _____
Serial No. _____

Dear Customer,

Please fill in the model and serial numbers above from the label inside the battery compartment of your new swing.

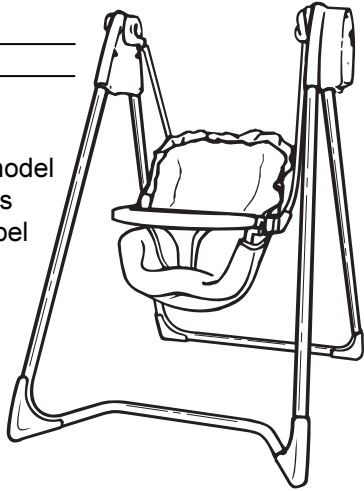

Model No. 1434, 1444 or 1452

Congratulations on your purchase of a Graco® swing!

Graco is the recognized leader in the design and manufacture of quality baby swings. We believe your new Graco® swing is a wise choice, promising many hours of enjoyment for your baby.

Before using your swing, please take a few minutes to read this Owner's Manual. The short time you spend reading these instructions will help you use your swing properly.

Please save your Owner's Manual for future use.

Customer Satisfaction

Our goal is to make every product the best it can be! We are also committed to supporting our products after purchase. If you would like to speak to Graco about your product, please contact our **Customer Service Department at 1-800-345-4109**. Our knowledgeable staff will be ready to answer any questions you may have concerning parts, use, or maintenance. When you call, please have the **model and serial numbers** ready so your call may be processed quickly and efficiently.

⚠ WARNING

Failure to follow these warning instructions could result in serious injury or death.

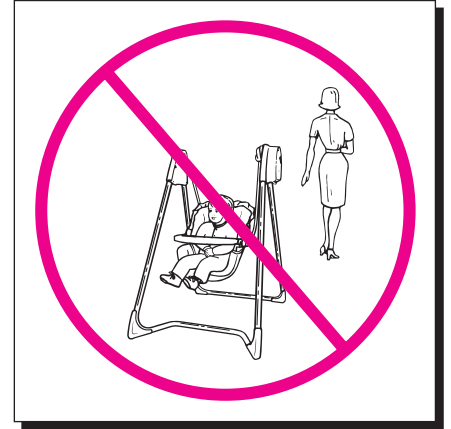

Never leave child unattended. Always keep your child in view.



Strings can cause strangulation. DO NOT place items with a string around your child's neck, such as hood strings or pacifier cords. DO NOT suspend strings over the swing or attach strings to toys.

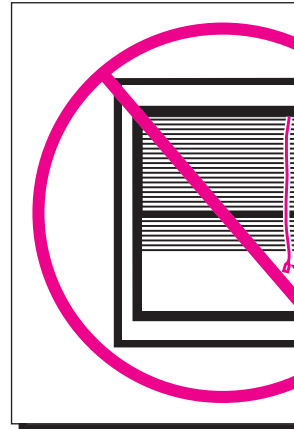

STRANGULATION HAZARD
DO NOT place swing in a location where there are cords or drapes, such as window blinds, drapes, phone cords, etc.

THIS PRODUCT REQUIRES ADULT ASSEMBLY.

FOLLOW ASSEMBLY INSTRUCTIONS CAREFULLY.

If you experience any difficulties, please contact the Customer Service Department.

DO NOT USE SWING without the seat cover.

DISCONTINUE USING YOUR SWING should it become damaged or broken.

WARNING

Read the warnings and the assembly instructions carefully. Failure to do so may result in serious injury or death.

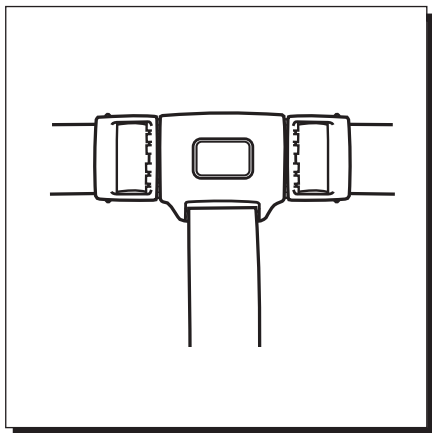

Avoid serious injury from falling or sliding out. Always use seat belt.

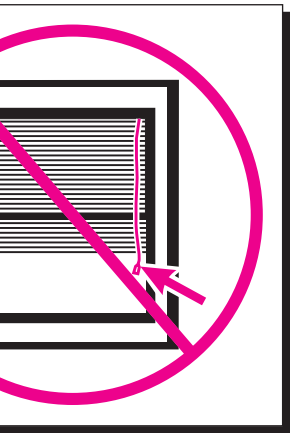

REGULATION HAZARD: Do not place swing in any area where there are cords, window blind cords, telephone cords, etc.



DO NOT use if child weighs over 25 pounds (11.3 kg) or becomes too active to safely use the swing.

CARE AND MAINTENANCE

FROM TIME TO TIME CHECK YOUR SWING for loose screws, worn parts, torn material or stitching. Replace or repair the parts as needed. Use only Graco® replacement parts.

REMOVABLE CLOTH SEAT COVER (on certain models) may be machine washed in lukewarm water on delicate cycle and drip-dried. **NO BLEACH.**

TO CLEAN SWING FRAME, use only household soap or detergent and warm water. **NO BLEACH.**

EXCESSIVE EXPOSURE TO SUN OR HEAT could cause fading or warping of parts.

PARTS LIST

CHECK that you have all the parts listed below BEFORE assembling your swing. If any parts are missing, call Customer Service at 1-800-345-4109.

Tools required: Screwdriver

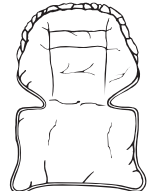

Seat cover

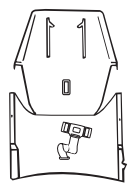

Plastic seat with crotch strap

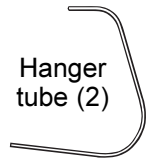

Hanger tube (2)

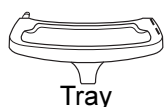

Tray

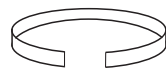

Seat belt



Plastic leg tip (4)

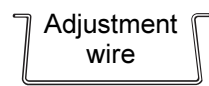

Adjustment wire

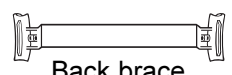

Back brace



Screw (4)

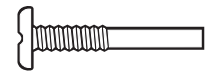

Pin screw (2)

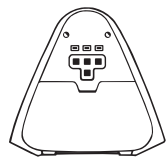

Motor housing

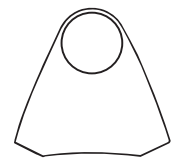

Pivot housing



Large front foot (2)



Small rear foot (2)

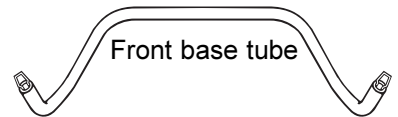

Front base tube

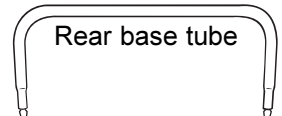

Rear base tube



Leg (4)

Attaching the Legs

Step 1.

The four legs have a double button at one end and a single button beneath it.

With the hub sides facing up, place the motor housing and pivot housing on the floor. Position legs so their single buttons also face up.

Insert legs into the motor housing and pivot housing as shown. **The double buttons must fit into the channels inside the housings.**

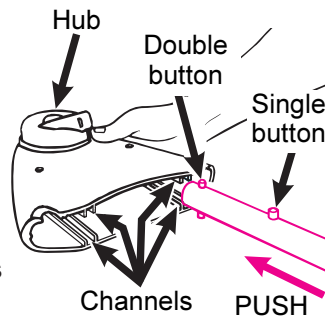

Step 2.

Push each leg in until the double button snaps into the hole at the end of the channel. Then swing the legs outward until the single button snaps into its notch, as shown.

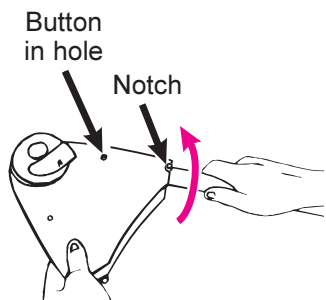

CHECK that the legs are properly attached by twisting them in the housings. They should resist twisting. If a leg twists and buttons come out of their holes, insert leg into the housing again. Be sure to align BOTH double buttons with BOTH sets of channels inside the housings.

Attaching the Feet

Step 1.

Identify the front and rear base tubes from pictures at right. The feet to use with each tube can be identified by the text "FRONT BOTTOM" or "REAR BOTTOM" printed on them.

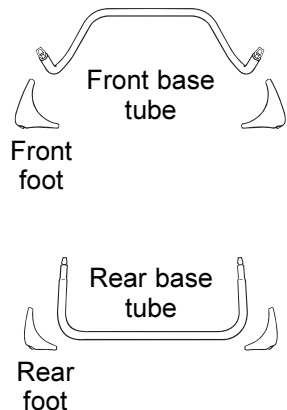

Step 2.

Begin by inserting a screw all the way into the small hole on one foot. Position the foot as **shown at right**, so the text and viewing hole are **not** on the **short side of tube** near the wire end. Then use viewing hole to line up the end of the screw with the hole in the tube. Tighten the screw securely. Repeat above steps for the other feet.

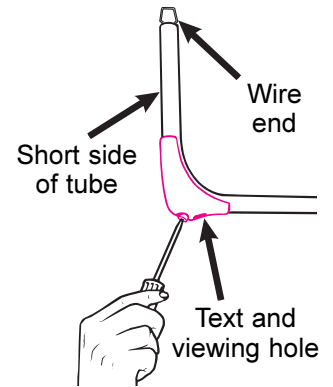

CHECK that feet are secure by wiggling the feet.

Step 3.

Push a plastic tip onto all four of the feet. Tap leg tips on the floor to be sure they are completely on.

NOTE: The hole in the plastic tip permits future tightening of the screw if needed.

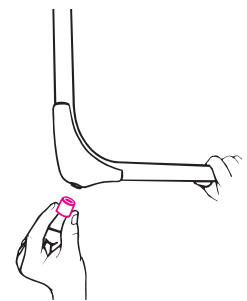

Attaching the Base Tubes

Step 1.

Push the legs firmly onto the rear base tube **exactly as shown**.

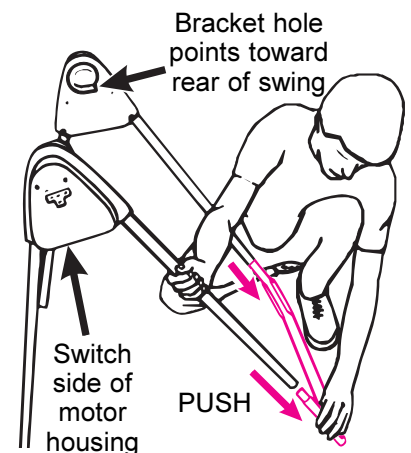

Step 2.

Push the other two legs onto the front base tube.

CHECK that all tubes are securely attached.

CHECK that the parts of the frame are assembled in the positions shown.

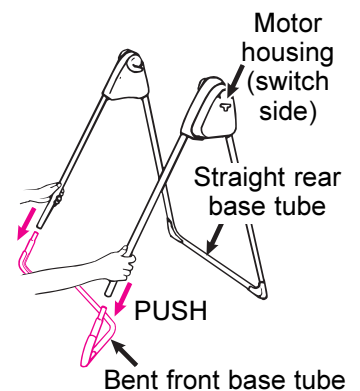

Attaching the Hanger Tubes and Seat

Step 1.

Move seat back fully forward onto seat armrests.

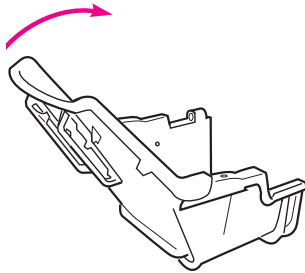

NOTE: The seat back must overlap the armrests.

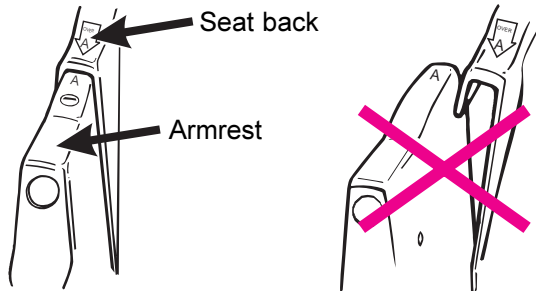

Step 2.

Slide hanger tubes into armrests of seat as shown.

Then insert two pin screws through seat armrests into the holes in the hanger tubes and tighten securely.

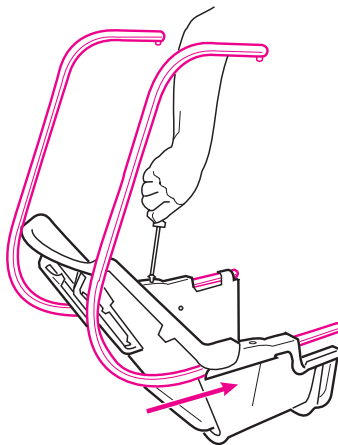

Step 3.

Insert the hanger tubes into the hubs as shown. Metal buttons should pop out and lock upon full insertion.

CHECK that the hanger tubes are secure in hubs by pulling firmly on them.

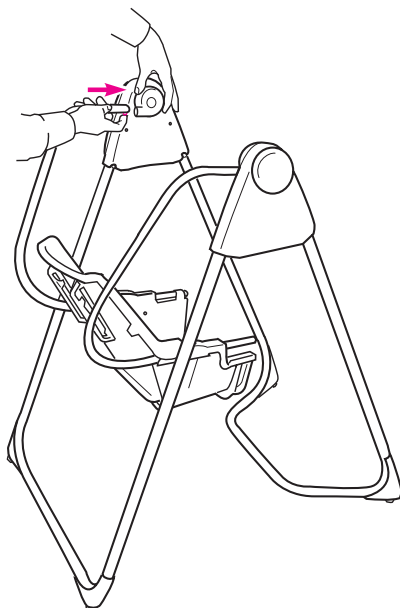

Attaching the Back Brace

Working behind the seat, snap the four pins in the ends of the plastic back brace into the holes in the hanger tubes. The word "REAR" should be facing you.

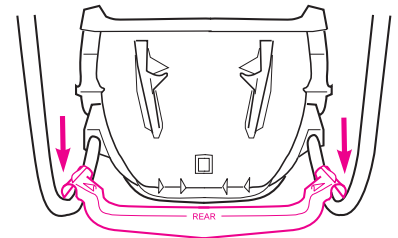

Slide adjustment wire through openings in seat back, then insert ends into back brace holes as shown.

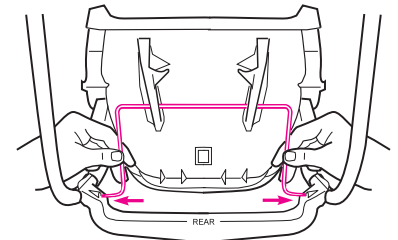

Be sure the back brace is securely attached by pulling on it.

Attaching the Tray

Slide the tray onto the hanger tube, then push sleeve of tray all the way into the armrest of the seat.

Sleeve on tray must snap completely into the armrest.

Pull on tray to be sure it is securely attached.

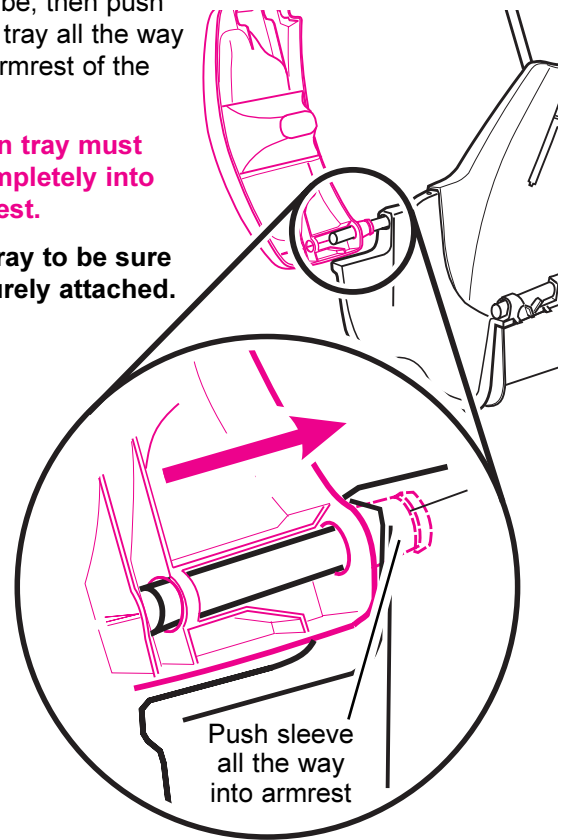

Attaching the Seat Belt

Step 1.

Thread one end of the seat belt through the belt retainer as shown.

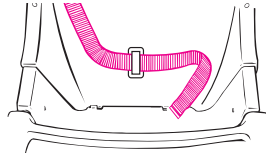

Step 2.

Thread both ends of seat belt through the buckles as shown.

CHECK that the belt is threaded correctly by pulling on the seat belt. **The belt should not slip through the buckle.**

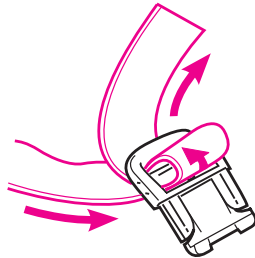

To release, push in on front of buckle.

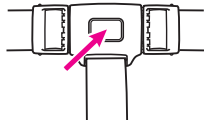

To Use Head Supports (on certain models)

To provide head support for a smaller child, insert the two head support pads into the pockets located in the back of the cloth seat pad.

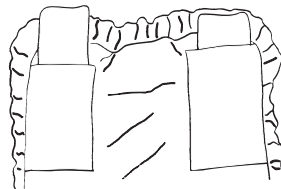

Back of cloth seat pad

Attaching the Seat Cover

Step 1.

Slide the pocket of the seat cover over the top of the seat as shown.

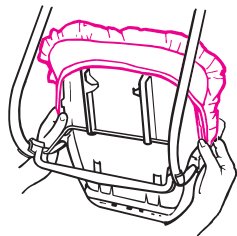

Step 2.

Pull the crotch strap and both ends of the seat belt through the slots in the seat cover.

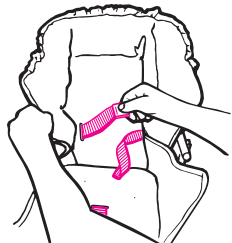

Step 3.

Push the elastic loop through the hole on one side of seat.

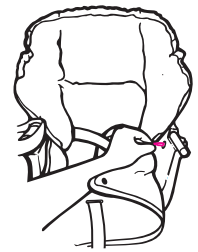

Step 4.

Fold cover around bottom of seat. Then fasten the hook into the elastic loop on one side as shown. Repeat on other side.

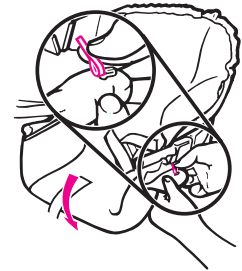

CAUTION: Be sure the seat cover at armrest does not interfere with tray latching.

Using the Tray

NOTE: If tray does not latch, check back brace to be sure the word "REAR" is away from the seat.

Step 1.

Unlatch the tray by squeezing the two latches under the tray at the same time, and lift up. **Be careful** not to let the tray hit your baby when lifting or closing the tray.

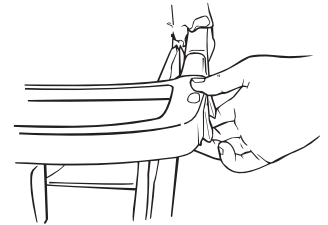

Step 2.

To latch tray, push it down firmly.

▲WARNING Tray must be latched at all times when baby is in swing. Pull up on tray to be sure it is latched.

Reclining Back—Four Positions

Pull adjustment wire upward and pull seat backward to recline seat. Extra pressure is required to go from the third position to full recline.

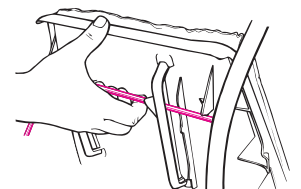

For upright position, simply lift back of seat forward.

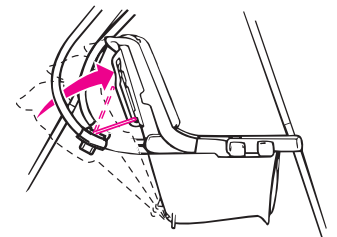

Installing the Batteries

Step 1.

With baby out of swing, open the battery compartment lid by inserting a coin (penny, nickel or dime) into the coin slot. After the lid pops open, swing it down and remove it.

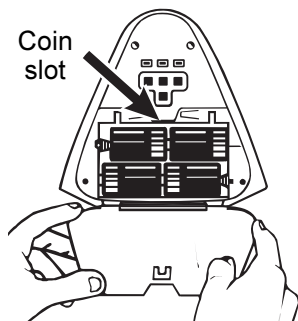

Step 2.

Insert four "D" cells. **CHECK** that the batteries are put in correctly. Your swing will not run if the batteries are put in backwards.

Step 3.

To replace lid, put the two tabs of the lid into the two slots in the bottom of the motor housing. Swing lid up, and press it into place until you hear the latch click.

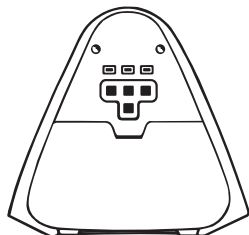

Starting the Swing

CHECK that all parts are securely fastened together before using the swing.

Step 1.

Open tray and seat belt. Place baby in the seat. (If your child is very small, you may want to use rolled-up blankets as a prop.)

Step 2.

Fasten the seat belt. Adjust belt as needed to get a snug fit around your child.

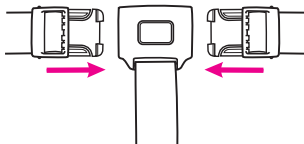

Step 3.

Close the tray. **CHECK that the tray is latched by pulling up on the tray.**

⚠ WARNING Do not depend on the tray or seat belt alone to hold your baby. Always secure your baby with both the seat belt and tray when your child is in the swing.



Step 4.

To start swing, push the desired speed button and give the swing a gentle push.

- Push "1" for the lowest ride.
- Push "2" for medium ride.
- Push "3" for the highest ride.

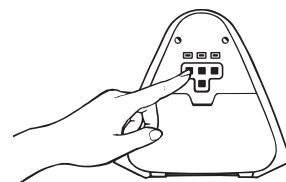

Observe the swinging motion for a minute. It takes time for the swing to adjust to a setting. Change setting as needed.

NOTE: A small, quiet baby will swing higher on each setting than a larger, more active baby.

Step 5.

To turn swing off:

On models without music, push the OFF button.

OR

On models with music, push the active speed button.

Indicator light will go off and swing will stop.

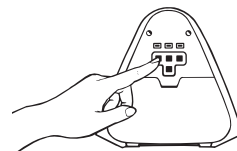
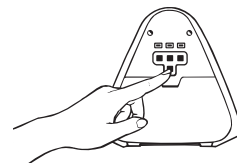

Indicator Light-
Red light comes on when swing is turned on.

NOTE: SEAT MAY BE STOPPED ANY TIME MOTOR IS RUNNING WITHOUT DAMAGING MOTOR. PUSH SWING TO RESTART.

IF YOUR SWING MOTOR STOPS OPERATING BY ITSELF, PROTECTIVE DEVICE MAY HAVE BEEN ACTIVATED. TURN OFF MOTOR, WAIT 3 MINUTES, THEN RESTART SWING.

To Use Music (on certain models)

If you want music for your baby, push the music button until desired volume is reached:

- Push once for high volume.
- Push a second time for medium volume.
- Push a third time for low volume.
- Push a fourth time to turn music off.

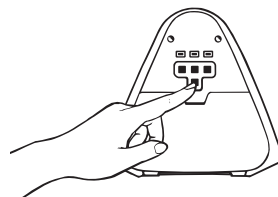

NOTE: The music control is independent of the speed setting. You can have any combination of speed and music settings.

FOR SAFE BATTERY USE:

Keep the batteries out of children's reach.

Any battery may leak electrolyte if mixed with a different battery type, if inserted incorrectly (put in backwards) or if all batteries are not replaced or recharged at the same time.

Any battery may leak electrolyte or explode if disposed of in fire or an attempt is made to charge a battery not intended to be recharged. Never recharge a cell of one type in a recharger made for a cell of another type.

Discard leaky batteries immediately. Leaky batteries can cause skin burns or other personal injury. When discarding batteries, be sure to dispose of them in the proper manner, according to your state and local regulations.

Always remove batteries if the swing is not going to be used for a month or more. Batteries left in the unit may leak and cause damage.

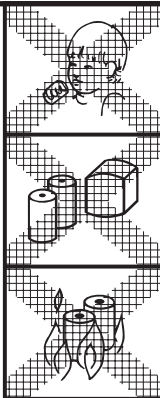

Recommended Type Batteries—Size D

- Rechargeables—Use and recharge according to manufacturer's instructions.
- Disposables—Alkaline.
- **NEVER** mix battery types.

Operation: 3 speed settings:

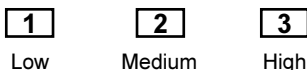

Indicator lights blink on and off when batteries are becoming weak. Change batteries when swing ceases to operate satisfactorily.

Caring for Your Battery Powered Swing

Problem: Possible Reasons for Problem:

Swing won't operate

1. No batteries in swing.
2. Batteries dead.
3. Speed setting too low.
4. Batteries in backwards—check "+" and "-".
5. Corrosion on battery terminals. Rotate batteries in place against terminals, or clean with sandpaper or steel wool if corrosion is severe.
6. Baby leaning too far forward.
7. Baby grabbing swing legs. (Discontinue use.)
8. Seat not pushed high enough for a good start.
9. Protective device activated. (Turn off motor, wait 3 minutes, then restart swing.)

Seat doesn't swing very high

1. Control setting too low.
2. Blanket hanging down, causing increased wind resistance.
3. Batteries too weak.
4. Baby leaning too far forward.
5. Baby too heavy or too active. (Discontinue use.)
6. Soft carpet (swings higher on hard floors).

If you still have problems, call our toll-free number, 1-800-345-4109.

Replacement Parts

Instructions for ordering swing parts:

Complete form below. Your swing model number **MUST** be included on the form to ensure proper replacement parts. Your model number can be found on a sticker beneath the swing motor. **Payment must accompany your order.**

Parts List:	Price:*
Plastic seat	\$20.00
with strap & buckle	
Cloth seat cover	\$17.00
Hanger tube (each)	\$ 7.00
Seat belt	\$ 5.00
Tray	\$12.00
Adjustment wire	\$ 7.00
Back brace	\$ 5.00
Hardware	\$ 5.00
Motor housing	\$22.00
Pivot housing	\$ 8.00
Large front foot (2)	\$ 5.00
Small rear foot (2)	\$ 5.00
Front base tube	\$ 7.00
Rear base tube	\$ 7.00
Leg (each)	\$ 7.00

* Prices subject to change without notice.

IF YOU NEED HELP

If you have any questions, please call toll-free:

1-800-345-4109

Return the form below with payment to:
GRACO CHILDREN'S PRODUCTS INC.
CUSTOMER SERVICE DEPARTMENT
P.O. BOX 100, MAIN STREET
ELVERSON, PA 19520

Model Number

(Must be filled in)

SHIP TO:

Name

Plastic seat
with strap & buckle

Address

Cloth seat cover

Hanger tube

City, State, Zip

Seat belt

Tray

()

Adjustment wire

Telephone

Back brace

Hardware

Motor housing

Check enclosed

Pivot housing

(payable to Graco Children's Products Inc.)

Large front foot (2)

Small rear foot (2)

Front base tube

Charge to credit card:

Rear base tube

Visa

Leg

MasterCard

Discover

Total: _____ Account #: _____

6% sales tax

(PA only): _____ Expiration date: _____

Total amount

Signature: _____

due: _____