

## Highchair

Owner's Manual • Please save for future use.

## Chaise haute

Manuel d'utilisateur  
Veuillez garder pour usage ultérieur.

## Silla alta

Manual del propietario  
Por favor, conservélo para utilizarlo en el futuro.

**3645, 3650, 3655 & 3656**

# GRACO®

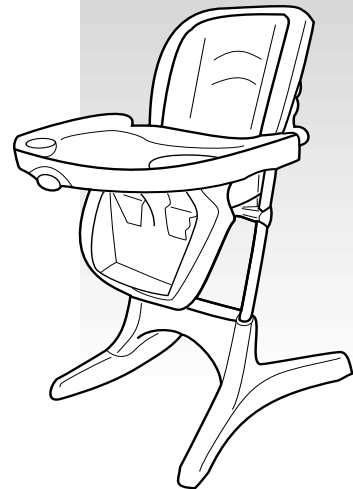

Model • Modèle • Modelo: \_\_\_\_\_ Serial No. • No. de Série • N° de Serie: \_\_\_\_\_

Dear Customer,

Please fill in the model and serial numbers above from the label on the back of the footrest of your new highchair.

### Thank you for purchasing this Graco® highchair!

Graco is the recognized leader in the design and manufacture of quality baby products. We believe your new Graco highchair is a wise choice, promising many hours of enjoyment for your baby.

Before using your highchair, please take a few minutes to read this Owner's Manual. The short time you spend reading these instructions will help you use your highchair properly.

Cher Client,

Veuillez inscrire ci-haut les numéros de modèle et de série que vous trouverez sur l'étiquette à l'endos du repose-pied de votre nouvelle chaise haute.

### Merci de votre achat d'une chaise haute Graco®!

Graco est le chef de file dans la conception et la fabrication de produits de qualité pour bébé. Nous croyons que la chaise haute Graco est un choix judicieux, garantissant plusieurs heures de plaisir pour votre bébé.

Avant d'utiliser la chaise haute, prenez quelques minutes pour lire le manuel de l'utilisateur. Ce court instant que vous prendrez à lire les instructions vous aidera à utiliser correctement la chaise haute.

Estimado cliente,

Complete los números de modelo y de serie arriba indicados, de la etiqueta en la parte posterior del apoya pies de su nueva silla alta.

### Gracias por comprar esta silla alta Graco®!

Graco es el líder reconocido en el diseño y fabricación de productos infantiles de calidad. Creemos que su silla alta Graco es una compra acertada y ofrecerá a su bebé muchas horas de placer.

Antes de usar su silla alta, dedique unos minutos a leer este manual del propietario. El poco tiempo que emplee en leer estas instrucciones le ayudará a utilizar su silla alta de manera correcta.

## **⚠️ WARNING**

Failure to follow these warnings and the assembly instructions could result in serious injury or death.

- **NEVER LEAVE CHILD UNATTENDED.** Always keep your child in view.
- **PREVENT SERIOUS INJURY OR DEATH FROM FALLS OR SLIDING OUT.** Always use seat belt. Secure your child at all times with the restraint system provided, in either the reclining or upright position. The tray is not designed to hold your child in the highchair. It is recommended that the highchair be used in the upright position only by children capable of sitting upright unassisted.
- **STRANGULATION HAZARD:** Do not place highchair in any location where there are cords, such as window blind cords, drapes, phone cords, etc.
- **THIS HIGHCHAIR IS DESIGNED TO BE USED BY A CHILD UP TO 3 YEARS OF AGE.** Maximum weight 37 pounds (16.8 kg).
- **FOLLOW ASSEMBLY INSTRUCTIONS CAREFULLY.** If you experience any difficulties, please contact the Customer Service Department.
- **DO NOT FORCE TRAY** against child. Use only the five adjustment positions. Be sure both adjustment fingers are engaged in armrest slots.
- **DO NOT ADJUST** the height or recline of the highchair with your child in it.
- **DO NOT USE TRAY** when seat is in a recline position.
- **DISCONTINUE USING YOUR HIGHCHAIR** should it become damaged or broken.

## **⚠️ MISE EN GARDE**

Manquer de suivre ces avertissements et les instructions d'assemblage peut entraîner de sérieuses blessures ou un décès.

- **NE JAMAIS LAISSER L'ENFANT SANS SUPERVISION.** Gardez toujours l'enfant à vue.
- **PRÉVEZ LES BLESSURES SÉRIEUSES OU LA MORT EN TOMBANT OU EN GLISSANT HORS DE LA CHAISE HAUTE.** Toujours attacher votre enfant avec la ceinture de retenue. Vous devez toujours attacher votre enfant avec le système de retenue fourni, que ce soit en position inclinée ou assise. Le plateau n'est pas conçu pour maintenir votre enfant dans la chaise haute. Il est recommandé que la chaise haute soit utilisée dans la position assise seulement par les enfants capables de s'asseoir sans aide.
- **DANGER D'ÉTRANGLEMENT:** ne pas installer la chaise haute à un endroit où il y a des cordons, tels les stores, les rideaux, ou téléphones, etc.
- **LA CHAISE HAUTE EST UTILISÉ PAR UN ENFANT ÂGÉ JUSQU'À 3 ANS.** Poids maximum de 37 livres (16,8 kg).
- **SUIVRE LES INSTRUCTIONS D'ASSEMBLAGE SOIGNEUSEMENT.** Si vous rencontrez des difficultés, contactez le département du service à la clientèle.
- **NE PAS FORCER LE PATEAU CONTRE L'ENFANT.** Employez seulement les cinq positions d'ajustement. Assurez-vous que toutes les tiges d'ajustement sont dans les fentes de l'accoudoir.
- **NE PAS REGLÉR** la hauteur ou l'inclinaison de la chaise haute lorsque votre enfant est dans la chaise haute.
- **N'UTILISEZ PAS LE PATEAU** lorsque le siège est en position inclinée.
- **CESSEZ L'UTILISATION DE VOTRE CHAISE HAUTE** si elle est endommagée ou cassée.

## **⚠️ ADVERTENCIA**

Si no obedecen estas advertencias y se siguen las instrucciones de montaje podría resultar en lesiones graves o la muerte.

- **NUNCA DEJE A SU NIÑO DESATENDIDO.** Siempre tenga su niño a la vista.
- **EVITE SERIAS LESIONES CAUSADAS POR CAÍDAS O DESPLAZAMIENTOS.** Use siempre el cinturón de seguridad. Asegure a su niño en todo momento con el sistema de seguridad provisto, en la posición reclinada o vertical. La bandeja no ha sido diseñada para soportar a su niño en la silla alta. Se recomienda que solamente niños capaz de sentarse en posición vertical sin ayuda usen la silla alta en la posición vertical.
- **PELIGRO DE ESTRANGULACIÓN:** No coloque la silla alta en cualquier lugar donde haya cordones, tales como cordones de persianas, cortinas, teléfonos, etc.
- **ESTA SILLA ALTA ESTÁ DISEÑADA SER USADA POR UN NIÑO DE 3 AÑOS DE EDAD COMO MAXIMO.** Con un peso máximo de 37 libras (16,8 kg).
- **SIGA LAS INSTRUCCIONES DE ENSAMBLAJE CUIDADOSAMENTE.** Si experimenta alguna dificultad, por favor, contacte al Departamento de Servicio al Cliente.
- **NO FUERCE LA BANDEJA CONTRA EL NIÑO.** Use solamente las cinco posiciones de ajuste. Asegúrese de que ambos dedos de ajuste están trabados en las ranuras de los apoyabrazos.
- **NO AJUSTE** la altura o inclinación de la silla alta con su niño sentado en ella.
- **NO USE LA BANDEJA** cuando la silla está en la posición reclinada.
- **DEJE DE USAR SU SILLA ALTA** si ésta se daña o rompe.



## Assembly

This exploded view is provided as a way to help you see the overall picture as you are assembling your product. It is not meant to replace the step-by-step instructions.

This view shows most parts associated with this product. Your product may include fewer or more parts, depending on the model.

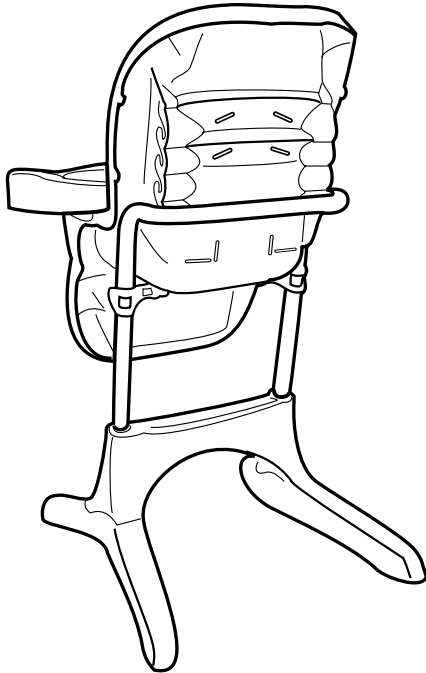

## Assemblage

Cette illustration agrandie est fournie pour vous aider à voir l'image totale lors de l'assemblage de votre produit. Cette illustration ne doit pas remplacer les instructions étape par étape.

Cette illustration démontre la plupart des pièces associées à ce produit. Votre produit peut inclure plus ou moins de pièces, selon le modèle.

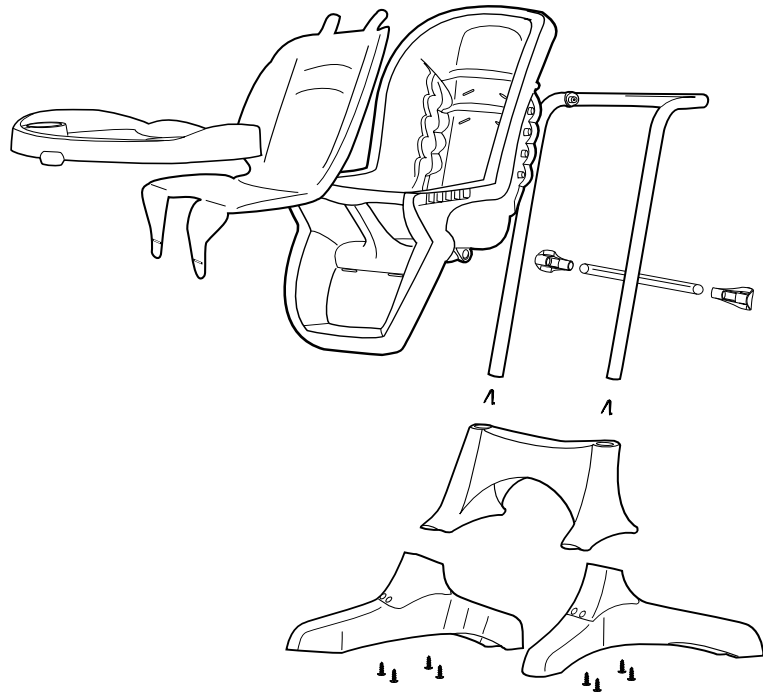

## Montaje

Se proporciona este plano detallada para darle una perspectiva global del montaje de su producto. No está destinado a remplazar las instrucciones paso por paso.

Este plano muestra la mayoría de las piezas asociadas con este producto. Su producto puede incluir más o menos piezas, según el modelo.

### Base Assembly

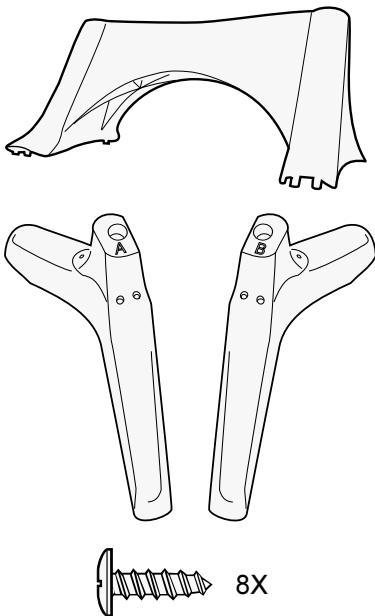

### Assemblage du base

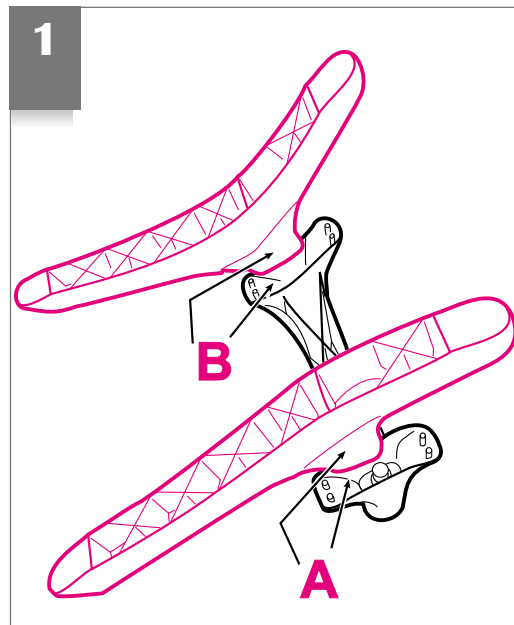

### Montaje de la base

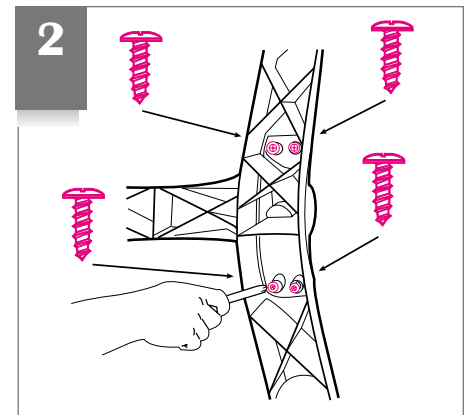

Check that all screws are tight.

Vérifiez que toutes les vis sont serrées.

Verifique que todos los tornillos estén ajustados.

**Attaching Casters  
(certain models)**

**Pour attacher les roulettes  
(certains modèles)**

**Conexión de las ruedas  
(ciertos modelos)**

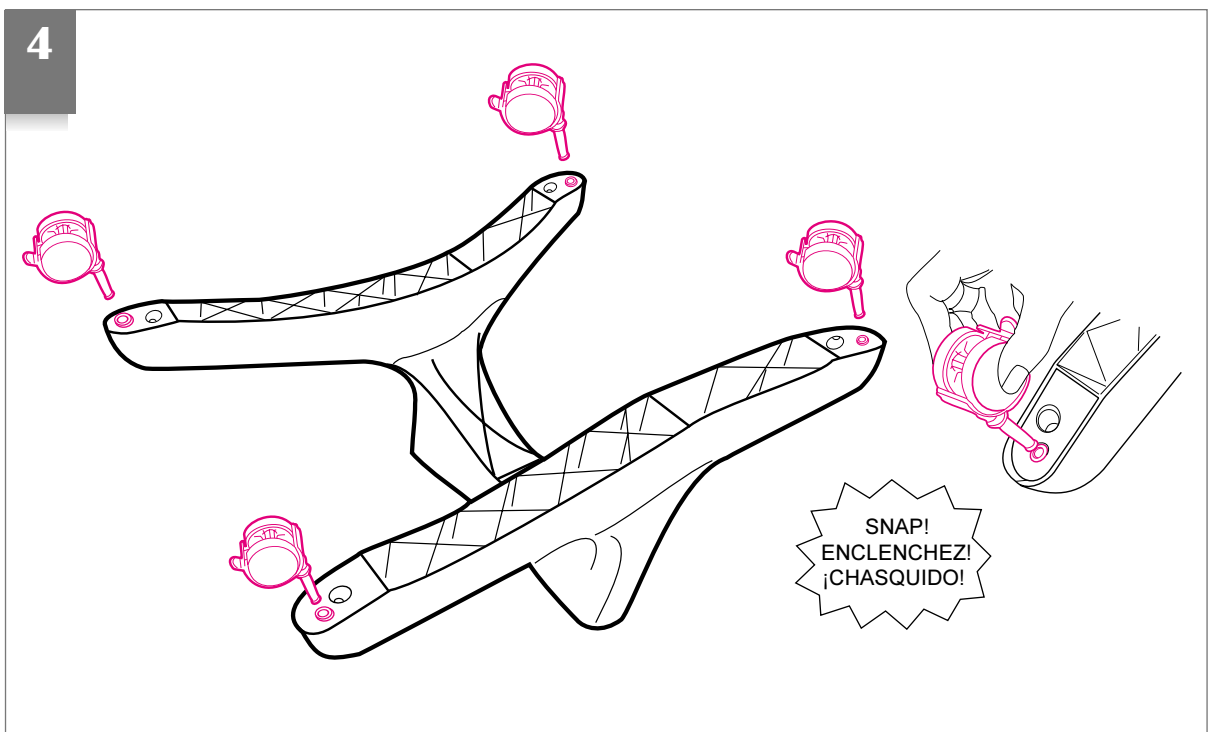
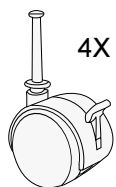
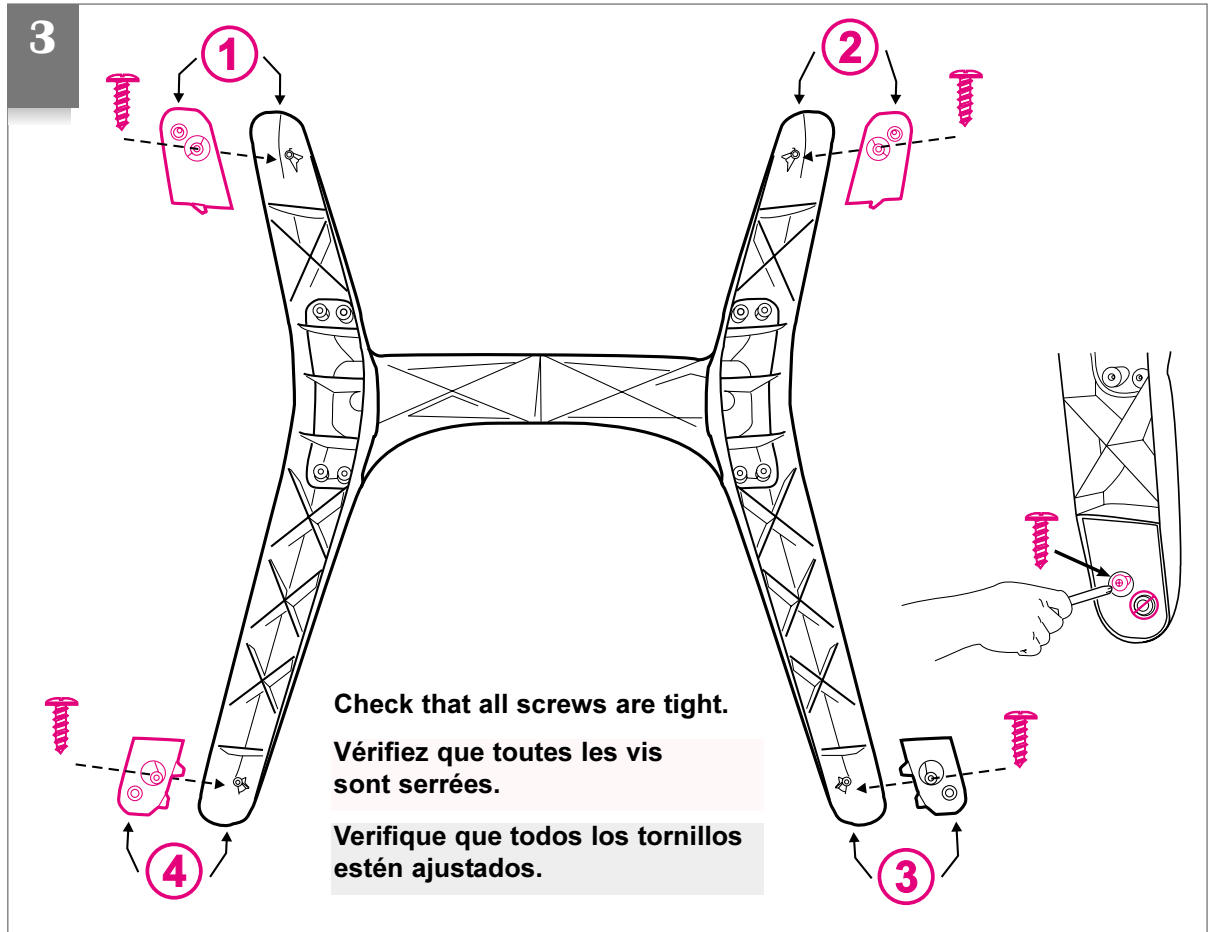
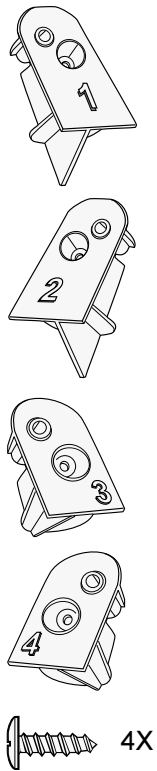

**Seat Assembly**

**Assemblage du siège**

**Montaje de la silla**

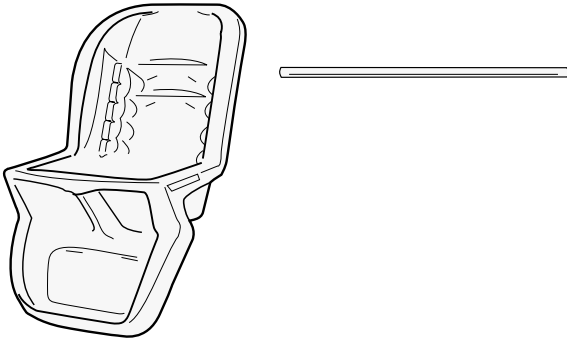

**5**

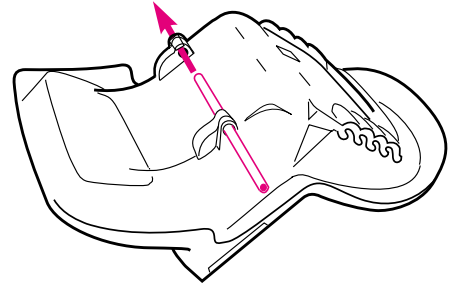

**Seat Assembly:  
Reclining Models**

**Assemblage du siège:  
modèles inclinables**

**Montaje de la silla:  
modelos reclinables**

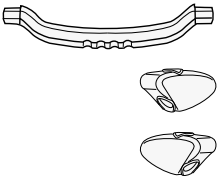

**6**

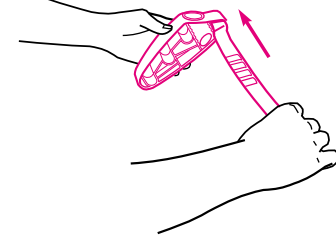

**7**

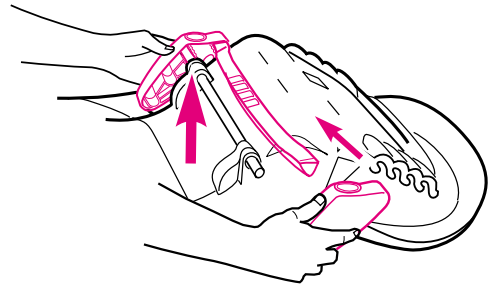

**8**

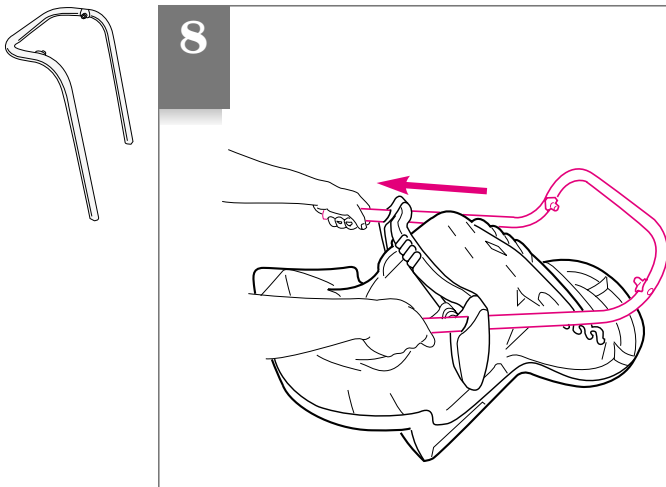

**9**

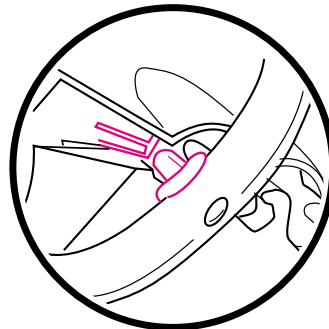
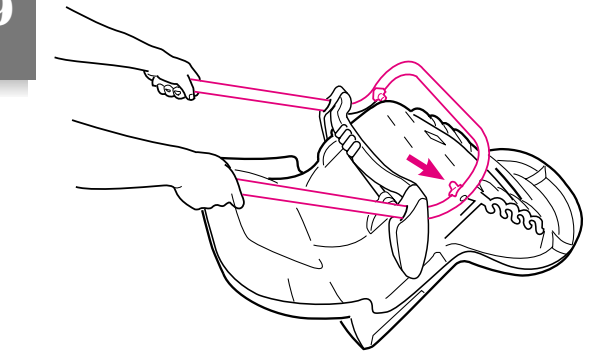

**SNAP!  
ENCLENCHEZ!  
¡CHASQUIDO!**



**Seat Assembly:  
Non-Reclining Models**

**Assemblage du siège:  
modèles non-inclinables**

**Montaje de la silla:  
modelos no reclinables**



**10**

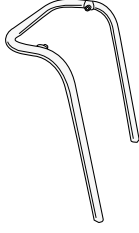
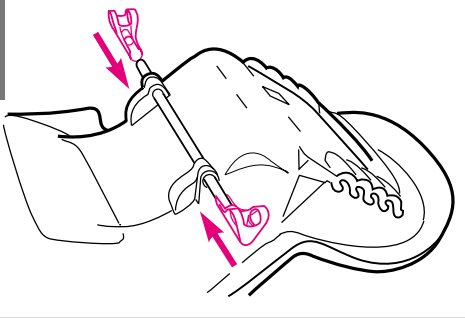

**11**

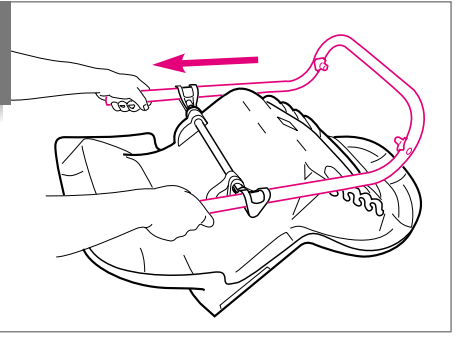

**12**

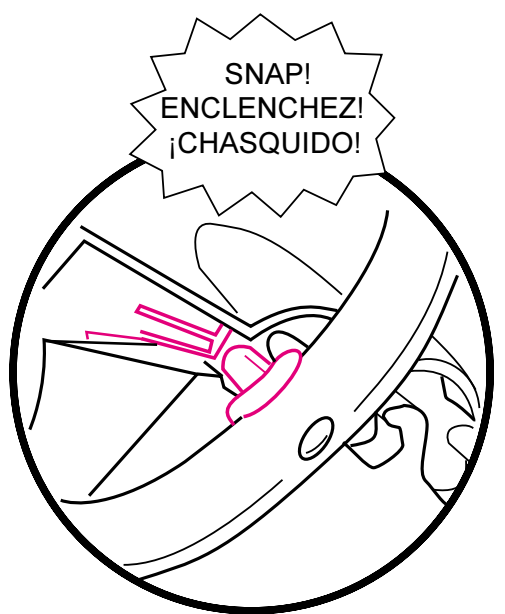
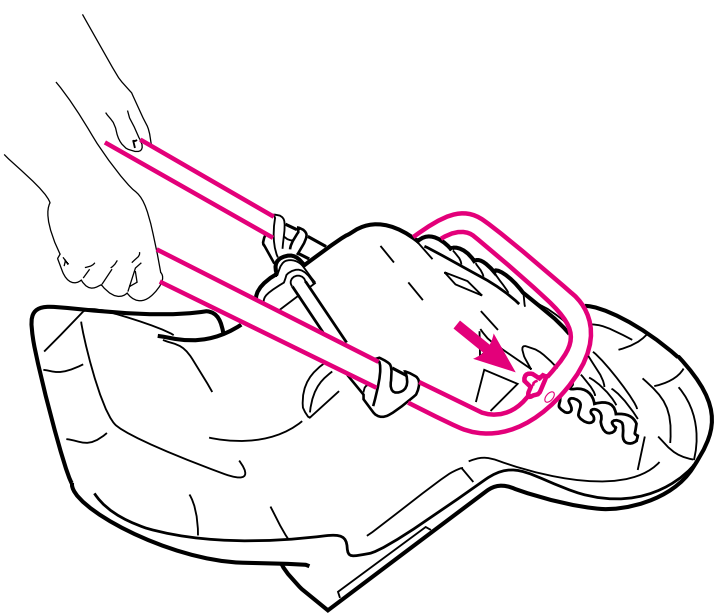

**Attaching Seat to Base**

**Fixer le siège à la base**

**Conexión de la silla  
a la base**



**13**

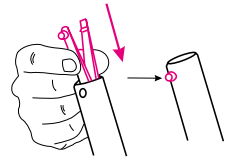
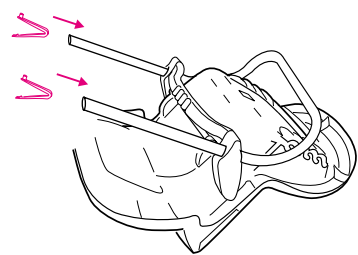

**14**

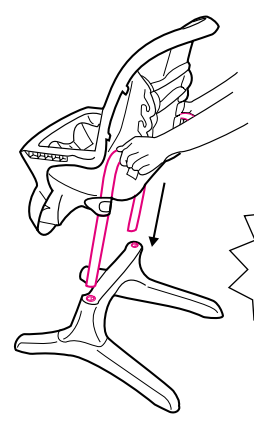

**Attaching Seat Pad:  
Waist Belt Models**

**Fixer le coussin du siège:  
Modèles avec ceinture  
à la taille**

**Conexión de la almohadilla  
del asiento: modelos con  
cinturón en la cintura**

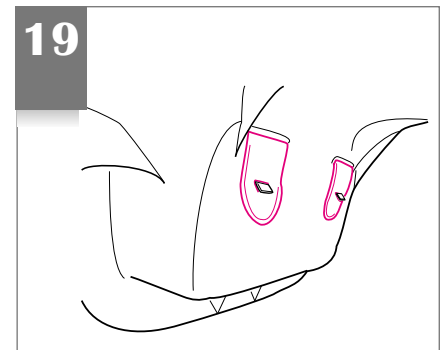
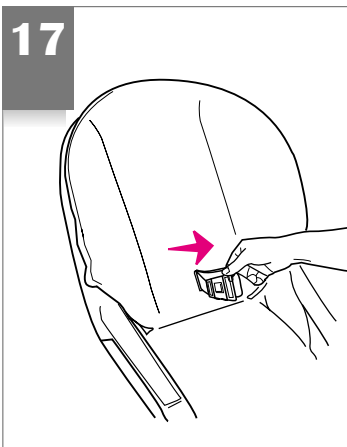
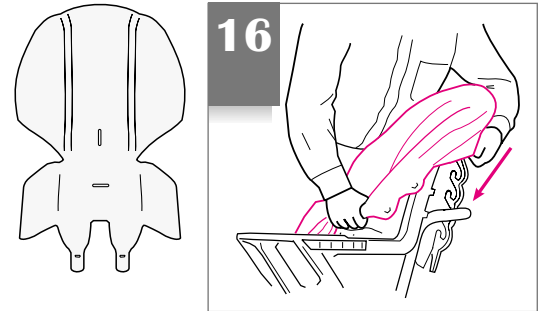
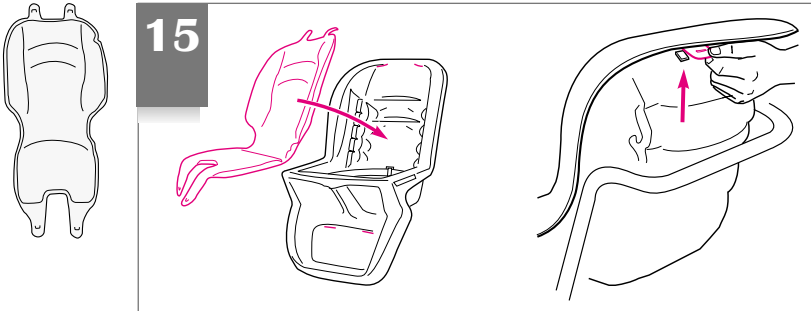

**Attaching Seat Pad:  
Harness Models**

**Fixer le coussin du siège:  
modèles avec harnais**

**Conexión del asiento a la  
silla: modelo con arnés**

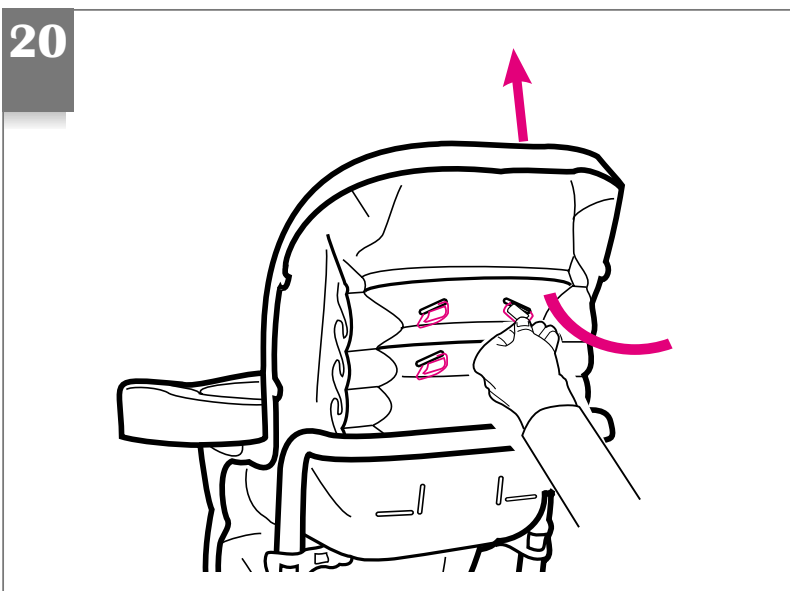

Remove shoulder straps before attaching seat pad.

Enlevez les courroies des épaules avant de fixer le coussin du siège.

Saque las correas del hombro antes de colocar la almohadilla del asiento.



### Attaching Wrap-Around Vinyl Pad

### Fixer le coussin de vinyle enveloppant

### Conexión de la almohadilla de vinilo al borde

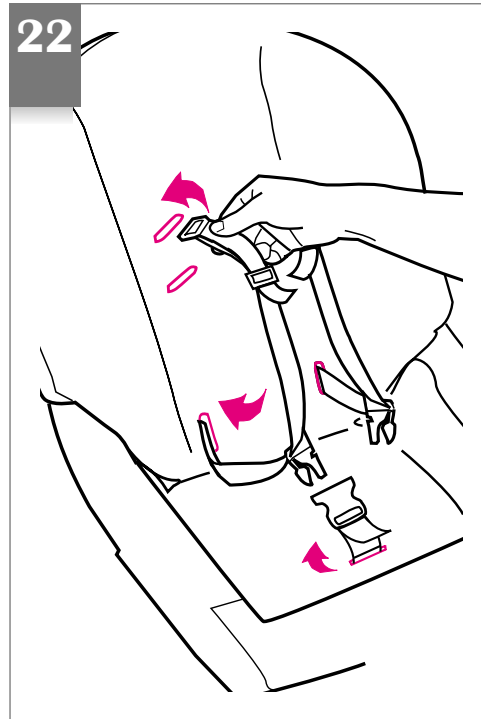
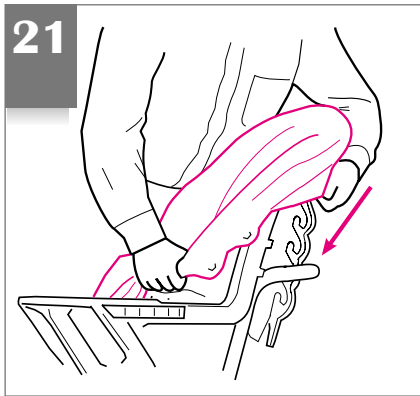
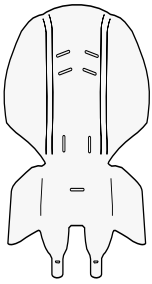

Choose the shoulder hole level that is at or slightly above your child's shoulders. Avoid twisting straps.

Choisissez le niveau qui est au niveau ou légèrement au-dessus des épaules de votre enfant. Évitez de tordre les courroies.

Elija el nivel del agujero del hombro que esté al mismo nivel o apenas encima de los hombros de su niño. Evite doblar las cintas.

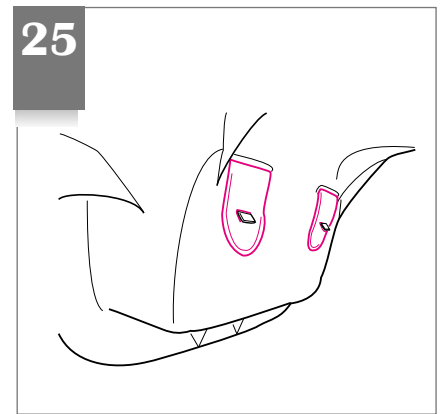
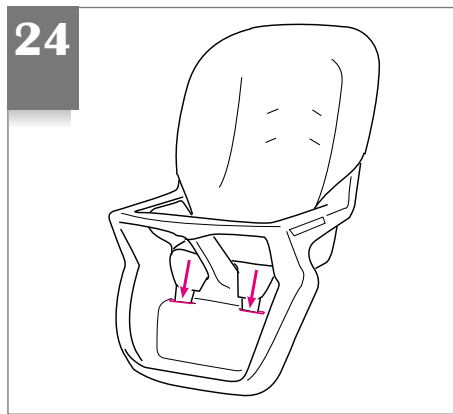
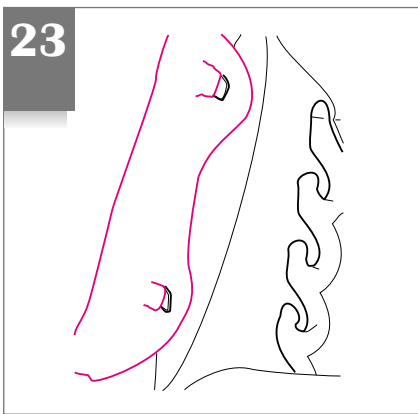

### Attaching Vinyl and Cloth Pads

### Fixer les coussins en vinyle et en tissu

### Conexión de las almohadillas de vinilo y de tela

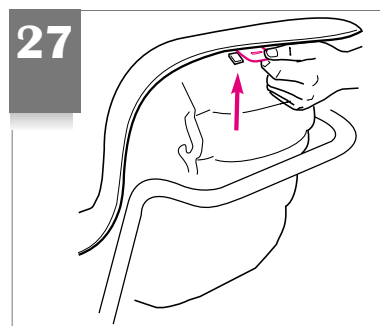
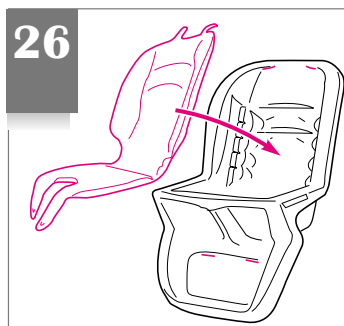
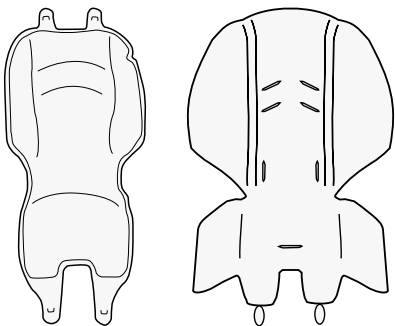

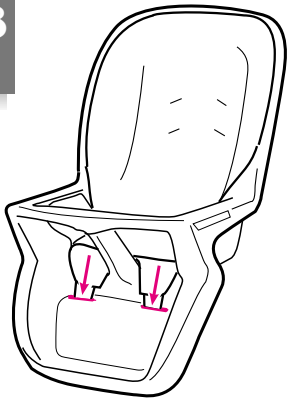
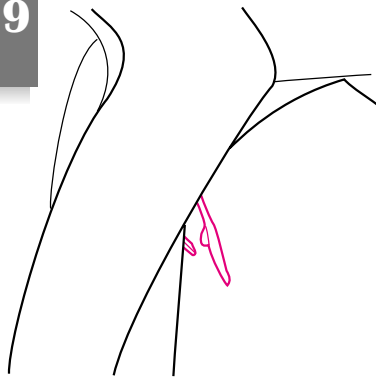
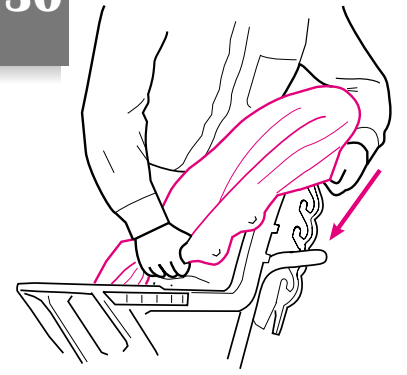
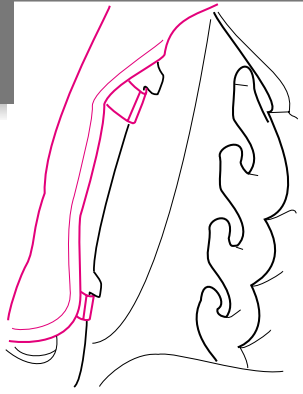
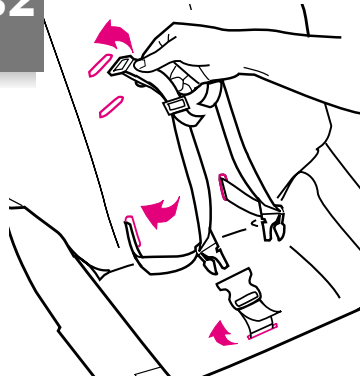
**28****29****30****31****32**

Choose the shoulder hole level that is at or slightly above your child's shoulders. Avoid twisting straps.

Choisissez le niveau qui est au niveau ou légèrement au-dessus des épaules de votre enfant. Évitez de tordre les courroies.

Elija el nivel del agujero del hombro que esté al mismo nivel o apenas encima de los hombros de su niño. Evite doblar las cintas.

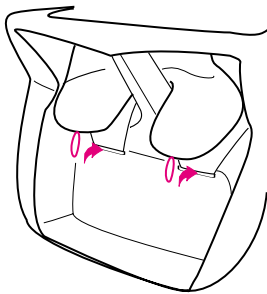
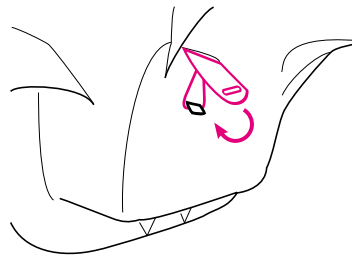
**33****34**

### To Use Highchair

### Utiliser la chaise haute

### Para usar la silla alta

#### To Secure Child: Waist Belt Models

#### Pour attacher l'enfant: modèles avec ceinture à la taille

#### Para asegurar el niño: modelos con el cinturón en la cintura

To secure  
Pour attacher  
Para asegurarlo

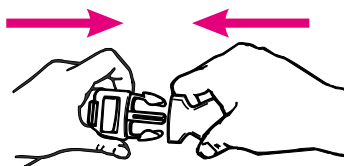
**35**

To release  
Pour dégager  
Para liberarlo

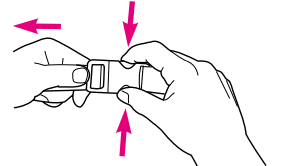
**36**

## To Secure Child: Harness Models

37

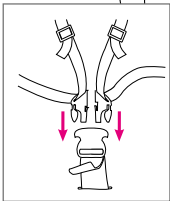

To secure

Pour attacher

Para asegurarlo

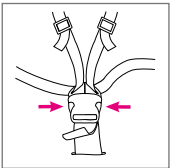

To release

Pour dégager

Para liberarlo

40

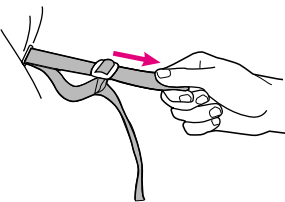

## To Use Tray

41

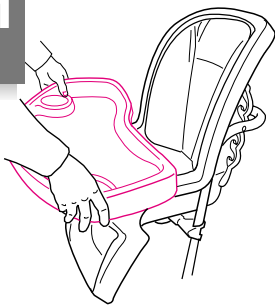

42

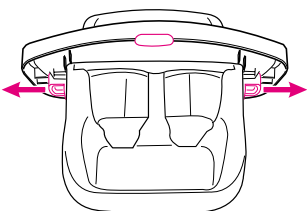

## Pour attacher l'enfant: Modèles avec harnais

38

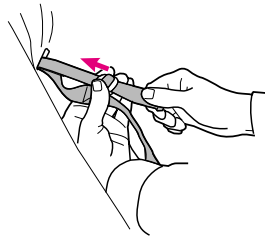

To tighten shoulder straps, hold free end of strap and slide adjuster away from the free end.

Pour ajuster les courroies des épaules, tenez l'extrémité libre de la courroie et éloignez la boucle de l'extrémité libre.

Para ajustar las cintas del hombro, agarre el extremo libre de la cinta y deslice el ajuste lejos del extremo libre.

## Para asegurar el niño: modelos con arnés

39

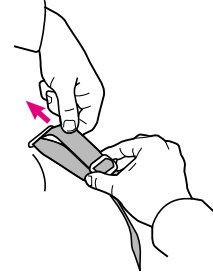

To loosen shoulder straps, hold adjuster and pull strap back through the adjuster.

Pour desserrer les courroies des épaules, tenez la boucle et tirez sur la courroie à travers la boucle.

Para aflojar las cintas del hombro, agarre el ajuste y tire la cinta hacia atrás a través del ajuste.

Tug on the free end until shoulder straps are tight. **Check behind and in front of seat to see that the straps are tight.**

Coup sur l'extrémité libre jusqu'à temps que les courroies des épaules sont tendus. **Verifiez par en arrière et en avant du siège que les courroies sont tendues.**

Tire de los extremos libres hasta que las cintas del hombro estén tensas. **Verifique adelante y atrás de la silla para determinar si las cintas están tensas.**

## Utiliser le plateau

## Para usar la bandeja

Pull out side handles under the tray. Put tray in one of the five positions, and release handles. **Check that tray is secure by pulling forward.**

Tirez sur les poignées latérales sous le plateau. Placez le plateau dans une des cinq positions de réglage et libérez les poignées latérales. **Assurez-vous que le plateau est bien fixé en tirant vers le haut.**

Tirar de las manijas laterales ubicadas debajo de la bandeja. Colocar la bandeja en una de las cinco posiciones de ajuste y soltar las manijas. **Verifique que la bandeja esté bien asegurada tirando hacia delante.**

Use either the side handles or the front button to adjust the position of the tray.

Utilisez les poignées latérales ou le bouton devant pour régler la position du plateau.

Para ajustar la posición de la bandeja, utilice las manijas laterales o el botón delantero.

## To Adjust Height

## Pour régler la hauteur

## Para ajustar la altura

43

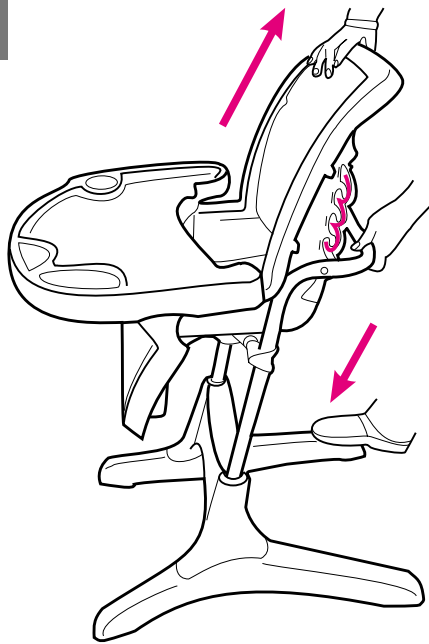

Keep fingers away from height-adjustment track. While holding the highchair down, pull up firmly on seat back to release pegs into track. Raise or lower seat to desired height. **Check that both sides of chair are snapped into the desired height-adjustment notch.**

Gardez les doigts éloignés du rail de réglage de la hauteur. En maintenant la chaise haute, tirez fermement sur le dossier du siège pour dégager les fiches dans le rail. Remontez ou abaissez le siège à la hauteur désirée. **Vérifiez que les deux côtés de la chaise sont enclenchés dans l'encoche de réglage de la hauteur désirée.**

Mantenga los dedos lejos del riel de ajuste de la altura. Mientras mantiene a la silla alta abajo, tire firmemente del respaldo de la silla para liberar las clavijas de los rieles. Levante o baje la silla hasta lograr la altura deseada. **Verifique que ambos costados de la silla están trabados en la ranura de ajuste de la altura deseada.**

## To Adjust Recline (certain models)

## Pour régler l'inclinaison (certains modèles)

## Para ajustar la posición reclinable (ciertos modelos)

44

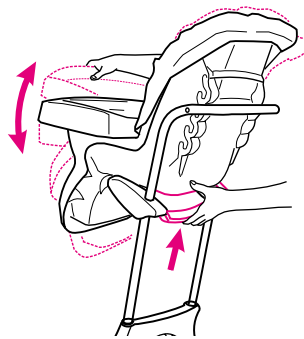

Three recline positions: Pull up on recline bar to release. Pull or push seat to desired position. Push down on recline bar to lock. **Check that both sides of the chair are snapped into the recline notches.**

Trois positions d'inclinaison: Tirez sur la barre d'inclinaison pour dégager. Tirez ou poussez le siège à la position désirée. Abaissez la barre d'inclinaison pour verrouiller. **Vérifiez que les deux côtés de la chaise sont enclenchés dans les encoches d'inclinaison.**

Tres posiciones reclinables: Tire hacia arriba para liberar la barra de reclinación. Tire o empuje el asiento hasta lograr la posición deseada. Empuje la barra de reclinación hacia abajo para que se trabé. **Verifique que ambos lados de la silla están trabados en las ranuras de reclinación.**

## Care and Maintenance

**FROM TIME TO TIME CHECK YOUR HIGHCHAIR** for loose screws, worn parts or torn material. Replace or repair the parts as needed. Use only Graco replacement parts.

**TO CLEAN HIGHCHAIR FRAME,** use only household soap or detergent and warm water. **NO BLEACH.**

## Soins et entretien

**INSPECTEZ VOTRE CHAISE HAUTE PÉRIODIQUEMENT** pour des vis desserrées, pièces usées, tissu déchiré ou écoussé. Remplacez ou réparez au besoin. Utilisez seulement les pièces de remplacement Graco.

**POUR NETTOYER L'ARMATURE DE LA CHAISE HAUTE,** utilisez seulement du savon de ménage ou du détergent avec de l'eau tiède. **PAS D'EAU DE JAVEL.**

## Cuidado y mantenimiento

**DE VEZ EN CUANDO INSPECCIONE LA SILLA ALTA** para determinar si hay tornillos sueltos, partes gastadas o materiales rotos. Cambie o repare las piezas según sea necesario. Use solamente repuestos Graco.

**PARA LIMPIAR EL BASTIDOR DE SU SILLA ALTA** utilice únicamente jabón o detergente doméstico y agua tibia. **NO UTILICE CLORO.**

## Replacement Parts (USA)

Complete the form below. Your high chair model number **MUST** be included on the form to ensure proper replacement parts. **Your model number can be found on the back of the footrest of the highchair. Payment must accompany your order.**

Return the form with payment to:  
**GRACO Children's Products Inc.**  
**Customer Service Department**  
**P.O. BOX 100, Main Street**  
**Elverson, PA 19520**



Questions? Telephone us at: • ¿Preguntas? Llámenos al:

**1-800-345-4109**

## Piezas de Repuesto (EE.UU)

Complete el formulario a continuación. El número de modelo de su silla alta **DEBE** de incluirse en este formulario para asegurar las piezas de repuesto apropiadas. **Su número de modelo se puede encontrar en la parte posterior del apoya pies de su nueva silla alta. El pago en dólares estadounidenses debe incluirse con el pedido.**

Devuélvase con pago a:  
**GRACO Children's Products Inc.**  
**Customer Service Department**  
**P.O. BOX 100, Main Street**  
**Elverson, PA 19520**

## Replacement Parts (Canada)



To purchase parts in Canada, contact Elfe at  
**1-800-667-8184**  
 (Montreal: 514-344-3533  
 Fax: 514-344-9296).

## Des pièces de remplacement (au Canada)



Pour commander les pièces au Canada, communiquez avec Elfe au  
**1-800-667-8184**  
 (Montréal: 514-344-3533  
 Fax: 514-344-9296).

• Circle the part you need.

• Marque con un círculo el repuesto que necesita.

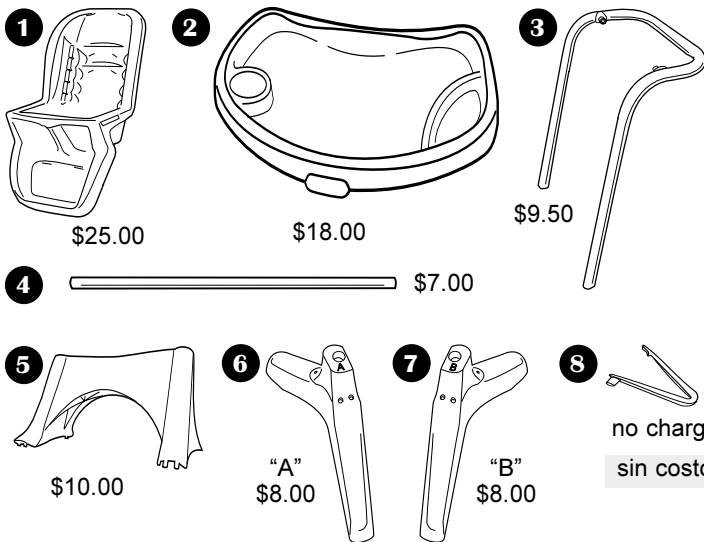

Certain models • Certains modèles • Ciertos modelos

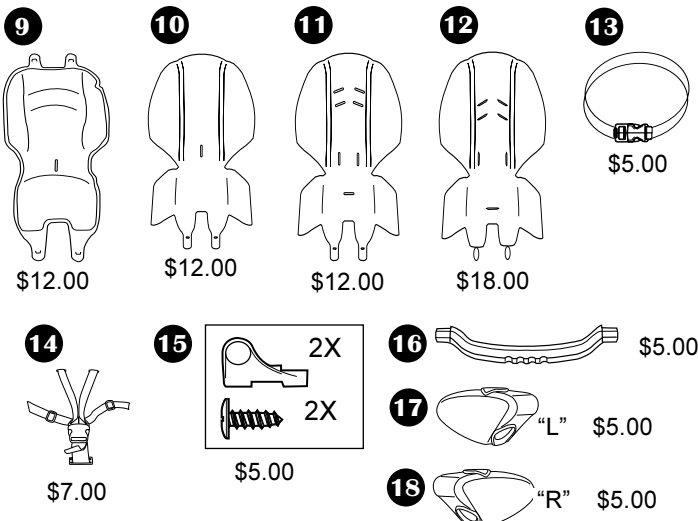

**Must be filled in:  
 Debe completarse:**

Model No.  
 N° de modelo

Serial No.  
 N° de serie

Total • Total:

Shipping & handling\*:  
 Gastos de envío\*\*: \$5.00

Sales tax\*\*:  
 Impuestos\*\*:

Total due:

Total a pagar:

\*\$15.00 outside the continental U.S.  
 \*US\$ 15.00 para fuera del continente de EE.UU  
 \*\*CA 6%, IL 6.25%, IN 5%, NY 8.25%,  
 OH 5.75%, PA 6%, SC 5%

**Ship to • Enviar a:**

Name • Nombre

Address • Dirección

City, State, Zip • Ciudad, Estado, Código postal

Telephone • Teléfono

Check or money order enclosed  
 (payable to Graco Children's Products Inc.)  
 Cheque o giro adjunto  
 (a nombre de Graco Children's Products Inc.)

Charge to credit card • Cargar a la tarjeta de crédito  
 Account #: • Cuenta N°: \_\_\_\_\_

Visa Exp. date • Fecha de vencimiento: \_\_\_\_\_

Mastercard Signature • Firma: \_\_\_\_\_

Discover \_\_\_\_\_

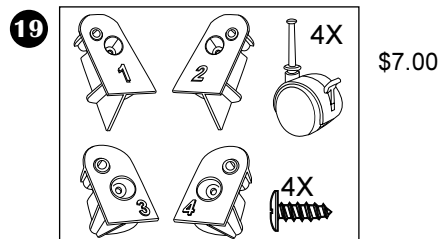







Thank you for your purchase of a Graco product. Your input regarding this product is very important to us.

**Return this card today to:**

# 1 REGISTER YOUR PRODUCT

We will keep the model number, serial number, and date of purchase of your Graco product on file.

# 2 RECEIVE FUTURE INFORMATION

By returning this card, you will help us to notify you of any issues concerning this product.

# 3 HELP US DEVELOP NEW PRODUCTS

We value your input. Your responses will help us develop new products specifically designed to meet your needs.

DETACH HERE BEFORE MAILING



## IMPORTANT! Product Registration Card IMPORTANT!

238 A

1.  Mr.    2.  Mrs.    3.  Ms.    4.  Miss

First Name: \_\_\_\_\_ Initial: \_\_\_\_\_ Last Name: \_\_\_\_\_  
 Address: (Number and Street) \_\_\_\_\_ Apt. #: \_\_\_\_\_  
 City: \_\_\_\_\_ State: \_\_\_\_\_ Zip Code: \_\_\_\_\_

2. **Phone #:**

\_\_\_\_\_

4. **Store Name:**

\_\_\_\_\_

6. **Record Model Number and Serial Number:**

(These can be found on the white label on the product)

\_\_\_\_\_

Model Number

\_\_\_\_\_

Serial Number

7. **Was this purchase a:**

1.  Gift?    2.  Self purchase?

8. **Is this your first child?**

1.  Yes    2.  No

9. **In what trimester was your purchasing decision made?**

1.  1st    2.  2nd    3.  3rd

10. **This child is:**

1.  Male    2.  Female

11. **How did you first hear about this Graco product?**

1.  Word of Mouth    5.  Store Flyer  
 2.  Salesperson    6.  Catalog  
 3.  In-Store Display    7.  Other  
 4.  Magazine Ad

12. **Check the three (3) most important reasons why you purchased this Graco product:**

1.  Received as a Gift  
 2.  Fabric Design / Appearance  
 3.  Frame Design / Style  
 4.  Graco Reputation  
 5.  Recommendation of Salesperson  
 6.  Recommendation of Friend / Family  
 7.  Value for Price  
 8.  Magazine Advertisement  
 9.  Ease of Operation  
 10.  Light Weight  
 11.  Product Features  
 12.  Sale / Promotion  
 13.  Prior Experience with Graco

13. **What other brands did you consider?**

1.  Graco was the only brand considered  
 2.  Century    6.  Fisher Price  
 3.  Combi    7.  Gerry  
 4.  Cosco    8.  Other \_\_\_\_\_  
 5.  Evenflo

14. **Have you purchased Graco products before?**

1.  Yes    2.  No

3. **I am a:**

1.  Parent    2.  Grandparent

5. **Date of Purchase:**

\_\_\_\_\_/\_\_\_\_\_/\_\_\_\_\_  
 Month    Day    Year

15. **Where do you and your family do most of your shopping?**

1.  Shopping Mall  
 2.  Discount Store  
 3.  Specialty Store

16. **Baby's date of birth: (or due date)**

\_\_\_\_\_/\_\_\_\_\_/\_\_\_\_\_  
 Month    Day    Year

17. **Date of Your birth:**

\_\_\_\_\_/\_\_\_\_\_/\_\_\_\_\_  
 Month    Day    Year

18. **For your primary residence, do you:**

1.  Own?    2.  Rent?

19. **Your marital status:**

1.  Married    2.  Single

20. **Education (Please check which category applies):**

1.  High School    3.  Completed College  
 2.  Some College    4.  Graduate School

21. **Including yourself, what is the total number of people living in your household?**

\_\_\_\_/\_\_\_\_/\_\_\_\_ (Examples: 01, 02, 03, 04...)

22. **NOT including yourself, what are the AGES of the other people living in your household?**

Age (in years)

Male: \_\_\_\_\_

Female: \_\_\_\_\_

23. **Which best describes your family income?**

1.  Under \$15,000    5.  \$50,000-\$74,999  
 2.  \$15,000-\$24,999    6.  \$75,000-\$100,000  
 3.  \$25,000-\$34,999    7.  \$100,000-\$149,999  
 4.  \$35,000-\$49,999    8.  Over \$150,000

24. **In the last 6 months have you or your spouse:**

1.  Purchased clothes through the mail?  
 2.  Purchased gifts through the mail?  
 3.  Worked in your garden?  
 4.  Traveled on vacation?  
 5.  Purchased through television shopping?  
 6.  Purchased two or more books?  
 7.  Purchased cassettes or CDs?  
 8.  Donated to wildlife / environmental causes?  
 9.  Donated to charities?

Thanks for taking time to fill out this questionnaire. Please check here [ ] if you do not wish to learn more about Graco or obtain information on new ideas from other exciting companies.

**IMPORTANT!**

PRODUCT REGISTRATION CARD

THANK YOU  
FOR CHOOSING

**GRACO®**

Please take a moment to  
complete this card today to:

- ▶ REGISTER  
YOUR  
PRODUCT
- ▶ RECEIVE  
FUTURE  
INFORMATION
- ▶ HELP US  
DEVELOP NEW  
PRODUCTS

Please send other correspondence to:

Graco Children's Products, Inc.  
Main Street  
P.O. Box 100  
Elverson, PA 19520-0100

238 A

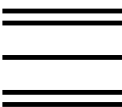

Place  
First-Class  
Stamp  
Here  
Post Office will  
not deliver  
without proper  
postage

**GRACO®**

PRODUCT REGISTRATION DEPARTMENT  
PO BOX 40  
DENVER CO 80201-0040

