

GRACO®

Highchair

OWNER'S MANUAL

Model No. _____
Serial No. _____

Dear Customer,

Please fill in the model and serial numbers above from the label on the back of the footrest of your new highchair.

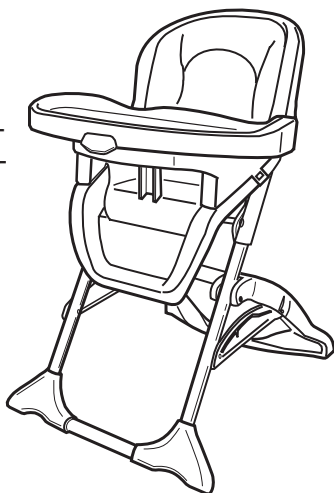

Models 3835, 3845, 3848, 3855, and 3865

Congratulations on your purchase of a Graco® highchair!

Graco is the recognized leader in the design and manufacture of quality baby products. We believe your new Graco® highchair is a wise choice, promising many hours of enjoyment for your baby.

Before using your highchair, please take a few minutes to read this Owner's Manual. The short time you spend reading these instructions will help you use your highchair properly.

Please save your Owner's Manual for future use.

Customer Satisfaction

Our goal is to make every product the best it can be! We are also committed to supporting our products after purchase. If you would like to speak to Graco about your product, please contact our **Customer Service Department at 1-800-345-4109**. Our knowledgeable staff will be ready to answer any questions you may have concerning parts, use, or maintenance. When you call, please have the **model and serial numbers** ready so your call may be processed quickly and efficiently.

⚠ WARNING

Failure to follow these warnings and instructions could result in injury or death.

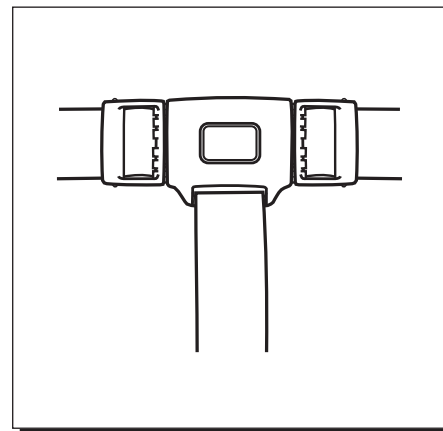

Prevent serious injury or death from falls or sliding out. Always secure child in the restraint.



Never leave child unattended. Always keep your child in view.

THIS PRODUCT REQUIRES ADULT ASSEMBLY.

FOLLOW ASSEMBLY INSTRUCTIONS CAREFULLY.

If you experience any difficulties, please contact the Customer Service Department.

THIS HIGHCHAIR IS DESIGNED TO BE USED by a child up to 3 years old. Maximum weight 37 pounds (17 kg).

DO NOT FORCE TRAY against child. Use only the five adjustment positions. Be sure all adjustment fingers are in armrest slots.

DISCONTINUE USING YOUR HIGHCHAIR should it become damaged or broken.

WARNING

Warnings and the assembly in serious injury or death.

Secure your child at all times with the restraint system provided, in either the reclining or upright position. The tray is not designed to hold your child in the highchair. It is recommended that the highchair be used in the upright position only by children capable of sitting upright unassisted.

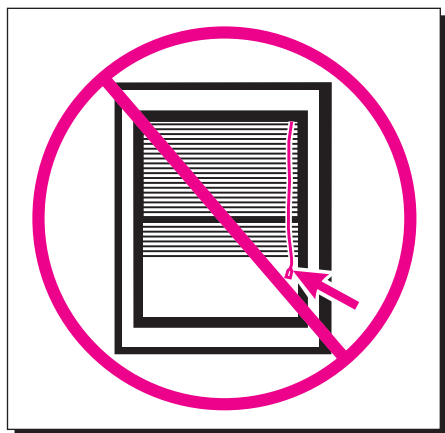

STRANGULATION HAZARD:
DO NOT place highchair in any location where there are cords, such as window blind cords, drapes, phone cords, etc.

CARE AND MAINTENANCE

FROM TIME TO TIME CHECK YOUR HIGHCHAIR for loose screws, worn parts or torn material. Replace or repair the parts as needed. Use only Graco® replacement parts.

REMOVABLE CLOTH SEAT PAD (on certain models) may be machine washed in lukewarm water on delicate cycle and drip-dried. **NO BLEACH.**

TO CLEAN HIGHCHAIR FRAME, use only household soap or detergent and warm water. **NO BLEACH.**

PARTS LIST

CHECK that you have all the parts listed below BEFORE assembling your highchair. If any parts are missing, call Customer Service at 1-800-345-4109.

Tool required: Screwdriver

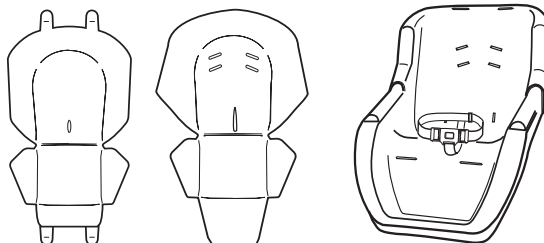

Seat pad (style depends on model)

Seat with seat belt or harness

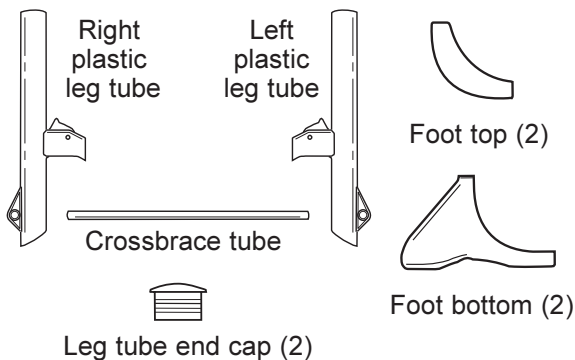

Right plastic leg tube

Left plastic leg tube

Foot top (2)

Crossbrace tube

Leg tube end cap (2)

Foot bottom (2)

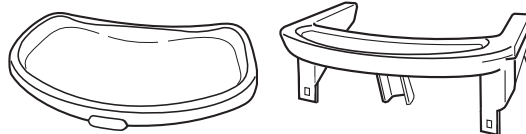

Large tray

Small tray

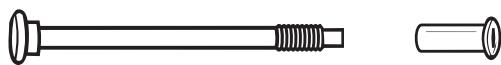

Bolt (2)

T-nut (2)



Hex wrench

Screw (2)

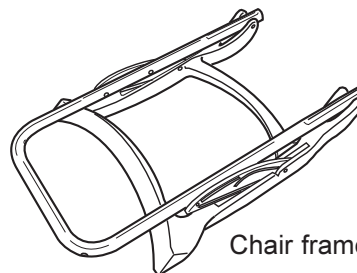

Chair frame

To Assemble Highchair

Step 1.

IMPORTANT: BEFORE attaching feet to highchair, frame **MUST** be folded exactly as in the drawing below. Lay highchair frame on floor so it looks like the drawing before attaching feet.

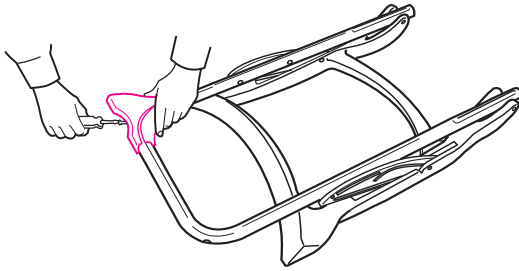

Place a foot top and foot bottom at each corner of the chair frame tube. Insert a screw into the foot bottom, through the hole in the chair frame, and into the foot top. Tighten screws securely, but **do not overtighten**.

Step 2.

Unfold the chair frame as shown. Insert one bolt and one T-nut into each leg brace and through the holes in the legs. Tighten them securely with a screwdriver and the enclosed hex wrench.

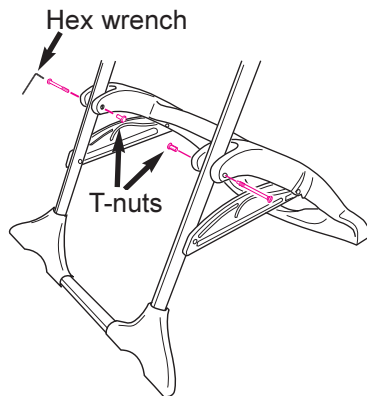

Step 3.

Snap end caps into ends of right and left plastic leg tubes.

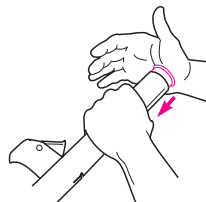

Step 4.

Turn the seat upside down as shown. Match up the "L" or "R" on the plastic leg tubes with the letters molded on the seat back. Slide the leg tubes into the "collars" on the seat back.

Slide the crossbrace tube through the slots under the seat. Then insert the ends of the crossbrace tube into the holes in the leg tubes. (This may be more easily done if the crossbrace tube is held at an angle as shown.)

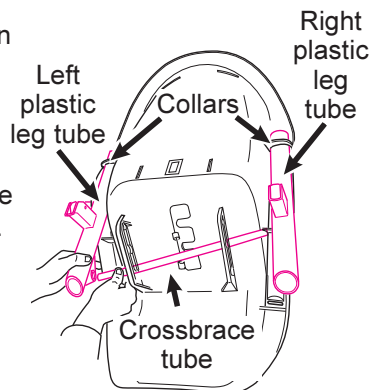

Step 5.

Set chair frame into upright position. Slide the seat assembly onto the frame. Press the red latches, located on the plastic leg tubes, to allow seat to slide onto frame.

NOTE: Lowest seat position should **NOT** rest on top of legs. Pull seat up to lowest latching position.

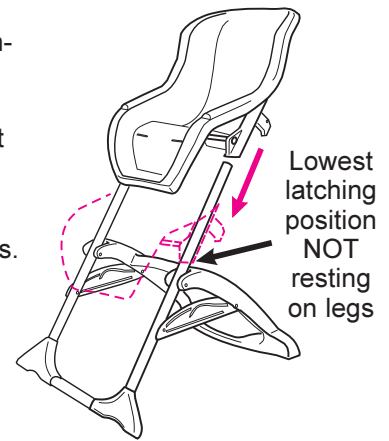

To Attach Seat Pad

Your highchair seat pad will either have 4 attachment tabs or a pocket on the back. Follow the appropriate instructions below:

SEAT PAD WITH FOUR TABS:

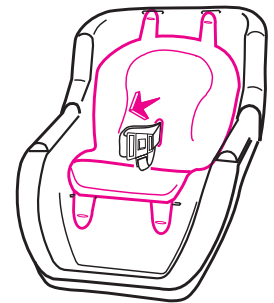
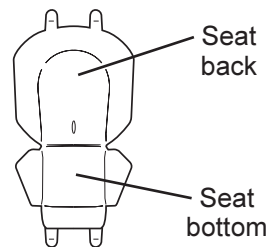

Step 1.

Place seat pad in seat. Large part of pad goes on seat back as shown. Pull the seat belt through the hole in the middle of the seat pad.

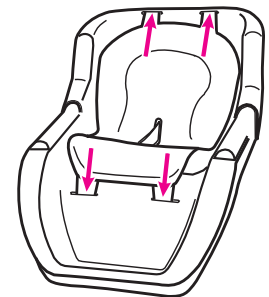

Step 2.

Push the four tabs on the seat cover into the slots at the top and bottom of the seat.

Step 3.

From the rear of the seat, pull the four tabs over the plastic anchors near them.

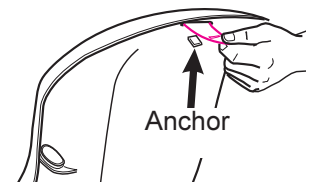

SEAT PAD WITH POCKET:

Your highchair will have **either** a seat belt or a 5-point harness. Follow the proper instructions below.

Step 1.

SEAT BELT MODELS:

Position seat pad over highchair. Pull the seat belt through the hole in the middle of the seat pad.

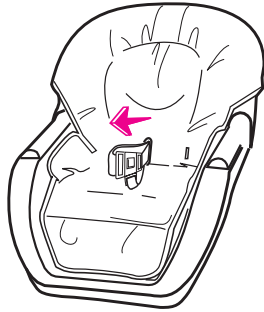

5-POINT HARNESS MODELS:

Straps must first be removed from seat before pad can be attached. Behind the seat back, locate four small plastic retainers on the shoulder straps. Push them through the slots in seat to the front. Set straps aside.

Position seat pad over highchair. Push each plastic retainer through proper hole in seat pad and back into slot it was removed from, as shown. (The strap length adjustment buckles will be near the shoulders.) Avoid twisting straps.

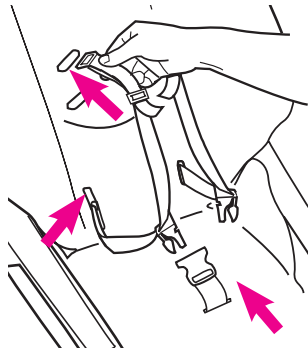

Two levels of shoulder holes are provided. Choose the level that is at or slightly above your child's shoulders.

Pull crotch strap and buckle through center opening in seat pad.

Step 2.

Attach seat pad by sliding pocket over the back of the seat as shown.

NOTE: On certain models with a cloth pad, pad is reversible. Turn pocket inside out to reverse.

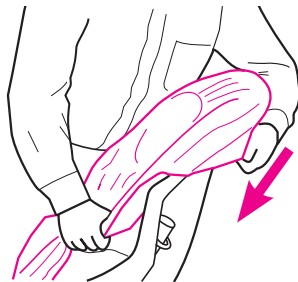

To Use Restraint

SEAT BELT MODELS:

Place crotch strap between child's legs and snap both side buckles to the center buckle. Adjust belt as needed to get a snug fit around your child.

Push in on front of buckle to release.

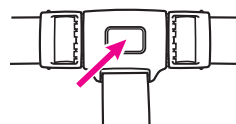
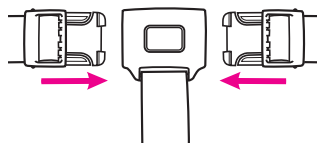

HARNESS MODELS:

Place the crotch strap between your child's legs and insert the harness buckles into the center buckle housing. Adjust shoulder straps as needed (pull adjustment buckles down to loosen harness, push them up to tighten harness) to get a snug fit around your child. Check that belt is tightly threaded through retainers behind seat.

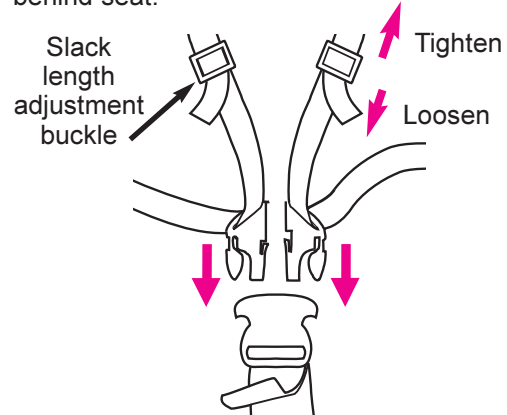

To release, squeeze buckle at right and left sides of center housing.

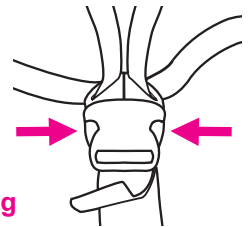

▲ WARNING Prevent serious injury or death from falls or sliding out. Always secure your child in the restraint. Do not depend on the tray alone to hold your child.

The position of the shoulder straps can be adjusted for the size of your child. Locate the small retainers behind the seat back, push them through to the front and move them to the higher or lower position as needed.

If it becomes necessary to remove the seat belt, follow these instructions:

SEAT BELT MODELS:

Step 1.

Unthread both ends of seat belt through the buckles as shown.



Step 2.

Pull one end of the seat belt through the belt retainer as shown.

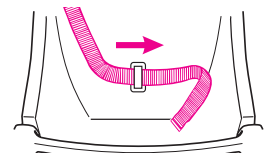

Step 3.

To rethread buckle, reverse the above steps. **CHECK** that the belt is threaded correctly by pulling on the seat belt. **The belt should not slip through the buckle.**

HARNESS MODELS:

Remove seat pad. Follow directions given under "To Attach Seat Pad" to remove harness straps from seat.

To Use Small Tray

Highchair can be used with small tray alone, or with large tray attached on top of small tray.

Insert the tabs on the small tray into the slots at the front of the armrests. Push down on the rear of the tray until both latches at the sides snap onto seat.

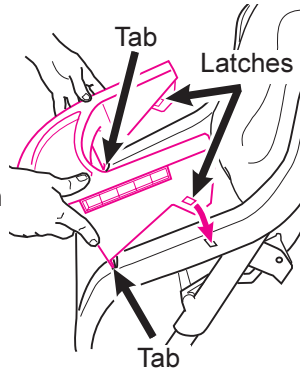

CHECK that small tray is securely attached by pulling up on the tray.

Tray may be removed from highchair by pulling out the side latches and lifting off tray.

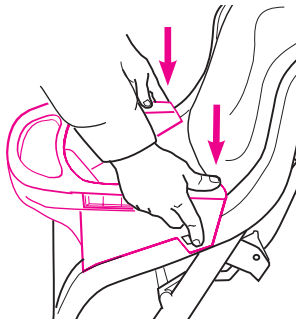

To Use Large Tray

▲WARNING Small tray must be attached securely to highchair before using the large tray.

Place the large tray on the armrests of the small tray. Pull out the side handles under the large tray. Put the tray in one of the five adjustment positions, and release the side handles.

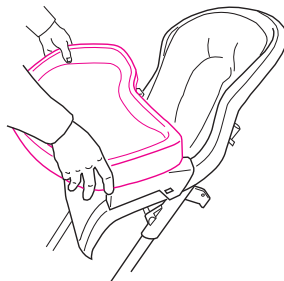

CHECK that tray is securely attached by pulling forward on the tray.

Use either the side handles or the front button to adjust the position of the large tray.

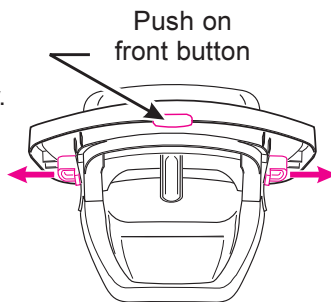

▲WARNING DO NOT force the tray against your child. Keep your child's hands and fingers away from the tray when adjusting the tray.

Tray may be removed from highchair by using the side handles.

To Adjust Height

▲WARNING DO NOT adjust the highchair with your child in it.

Place foot on base of rear legs. Lift seat slightly by the handles at rear of chair and press both red latches. Slide the seat up or down until it latches.

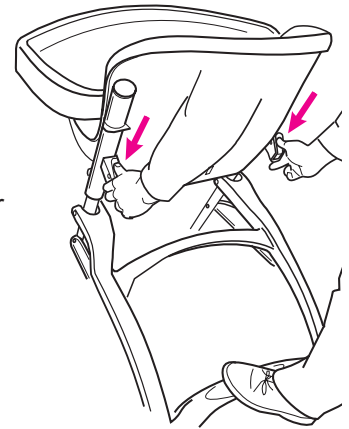

There are six possible height settings. The highchair can be used as a toddler chair by adjusting to the lowest height setting (which does NOT rest on top of legs).

CHECK that both sides of chair are latched at the same height setting.

To Adjust Recline (on certain models)

▲WARNING DO NOT adjust recline with your child in the highchair.

Flip up the red lock under the seat. Lift the seat slightly, and recline it to one of the three settings.

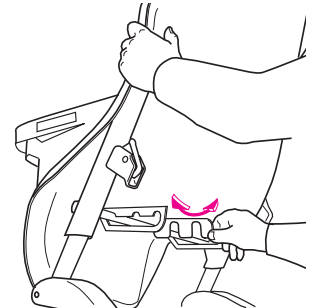

Be sure that lock is flipped back down after changing recline. It is recommended that the highchair be used in the upright position only by children capable of sitting upright unassisted.

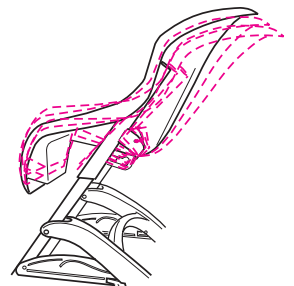

Do not use large tray when seat is in a recline position.

To Fold Highchair

Lay the highchair on the floor as shown. Press in the tabs on both leg crossbraces as shown. Then push the rear legs down to fold the highchair.

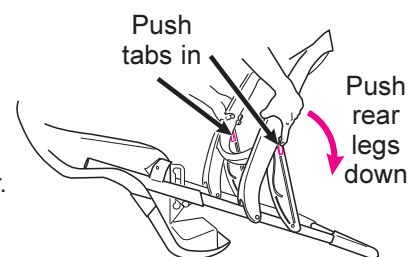

Replacement Parts

Instructions for ordering highchair parts:

Complete form below. Your highchair model number **MUST** be included on the form to ensure proper replacement parts. **Your model number can be found on a sticker on the back of the footrest. Payment must accompany your order.**

Parts List:	Price:**
Large tray	\$18.00
Small tray	\$14.00
Seat	\$22.00
Vinyl seat pad with tabs*	\$12.00
Vinyl seat pad with pocket*	\$15.00
Cloth seat pad (not reversible)* ...	\$18.00
Cloth seat pad (reversible)*	\$22.00
Plastic tube (L or R)	\$ 8.00 (each)
Crossbrace tube	\$ 7.00
Foot top	\$ 5.00 (each)
Foot bottom	\$ 5.00 (each)
Seat belt	\$ 5.00
Hardware	\$ 5.00

* Only on certain models.

** Prices subject to change without notice.

IF YOU NEED HELP

If you have any questions, please call toll-free:

1-800-345-4109

Return the form below with payment to:
GRACO CHILDREN'S PRODUCTS INC.
CUSTOMER SERVICE DEPARTMENT
P.O. BOX 100, MAIN STREET
ELVERSON, PA 19520

Model Number	SHIP TO:
_____	_____
(Must be filled in)	Name
<input type="checkbox"/> Large tray	_____
<input type="checkbox"/> Small tray	Address
<input type="checkbox"/> Seat	_____
<input type="checkbox"/> Vinyl pad with tabs	City, State, Zip
<input type="checkbox"/> Vinyl pad with pocket	_____
<input type="checkbox"/> Cloth pad (not reversible)	()
<input type="checkbox"/> Cloth pad (reversible)	Telephone
<input type="checkbox"/> Plastic tube (L or R)	_____
<input type="checkbox"/> Crossbrace tube	
<input type="checkbox"/> Foot top	<input type="checkbox"/> Check enclosed
<input type="checkbox"/> Foot bottom	(payable to Graco Children's
<input type="checkbox"/> Seat belt	Products Inc.)
<input type="checkbox"/> Hardware	<input type="checkbox"/> Charge to credit card:
	<input type="checkbox"/> Visa
	<input type="checkbox"/> MasterCard
	<input type="checkbox"/> Discover
Total: _____	
Shipping & handling: <u>\$5.00</u>	Account #: _____
6% sales tax (PA only): _____	Expiration date: _____
Total amount due: _____	Signature: _____