

Read all instructions BEFORE assembly and use of this product.

Keep instructions for future use.

We recommend that you keep these instructions with your Pack 'N Play. A storage pocket has been provided for them on the bottom panel of your unit.

GRACO®

Pack 'N Play® Bassinet

OWNER'S MANUAL

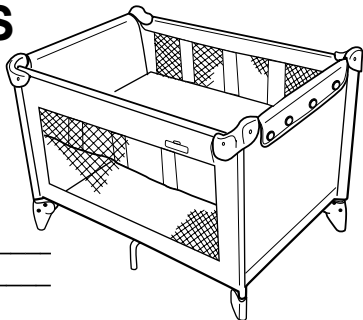

Model No. _____

Serial No. _____

Dear Customer,
Please fill in the model and serial numbers above from the label in the center of the bottom of your new Pack 'N Play Bassinet.

**Models 9045, 9046, 9346, 9640,
9643, 9716, 9726, 9741, 9743,
9745 & 9746**

Congratulations on your purchase of a Graco® Pack 'N Play® Bassinet!

Graco is the recognized leader in the design and manufacture of quality baby products. We believe your new Graco® Pack 'N Play® Bassinet is a wise choice, promising many hours of enjoyment for your baby.

Your Pack 'N Play® may be used as a playard, portable crib or bassinet.

Customer Satisfaction

Our goal is to make every product the best it can be! We are also committed to supporting our products after purchase. If you would like to speak to Graco about your product, please contact our **Customer Service Department at 1-800-345-4109** or visit our Internet website, www.gracobaby.com. Our knowledgeable staff will be ready to answer any questions you may have concerning parts, use or maintenance. When you call, please have the **model and serial numbers** ready so your call may be processed quickly and efficiently.

⚠ WARNING

Failure to follow instructions could result in injury or death.

Setting Up the Pack 'N Play

- THIS PRODUCT REQUIRES ADULT ASSEMBLY.
- Keep fingers clear of top corners during setup. Be sure Pack 'N Play is completely set up before use. Check that the four top rails are completely latched, the center of the floor is pushed down, and the mattress is flat and secured by the VELCRO® straps. Always follow the instructions in the owner's manual to set up the Pack 'N Play.
- When using the bassinet make sure VELCRO® patches underneath mattress firmly attach to bassinet mesh.
- Before each use, inspect this product for damaged hardware, loose joints, missing parts or sharp edges. Do not use Pack 'N Play if any parts are missing or broken. Call 1-800-345-4109 for replacement parts or owner's manual. Do not substitute parts.

Using the Pack 'N Play

- The Pack 'N Play can be used as a playard, bassinet or sleeping crib. When used as a playard, never leave child unattended and always keep child in view. When used as a sleeping crib or bassinet, you must still provide the supervision necessary for the continued safety of your child.
- Always keep the Pack 'N Play away from hazards in the area that may injure your child.
- Do not add padding or other objects inside the Pack 'N Play that will permit your child to climb out.
- Stop using this product when your child reaches 35 inches (890 mm) in height, weighs more than 30 pounds (14 kg), or is able to climb out.
- Do not modify Pack 'N Play or add any attachments that are not listed in the owner's manual, including an add-on bassinet.

Using the Bassinet

- Use bassinet with only one child at a time.
- The bassinet must be fully assembled and installed, including top rails, snaps and bottom pad, before using.

⚠ WARNING

Failure to follow instructions could result in injury or death.

Follow these warnings and the assembly instructions could result in serious injury or death.

- Discontinue using your bassinet if child weighs over 15 lbs. (6.8 kg), can roll over, or can push up on hands and knees.
- Never place a child under the bassinet.
- DO NOT store the bassinet in the Pack 'N Play while in use. Store rails in pocket in the bassinet.
- Never use a canopy with bassinet installed.

Avoiding Suffocation Hazards

- Unlike cribs that have rigid sides, the Pack 'N Play and the bassinet have flexible sides. As a result, the Pack 'N Play mattress is specially designed to prevent suffocation. The Pack 'N Play mattress has a solid base, a certain length and width, and is less than one inch thick in order to meet safety standards. Using a thicker or a different sized mattress may allow a child's head to get between mattress and the side of the Pack 'N Play or bassinet causing suffocation.
- To help prevent suffocation from entrapment, USE ONLY THE MATTRESS PROVIDED BY GRACO. Never use additional mattress or padding.
- Never use plastic shipping bags or other plastic film as mattress covers not sold and intended for that purpose. They can cause suffocation.
- Do not use a water mattress with the Pack 'N Play.

Avoiding Strangulation Hazards

- Strings and cords can cause strangulation. Keep strings and cords away from child.
 - Do not place the Pack 'N Play near a window where cords from blinds or drapes can strangle a child.
 - Do not hang strings on or over the Pack 'N Play.
 - Do not place items with a string around a child's neck, such as hood strings, pacifier cords, etc.
 - Do not attach strings to toys.

This product is not intended for commercial use.

Follow these warnings and the assembly instructions could result in serious injury or death.

PACK 'N PLAY INSTRUCTIONS

Setting up the Pack 'N Play® is easy, once you know how:

To Set Up Your Pack 'N Play®

Step 1.

Undo the three VELCRO® straps. Fold VELCRO® straps back onto themselves.

Set mattress aside.

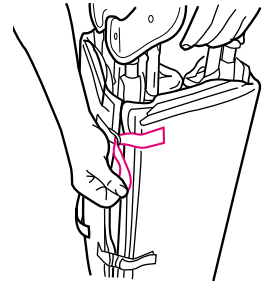

Step 2.

IMPORTANT: Leave center of floor UP until all four top rails are latched.

Grasp the bottom of two of the top rails, and pull up until you hear a "click."

Be sure top rails have become rigid.

If not, pull up again until they are rigid.

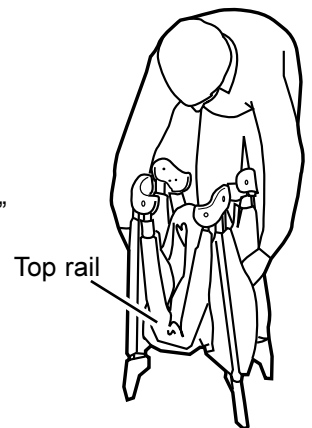

FOR SMOOTH SETUP and takedown, it's important to remember one thing: the center of the floor must be at least halfway up when locking OR unlocking rails (see picture below). Therefore:

- **When setting up, lock rails BEFORE lowering center.**
- **When taking down, raise center halfway BEFORE unlocking rails.**

Step 3.

Pull up the other two sides until they latch.

If top rails do not latch, lift the center of the floor higher. Center of floor must be at least halfway up for the latches to catch properly.

Be sure all top rails are rigid.

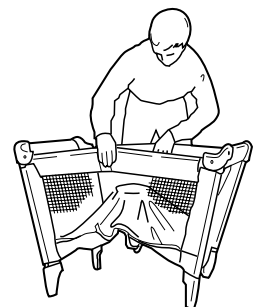

Step 4.

Hold one end of the unit up and push the center of the floor down.

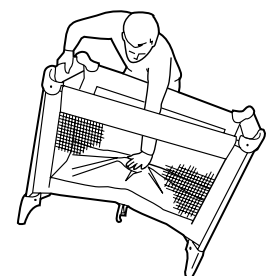

At first your Pack 'N Play **may** be like a new pair of shoes. You may need to break it in by slightly stretching the netting and fabric. If the center does not stay down, place some weight (several books) in the center of the unit and let it stand overnight.

To Use as a Playard/Portable Crib

Place mattress into your unit with padded side up.

Always use your unit with mattress installed soft side up.

Slide the two VELCRO® straps through slots in bottom of Pack 'N Play and fasten to VELCRO® on underside. This will prevent mattress from moving.

Your Pack 'N Play is ready to use.

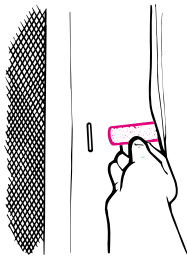
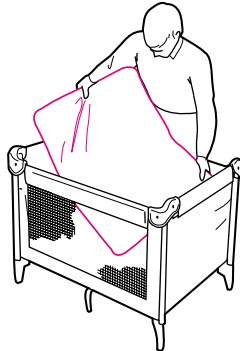

To Fold Your Pack 'N Play®

Step 1.

Lower the back flap. Apply locks on wheels or casters, if present. Release the two VELCRO® straps under the Pack 'N Play, and remove the mattress.

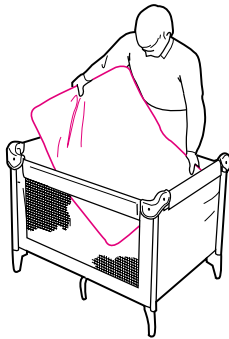

Step 2.

IMPORTANT: Raise center halfway **BEFORE** unlocking rails.

Grasp the red handle on the center of the floor as shown.

Push down and turn handle. Then pull up approximately halfway to the top rails.

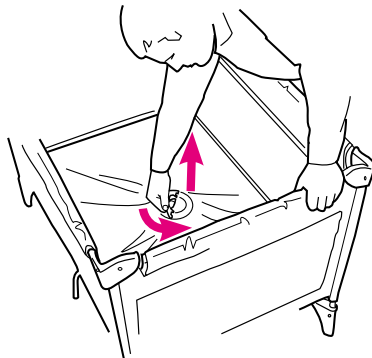

Step 3.

The top rail has a center piece with two tubes hidden under the fabric. The button on the bottom of the center piece releases the two tubes when it is pushed up.

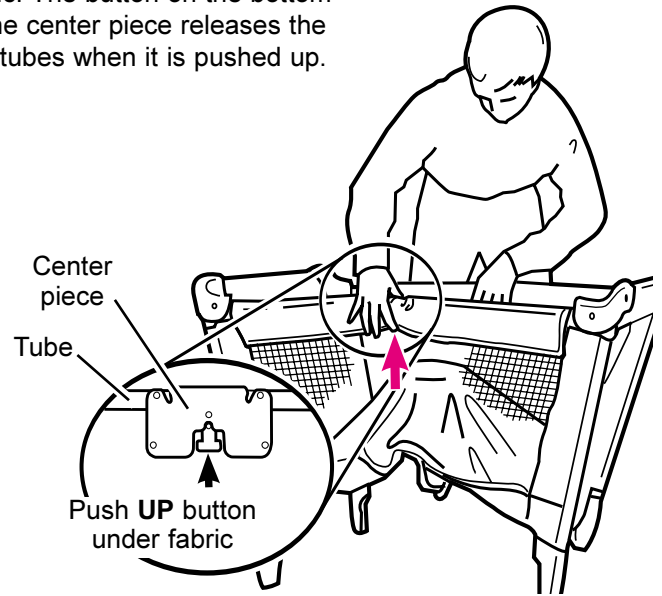

To fold the top rail:

- Lift up slightly on the top rail.
- Push up on the button located under the symbol to release the two tubes.
- Push down.



HINTS:

- If top rails do not unlatch, lift the center of the floor higher.
- Both tubes must be released for the top rail to fold.

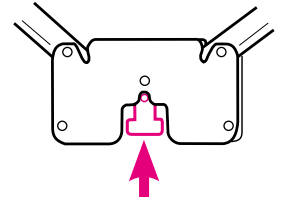

Step 4.

Pull center up all the way.

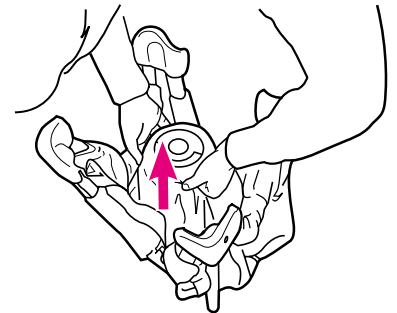

Step 5.

Gather your unit together.
Do not force.

If unit will not fold, look for a partially latched top rail. Squeeze the latch button to release the rail.

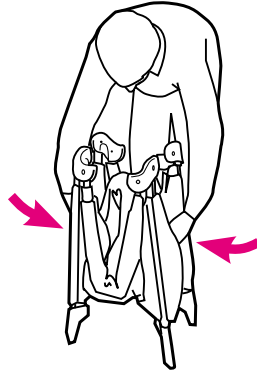

Step 6.

Find the bottom corner belt loop (only one). This loop is for holding unit and mattress together while carrying.

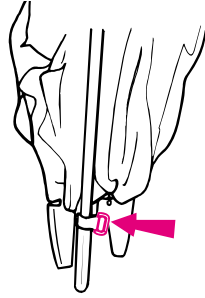

Step 7.

Wrap the mattress around your unit. Fasten together the VELCRO® straps, attaching the bottom strap to the bottom corner belt loop.

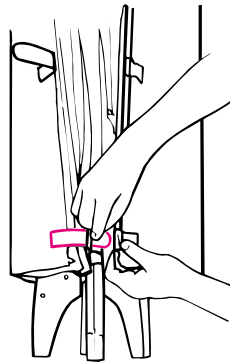

CARE AND MAINTENANCE

FROM TIME TO TIME CHECK YOUR PACK 'N PLAY for worn parts, torn material or stitching. Replace or repair the parts as needed. Use only Graco® replacement parts.

IF PACK 'N PLAY IS USED AT THE BEACH, you **MUST** clean sand off your Pack 'N Play, including the feet, before packing it into cover. Sand in top rail lock may damage it.

TO CLEAN PACK 'N PLAY, use only household soap or detergent and warm water.

TO WASH CARRY BAG AND FITTED SHEET, machine wash in lukewarm water on delicate cycle and drip-dry. **NO BLEACH.**

To Cover Your Pack 'N Play®

Models with changing table and wheels:

Pull the cover over your unit as shown, making sure carry handle attached to Pack 'N Play mattress is lined up with zipper.

Before pulling bag up, insert folded changing table into the side opposite the handle as shown. Pull bag up to cover end. Zip together.

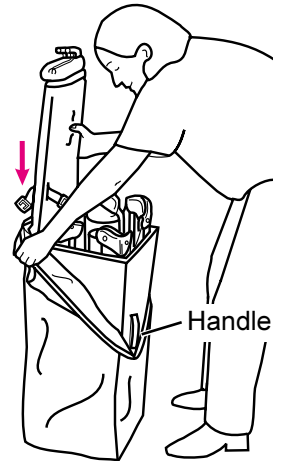

Models with wheels only:

Turn unit upside down, so that wheels point up. Pull the cover over your unit. Make sure carry handle attached to Pack 'N Play mattress is lined up with zipper.

Push the plastic end of the bag over wheels and feet. Turn unit over and pull bag up to cover end. Zip together.

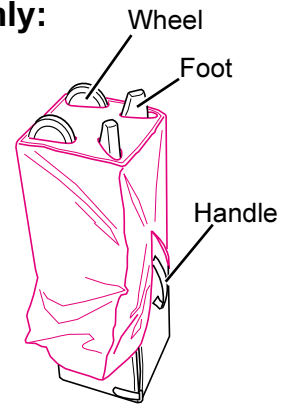

Models with feet or casters and feet:

Pull cover over your unit. Be sure carry handle attached to Pack 'N Play mattress is lined up with zipper. Turn unit over. Pull bag up to cover end. Zip together.

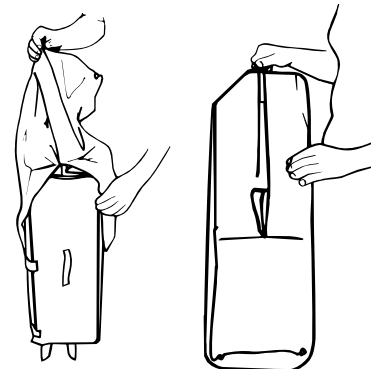

On certain models:

The cargo bag opens on either end. Slip the bag over the Pack 'N Play. Check that the carrying handle attached to the Pack 'N Play mattress sticks out the hole in the bag. Zip both ends.

BASSINET INSTRUCTIONS

PARTS LIST

CHECK that you have all the parts listed below BEFORE assembling your bassinet.

No tools required.

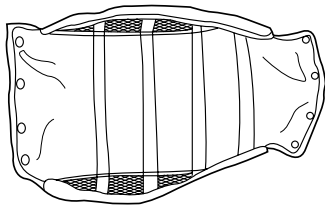

Bassinet

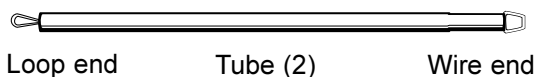

Loop end Tube (2) Wire end

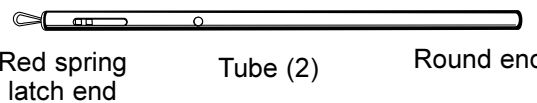

Red spring latch end Tube (2) Round end

To Install Your Bassinet

The four bassinet tubes are located in storage pockets sewn into the bassinet itself.

Step 1.

Insert wire end of one tube into the round end of a tube with a red spring latch.

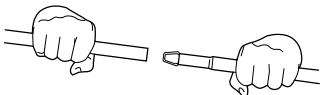

Repeat with other tubes.

Step 2.

Slide the assembled tubes into the tunnels on the sides of the bassinet.

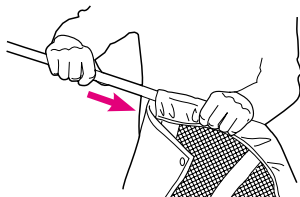

Step 3.

Lift bassinet by the two tubes and lower it into the Pack 'N Play. **Make sure the printed warnings on the end flap are facing up.**

Step 4.

Install the end of the tube **without** the red spring latch by placing the loop end into the slot in the plastic corner.

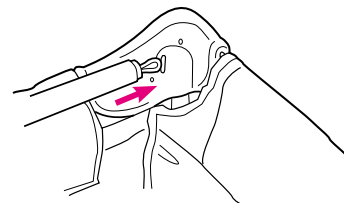

Step 5.

On the other end of the tube, pull back on the red spring latch and insert the loop into the slot in the plastic corner.

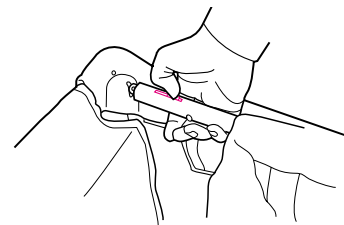

⚠ WARNING The loop ends must be in the slots in the corners to secure the bassinet in the Pack 'N Play. Pull up on the tube and bassinet to ensure that the tube is in place.

Step 6.

Repeat steps 4 and 5 on the other side of the bassinet.

Step 7.

Snap both of the end flaps of the bassinet to the Pack 'N Play with the eight snaps (four on each end).

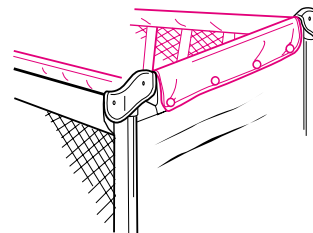

Step 8.

Place the mattress in the bassinet soft side up. Push down on the mattress to secure the mattress to the VELCRO® on the bassinet.

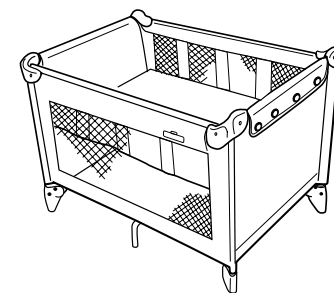

DO NOT use your bassinet without the mattress provided by Graco.

⚠ WARNING To avoid SUFFOCATION, DO NOT use extra padding such as a water mattress, mattress, or pillows inside the bassinet. Use **ONLY** mattress provided by Graco.

Your bassinet is now ready to use.

To Remove Your Bassinet

Step 1.

Remove the mattress from your bassinet.

Step 2.

Unsnap the end flaps from your Pack 'N Play.

Step 3.

Pull back the fabric at one corner of the bassinet to find the red spring latch.

Step 4.

Pull the red spring latch back and lift up the tube.

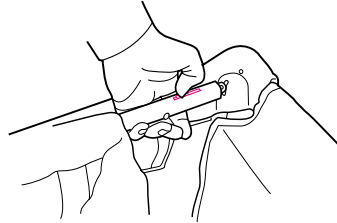

Step 5.

Pull the tube out of the bassinet and set aside.

Step 6.

Repeat steps 3, 4 and 5 to remove the other tube.

Step 7.

⚠ WARNING Use extreme care when pulling the tubes apart.

Pull the tubes apart by twisting the tubes as you pull. Store the tubes in the pockets in the bassinet.

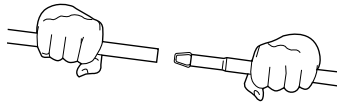

ACCESSORY INSTRUCTIONS ON CERTAIN MODELS*

Side Flap*

You can raise side flap if desired.

Unfasten VELCRO® straps at bottom of flap. Roll flap up. Fasten in place with snap loops at top.

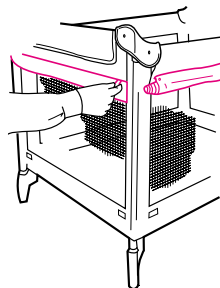

Cargo Bag*

The cargo bag can be snapped onto the end of the Pack 'N Play for easy access. Unzip both ends and tuck inside the bag. Maximum weight 5 lbs (2.3 kg).

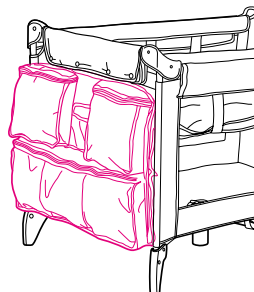

Casters*

To apply the locks, push **DOWN** on the levers.

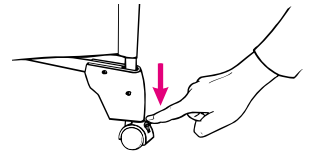

To release the locks, lift **UP** on the levers.

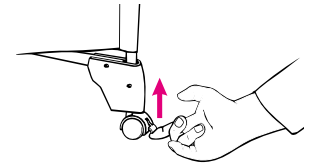

Wheels*

To apply the locks, push **DOWN** on the levers.

To release the locks, lift **UP** on the levers.

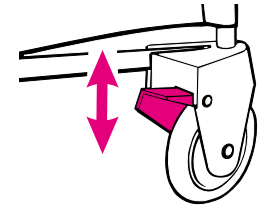

Parent Organizer*

⚠ WARNING Always keep objects out of child's reach. Remove parent organizer when child is able to pull himself up in the Pack 'N Play.

Step 1.

Your parent organizer includes two plastic dividers.

Slide the plastic dividers into the two pockets in the section dividers of the parent organizer.

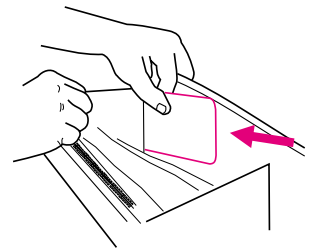

Step 2.

Slide the tube into the mounts on the end of your unit.

Push the button in to get it started.

Pull up on the parent organizer to make sure that the buttons are caught on the bottom of the mounts.

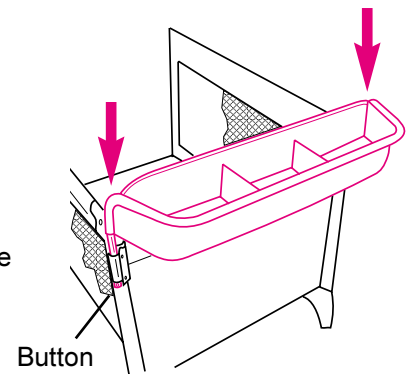

Step 3.

To remove the parent organizer push in on the buttons on the bottom of the tubes and pull up.

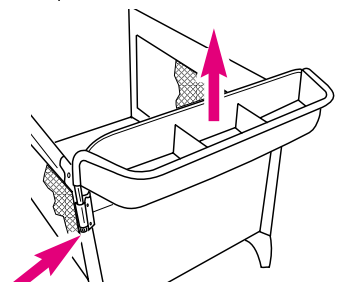

CHANGING TABLE INSTRUCTIONS (ON CERTAIN MODELS)

Parts List

CHECK that you have all parts listed below BEFORE assembling your changing table.
No tools required.

Long tube (2)

Short tube (2)

Changing pad

Changing table

Accessory bag

To Use Your Changing Table

▲ WARNING To protect your child from falls and other injuries:

- Always stay within arm's reach of your child when using the changing table. Always use waist belt when child is on the changing table. Never leave child unattended.
- The changing table is designed for use only with this Graco Pack 'N Play. Do not attempt to use it with any other product. Before each use, make sure the changing table is properly secured to the Pack 'N Play by pushing down firmly in the middle of the changing table. The changing table should not fall.
- Do not use the changing table as a sleeping or play area.
- Weight limit for the changing table is 25 pounds (11.3 kg). Do not use the changing table as extra storage. Always remove the changing table when your child is in the Pack 'N Play.
- The Pack 'N Play changing table can be used on the floor without being attached to the Pack 'N Play. Never place the changing table on a piece of furniture, bed, counter or any raised surface from which the changing table or your child could fall.

Step 1.

Lay changing table flat on floor **with short side in front of you and belt facing up**. Gently slide one long tube into opening on long side exactly as shown.

Repeat on other side.

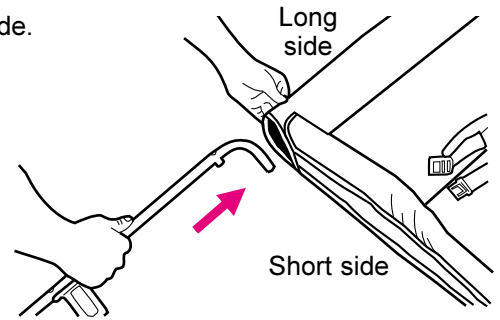

Step 2.

Slide one short tube into opening on end as shown.

For proper orientation, be sure folding side of hinge faces pad as shown.

DO NOT insert other short tube at this time.

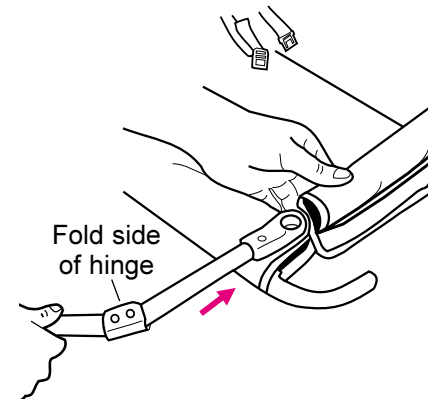

Step 3.

Turn up long tube so that its end points down.

Insert end of long tube into opening on end of short tube as shown.

DO NOT slide short tube up around the bend of long tube until you have finished next step.

Make sure fabric does not get caught in opening when inserting long tube into short tube.

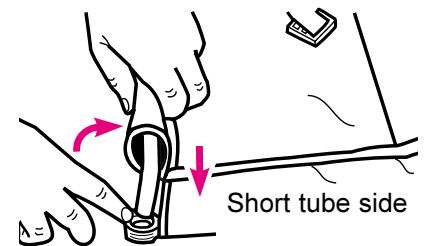

Step 4.

Repeat step 3 on other end of short tube, then **slide** short tube ends up onto long tubes.

TO AVOID TEARING FABRIC, slide this end up before proceeding with step 5.

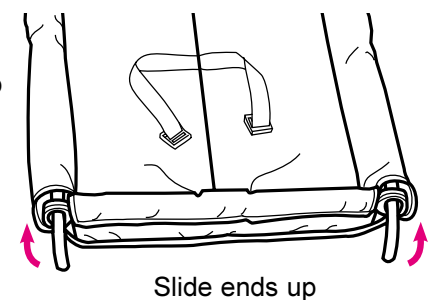

Step 5.

Repeat steps 2 and 3 on other end of changing table.

If the short tubes have been inserted correctly, the changing table should be able to FOLD UP in the center as shown.

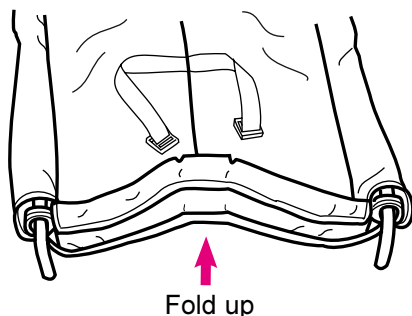

Step 6.

Place pad in changing table with vinyl side up. Pull belt straps through holes in center of pad.

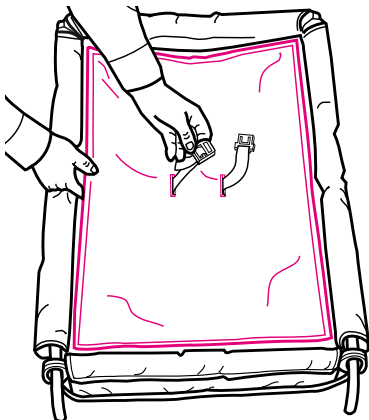

Step 7.

Insert VELCRO® straps into the four slots at the corners of changing table and attach to VELCRO® on underside of changing table. This will prevent pad from moving.

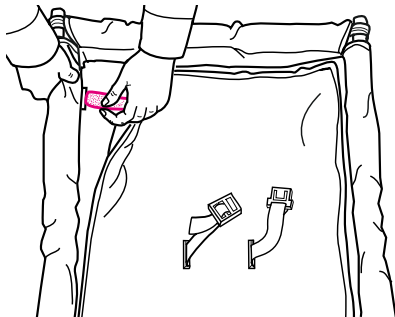

Step 8.

Place changing table on Pack 'N Play as shown. You may use your changing table with or without your bassinet installed. Make sure tubes are securely over the sides of the Pack 'N Play.

Check that the changing table is supported by the Pack 'N Play by pushing firmly down into center of changing table.

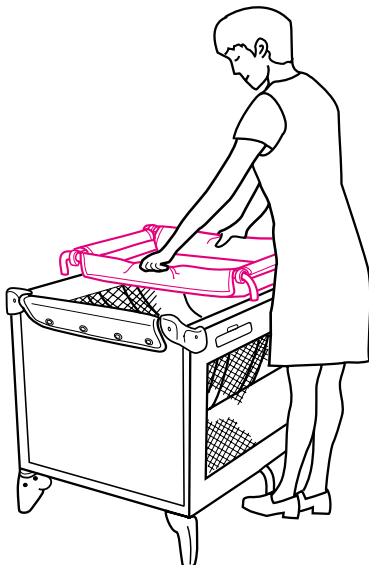

To Use Accessory Bag

If your bassinet is already installed, unsnap the four snaps on the bassinet end flap from either end of Pack 'N Play.

Step 1.

Snap accessory bag onto end of Pack 'N Play with four snaps as shown.

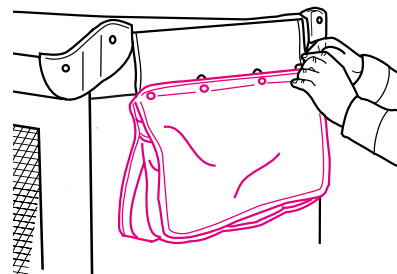

Step 2.

Snap bassinet end flap over the accessory bag with the four snaps.

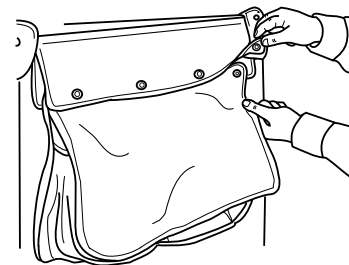

To Fold Changing Table

Step 1.

Pull up on waist belt straps to fold.

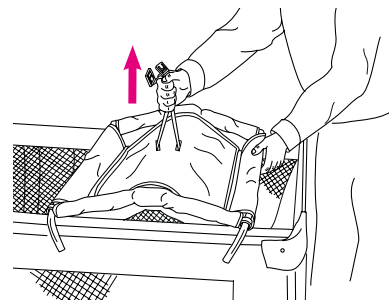

Step 2.

Ends of long tubes must point up when folded as shown.

Ends of tubes point up

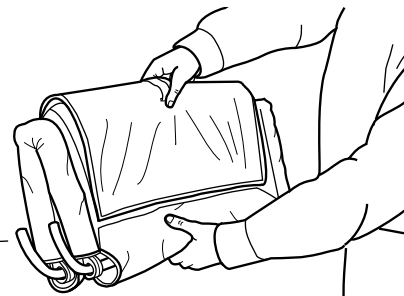

Step 3.

To carry or store your changing table with your folded Pack 'N Play, see "To Cover Your Pack 'N Play" section in these instructions.

Replacement Parts

Instructions for ordering Pack 'N Play® parts:

Complete form below. Your Pack 'N Play model number **MUST** be included on the form to ensure proper replacement parts. Your model number can be found on a label on the center of the bottom of the unit. **Payment must accompany your order.**

Parts List:	Price:**
Mattress	\$17.50
Carry bag	\$15.00
Cargo bag*	\$15.00
Caster assembly*	\$ 5.00 (each)/\$8.00 (2)
Wheels*	\$ 7.00 (each)/\$10.00 (2)
Fitted sheet	\$10.00

Bassinet parts:

Bassinet	\$17.00
Wire end tube	\$ 5.00
Round end tube	\$ 5.00

Changing table parts:

Long tube*	\$ 9.00
Short tube*	\$ 7.00
Changing pad*	\$10.00
Changing table*	\$15.00
Accessory bag*	\$ 7.00

* On certain models

** Prices subject to change without notice.

IF YOU NEED HELP

If you have any questions or if you need any part not listed, please call toll-free:

1-800-345-4109

or visit our Internet website, www.gracobaby.com.

Return the form below with payment to:
GRACO CHILDREN'S PRODUCTS INC.
CUSTOMER SERVICE DEPARTMENT
P.O. BOX 100, MAIN STREET
ELVERSON, PA 19520

Model Number	SHIP TO:
(Must be filled in)	Name
<input type="checkbox"/> Mattress	Address
<input type="checkbox"/> Carry bag	City, State, Zip
<input type="checkbox"/> Cargo bag	()
<input type="checkbox"/> Caster assembly	Telephone
<input type="checkbox"/> Wheels	
<input type="checkbox"/> Fitted sheet	
<input type="checkbox"/> Bassinet	
<input type="checkbox"/> Wire end tube	
<input type="checkbox"/> Round end tube	
<input type="checkbox"/> Long tube	<input type="checkbox"/> Check enclosed
<input type="checkbox"/> Short tube	(payable to Graco Children's
<input type="checkbox"/> Changing pad	Products Inc.)
<input type="checkbox"/> Changing table	<input type="checkbox"/> Charge to credit card:
<input type="checkbox"/> Accessory bag	<input type="checkbox"/> Visa
Total: _____	<input type="checkbox"/> MasterCard
Shipping	<input type="checkbox"/> Discover
& handling: <u>\$5.00</u>	Account #: _____
6% sales tax	Expiration date: _____
(PA only): _____	Signature: _____
Total amount	
due: _____	