

# GRACO®

## Tot Wheels Entertainer® Activity Center

### OWNER'S MANUAL

Model No. \_\_\_\_\_

Serial No. \_\_\_\_\_

Dear Customer,

Please fill in the model and serial numbers above from the label on the underside of the tray.



**Models 4430 and 4440 Series**

### Congratulations on your purchase of a Graco® Tot Wheels Entertainer® activity center!

Graco is the recognized leader in the design and manufacture of quality baby products. We believe your new Graco® Tot Wheels Entertainer® activity center is a wise choice, promising many hours of enjoyment for your baby.

Before using your activity center, please take a few minutes to read this Owner's Manual. The short time you spend reading these instructions will help you use your activity center properly.

### Customer Satisfaction

Our goal is to make every product the best it can be! We are also committed to supporting our products after purchase. If you would like to speak with us about your product, please contact our **Customer Service Department at 1-800-345-4109** or visit our Internet website, [www.gracobaby.com](http://www.gracobaby.com). Our knowledgeable staff will be ready to answer any questions you may have concerning parts, use or maintenance. When you call, please have the **model and serial numbers** ready so your call may be processed quickly and efficiently.

**WARNING**

Graco is concerned about the safety of every child who uses one of our products. We are equally concerned about the safety of their children. There are many ways to help minimize the risk that a baby using one of our mobile activity centers. The charge of the baby should always follow these rules.

### 1. Never leave your baby unattended.

Most accidents happen to children while they are unsupervised. Be sure to watch the baby at all times keeping the baby under a watchful eye. Be sure to watch the baby's speed and is eager to explore all sorts of potential hazards, directly or indirectly, at all times. If you believe proper supervision of your baby cannot be guaranteed, which the baby cannot be adequately protected while using our mobile activity center, and that you consider instead an activity center without wheels, stop using it.

### 2. Properly prepare your baby's play space.

Potential hazards in the room must be removed or guarded against. Be sure to keep in mind that the mobile activity center gives the baby the ability to reach, pull, push, or otherwise be possible. That means it's important to prepare play space by removing, reach, and closing doors to keep the baby away from potential hazards.

- Stairs
- Steps
- Raised thresholds
- Driveways and sidewalks
- Ramps or inclines
- Decks
- Ranges, heaters, fireplaces, hot liquids and other heat sources
- Blinds
- Objects
- Dangers
- Pots
- Bookshelves
- Bathrooms
- Swimming pools
- Any other hazards

**Only your commitment to safety can give you peace of mind.**

### When to use your Tot Wheels Entertainer

- Your baby should be able to sit unaided and be able to support most of his/her body weight with his/her legs (about 6 months old).
- Both feet should be able to touch the floor.

### When NOT to use your Tot Wheels Entertainer

- Do not use until your child can sit up alone.
- When your child can walk unaided.
- When your child reaches 30 lbs. in weight.
- When your child has grown over 32 inches in height.
- If your activity center has become broken or damaged.
- If you haven't prepared a safe play space for your baby.

### Other things to avoid

- Don't lift or carry your baby in the activity center.
- Don't adjust the activity center with your baby in it.
- Don't use the activity center for commercial use.
- Don't use the activity center if it is broken or damaged.

Graco® activity centers have been designed with your child's enjoyment in mind. By following these guidelines and using simple common sense. Let's

# Let's play safe.

of our products. We know that parents and other caregivers are certain safety precautions which you must always take to ensure your child will be harmed. Specifically, the parent or caregiver in

At a minimum, the caregiver should be in the same room with the child to ensure a baby can propel a mobile activity center at surprising speed and diligent supervision by the caregiver is required at all times. If your home is not guaranteed, or that your home presents particular dangers from the use of a mobile activity center, we suggest that you not use this product in favor of a swing, playard, or other fine Graco® product for your baby.

## Prepare play space — neutralize potential hazards.

Before placing a baby in a mobile activity center. Keep in mind that a baby can move around the play area much more quickly than you would expect. To prepare play space by installing and using gates, removing objects from the play area, and hazards, such as:

- Drape cords
- Objects on tables
- Hanging electrical cords or small appliances
- Pots and pans on stoves
- Toys on shelves
- Bathtubs or open toilets
- Swimming pools or other containers filled with liquid
- Other dangers unique to your environment

Ensure your child the safe, happy playtime you desire.

## Trainer® activity center

- When you are able to watch your baby at all times while playing in the activity center.
- When you have prepared your baby's play space according to these guidelines.

## Entertainer® activity center

- If the tray of your activity center is lower than your baby's waist level when your child stands in the activity center.
- If you haven't blocked access to stairs and steps.
- If you haven't assembled the activity center according to these instructions.

- Don't use the activity center with your child in it on a table or countertop.
- Keep dangling electrical cords out of baby's reach, such as an iron on an ironing board, lamp cords, etc.

Keep in mind. It is your responsibility to ensure your baby's safety. We work together to keep your baby safe and happy.

## ⚠ WARNING

### STAIR HAZARD:

Avoid serious injury or death. Block stairs/steps securely before using walker.



Avoid falls and other hazards. Never allow walker to be pushed while child is in it.

Never leave child unattended. Always keep child in view while in walker.

Use only on flat surfaces free of objects that could cause the walker to tip over.

To avoid burns, keep your child away from hot liquids, ranges, radiators, space heaters, fireplaces, etc.

To reduce the chance of your child slipping out of the seat, check that both of your child's feet touch the floor.

Never carry the product with the child in it.

Discontinue using walker should it become damaged or broken.

Read all instructions before assembly and use of this product.

Keep instructions for future use.

## PARTS LIST

CHECK that you have all the parts listed below BEFORE assembling your activity center.

If any parts are missing, call Customer Service at 1-800-345-4109 or visit our Internet website, [www.gracobaby.com](http://www.gracobaby.com).

THIS PRODUCT REQUIRES ADULT ASSEMBLY.

Tools required: Wrench or pliers, screwdriver

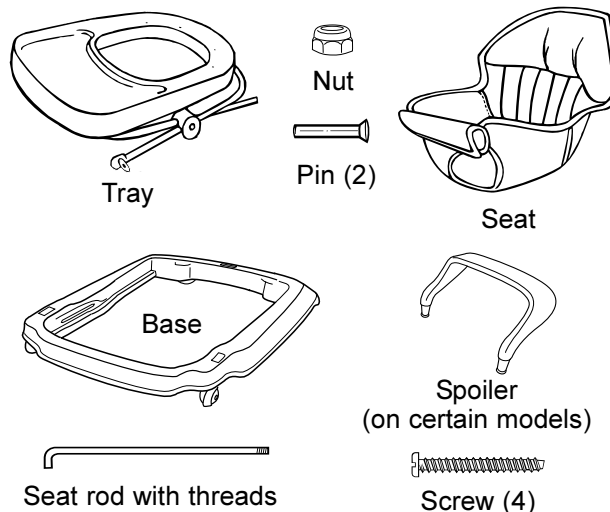

## To Attach Seat

### Step 1.

On playtray models, remove playtray from activity center tray by unsnapping both side tabs from under tray.



### Step 2.

Insert the pegs on the seat back into the four holes located at the rear of the tray.

Underneath the tray, insert the four screws into the centers of the pegs. Press down on the seat back to help the screws connect with pegs. **Tighten the screws securely, but do not overtighten.**

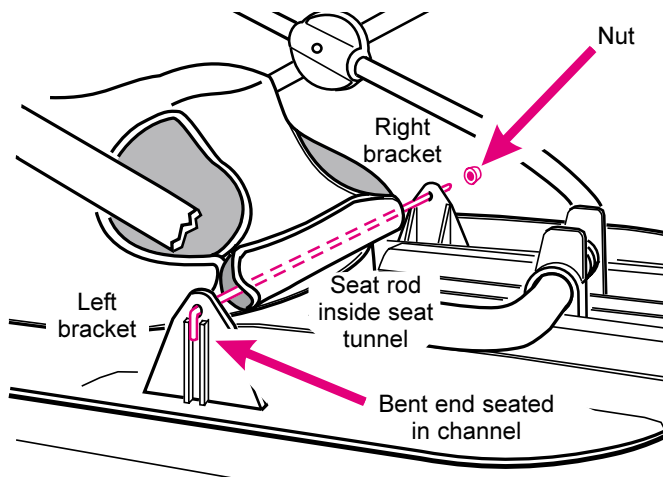
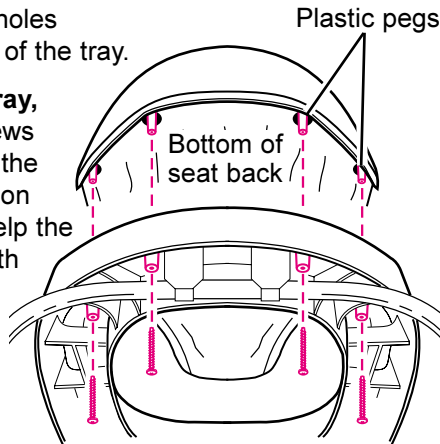

### Step 3.

With the tray assembly upside down and its front facing you, pull up on one of the tube ends until the tubes snap into the first height position.

Insert seat rod through hole in left bracket, then through the tunnel of the seat.

### Step 4.

Now push the threaded end of the seat rod through the right bracket hole. Turn the bent end of the rod so it fits securely into the left bracket channel. Push it into place.

Place nut on seat rod threads and **tighten securely** with wrench or pliers.

## To Attach Base

### Step 1.

Place base on floor with wheels down.

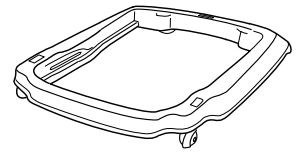

### Step 2.

Open tubes of tray assembly as shown until they latch.



### Step 3.

Front tube has plastic "T" ends. Tilt tray assembly as shown. Insert one plastic "T" into slot on the inside front of the base. Repeat on opposite side, flexing tube inward if needed to engage the slot.

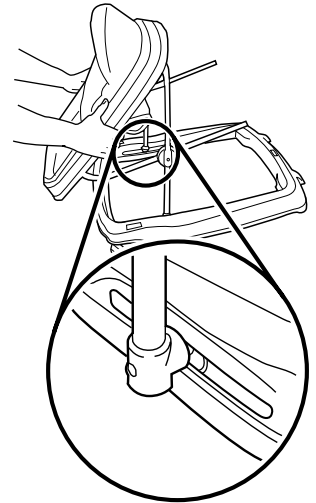

### Step 4.

Lower rear tube so holes in ends of tube line up with two holes in back of activity center base.

Be sure that plastic "T" pieces remain in their slots.

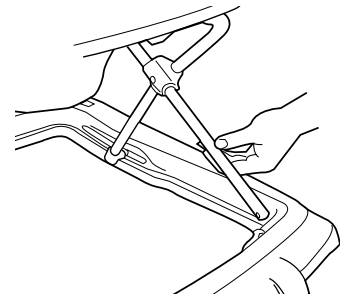

### Step 5.

Insert pin into hole as shown, through tray tube, and out through base hole on the other side.

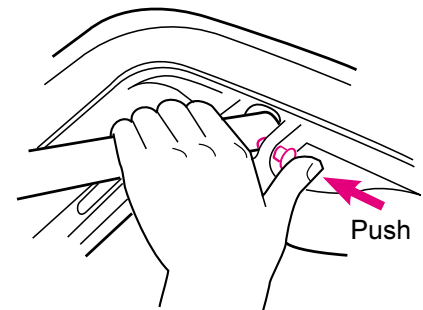

**Press firmly** until tab snaps over head of pin. Repeat on other side.

**Be sure all parts of tray and base are securely fastened, with "T" pieces in their slots and tabs holding pins firmly.**

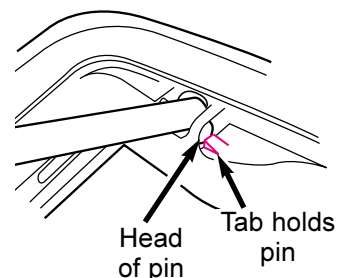

## To Attach Decals

Place decals on front of the tray and base as shown. **Rub over decals with hand or clean cloth to assure adhesion.**



## To Adjust the Activity Center

**⚠ WARNING** Remove your child from the activity center before making any adjustments.

### Step 1.

To raise your activity center, hold the base with one hand while lifting the tray with the other hand.

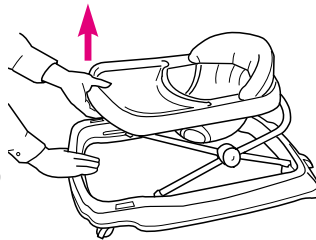

Adjust the tray so that it is no lower than waist level when your child is standing in the activity center.

### Step 2.

To lower (or fold) your activity center, reach underneath the tray and squeeze the finger latches, **holding them in** while you lower the tray. Tray should lower easily. **DO NOT force tray down** or unit could be damaged.

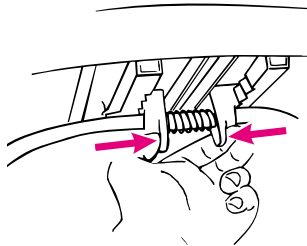

## To Use Parking Stands (on certain models)

To install parking stands (two in the front and one in the back), lift base slightly, depress button on front of stands and push stands up until they snap into place.

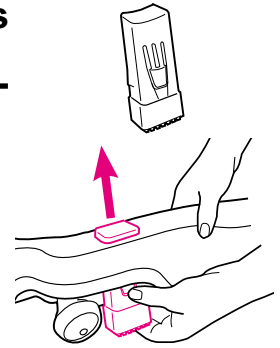

To use parking stands, lift base slightly and push stands down until they snap into place.

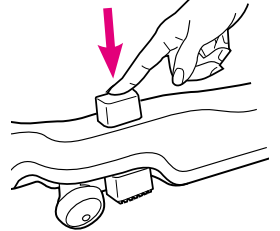

To release parking stands, lift base slightly and depress button on front of stands. Push stands upward into storage position.

## ⚠ WARNING

- When parking stands are in use, it is still possible for your child to move the activity center.
- Be sure to engage both parking stands.
- Never place the activity center on a table or countertop.

## Friction Strip Feature

**⚠ WARNING** Avoid serious injury or death. **DO NOT** use product without the five friction strips under the base.

- Make sure strips are kept clean.
- Clean strips with WATER ONLY.

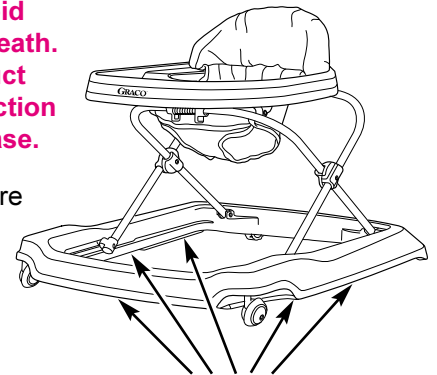

Friction strips under base

## Caring for the Activity Center

Make sure five friction strips under base are kept clean. Clean with water only.

For cleaning vinyl seat, metal and plastic parts other than friction strips, use only household soap or detergent and warm water. **NO BLEACH.**

Excessive exposure to sun or heat could cause fading or warping of parts.

## To Assemble the Playtray (on certain models)

**Do not install the playtray while your baby is in the activity center.**

CHECK that you have all the parts listed at right before assembling your playtray.

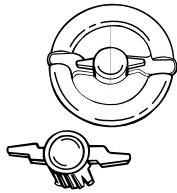

Steering wheel and cap



Teether and stalk (style may vary)



Phone and cord

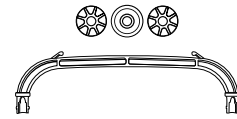

Bar, two beads, one ring



Music key (3)



Stickers

### Step 1.

Assemble the toys on the tray as shown.

Push and twist the ring and two beads onto the toy bar.

Snap the toy bar into the holes in the playtray; **slight curve in toy bar must curve away from steering wheel**. Be sure both ends of the toy bar are firmly snapped into the playtray.

Once the toy bar is inserted into the playtray, you will not be able to remove it.

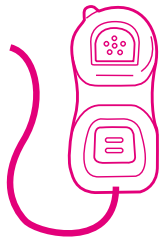

Push end of phone cord through small hole in tray, then tie a knot under the tray.

Pull on phone cord to make sure cord is secure.

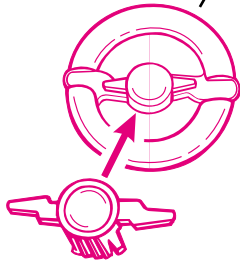
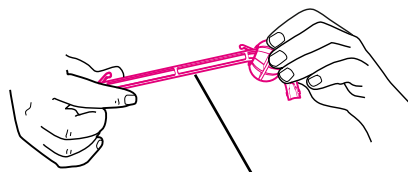

Push wheel cap onto steering wheel, then push assembly into large hole in tray. Check that all four tabs go into hole in tray.

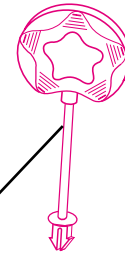

Insert teether stalk into the small square hole in the tray.



Snap music keys in place over the printed circuit board.

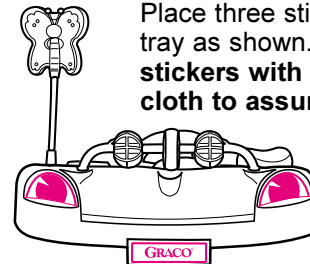

Place three stickers on front of tray as shown. **Rub over stickers with hand or clean cloth to assure adhesion.**

### Step 2.

Line up front of playtray with front edge of activity center tray as shown.

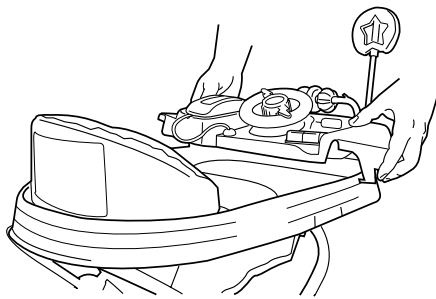

### Step 3.

Push playtray down so both side tabs snap under the activity center tray.

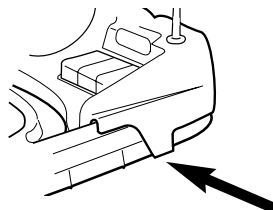

### Step 4.

CHECK that playtray is secure on activity center by pulling up on playtray.

**▲WARNING Do not lift this product by the playtray.**

### To Remove the Playtray

To remove tray, pull the two side tabs outward, and lift up playtray.

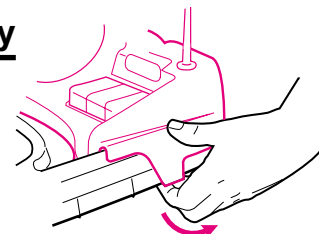

## To Assemble the Mix 'N Move® Toy Gym (on certain models)

Before assembling, check that you have all the parts listed below:

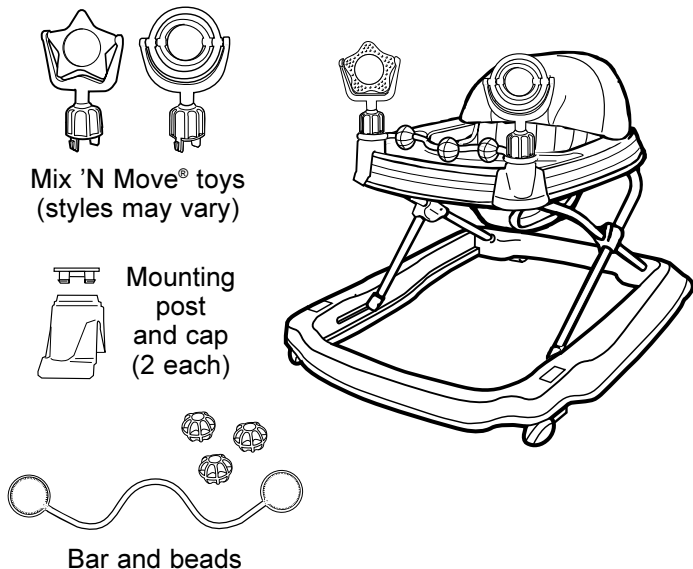

### Step 1.

To mount beads on bar: flatten ring at one end of bar as shown and push through hole in center of each bead.

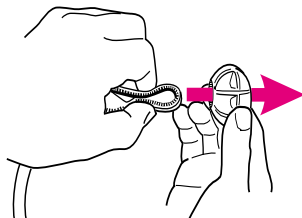

### Step 2.

Place ring on top of a mounting post. Shorter teeth must be on the bottom, as shown. Top of mounting post will be even with top of ring. Snap cap into place inside mounting post and turn it up to one half turn until it locks in place. Repeat with the other ring, post and cap.

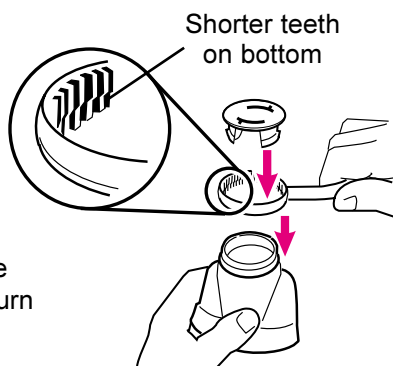

### Step 3.

Mount posts onto front corners of activity center tray as shown until they snap securely into place. Center of bar should curve away from the seat, not toward it.

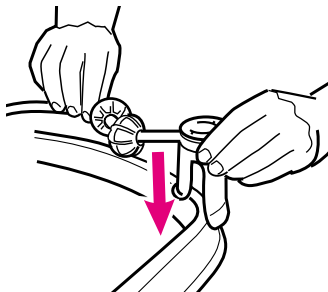

### Step 4.

Insert the two prongs on a toy base into a cap at the notches.

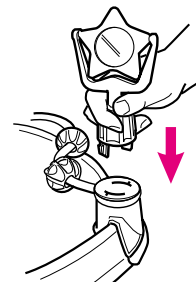

### Step 5.

Turn toy base one quarter turn until you feel the toy snap into place. Check that toy is firmly inserted by pulling on the toy.

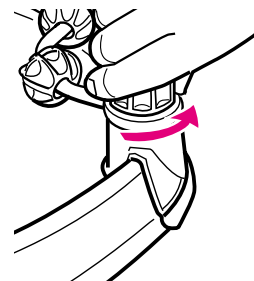

Toy is removable (turn it the other way with a little pressure) so that you can replace it with other toys when desired (sold separately—see the enclosed leaflet).

## To Attach the Spoiler (on certain models)

Line up the pegs on the bottom of the spoiler with the two holes at the back of the activity center and push the spoiler in until it snaps in place. It will not be removable.

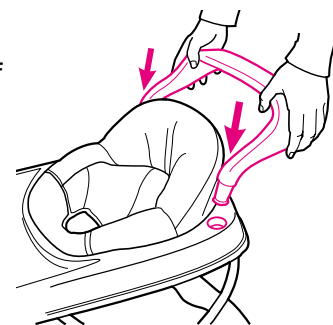

**Do not allow spoiler to block seat by inserting it backwards.**

**⚠ WARNING Avoid falls and other hazards. Never allow unit to be pushed while child is in product.**

# Replacement Parts

## Instructions for ordering activity center parts:

Complete form below. Your activity center model number **MUST** be included on the form to ensure proper replacement parts. **Your model number can be found on a sticker on the underside of the tray. Payment must accompany your order.**

<b>Parts List:</b>	<b>Price:**</b>
Tray .....	\$ 15.00
Seat .....	\$ 13.00
Rear wheel .....	\$ 8.00 (each)
Seat rod/nut .....	\$ 7.00
Caster .....	\$ 5.00 (each)
Hardware .....	\$ 5.00
Pin .....	no charge
Parking stand* .....	\$ 5.00 (each)
Mix 'N Move toy gym* .....	\$ 18.00
Mix 'N Move star* .....	\$ 8.00
Mix 'N Move spinning rings* .....	\$ 8.00
Playtray with all toys* .....	\$ 20.00
Spoiler* .....	\$ 7.00

\* Certain models only

\*\* Prices subject to change without notice.

## IF YOU NEED HELP

If you have any questions or if you need any part not listed, please call toll-free:

**1-800-345-4109**

or visit our Internet website, [www.gracobaby.com](http://www.gracobaby.com).

Return the form below with payment to:  
**GRACO CHILDREN'S PRODUCTS INC.**  
**CUSTOMER SERVICE DEPARTMENT**  
**P.O. BOX 100, MAIN STREET**  
**ELVERSON, PA 19520**

<b>Model Number</b>	<b>SHIP TO:</b>
(Must be filled in)	Name _____
<input type="checkbox"/> Tray	Address _____
<input type="checkbox"/> Seat	City, State, Zip _____
<input type="checkbox"/> Rear wheel	( ) _____
<input type="checkbox"/> Seat rod/nut	Telephone _____
<input type="checkbox"/> Caster	
<input type="checkbox"/> Hardware	<input type="checkbox"/> Check enclosed
<input type="checkbox"/> Pin	(payable to Graco Children's Products Inc.)
<input type="checkbox"/> Parking stand	<input type="checkbox"/> Charge to credit card:
<input type="checkbox"/> Toy gym	<input type="checkbox"/> Visa
<input type="checkbox"/> Star	<input type="checkbox"/> MasterCard
<input type="checkbox"/> Spinning rings	<input type="checkbox"/> Discover
<input type="checkbox"/> Playtray with toys	
<input type="checkbox"/> Spoiler	
Total: _____	Account #: _____
Shipping & handling*: <u>      \$5.00      </u>	Expiration date: _____
6% sales tax (PA only): _____	Signature: _____
Total amount due: _____	
*Outside the continental U.S., please call for shipping cost.	