

Genesis

Multi-Purpose Oscillating Tool Operator's Manual

**Outil oscillant à usages multiples
Manuel d'utilisation**

**Herramienta oscilante multiuso
Manual del Operario**



GMT15A

Multi-Purpose Oscillating Tool Operator's Manual

1.5 AMP

Specifications:

- Model: GMT15A
- Rated Input: 120V~AC, 60HZ, 1.5A
- No Load Speed: 21,000/min (OPM)

Includes: Oscillating Tool, Hook & Loop Sanding Pad, Assorted Sandpaper, Rigid Scraper Blade, 1-3/16" (30mm) E-Cut (Flush Cut) Saw Blade, 3" Wood & Drywall Saw Blade, and Wrench

WARNING:

To reduce the risk of injury, user must read and understand this operator's manual before operating this tool. Save this Manual for future reference.

Toll-Free Help Line: 1-888-552-8665.



WARNING:

The Operation of any power tool can result in foreign objects being thrown into your eyes, which can result in severe eye damage. Before beginning tool operation, always wear safety goggles or safety glasses with side shields and a full face shield when needed. We recommend Wide Vision Safety Mask for use over eyeglasses or standard safety glasses with side shields. Always wear eye protection which is marked to comply with ANSI Z87.1.



Look for this symbol to point out important safety precautions. It means attention!!! Your safety is involved.

GENERAL SAFETY RULES

WARNING:

Some dust created by power sanding, sawing, grinding, drilling, and other construction activities contains chemicals known to cause cancer, birth defects or other reproductive harm. Some examples of these chemicals are:

- lead from lead-based paints,
- crystalline silica from bricks and cement and other masonry products, and
- arsenic and chromium from chemically treated lumber.

Your risk from these exposures varies, depending on how often you do this type of work. To reduce your exposure to these chemicals: work in a well ventilated area, and work with approved safety equipment, such as those dust masks that are specially designed to filter out microscopic particles.

⚠ WARNING:

READ AND UNDERSTAND ALL WARNINGS, CAUTIONS AND OPERATING INSTRUCTIONS BEFORE USING THIS EQUIPMENT. Failure to follow all instructions listed below may result in electric shock, fire and/or serious personal injury.

SAVE THESE INSTRUCTIONS**WORK AREA SAFETY:**

- **Keep your work area clean and well lit.** Cluttered benches and dark areas invite accidents.
- **Do not operate power tools in explosive atmospheres,** such as in the presence of flammable liquids, gases, or dust. Power tools create sparks which may ignite the dust or fumes.
- **Keep bystanders, children, and visitors away while operating a power tool.** Distractions can cause you to lose control.

ELECTRICAL SAFETY

- **Power tool plugs must match the outlet.** Never modify the plug in any way. Do not use any adapter plugs in any earthed (grounded) power tools. Double insulated tools are equipped with a polarized plug (one blade is wider than the other). This plug will fit in a polarized outlet only one way. If the plug does not fit fully in the outlet, reverse the plug. If it still does not fit, contact a qualified electrician to install a polarized outlet. Do not change the plug in any way. Double insulation eliminates the need for the three wire grounded power cord and grounded power supply system.
- **Do not expose power tools to rain or wet conditions.** Water entering a power tool will increase the risk of electric shock.
- **Avoid body contact with earthed or grounded surfaces such as pipes, radiators, ranges and refrigerators.** There is an increased risk of electric shock if your body is grounded.
- **Do not abuse the cord.** Never use the cord for carrying, pulling or unplugging the power tool. Keep cord away from heat, oil, sharp edges or moving parts. Damaged cords increase the risk of electric shock.
- **When operating a power tool outside, use an extension cord suitable for outdoor use.** These cords are rated for outdoor use and reduce the risk of electric shock.
- **Do not use AC only rated tools with a DC power supply.** While the tool may appear to work. The electrical components of the AC rated tool are likely to fail and rate a hazard to the operator.

PERSONAL SAFETY

- **Stay alert,** watch what you are doing and use common sense when operating a power tool. Do not use tool while tired or under the influence of drugs, alcohol, or medication. A moment of inattention while operating power tools may result in serious personal injury.
- **Use safety equipment.** Always wear eye protection. Safety equipment such as dust mask, non-skid safety shoes, hard hat, or hearing protection for appropriate conditions will reduce personal injuries.
- **Dress properly.** Do not wear loose clothing or jewelry. Keep your hair, clothing and gloves away from moving parts. Loose clothes, jewelry or long hair can be caught in moving parts. Air vents may cover moving parts and should be avoided.
- **Avoid accidental starting.** Ensure the switch is in the off position before plugging in. Carrying power tool with your finger on the switch or plugging in power tools that have the switch on invites accidents.
- **Remove any adjusting keys or wrenches before turning the power tool on.** A wrench or key that is left attached to a rotating part of the tool may result in personal injury.
- **Do not overreach.** Maintain proper footing and balance at all times. Loss of balance can cause an injury in an unexpected situation.
- **If devices are provided for connection of dust extraction and collection facilities, ensure these are connected and properly used.** Use of these devices can reduce dust related hazards.
- **Do not use a ladder or unstable support.** Stable footing on a solid surface enables better control of the tool in unexpected situations.
- **Keep tool handles dry, clean and free from oil and grease.** Slippery handles cannot safely control the tool.

TOOL USE AND CARE

- **Secure the work piece.** Use clamp or other practical way to hold the work piece to a stable platform. Holding the work piece by hand or against your body is unstable and may lead to loss of control.

- **Do not force the power tool.** The tool will perform the job better and safer at the feed rate for which it is designed. Forcing the tool could possibly damage the tool and may result in personal injury.
- **Use the correct power tool for the job.** Don't force the tool or attachment to do a job for which it is not designed.
- **Do not use tool if switch does not turn it on or off.** Any tool that cannot be controlled with the switch is dangerous and must be repaired or replaced by an authorized service center.
- **Turn power tool off, and disconnect the plug** from the power source and/or battery pack from the power tool before making any adjustments, changing the accessories, or storing the tools. Such preventive safety measures reduce the risk of an accidental start up which may cause personal injury.
- **Store idle tool out of reach of children and other inexperienced persons.** It is dangerous in the hand of untrained users.
- **Maintain power tools with care.** Check for proper alignment and binding of moving parts, component breaks, and any other conditions that may affect the tool's operation. A guard or any other part that is damaged must be properly repaired or replaced by an authorized service center to avoid risk of personal injury.
- **Use recommended accessories.** Using accessories and attachments not recommended by the manufacturer or intended for use on this type tool may cause damage to the tool or result in personal injury to the user. Consult the operator's manual for recommended accessories.
- **Keep cutting tools sharp and clean.** Properly maintained cutting tools with sharp cutting edges are less likely to bind and are easier to control.
- **Feed the work piece in the correct direction and speed.** Feed the work piece into a blade, cutter, or abrasive surface against the direction of the cutting tool's direction of rotation only. Incorrectly feeding the work piece in the same direction may cause the work piece to be thrown out at high speed.
- **Never leave the tool running unattended, turn the power off.** Do not leave the tool until it comes to a complete stop.
- **Never start the power tool when any rotating component is in contact with the work piece.**

WARNING:

USE OF THIS TOOL CAN GENERATE AND DISBURSE DUST OR OTHER AIRBORNE PARTICLES, INCLUDING WOOD DUST, CRYSTALLINE SILICA DUST AND ASBESTOS. Direct particles away from face and body. Always operate tool in a well-ventilated area and provide for proper dust removal. Use dust collection system wherever possible. Exposure to the dust may cause serious and permanent respiratory or other injury, including silicosis (a serious lung disease), cancer, and death. Avoid breathing the dust, and avoid prolonged contact with the dust. Allowing dust to get into your mouth or eyes, or lay on your skin may promote absorption of harmful material. Always use properly fitting NIOSH/OSHA approved respiratory protection appropriate for dust exposure, and wash exposed areas with soap and water.

SERVICE

- **Have Your Power Tool Serviced by a qualified repair person using only identical replacement parts.**
This will ensure that the safety of the power tool is maintained.
- **Service Your Power Tool periodically.** When cleaning a tool, be careful not to disassemble any portion of the tool since internal wires may be misplaced or pinched.

WARNING:

READ AND UNDERSTAND ALL WARNINGS, CAUTIONS AND OPERATING INSTRUCTIONS BEFORE USING THIS EQUIPMENT. Failure to follow all instructions listed below may result in electric shock, fire and/or serious personal injury.

SAVE THESE INSTRUCTIONS

EXTENSION CORDS

Grounded tools require a three wire extension cord. Double insulated tools can use either a two or three wire extension cord. As the distance from the power supply outlet increases, you must use a heavier gauge extension cord. Using extension cords with inadequately sized wire causes a serious drop in voltage, resulting in loss of power and possible tool damage. Refer to the table shown below to determine the required minimum wire size.

The smaller the gauge number of the wire, the greater the capacity of the cord. For example: a 14-gauge cord can carry a higher current than a 16-gauge cord. When using more than one extension cord to make up the total length, be sure each cord contains at least the minimum wire size required. If you are using one extension cord for more than one tool, add the nameplate amperes and use the sum to determine the required minimum wire size.

Guidelines for Using Extension Cords

- If you are using an extension cord outdoors, be sure it is marked with the suffix “W-A” (“W” in Canada) to indicate that it is acceptable for outdoor use.
- Be sure your extension cord is properly wired and in good electrical condition. Always replace a damaged extension cord or have it repaired by a qualified person before using it.
- Protect your extension cords from sharp objects, excessive heat, and damp or wet areas.

Recommended Minimum Wire Gauge for Extension Cords (120 Volt)						
Nameplate Amperes (At Full Load)	Extension Cord Length					
	25 Feet	50 Feet	75 Feet	100 Feet	150 Feet	200 Feet
0–2.0	18	18	18	18	16	16
2.1–3.4	18	18	18	16	14	14
3.5–5.0	18	18	16	14	12	12
5.1–7.0	18	16	14	12	12	10
7.1–12.0	18	14	12	10	8	8
12.1–16.0	14	12	10	10	8	6
16.1–20.0	12	10	8	8	6	6

SPECIFIC SAFETY RULES FOR MULTI-PURPOSE OSCILLATING TOOLS

⚠ WARNING: DO NOT LET COMFORT OR FAMILIARITY WITH PRODUCT (GAINED FROM REPEATED USE) REPLACE STRICT ADHERENCE TO PRODUCT SAFETY RULES. If you use this tool unsafely or incorrectly, you can suffer serious personal injury!

⚠ WARNING: Hold tool by insulated gripping surfaces when performing an operation where cutting tools may contact hidden wiring or its own cord. Contact with a “live” wire will make exposed metal parts of the tool “live” and shock the operator!

- **Always wear safety glasses or goggles.** Normal prescription eye or sunglasses are not safety glasses.
- **Hold the Oscillating Tool by its insulated gripping surfaces to avoid electrical shock from unseen “live” wires.**
- **Always hold the tool firmly. DO not** leave the tool running unless hand held.
- **Check your work area for proper clearances before cutting.** This will avoid cutting into your workbench, the floor, etc.
- **DO not cut nails or screws** unless you are using a blade specifically designed for this purpose. Inspect your material before cutting.
- **Before switching on the tool,** be sure the blade is not contacting the work piece.
- **Do not use tool if switch does not turn it on or off.** Any tool which can not be controlled by the switch is dangerous and must be repaired.
- **Wear cushioned protective gloves to minimize the vibration.** Excessive vibration may cause personal injury.
- **Do not wet-sand with this tool.** Water or moisture entering the motor housing can cause electric shock and serious personal injury.
- **Always be sure that the tool is switched off and unplugged before adjusting,** adding accessories, or checking a function on the tool.

⚠ WARNING:

USE OF THIS TOOL CAN GENERATE AND DISBURSE DUST OR OTHER AIRBORNE PARTICLES, INCLUDING WOOD DUST, CRYSTALLINE SILICA DUST AND ASBESTOS. Direct particles away from face and body. Always operate tool in a well-ventilated area and provide for proper dust removal. Use dust collection system wherever possible. Exposure to the dust may cause serious and permanent respiratory or other injury, including silicosis (a serious lung disease), cancer, and death. Avoid breathing the dust, and avoid prolonged contact with the dust. Allowing dust to get into your mouth or eyes, or lay on your skin may promote absorption of harmful material. Always use properly fitting NIOSH/OSHA approved respiratory protection appropriate for dust exposure, and wash exposed areas with soap and water.

YOUR MULTI-PURPOSE OSCILLATING TOOL

1. ON/OFF Switch
2. Cast Aluminum Gear Head
3. Oscillating Spindle and Blade holder
4. Flush Cutting Blade 1-3/16"
5. 3" Wood and Drywall saw Blade
6. Rigid Scraper blade
7. Hook & Loop Sanding Pad
8. Sandpaper

**Unpacking and Content**

IMPORTANT: Due to modern mass production techniques, it is unlikely the tool is faulty or that a part is missing. If you find anything wrong, do not operate the tool until the parts have been replaced or the fault has been rectified. Failure to do so could result in serious personal injury.

Contents in Package:

Description	QTY
Oscillating Tool	1
1-3/16" (30mm) Flush Saw Blade	1
3" Wood and Drywall Saw Blade	1
Rigid Scraper Blade	1
Hook & Loop Sanding Pad	1
Sandpaper	3
Allen Wrench	1
Cap screw and washers	1
Operator's Manual	1

ASSEMBLY AND ADJUSTMENTS

⚠ WARNING: Always be sure that the tool is switched off and unplugged before adjusting, adding accessories, or checking a function on the tool

To install the saw blade or scraper blade

1. Loosen and remove the cap screw (a) and large blade washer from the shaft flange using Allen wrench provided. (FIG 1)
2. Place the accessory over the shaft flange (b). The shaft flange of this tool comes with a 4-pin design. Make sure the holes on the accessory properly engage those 4 pins and the accessory is flush against the shaft flange.
3. Put the cap screw and washer back on. Make sure the concave side of the large blade washer is facing the accessory. Tighten the cap screw securely using Allen wrench (c) provided. (See FIG 1)

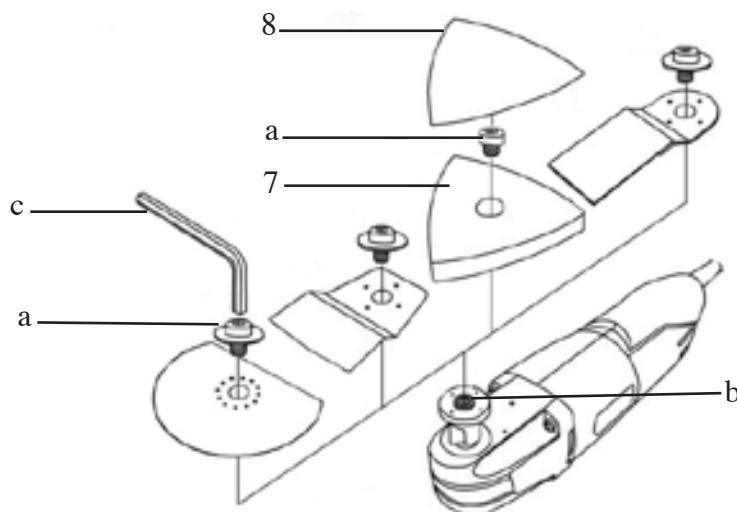

FIG 1

NOTE: Some accessories, such as a saw blade, may be mounted either straight on the tool, or at an angle to enhance usability. Always make sure the 4 pins are engaged as in step 2 above.

To install the Sanding pad and Sandpaper

1. Loosen and remove the cap screw (a), and large blade washer from the shaft flange.
2. Place hook & loop sanding pad (7) against the shaft flange (b), make sure to position it with one tip facing straight forward. Make sure that the 4 pins on the shaft flange fully engage the sanding pad, and that the pad is flush against the shaft flange. (See FIG 1).
3. Put only the cap screw back on (without washers). Tighten it to secure the sanding pad on shaft flange.
4. Align the sandpaper (8) and press it onto the sanding pad by hand. Turn the tool over, and firmly press the sandpaper against a flat surface to secure the hook and loop paper. (See FIG 1)

NOTE: For maximum sandpaper life, rotate the pad or sandpaper 120 degrees when tip of sandpaper becomes worn.

⚠ WARNING: DO NOT tighten the cap screw unless the accessory is properly seated on the shaft flange.

To remove accessories from the tool, simply just reverse the above procedures.

OPERATION

⚠ WARNING: Always be sure the tool is disconnected from the power source before making any adjustments or setting up prior to cutting. Failure to disconnect or unplug the tool may cause accidental starting, resulting in serious personal injury.

STARTING AND STOPPING THE OSCILLATING TOOL

To start the oscillating tool, slide the ON/OFF switch forward to ON position. (FIG 2)

To stop the oscillating tool, slide the ON/OFF switch backward to OFF position. (FIG 2)

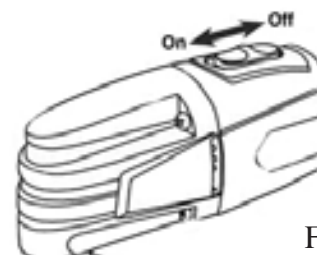

FIG 2

APPLICATIONS

NOTE: This tool must be used only with GENESIS oscillating tool accessories. See Accessories Chart for details.

This multi-purpose oscillating tool is intended for cutting and sanding wood, plastic, plaster and non-ferrous metals. It is especially suitable for cutting in tight spaces and for flush cutting. Following are a few typical uses.

Cutting:

Use a flush cutting saw blade (or “e-cut blade”) for making precise cuts in tight areas, close to edges or flush to a surface. It is important not to force the tool during the flush cutting. If you are experiencing a strong vibration in your hand during the plunge cut, it indicates too much pressure on the tool. Back off on the pressure and let the speed of tool do the work. See FIG 3, FIG 4 for typical uses of flush cutting saw blade.

NOTE: It is suggested that you have a piece of scrap material supporting the blade when making a flush cut. If you need to rest the blade on a delicate surface, you need to use cardboard or masking tape to protect the surface.



FIG 3



FIG 4



FIG 5

Use the half-round flat saw blade (5) for making precise cuts in wood, plaster or drywall material. Applications include cutting openings for electrical boxes, repairing flooring, cutting flooring for venting, and more. See FIG 5 for use of flat saw blade.

Sanding

With sanding accessories, this tool is a detail sander. It is suitable for dry sanding of wood, plastic, and metal surfaces, especially in corners, edges and hard to reach areas. See FIG 6

Tips:

1. Work with the complete surface of the sandpaper, not only with the tip.
2. Sand with continuous motion and light pressure. Do not apply excessive pressure. Let tool do the work.
3. Always secure small work pieces.
4. Select suitable abrasive paper for best results.



FIG 6

Scraping

Scraper blades are suitable for removing vinyl, varnish, paint layers, carpeting, caulk and other adhesives.

Use a rigid scraper blade to remove harder materials, such as vinyl flooring, carpeting and tile adhesives in large area.

Use a flexible scraper blade (not included) to remove softer material such as caulk. See FIG 7

Tips:

1. When removing strong, tacky adhesive, grease the scraper blade surface to reduce gumming up.
2. Begin with light pressure. The oscillating motion of accessory only occurs when pressure is applied to the material to be removed.
3. If you are removing caulk from a delicate surface, such as a bath tub or tile back splash, we recommend taping to protect the surface that blade will rest on.



FIG 7

Grout Removal

Use a grout removal blade (not included) to remove damaged or cracked grout, or in order to replace a damaged or broken tile.







To remove the grout, use a back and forth motion, making several passes along the grout line. Be careful not to apply too much side pressure on the grout blade. See FIG 8



FIG 8

ACCESSORIES

NOTE: This tool must be used only with GENESIS oscillating tool accessories.

Model	Picture	Description	Recommended Application
GAMT301		Flush Cut Saw Blade Assortment Pack, Size: 3/8" (10mm), Size: 3/4" (20mm), Size: 1-3/16" (30mm)	Cutting and flush cuts in Wood, Plastic, Drywall and other soft materials. For example: -Flush cutting door jamb or base molding. -Cut-outs in furniture for cable connections.
GAMT302		3" Wood & Drywall Saw Blade (HSS)	Cutting in Wood, Plastic, Drywall and other Soft Materials. For example -Cutting opening in flooring for venting -Cutting opening for electrical boxes
GAMT303		1/8" Grout Removal Blade	For removing grout from floor or wall tiles for replacement or restoration.
GAMT304		Scraper Blade Twin pack: Rigid Scraper Blade(Left) Flexible Scraper Blade(Right)	-Rigid Scraper Blade to remove vinyl flooring and bonded carpeting, old coats of varnish/paint and other adhesives. -Flexible Scraper Blade to remove caulk, coats of peeling paint or soft adhesives.
GAMT305		Sandpaper Assortment Pack (3) 60 grit, (3) 80 grit, (3) 120 grit, (3) 240 grit	For detail sanding.
GAMT306		Bi-Metal Flush Cut Saw Blade for Metal and Wood, 1-3/8" (35mm)	Cutting or flush cuts in non-ferrous metals, wood, plastic, drywall and other soft materials. For example: -Cutting copper pipe -Cable ducts flush against walls, floors or ceilings

MAINTENANCE

CLEANING

Avoid using solvents when cleaning plastic parts. Most plastics are susceptible to damage from various types of commercial solvents and may be damaged by their use. Use clean cloths to remove dirt, dust, oil, grease, etc.

⚠ WARNING: Do not at any time let brake fluids, gasoline, petroleum-based products, penetrating oils, etc., come in contact with plastic parts. Chemicals can damage, weaken or destroy plastic which may result in serious personal injury.

Electric tools used on fiberglass material, wallboard, spackling compounds, or plaster are subject to accelerated wear and possible premature failure because the fiberglass chips and grindings are highly abrasive to bearings, brushes, commutators, etc. Consequently, we do not recommend using this tool for extended work on these types of materials. However, if you do work with any of these materials, it is extremely important to clean the tool using compressed air.

LUBRICATION

This tool is permanently lubricated at the factory and requires no additional lubrication.

TWO-YEAR WARRANTY

This product is warranted free from defects in material and workmanship for 2 years after date of purchase. This limited warranty does not cover normal wear and tear or damage from neglect or accident. The original purchaser is covered by this warranty and it is not transferable. Prior to return your tool to store location of purchase, please call Toll-Free Help Line for possible solutions. ***THIS PRODUCT IS NOT WARRANTED IF USED FOR INDUSTRIAL OR COMMERCIAL PURPOSES.***

TOLL-FREE HELP LINE

For questions about this or any other GENESIS Product, please call Toll-Free: **888-552-8665**.

Or visit our website: **www.richpowerinc.com**

Genesis