

4-SLICE TOASTER



Model Number:
169115
UPC: 681131691154

Customer Assistance
1 877 207 0923 (US)
1 877 556 0973 (Canada)



Thank you for purchasing a small GE appliance.
In keeping with the GE ecomagination initiative, please consider the option to recycle the packaging material and donate the appliance you are no longer using.

To read more about GE's ecomagination commitment, visit:
ge.ecomagination.com

IMPORTANT SAFEGUARDS

When using electrical appliances, basic safety precautions should always be followed to prevent the risk of fire, electric shock, burns, or other injuries or damages.

- **Read all instructions before use.**
- Do not touch hot surfaces. Use handles or knobs.
- To protect against electrical shock do not immerse cord or plug in water or other liquids.
- Close supervision is necessary when any appliance is used by or near children.
- Unplug from outlet when not in use and before cleaning. Allow it to cool before putting on or taking off parts.
- Do not operate appliance with a damaged cord or plug, or after the appliance malfunctions or has been dropped or damaged in any manner. Call our toll-free customer assistance number for information on examination, repair, or adjustment.
- The use of accessory attachments not recommended by the appliance manufacturer may cause injuries.
- Do not use outdoors.
- Do not let cord hang over edge of table or counter, or touch hot surfaces.
- Do not place on or near a hot gas or electric burner, or in a heated oven.
- To disconnect, turn every control to "off", then remove plug from the wall outlet.
- Do not use this appliance for anything other than its intended use.
- Oversized foods, metal foil packages, or utensils must not be inserted in the toaster as they may cause a risk of fire or electric shock.
- A fire may occur if the toaster is covered or touching flammable material, including curtains, draperies, walls, etc., when in operation.
- Do not attempt to dislodge food when toaster is plugged in.
- Do not operate toaster unattended.
- Risk of fire if the crumb tray is not cleaned regularly.
- Do not use metal scouring pads for cleaning. Pieces can get broken, and there is a risk of electric shock if the pad comes in contact with electrical parts.
- Do not cook, warm or toast rice cakes, fried foods, or non-bread items.

SAVE THESE INSTRUCTIONS!

ADDITIONAL SAFEGUARDS

This appliance is for **HOUSEHOLD USE ONLY**.

DO NOT OPERATE APPLIANCE IF THE LINE CORD SHOWS ANY DAMAGE OR IF APPLIANCE WORKS INTERMITTENTLY OR STOPS WORKING ENTIRELY.

EXTENSION CORDS

A short power-supply cord is to be provided to reduce the risk resulting from becoming entangled in or tripping over a longer cord. Longer detachable power-supply cords or extension cords are available and may be used if care is exercised in their use. If a longer detachable power-supply cord or extension cord is used,

- 1) The marked electrical rating of the cord set or extension cord should be at least as great as the electrical rating of the appliance, and
- 2) The cord should be arranged so that it will not drape over the countertop or tabletop where it can be pulled on by children or tripped over unintentionally.

GROUNDING INSTRUCTIONS

This appliance must be grounded while in use.

CAUTION: To ensure continued protection against risk of electric shock, connect to properly ground outlets only.

GROUNDING INSTRUCTIONS – US ONLY

The appliance has a plug that looks like Figure A. An adaptor, as shown in Figure B, should be used for connecting a 3-prong grounding plug to a 2-wire receptacle. The grounding tab, which extends from the adaptor, must be connected to a permanent ground such as a properly grounded receptacle as shown in Figure C, using a metal screw.

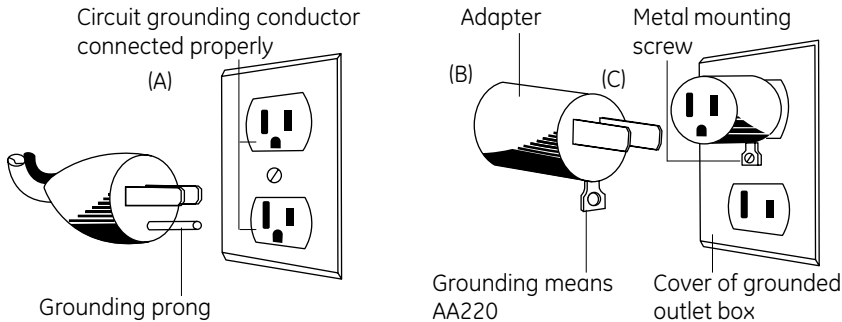

PARTS

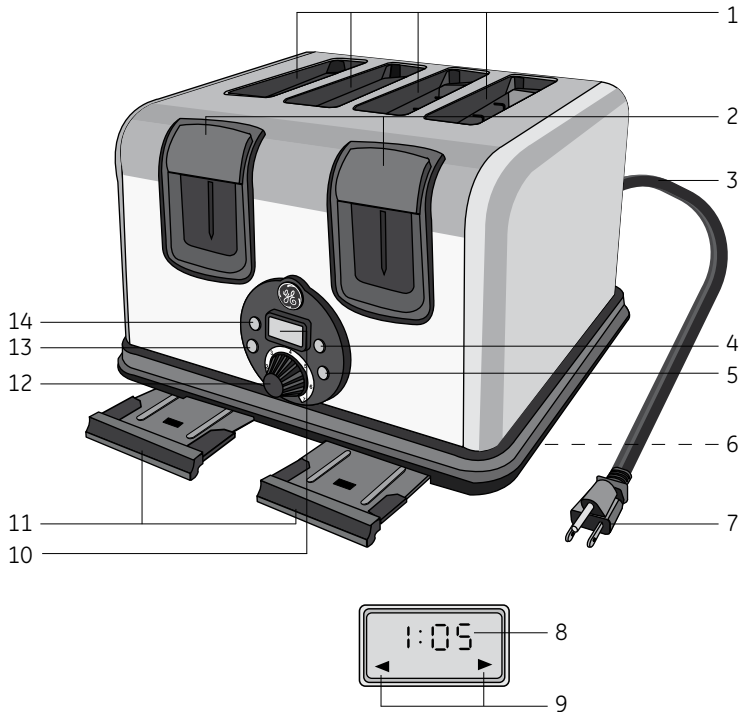

- | | |
|----------------------------------|---|
| 1. Slots with self-center guides | 9. Slot pair indicator
◀ left slot pair in use
▶ right slot pair in use |
| 2. Levers with lift function | 10. Digital display |
| 3. Power cord | 11. Crumb trays |
| 4. Reheat button | 12. Electronic browning control knob |
| 5. Defrost button | 13. Bagel button |
| 6. Cord storage | 14. Cancel button |
| 7. Power plug | |
| 8. Countdown timer | |

NOTE: This toaster contains two independently operating toasting units. Each unit consists of two toasting slots. Both units are controlled through one single display and one single set of operation buttons.

ILLUSTRATIONS

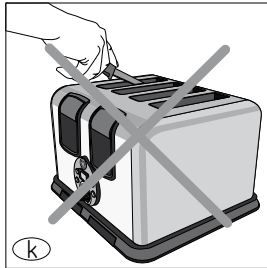
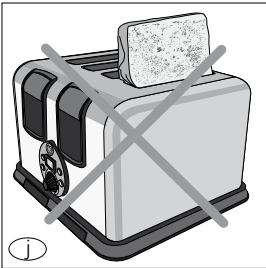
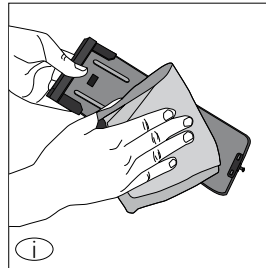
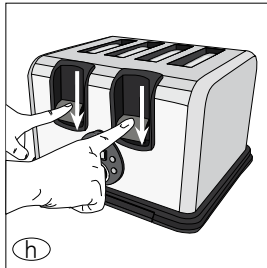
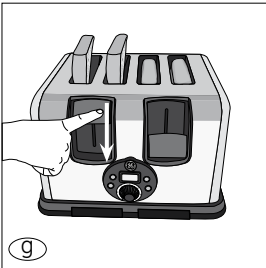
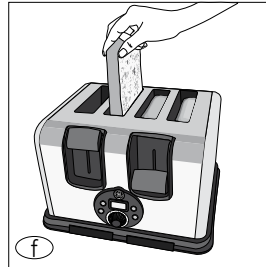
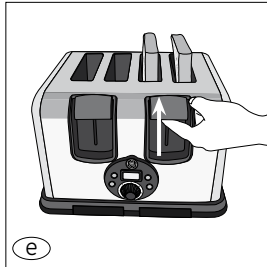
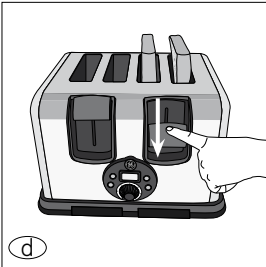
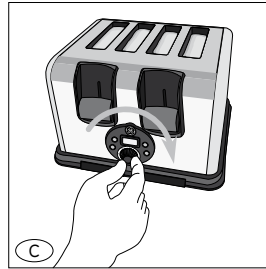
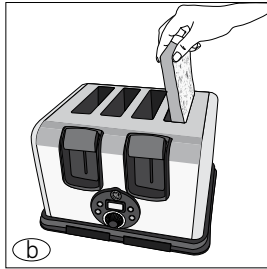
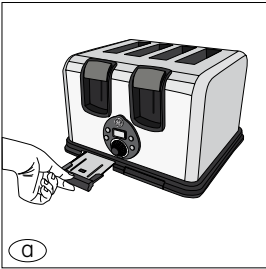

OPERATION

Before first use



- Remove all packaging material, labels, and/or stickers from your toaster. Make sure there is no packaging material remaining in the toasting slots.
- Clean the toaster thoroughly before its first use (↳ *Cleaning*).

NOTE: Due to the manufacturing process, the toaster may emit a slight burning odor. Let the toaster complete a few toasting cycles without food, until no odor or smoke is present. Note: use the toaster in a well ventilated area and select **7** as the highest setting.

Operating instructions

- Make sure no food or other objects are inside the slots **(1)**. Place the toaster on a flat, level, and heat-resistant surface.
- Make sure the crumb trays **(11)** are inserted properly (*ill.* **(a)**).
- Insert the plug **(7)** into a 120 V ~60Hz AC wall outlet.
- Remove any protective wrappings from foods before placing them in the slots **(1)**. Do not toast torn food. They may become lodged in the slots **(1)** (*ill.* **(j)**).
- Insert the food in one of the slot pairs **(1)** (*ill.* **(b)**). Select the desired browning setting with the browning control knob **(12)** (*ill.* **(c)**). Choose between browning setting **1** and **2** according to your preference. Use settings **3** to **7** only to toast frozen food or for the bagel settings.

Food	Knob position
Food, toasts	1 to 2
Frozen waffles	3 to 4
Bagels	5 to 7
English muffins	5 to 7
Frozen food or toasts	6 to 7

- Press down the lever **(2)** until it is locked (*ill.* **(d)**). The toasting process begins. The digital display **(10)** will light up and show the countdown timer **(8)** and ◀ or ▶ **(9)** to indicate if the left or the right slot pair is in use.
- The toast will pop up when the timer reaches **0:00**.
- During the toasting cycle, the  **Cancel** button **(14)** is illuminated. To stop or interrupt a toasting cycle, press the  **Cancel** button **(14)**; the food will pop up and the toaster will turn off.
- This toaster is equipped with an extra food lift to assist in removing food from the slots **(1)**. Pull the lever **(2)** upwards to lift the food higher for ease of removal (*ill.* **(e)**).
- Always unplug the toaster from the wall outlet when it is not in use.

OPERATION

NOTE: The lever (2) will not stay in the down position unless the toaster is connected to an energized wall outlet.



Adding the second slot pair

- While the first slot pair is in use, place food in the second slot pair (1) (ill. (f)).
- Adjust the browning setting for the second slot pair with the browning control knob (12) (ill. (c)).
- Press down the lever (2) until it is locked (ill. (g)).
- The digital display (10) now shows ◀ and ▶ (9), alternating, and the toasting time of the left and right slot pairs.
- The food will pop up after each timer for the left and right slot pairs reaches 0:00.



Simultaneous use of both slot pairs

- Place the food in both slot pairs (1) (ills. (b) and (f)).
- Choose the desired browning setting with the browning control knob (12) (ill. (c)).
- Press down both levers (2) simultaneously until they are locked (ill. (h)).
- The digital display (10) will light up and show the countdown timer (8) with ◀ and ▶ (9) for simultaneous use of both slot pairs.
- The food will pop up simultaneously when the timer reaches 0:00.

Reheat







- Place food in the slot(s) (1) (ill. (b)).
- Press down the lever (2) until it is locked (ill. (d)).
- Press the  Reheat button (4) within the next 5 seconds. The  Reheat button (4) lights up. The reheating time of 1 minute is shown in the display (10). The symbols ◀ or ▶ (9) will appear to indicate which slot pair is in use.
- The food will pop up when the timer reaches 0:00.

Defrost

















- Place the frozen food in one of the two slot pairs (1) (ill. (b)).
- Select the browning level with the browning control knob (12) (ill. (c)).
- Press down the lever (2) until it is locked (ill. (d)).
- Press the  Defrost button (5) within the next 5 seconds. The  Defrost button (5) lights up. The countdown timer (8) will appear together with ◀ or ▶ (9) to indicate the slot pair in use.
- The food will pop up when the timer reaches 0:00.

OPERATION







Toasting bagels and English muffins

- Cut the bagels or English muffins in half. Do not force bagel or English muffin into slots. It may be necessary to cut food in slices to fit in comfortably (ill. ). Place the bagel or the English muffin in the one of the slot pairs **(1)** (ill. ) and turn the cut sides of the bagel or the English muffin towards the middle of the slot pair to achieve a better result.
- Select the browning level with the browning control knob **(12)** (ill. ).
- Press the  **Bagel** button **(13)** within the next 5 seconds. The  **Bagel** button **(13)** lights up. The countdown timer **(8)** will appear together with  or  **(9)** to indicate the slot pair in use. The bagel setting uses less power to protect the bagel from burning.
- The bagels will pop up when the timer reaches 0:00.
- To use both slot pairs **(1)** to toast bagels or English muffins in sequence or simultaneously, refer to *Adding the second slot pair* and *Simultaneous use of both slot pairs*.





Running two programs simultaneously

- Place the food in the first slot pair **(1)** (ill. ).
- Select the browning level with the browning control knob **(12)** (ill. ).
- Press down the lever of the first slot pair **(2)** until it is locked (ill. ).
- Press the desired program button ( **Reheat (4)**,  **Defrost (5)**,  **Bagel (13)**) within 5 seconds. The button will light up. The digital display shows the countdown timer **(8)** together with  or  **(9)** to indicate the slot pair in use.
- Place food in the second slot pair (ill. ).
- Select the browning level with the browning control knob **(12)** (ill. ).
- Press down the lever of the second slot pair **(2)** until it is locked (ill. ).
- Press the desired program button ( **Reheat (4)**,  **Defrost (5)**,  **Bagel (13)**) within 5 seconds. The button will light up. The digital display shows the countdown timer **(8)** together with  or  **(9)** to indicate the slot pair in use.
- The food will pop up after the timer for each slot pair reaches 0:00.

Combining programs

It is possible to combine the  **Bagel** button **(13)** with the  **Defrost** and  **Reheat** functions. If the  **Bagel** button is pressed before or after the  **Reheat** or  **Defrost** button, the toaster will operate on lower power setting.

OPERATION

	Reheat	Defrost
Bagel	<ul style="list-style-type: none"> • Press  Bagel (13) and  Reheat (4) buttons. Both buttons will light up. • Reheat will start with low power setting. Fixed time of 1 minute. 	<ul style="list-style-type: none"> • Adjust the browning level with the browning control knob (12) (<i>ill. (C)</i>). • Press  Bagel (13) and  Defrost (5). Both buttons will light up.

NOTE: Both buttons must be pressed within 5 seconds after the lever is locked in down position.



CAUTION: Before cleaning and storing, unplug the toaster to prevent electric shock and let the toaster cool down completely.

CLEANING

Clean the toaster regularly. This appliance contains no user serviceable parts and requires little maintenance. Leave any servicing or repairs to qualified personnel.

- Never immerse the toaster and the power cord **(3)** in water or any other liquid.
- Do not use a fork or other metallic utensils to remove lodged food as this may result in electric shock or fire (*ill. (K)*).
- For cleaning the outside of the toaster and the cord **(3)**, use a soft cloth or a damp sponge and a mild detergent. Do not use any abrasive cleaning agents, metallic utensils, metal scouring pads, etc.
- To clean the crumb trays **(11)**, first push the trays in, then pull them out completely and throw crumbs away. Rinse the crumb trays with water and a little detergent, and dry them with a soft cloth (*ill. (I)*). Reinsert the crumb trays **(11)** (*ill. (A)*) carefully.
- Do not wrap the cord around the toaster (*ill. (D)*). Store the cord in the cord storage **(6)** underneath the toaster.

TROUBLESHOOTING

Problem	Solution
Toaster is not working.	Check power connection. The plug (7) should be inserted properly in the outlet.
Food stuck in the toaster.	Unplug the toaster and let cool. Carefully remove the slice(s) from the toaster.
Toast too dark or too light.	The selected browning setting is too high or too low.
Toaster emits smoke.	The selected browning setting is too high for the type of food that is being toasted. Press the  Cancel button (14) to stop the toasting cycle.
Food ejects very quickly.	Push down the lever (2) completely (ills.  and ).

If additional assistance is needed, please contact our Customer Assistance at 1.877.207.0923 (U.S.) or 1.877.556.0973 (Canada).

TECHNICAL DATA

Rated voltage:	120V ~60Hz
Rated current:	13A
Rated power input:	1600W

CUSTOMER ASSISTANCE

If you have a claim under this warranty, please call our Customer Assistance Number. For faster service, please have the model number and product name ready for the operator to assist you. This number can be found on the bottom of your appliance and on the front page of this manual.

Model Number: _____ **Product Name:** _____

Customer Assistance Number 1.877.207.0923 (U.S.) or 1.877.556.0973 (Canada).

Keep these numbers for future reference!

For more information, please visit us at WWW.GEHOUSEWARES.COM

Two-year limited warranty

What does your warranty cover?

- Any defect in material or workmanship.

For how long after the original purchase?

- Two years.

What will we do?

- Provide you with a new one.
- For those items still under warranty but no longer available, WAL-MART reserves the right to replace with a similar GE branded product of equal or greater value.

How do you make a warranty claim?

- Save your receipt.
- Properly pack your unit. We recommend using the original carton and packing materials.
- Return the product to your nearest WAL-MART store or call Customer Assistance at 1-877-207-0923 (U.S.) or 1-877-556-0973 (Canada).

What does your warranty not cover?

- Parts subject to wear, including, without limitation, glass parts, glass containers, cutter/strainer, blades, seals, gaskets, clutches, motor brushes, and/or agitators, etc.
- Commercial use or any other use not found in printed directions.
- Damage from misuse, abuse, or neglect, including failure to clean product regularly in accordance with manufacturer's instructions.

How does state law relate to this warranty?

- This warranty gives you specific legal rights, and you may also have other rights which vary from state to state or province to province.
- This warranty is in lieu of any other warranty or condition, whether express or implied, written or oral, including, without limitation, any statutory warranty or condition of merchantability or fitness for a particular purpose.
- WAL-MART, GE and the product manufacturer expressly disclaim all responsibility for special, incidental, and consequential damages or losses caused by use of this appliance. Any liability is expressly limited to an amount equal to the purchase price paid whether a claim, however instituted, is based on contract, indemnity, warranty, tort (including negligence), strict liability, or otherwise. Some states or provinces do not allow this exclusion or limitation of incidental or consequential losses, so the foregoing disclaimer may not apply to you.

What if you encounter a problem with this product while using it outside the country of purchase?

- The warranty is valid only in the country of purchase and if you follow the warranty claim procedure as noted.



is a trademark of General Electric Company and is used under the license by Wal-Mart Stores Inc., Bentonville, AR 72716

Marketed in Canada by:

Wal-Mart Canada Corp.
1940 Argentia Road, Mississauga,
Ontario L5N1P9