

# FURUNO

## OPERATOR'S MANUAL

MODEL 1823C MARINE RADAR  
MODEL 1833C MARINE RADAR  
MODEL 1933C MARINE RADAR  
MODEL 1943C MARINE RADAR  
MODEL 1953C MARINE RADAR  
COLOR VIDEO PLOTTER GD-1900C

---

***NAVnet***



**FURUNO ELECTRIC CO., LTD.**  
NISHINOMIYA, JAPAN

© **FURUNO ELECTRIC CO., LTD.**

9-52 Ashihara-cho,  
Nishinomiya, Japan

Telephone : 0798-65-2111

Telefax : 0798-65-4200

Your Local Agent/Dealer

All rights reserved.

Printed in Japan

PUB.No. OME-35030

( HIMA ) M1800C SER & GD1900C

FIRST EDITION : APR. 2001

G : JAN. 21,2003



\* 0 0 0 8 0 9 1 9 8 0 2 \*



\* O M E 3 5 0 3 0 G 0 0 \*



# SAFETY INSTRUCTIONS



## WARNING



**ELECTRICAL SHOCK HAZARD**  
Do not open the equipment.

Only qualified personnel should work inside the equipment.



**Turn off the radar power switch before servicing the antenna unit. Post a warning sign near the switch indicating it should not be turned on while the antenna unit is being serviced.**

Prevent the potential risk of being struck by the rotating antenna and exposure to RF radiation hazard.



**Wear a safety belt and hard hat when working on the antenna unit.**

Serious injury or death can result if someone falls from the radar antenna mast.

**Do not disassemble or modify the equipment.**

Fire, electrical shock or serious injury can result.

**Turn off the power immediately if water leaks into the equipment or the equipment is emitting smoke or fire.**

Continued use of the equipment can cause fire or electrical shock.

**Use the proper fuse.**

Fuse rating is shown on the power cable. Use of a wrong fuse can result in damage to the equipment.

**Keep heater away from equipment.**

Heat can alter equipment shape and melt the power cord, which can cause fire or electrical shock.



## WARNING

### Radio Frequency Radiation Hazard

The radar antenna emits electromagnetic radio frequency (RF) energy which can be harmful, particularly to your eyes. Never look directly into the antenna aperture from a close distance while the radar is in operation or expose yourself to the transmitting antenna at a close distance.

Distances at which RF radiation levels of 100 and 10 W/m<sup>2</sup> exist are given in the table below.

**Note:** If the antenna unit is installed at a close distance in front of the wheel house, your administration may require halt of transmission within a certain sector of antenna revolution. This is possible - Ask your FURUNO representative or dealer to provide this feature.

MODEL	Distance to 100 W/m <sup>2</sup> point	Distance to 10 W/m <sup>2</sup> point
MODEL 1823C	Nil	Worst case 0.50 m
MODEL 1833C	Nil	Worst case 0.50 m
MODEL 1933C	Worst case 0.20 m	Worst case 3.00 m
MODEL 1943C	Nil	Worst case 2.50 m
MODEL 1953C	XN-12A	Worst case 2.50 m
	XN-13A	Worst case 2.30 m



## CAUTION

**A warning label is attached to the equipment. Do not remove the label. If the label is missing or damaged, contact a FURUNO agent or dealer.**

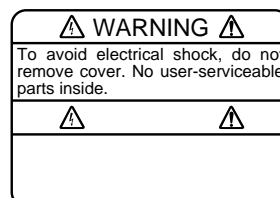

Name: Warning Label (1)  
Type: 86-003-1011-0  
Code No.: 100-236-230

# TABLE OF CONTENTS

---

<b>FOREWORD .....</b>	<b>viii</b>
<b>SYSTEM CONFIGURATIONS .....</b>	<b>x</b>
<b>WHAT IS WAAS?.....</b>	<b>xiii</b>
<b>1. OPERATIONAL OVERVIEW .....</b>	<b>1-1</b>
1.1 Operating Controls .....	1-2
1.1.1 Display unit controls .....	1-2
1.1.2 Remote controller .....	1-4
1.2 Inserting a Chart Card .....	1-5
1.3 Turning the Unit On/Off.....	1-6
1.4 Display Brilliance, Panel Brilliance, Hue .....	1-7
1.4.1 Display brilliance, panel brilliance .....	1-7
1.4.2 Hue .....	1-8
1.5 Selecting a Display .....	1-9
1.5.1 Display modes.....	1-9
1.5.2 Selecting a display .....	1-10
1.5.3 Switching control in combination and overlay screens .....	1-11
1.5.4 Selecting image source .....	1-12
1.6 Trackball, Cursor .....	1-13
1.7 Entering the MOB Mark, Setting MOB as Destination .....	1-14
1.8 Data Boxes.....	1-15
1.8.1 Showing, hiding data boxes with soft key .....	1-15
1.8.2 Rearranging data boxes .....	1-16
1.8.3 Temporarily erasing a data box.....	1-16
1.9 Function Keys.....	1-17
1.9.1 Executing a function .....	1-17
1.10 Simulation Display .....	1-18
<b>2. RADAR OPERATION.....</b>	<b>2-1</b>
2.1 Radar Display .....	2-1
2.2 Transmitting, Stand-by.....	2-2
2.3 Tuning .....	2-2
2.4 Adjusting the Gain .....	2-2
2.5 Reducing Sea Clutter .....	2-4
2.5.1 How the A/C SEA works.....	2-4
2.5.2 Adjusting A/C SEA .....	2-4
2.6 Reducing Precipitation Clutter .....	2-5
2.6.1 Adjusting the A/C RAIN .....	2-5
2.7 Range Scale.....	2-6
2.8 Pulselength.....	2-7

2.9 Presentation Mode.....	2-8
2.9.1 Selecting a presentation mode.....	2-8
2.9.2 Description of presentation modes.....	2-9
2.10 Measuring the Range.....	2-11
2.10.1 Measuring range by range rings.....	2-11
2.10.2 Measuring range by cursor .....	2-12
2.10.3 Measuring range by VRM .....	2-13
2.10.4 Erasing a VRM, VRM indication.....	2-14
2.10.5 Erasing EBL/VRM data boxes.....	2-14
2.10.6 Hiding EBL/VRM data boxes.....	2-14
2.10.7 Moving EBL/VRM data boxes .....	2-14
2.11 Measuring the Bearing .....	2-14
2.11.1 Measuring bearing by cursor .....	2-14
2.11.2 Measuring bearing by EBL .....	2-14
2.11.3 Erasing an EBL, EBL indication.....	2-15
2.11.4 Erasing EBL/VRM data boxes .....	2-15
2.11.5 Hiding EBL/VRM data boxes .....	2-15
2.11.6 Moving EBL/VRM data boxes.....	2-15
2.12 Erasing the Heading Line, North Marker .....	2-16
2.13 Reducing Noise Interference.....	2-16
2.14 Rejecting Radar Interference .....	2-17
2.15 Zoom .....	2-18
2.15.1 Zooming in on radar targets.....	2-18
2.15.2 Zooming in on ARP, TTM targets .....	2-18
2.16 Shifting the Picture.....	2-19
2.16.1 Manual shift .....	2-19
2.16.2 Automatic shift .....	2-20
2.17 Using the Offset EBL.....	2-21
2.17.1 Predicting collision course.....	2-21
2.17.2 Measuring range & bearing between two targets .....	2-22
2.18 Echo Trails .....	2-23
2.18.1 Trail time.....	2-23
2.18.2 Starting echo trails .....	2-24
2.18.3 Trail gradation.....	2-24
2.18.4 Trail color .....	2-25
2.18.5 Echo trail mode.....	2-25
2.19 Echo Stretch .....	2-26
2.20 Echo Averaging.....	2-27
2.21 Outputting TLL Data.....	2-28
2.22 Guard Alarm.....	2-29
2.22.1 Setting a guard alarm zone .....	2-29
2.22.2 When the alarm is violated... ..	2-30
2.22.3 Canceling the guard alarm .....	2-30
2.23 Watchman.....	2-31
2.23.1 How watchman works .....	2-31
2.23.2 Turning on/off watchman.....	2-31
2.23.3 Setting watchman stand-by interval .....	2-31
2.24 Suppressing Second-trace Echoes .....	2-32

2.25	Waypoint Marker.....	2-33
2.26	ARP, TTM Operation.....	2-34
2.26.1	Activating/deactivating ARP, TTM.....	2-35
2.26.2	Acquiring and tracking targets (ARP).....	2-36
2.26.3	Displaying target number (ARP, TTM) .....	2-37
2.26.4	Terminating tracking of ARP targets .....	2-38
2.26.5	Setting vector attributes (ARP) .....	2-39
2.26.6	Displaying past position (ARP) .....	2-40
2.26.7	ARP, TTM target data .....	2-41
2.26.8	CPA/TCPA alarm (ARP) .....	2-42
2.26.9	Lost target alarm (ARP).....	2-43
2.27	Interpreting the Radar Display .....	2-44
2.27.1	General .....	2-44
2.27.2	False echoes.....	2-46
2.27.3	SART (Search and Rescue Transponder) .....	2-48
2.27.4	Racon (Radar Beacon).....	2-50

### **3. PLOTTER OPERATION.....3-1**

3.1	Plotter Displays.....	3-1
3.1.1	Full-screen plotter display.....	3-1
3.1.2	Compass display .....	3-3
3.1.3	Highway display .....	3-5
3.1.4	Nav data display.....	3-6
3.2	Presentation Mode .....	3-7
3.2.1	North-up .....	3-7
3.2.2	Course-up .....	3-8
3.2.3	Auto course-up.....	3-8
3.3	Shifting the Display.....	3-9
3.4	Chart Scale.....	3-9
3.5	Chart Cards .....	3-10
3.5.1	Chart card overview.....	3-10
3.5.2	Indices and chart enlargement .....	3-11
3.5.3	FURUNO and NavCharts™ charts .....	3-12
3.5.4	C-MAP charts.....	3-14
3.6	Working with Track .....	3-18
3.6.1	Displaying track.....	3-18
3.6.2	Stopping, restating plotting of own ship track.....	3-19
3.6.3	Changing track color.....	3-20
3.6.4	Track plotting method and interval for own ship track .....	3-21
3.6.5	Changing own ship track/mark distribution setting .....	3-22
3.6.6	Erasing track .....	3-23
3.7	Marks, Lines .....	3-25
3.7.1	Entering a mark, line.....	3-25
3.7.2	Changing mark attributes .....	3-25
3.7.3	Selecting line type .....	3-26
3.7.4	Erasing marks, lines .....	3-27
3.8	Waypoints.....	3-28
3.8.1	Entering waypoints .....	3-28

3.8.2	Editing waypoint data.....	3-31
3.8.3	Erasing waypoints.....	3-33
3.8.4	Changing waypoint mark size (FURUNO, NavCharts™).....	3-34
3.8.5	Searching waypoints.....	3-35
3.9	Routes.....	3-36
3.9.1	Creating routes.....	3-36
3.9.2	Connecting routes.....	3-40
3.9.3	Inserting waypoints.....	3-41
3.9.4	Removing waypoints from a route.....	3-43
3.9.5	Erasing routes.....	3-43
3.10	Navigation.....	3-44
3.10.1	Navigating to a "quick point".....	3-44
3.10.2	Navigating to waypoints.....	3-45
3.10.3	Navigating to ports, port services (NavCharts™ /C-MAP).....	3-46
3.10.4	Following a route.....	3-48
3.10.5	Canceling route navigation.....	3-51
3.11	Alarms.....	3-52
3.11.1	Audio alarm on/off.....	3-52
3.11.2	Arrival alarm.....	3-53
3.11.3	Anchor watch alarm.....	3-54
3.11.4	XTE (Cross-Track Error) alarm.....	3-55
3.11.5	Speed alarm.....	3-55
3.11.6	Proximity alarm.....	3-56
3.11.7	Trip alarm.....	3-57
3.11.8	Alarm information.....	3-58
3.12	Resetting Trip Distance.....	3-60

#### **4. VIDEO SOUNDER OPERATION ..... 4-1**

4.1	Principle of Operation.....	4-1
4.2	Sounder Displays.....	4-2
4.2.1	Selecting a sounder display.....	4-2
4.2.2	Description of sounder displays.....	4-3
4.2.3	Selecting screen split method in combination displays.....	4-8
4.3	Automatic Sounder Operation.....	4-9
4.3.1	How the automatic sounder works.....	4-9
4.3.2	Types of automatic sounder modes.....	4-9
4.3.3	How to enable automatic sounder operation.....	4-10
4.4	Manual Sounder Operation.....	4-10
4.4.1	Selecting the manual mode.....	4-10
4.4.2	Selecting display range.....	4-10
4.4.3	Adjusting the gain.....	4-10
4.4.4	Shifting the range.....	4-11
4.5	Measuring Depth, Time.....	4-12
4.6	Reducing Interference.....	4-13
4.7	Reducing Low Level Noise.....	4-14
4.8	Erasing Weak Echoes.....	4-15
4.9	White Marker.....	4-16

4.10 Picture Advance Speed .....	4-17
4.10.1 Advancement independent of ship's speed.....	4-17
4.10.2 Advancement synchronized with ship's speed.....	4-18
4.11 Display Colors.....	4-19
4.12 Alarms .....	4-20
4.12.1 Audio alarm on/off .....	4-20
4.12.2 Bottom alarm.....	4-21
4.12.3 Fish alarm .....	4-21
4.12.4 Fish alarm (B/L).....	4-22
4.12.5 Water temperature alarm.....	4-23
4.12.6 When an alarm setting is violated.....	4-24
4.13 Water Temperature Graph .....	4-25
4.14 Changing Pulse Repetition Rate .....	4-26
4.15 Interpreting the Sounder Display .....	4-27
4.15.1 Zero line .....	4-27
4.15.2 Bottom echo .....	4-27
4.15.3 Fish school echoes.....	4-28
4.15.4 Surface noise/Aeration .....	4-28

## **5. CUSTOMIZING YOUR UNIT..... 5-1**

5.1 General Setup .....	5-1
5.2 Radar Setup .....	5-3
5.2.1 Radar display setup.....	5-3
5.2.2 Radar range setup.....	5-6
5.2.3 Function key setup .....	5-7
5.3 Plotter Setup.....	5-9
5.3.1 Navigation options.....	5-9
5.3.2 Function key setup .....	5-10
5.4 Chart Setup .....	5-12
5.4.1 Chart offset.....	5-12
5.4.2 FURUNO, NavCharts™ chart attributes .....	5-13
5.4.3 C-MAP chart attributes .....	5-15
5.5 Data Boxes Setup.....	5-18
5.6 Hot Page Setup .....	5-19
5.7 Navigator Setup.....	5-21
5.7.1 Navigation data source.....	5-21
5.7.2 GPS receiver setup (Set equipped with GP-310B/320B) .....	5-22
5.7.3 TD display setup.....	5-26
5.8 Nav Data Display Setup.....	5-28
5.9 Sounder Setup.....	5-29
5.9.1 System setup.....	5-29
5.9.2 Sensor setup .....	5-31
5.9.3 Sounding range, zoom range, bottom lock range .....	5-32
5.9.4 Function key setup .....	5-33



<b>6. DATA TRANSFER.....</b>	<b>6-1</b>
6.1 Memory Card Operations.....	6-1
6.1.1 Formatting memory cards.....	6-1
6.1.2 Saving data to a memory card.....	6-2
6.1.3 Playing back data from a memory card.....	6-4
6.2 Uploading, Downloading Data.....	6-5
6.2.1 Setting communication software on the PC.....	6-5
6.2.2 Uploading or downloading data.....	6-5
6.3 Loading Waypoint Data from Yeoman.....	6-8
6.4 Receiving Data Via Network Equipment.....	6-9
6.5 Outputting Data Trough the Network.....	6-10
<b>7. MAINTENANCE, TROUBLESHOOTING .....</b>	<b>7-1</b>
7.1 Preventive Maintenance.....	7-1
7.2 Replacement of Battery.....	7-1
7.3 Replacement of Fuse.....	7-2
7.4 Trackball Maintenance.....	7-2
7.5 Simple Troubleshooting.....	7-3
7.5.1 General.....	7-3
7.5.2 Radar.....	7-3
7.5.3 Plotter.....	7-4
7.5.4 Sounder.....	7-5
7.6 Diagnostics.....	7-6
7.6.1 Memory I/O test.....	7-6
7.6.2 Test pattern.....	7-9
7.6.3 Keyboard, remote controller test.....	7-10
7.7 GPS Status Display.....	7-11
7.8 Cleaning Memories.....	7-12
7.9 Error Messages.....	7-13
<b>APPENDIX .....</b>	<b>A-1</b>
Menu Overview.....	A-1
Geodetic Chart List.....	A-10
World Time Chart.....	A-11
Icons.....	A-12
<b>SPECIFICATIONS.....</b>	<b>SP-1</b>
<b>INDEX.....</b>	<b>Index-1</b>
<b>Declaration of Conformity</b>	

# FOREWORD

---

## **A Word to the Owner of the Model 1800C/1900C Series Marine Radar, GD-1900C Color Video Plotter**

FURUNO Electric Company thanks you for purchasing the Model 1800C/1900C Series Marine Radar, GD-1900C Color Video Plotter. We are confident you will discover why the FURUNO name has become synonymous with quality and reliability.

For over 50 years FURUNO Electric Company has enjoyed an enviable reputation for quality and reliability throughout the world. This dedication to excellence is furthered by our extensive global network of agents and dealers.

Your equipment is designed and constructed to meet the rigorous demands of the marine environment. However, no machine can perform its intended function unless properly installed and maintained. Please carefully read and follow the operation and maintenance procedures set forth in this manual.

We would appreciate feedback from you, the end-user, about whether we are achieving our purposes.

Thank you for considering and purchasing FURUNO.

*The example screens shown in this manual may not match the screens you see on your display. The screen you see depends on your system configuration and equipment settings.*

# Features

The 1800C/1900C series of radars and video plotters work within our new product-network system called the “NavNet.” Each product has an IP address to communicate with NavNet compatible products within the network, using TCP/IP protocol through an Ethernet 10BASE-T network.

The main features are as follows:

- The 1800C/1900C series of radars and video plotters consists of the following models:

Model	Output	Range	Radar Antenna
Marine Radar Model 1823C	2.2 kW	24 rpm	1.5 ft, Radome
Marine Radar Model 1833C	4 kW	36 nm	2 ft, Radome
Marine Radar Model 1933C	4 kW	48 nm	3.5 ft, Open
Marine Radar Model 1943C	6 kW	64 nm	4 ft, Open
Marine Radar Model 1953C	12 kW	72 nm	4/6 ft, Open
Color Video Plotter GD-1900C	—	—	—

- Bright 10.4” screen visible even under direct sunlight.
- User friendly operation with combination of discrete keys, soft keys, alphanumeric keys and trackball.
- Accepts FURUNO and Nav-charts™ (NAVIONICS) charts, or C-MAP NT/NT+ charts (C-MAP), depending on specification.

All names mentioned above are registered trademarks of their respective companies.

- Fast chart redraw.
- Built-in NavNet interface circuit board.
- Video input (video recorder, CCD device, etc.) available with installation of optional PIP Board.
- 12-channel GPS Receiver GP-310B with highly accurate position fixing optionally available, GP-320B with WAAS capability.
- User programmable function keys.
- Video sounder picture available with connection of the optional Network Sounder ETR-6/10N or ETR-30N.
- Connected the optional facsimile receiver FAX-30 receives facsimile pictures and navtex messages transmitted from facsimile and navtex stations.

# SYSTEM CONFIGURATIONS

All NavNet products incorporate a “network circuit board” to integrate each NavNet product on board through an optional LAN cable (Ethernet 10BASE-T). Each NavNet product is assigned an IP address to enable transfer of images between other NavNet products. For example, video plotter pictures can be transferred to a radar and vice versa. Pictures received via the NavNet may be adjusted at the receiving end.

The number of display units which may be installed depends on the number of network sounder connected. For a system incorporating three or more products, a “hub” is required to process data.

For one network sounder: one radar and three plotters, or four plotters

For two network sounder: one radar and two plotters, or four plotters

## NavNet system (Model 1823C/1833C/1933C/1943C/1953C)

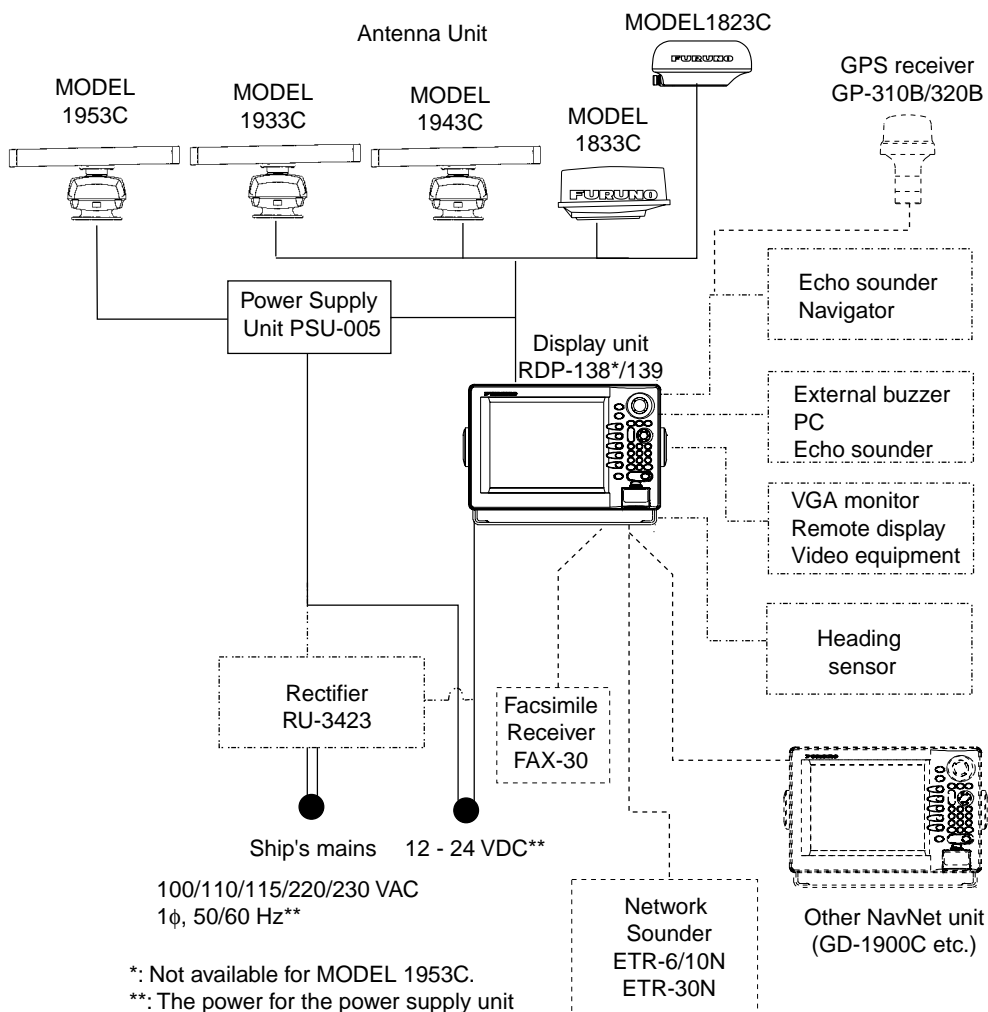

\*: Not available for MODEL 1953C.

\*\*: The power for the power supply unit and display unit must be drawn from the same power source.

## *NavNet system (Model 1823C/1833C/1933C/1943C/1953C)*

**Single-unit NavNet system (GD-1900C)**

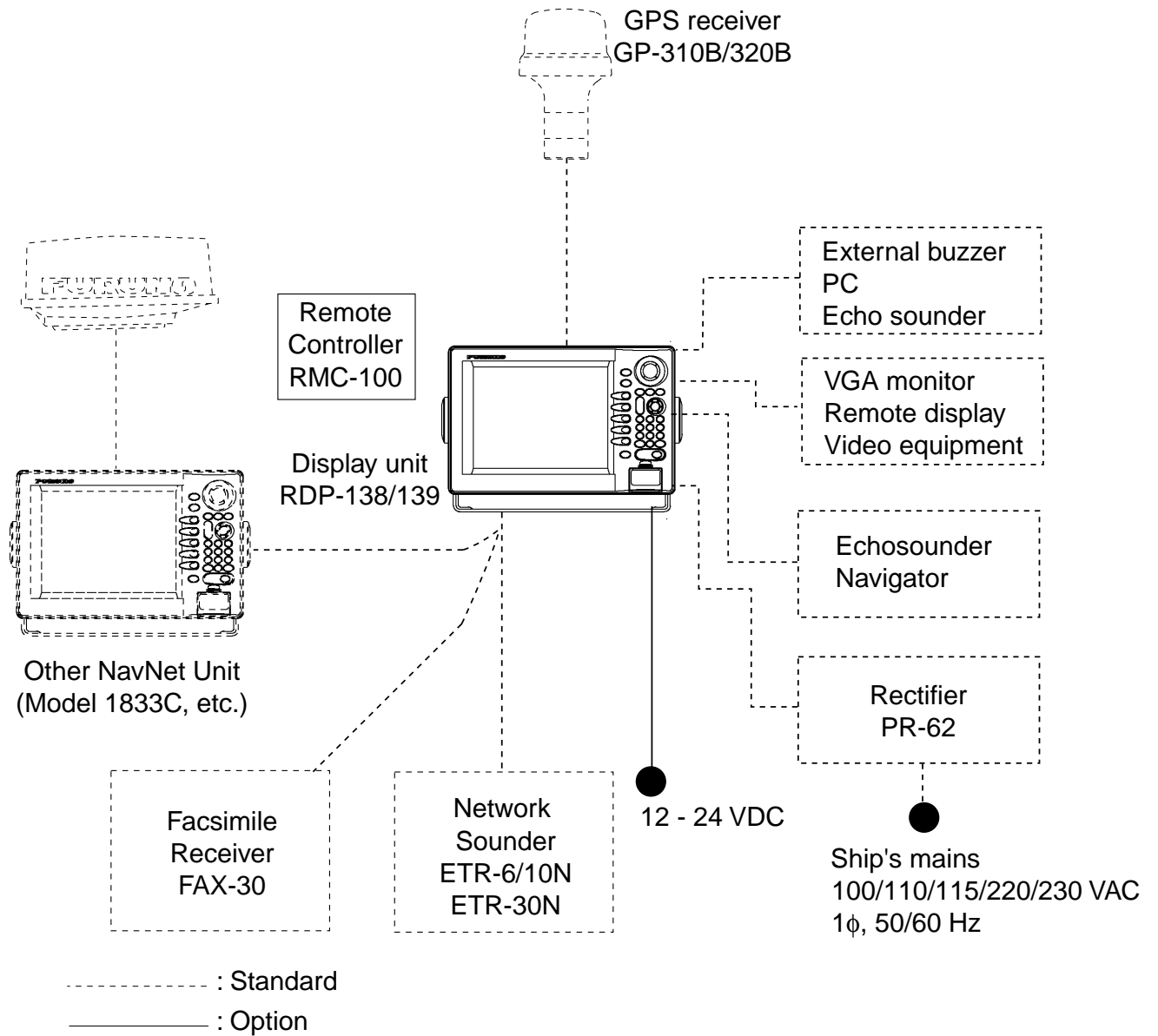

*Single-unit NavNet system (GD-1900C)*

**Two-unit NavNet system**

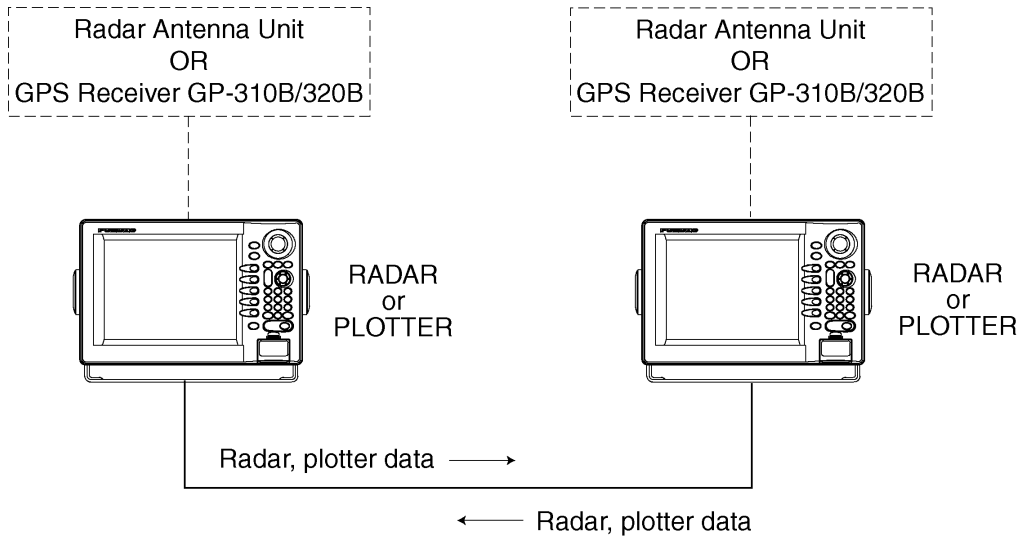

*Two-unit NavNet system*

**Three-or-more-unit NavNet system (Max. 4 display unit and one network sounder capable display units)**

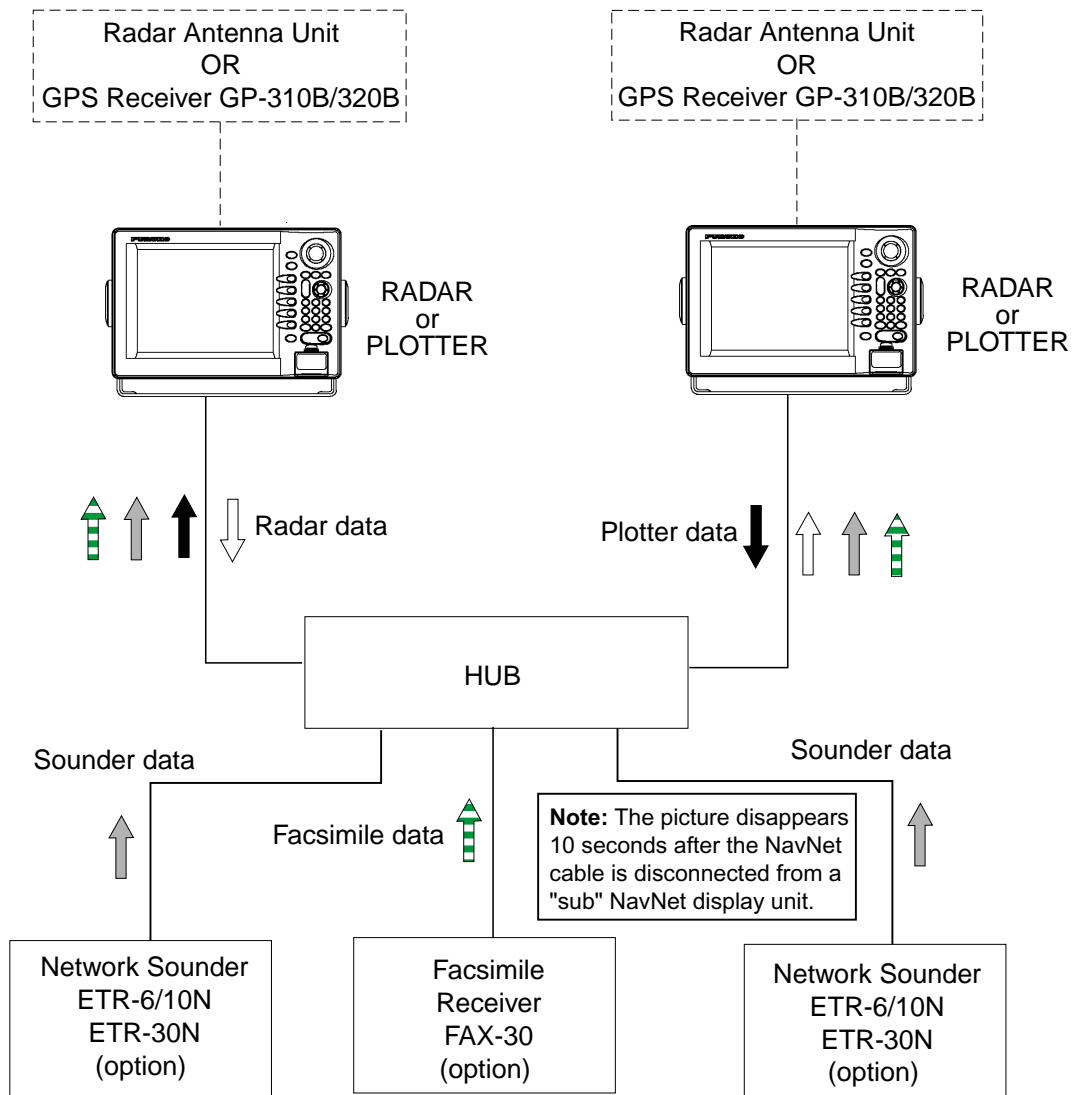

*Three-or-more-unit NavNet system*

# WHAT IS WAAS?

WAAS, available in North America, is a provider in the worldwide SBAS (Satellite Based Augmentation System) navigation system. SBAS provides GPS signal corrections to SBAS users, for even better position accuracy, typically better than three meters. Two more SBAS providers are also currently under development, MSAS (Multi-Functional Satellite Augmentation System) for Japan and EGNOS (Euro Geostationary Navigation Overlay Service) for Europe. All providers will be compatible with one another, thus providing “seamless” position fixes to SBAS users.

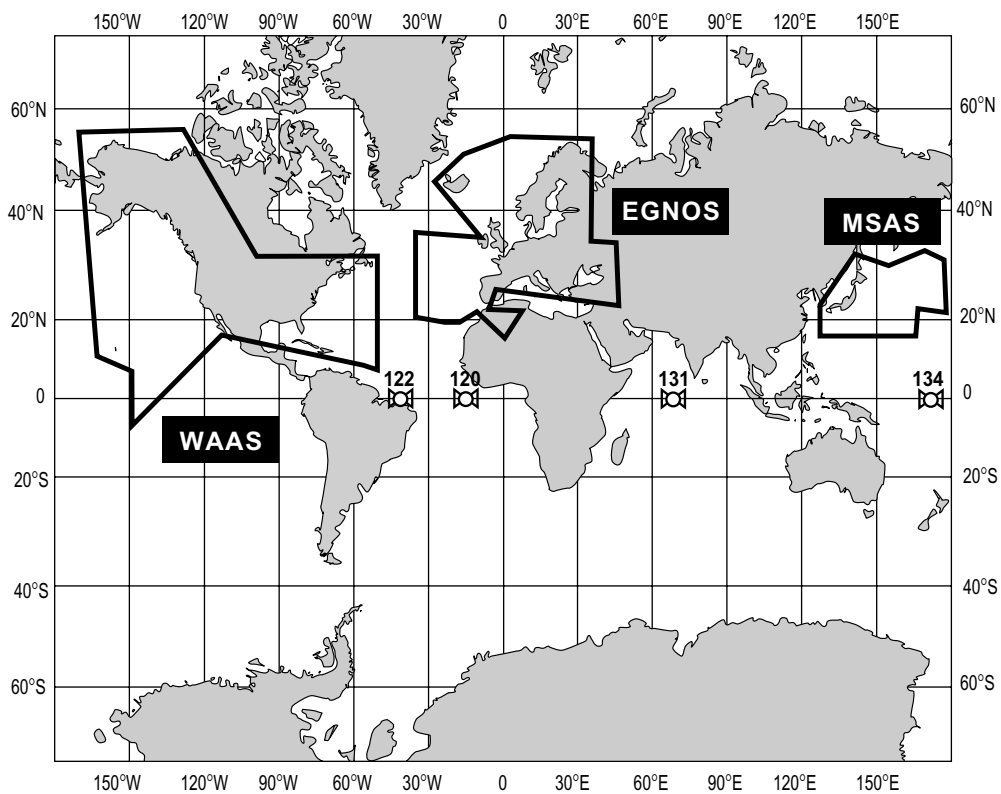

Satellite, Region	Position
120, AOR-E	15.5°W
122, AOR-W	54°W
131, IOR	64.5°E
134, POR	178°E

Initial operation time
WAAS: 2003
EGNOS: 2004
MSAS: 2005

At the time of this software release, SBAS is still under development (Providers are expected to have initial operations capability from the times shown above.) During this developmental period, which may last for several years, there is no guarantee of the accuracy, integrity, continuity, or availability of the SBAS signal. Furuno will accept no responsibility for the use of the signal for other than the above stated purpose. It is the user’s responsibility to exercise common prudence and navigational judgment while using the SBAS signal.

**Note:** This manual uses “WAAS” when referring to any SBAS provider.

This page is intentionally left blank.



# 1. OPERATIONAL OVERVIEW

---

This chapter provides the basic information needed to get you started using your radar, video plotter. The following topics are presented:

- Control overview
- Chart card insertion
- Power on/off
- Brilliance and hue adjustments
- Display selection
- MOB (Man OverBoard) mark entry
- Data boxes
- Function keys
- Simulation display

## **NOTICE**

**The brilliance of the LCD is adjustable to match a wide variety of lighting conditions. However, its maximum setting may not be sufficiently bright to permit viewing of the display with polarized sunglasses.**

**The high-resolution model may show afterglow after several hours of continuous use in the same mode. This is not a sign of malfunction.**

# 1.1 Operating Controls

## 1.1.1 Display unit controls

### Overview of display unit controls

The radar, video plotter, sounder and chart systems are operated with the controls of the display unit (and the remote controller). Ten keys are labeled and they provide the function shown on their labels. The five soft keys provide various functions according to current operating mode. The [ENTER] knob mainly functions to register selections on the menu and adjust the EBL, VRM and gain. The trackball's main function is to move the cursor across the screen. When you correctly execute an operation, the unit generates a beep. Invalid operation causes the unit to emit three beeps.

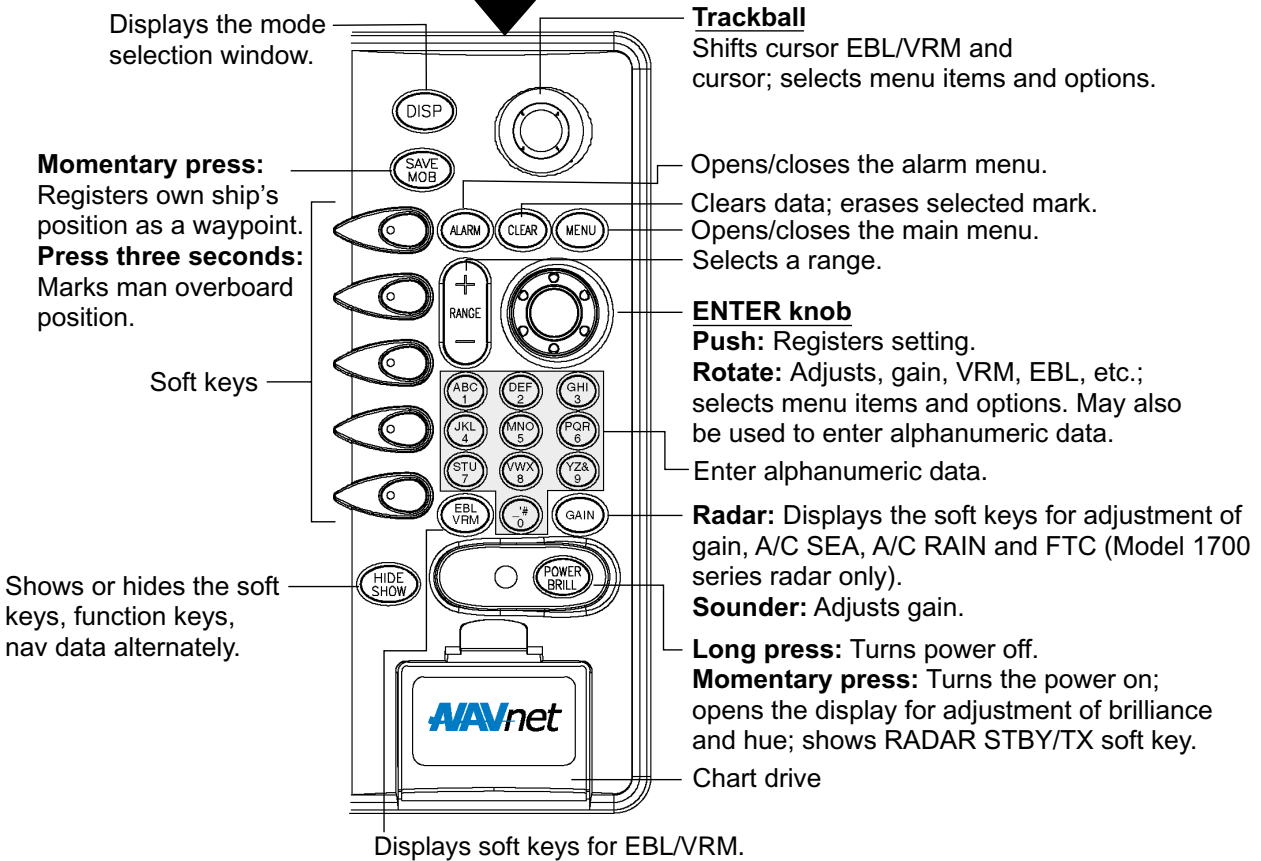
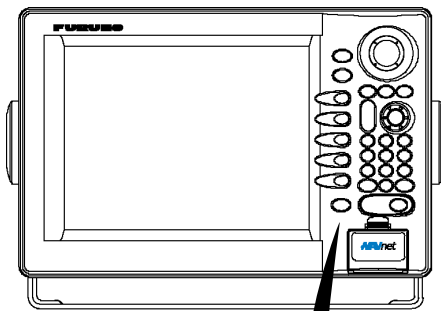

*Control panel*

**Soft keys**

The function of the five soft keys changes according to the operation. Their labels for their current functions are shown on the screen to the left of the keys. To hide or show the soft keys, press the [HIDE/SHOW] key. Each press of the key shows preset soft keys, user function keys or turns off navigation information (at the top of the screen).

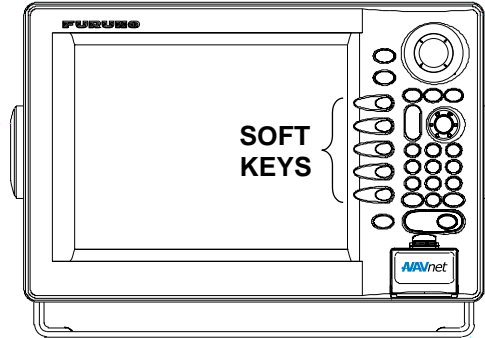

*Display unit*

Some soft keys show the current station of the soft key function in reverse video as shown below.

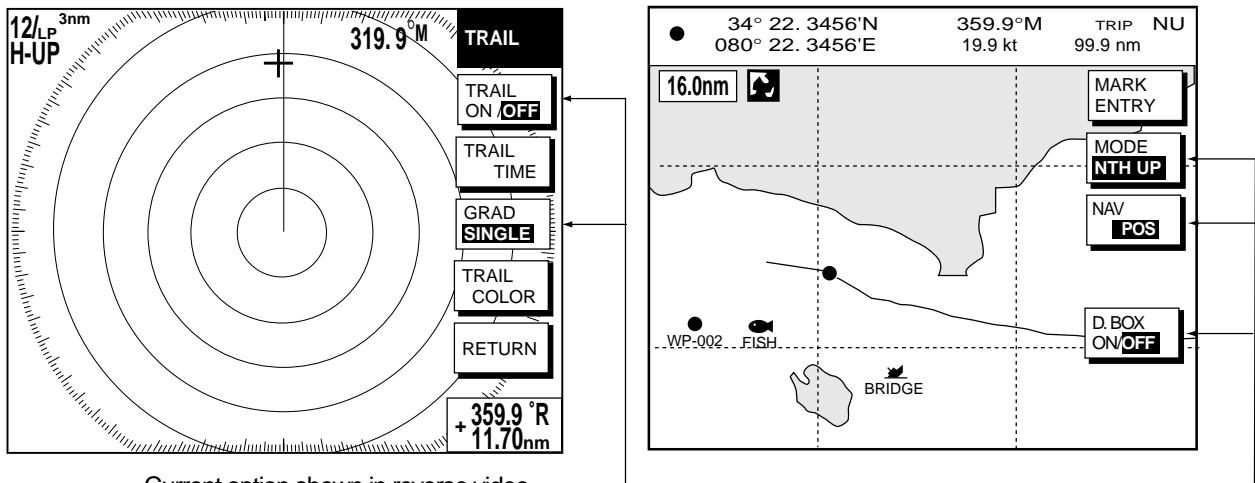

Current option shown in reverse video

Radar Display

Plotter Display

*Radar and plotter displays*

# 1. OPERATIONAL OVERVIEW

## 1.1.2 Remote controller

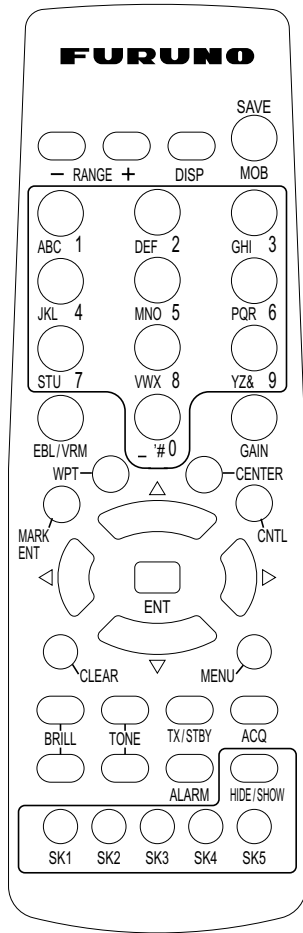

Operating distance

90°: Up to 5 m  
±45°: Up to 3 m

Replace the batteries (AA) when the distance from which the display unit can be operated shortens.

**Note:** The remote controller may become damaged if dropped. Mishandling of the remote controller is not covered by the warranty.

*Remote controller*

Key	Function	Key	Function
RANGE	Same as RANGE key on display unit.	ENT	Same as ENTER knob on display unit.
DISP	Same as DISP key on display unit.	CLEAR	Same as CLEAR key on display unit.
SAVE MOB	Same as SAVE/MOB key on display unit.	MENU	Same as MENU key on display unit.
Ten keys	Enter alphanumeric.	BRILL	Adjusts display brilliance.
EBL/VRM	Same as EBL/VRM key on display unit.	TONE	Not used.
GAIN	Same as GAIN key on display unit.	TX/STBY	Toggles radar between standby and transmit.
WPT	Displays "alphabet" WPT list on plotter display.	ACQ	Acquires radar target. (Requires radar source equipped with ARP.)
MARK ENT	Same as MARK ENTRY soft key.	ALARM	Same as ALARM key on the display unit.
CENTER	Returns own ship to screen center on plotter display.	HIDE/SHOW	Same as HIDE/SHOW key on display unit.
CNTL	Switches control between displays on combination displays.	SK1 – SK5 (soft keys)	Same as soft keys on display unit.

## 1.2 Inserting a Chart Card

Your unit reads FURUNO and Nav-Charts™ (NAVIONICS) chart cards, or C-MAP chart cards, depending on the type of display unit you have. Insert the appropriate chart card for your area as follows:

1. Open the chart drive.

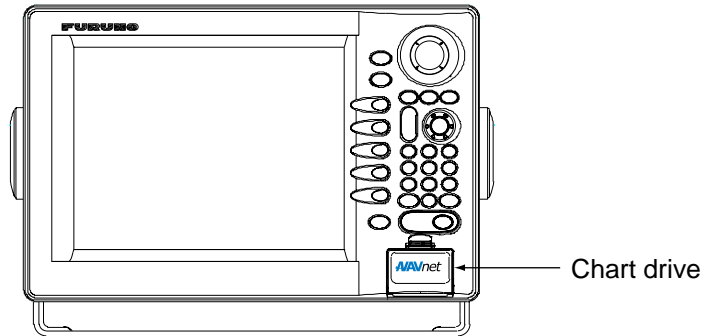

*Display unit*

2. Insert desired chart card groove side up.
3. Close the lid to protect the chart drive.

**Note 1:** Do not remove a card while the chart is being drawn. This may cause the equipment to freeze.

**Note 2:** Do not insert or remove a card while the power is on. This may cause the equipment to freeze.

**Note 3:** For multiple display units, do not use the same chart card type in more than one display unit.

**Note 4:** A card remover is supplied to ease removal of chart cards. Attach the card remover to the right-hand side hole of the card and pull it to remove the card. You can leave the remover attached to the card while the card is in the chart drive. Push the remover leftward until it contacts the recessed area on the card.

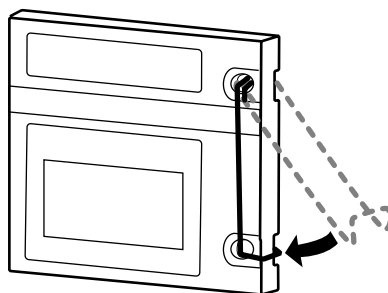

*Chart card and card remover*

### 1.3 Turning the Unit On/Off

Press the [POWER/BRILL] key to turn the unit on. A beep sounds and the equipment proceeds in the sequence shown below, displaying product information, startup test results and the chart usage disclaimer. The startup test checks the ROM, RAM, internal battery and backup data for proper operation, displaying the results for each as OK or NG (No Good). If NG appears an appropriate message appears on the screen. For any NG, try to press any key to go to the chart disclaimer screen, then perform the diagnostic test as shown in the paragraph "7.6 Diagnostics."

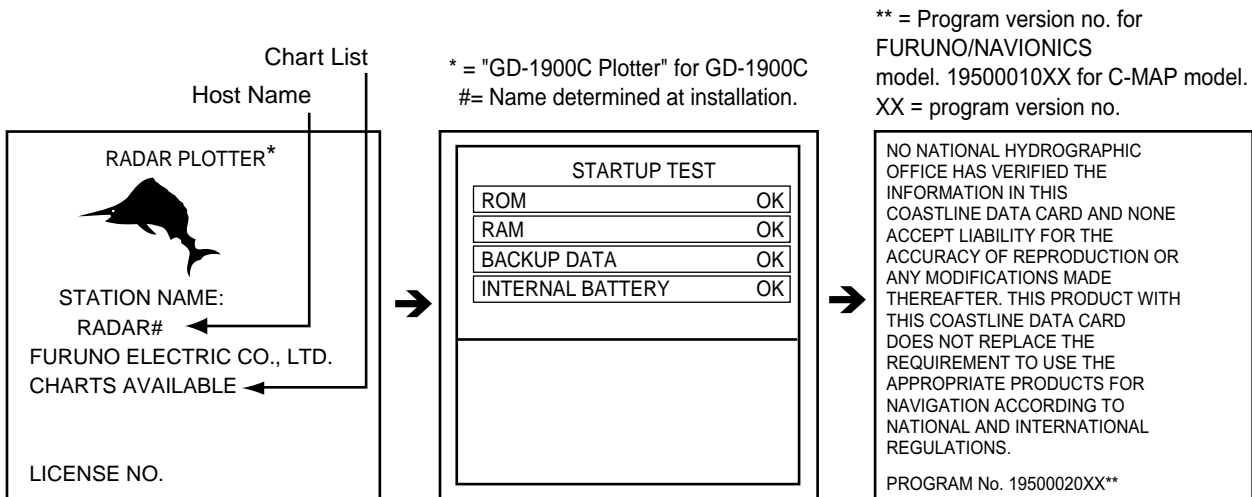

Startup sequence

**For start up with the radar display,** the magnetron takes from one minute to two minutes and thirty seconds (depending on radar model) to warm up before the radar can be operated. The time remaining for warm up of the magnetron is counted down at the center of the display.

You may press any key at the chart disclaimer screen to show the last-used display, or wait several seconds to let the equipment do it for you.

To turn the unit off, press and hold down the [POWER/BRILL] key until the screen goes dark (approx. 3 sec.). To protect the LCD attach the hard cover. Note that the network sounder will be turned off approx. three minutes after turning off the power.

**Note:** The first time you turn on the power (or any time the power is applied after a memory reset), you are asked if you want to start the simulation mode, which provides simulated operation of the equipment. Push the [ENTER] knob to start the simulation mode, or press the [CLEAR] key to start normal operation. For further details about the simulation mode, see the paragraph "1.10 Simulation Display."

## 1.4 Display Brilliance, Panel Brilliance, Hue

You can adjust display brilliance, panel brilliance and hue as shown below.

### 1.4.1 Display brilliance, panel brilliance

1. Press the [POWER/BRILL] key momentarily. A set of soft keys for adjustment of brilliance and hue appear.

Active soft key is highlighted.

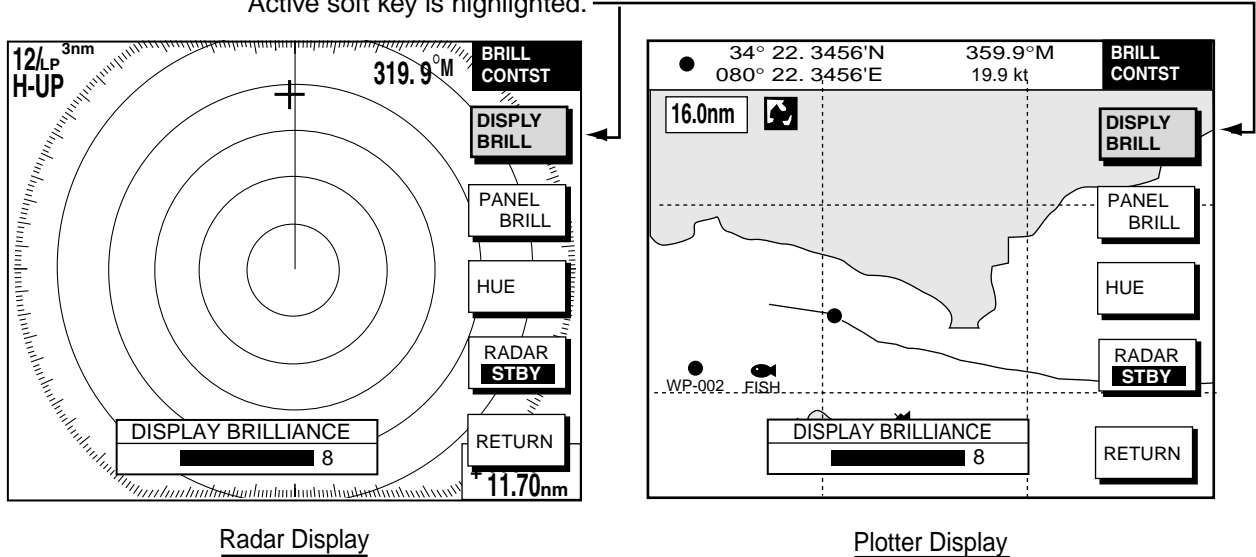

*Brilliance adjustment soft keys*

2. Press the DISPLY BRILL or PANEL BRILL soft key as appropriate. An adjustment window appears at the bottom of the screen. This window shows the name of the item selected for adjustment plus current brilliance level, by bar graph.

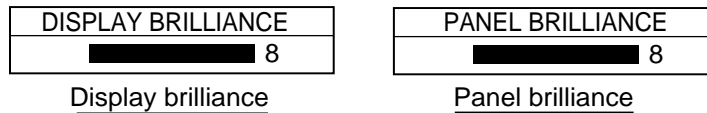

*Display brilliance and panel brilliance windows*

3. Adjust the [ENTER] knob, clockwise to raise the setting or counterclockwise to decrease it. You may also use the soft key pressed at step 2. Eight levels of display brilliance and panel brilliance are available.
4. Hit the RETURN soft key to finish.

**Note 1:** If the unit is turned off with minimum brilliance, the screen will be dark at the next power-up. Press the [POWER/BRILL] key consecutively to adjust the brilliance.

**Note 2:** This equipment does not have a contrast control.

### 1.4.2 Hue

You may select the colors for the radar, plotter and overlay displays as below.

1. Press the [POWER/BRILL] key momentarily.
2. Press the HUE soft key to show the hue setting window.

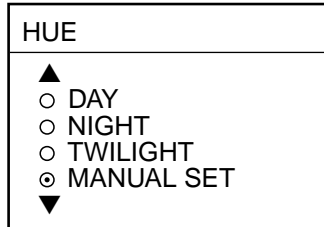

*Hue window*

3. Operate the trackball to select hue desired, referring to the table below. MANUAL SET follows the color settings on the CHART DETAILS menu for the plotter and the RADAR DISPLAY SETUP menu for the radar.

	<b>Night</b>	<b>Day</b>	<b>Twilight</b>
Characters	Red	Black	Green
Radar ring	Red	Green*	Green*
Radar echo	Orange	Red	Yellow
Background	Black	White	Blue
Landmass (plotter)	Light-Yellow	Yellow	Light-Yellow

\* = Red on C-MAP display unit.

4. Hit the RETURN soft key to finish.

**Note:** When using the overlay screen, the own ship track will be hidden if the radar background and own ship track are blue and the “MANUAL SET” hue setting is used. In this case, set HUE to other position and then return to “MANUAL” to show the own ship track in black.



## 1.5 Selecting a Display

### 1.5.1 Display modes

If you have a radar, navigator, network sounder and external video source (video recorder, etc., optional PIP board required) six full-screen displays are available: radar, plotter, echo sounder, nav data, overlay, and external video. In addition to the full-screen display, you can divide the screen into halves and thirds to show two and three sets of images on a combination display.

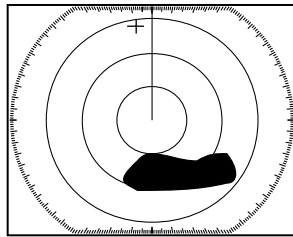

Full screen  
(radar)

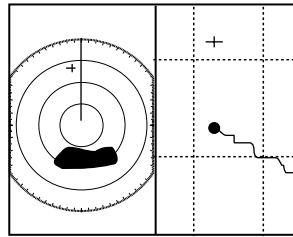

Combination screen  
(radar + plotter)

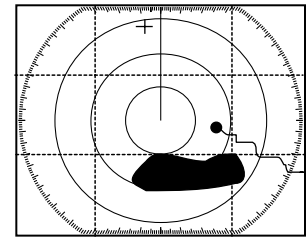

Overlay screen  
(plotter + radar only,  
Requires L/L data)

#### *Display screens*

The table below shows the displays available with each screen type.

#### Screen type and available display screen

Full screen	Combination screen options (half- or thirds-screen)	Overlay screen options
Plotter, radar, sounder, nav data, external video, overlay	Plotter, radar, sounder, compass, highway, compass/highway, nav data, overlay, external video	Radar + plotter

### 1.5.2 Selecting a display

1. Press the [DISP] key to show the display selection window. The icons of modes not available are shaded. HOTPAGE 1-HOTPAGE 6 are user-arrangeable displays called “hot pages,” which you can configure as you like. For further details, see the paragraph “5.6 Hot Page Setup.”

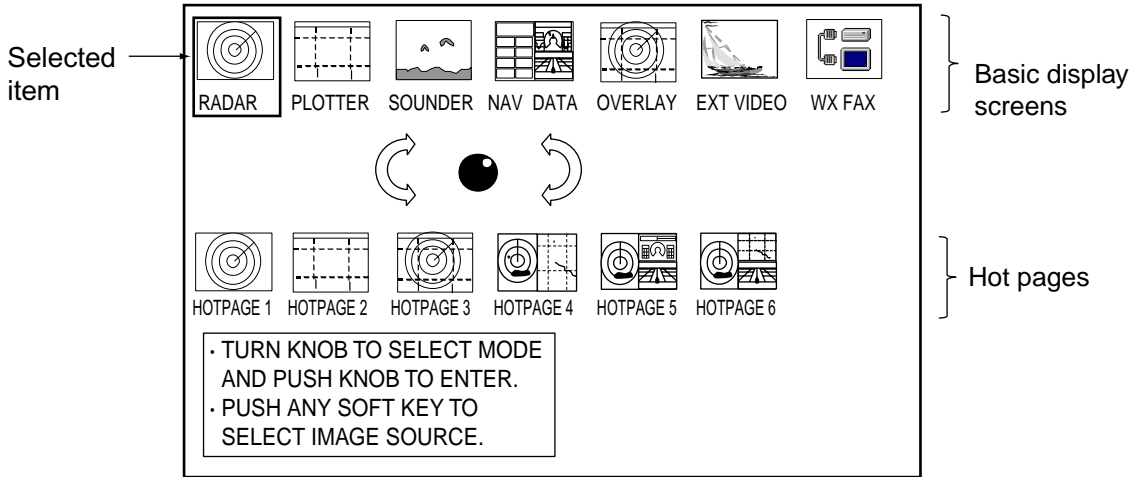

*Display screen selection window*

Note: “WX FAX” is available only when the facsimile receiver FAX-30 is connected. If “AUX SOURCE IS DISCONNECTED. PUSH ENT KNOB TO EXIT.” appears, press the [ENTER] knob and select other item.

2. Rotate the [ENTER] knob to select a basic display screen or a hot page screen.
3. Push the [ENTER] knob.
4. If you selected a basic display screen, a group of appropriate combination displays appear. In the example below, the radar combination screens are shown. When WX FAX is selected at step 2, a combination display does not appear.

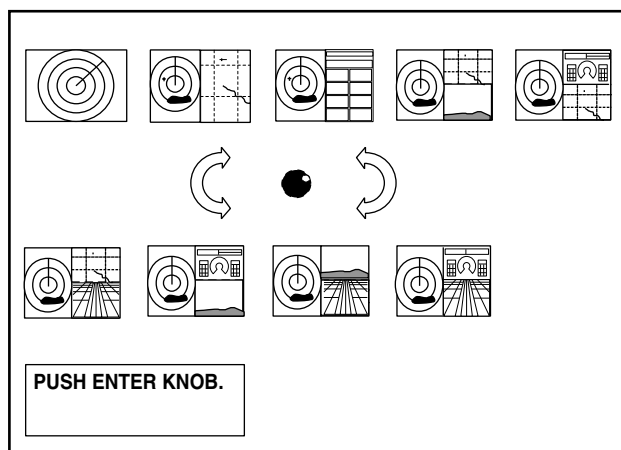

*Radar combination screen selection window*

5. Rotate the [ENTER] knob to select display desired.
6. Push the [ENTER] knob to finish.

### 1.5.3 Switching control in combination and overlay screens

A soft key is provided in relevant combination and overlay screens to switch control between displays. In the example below, the PLOTTR CNTRL and SNDR CNTRL soft keys enable switching control between the plotter and sounder screens in the plotter/sounder combination display.

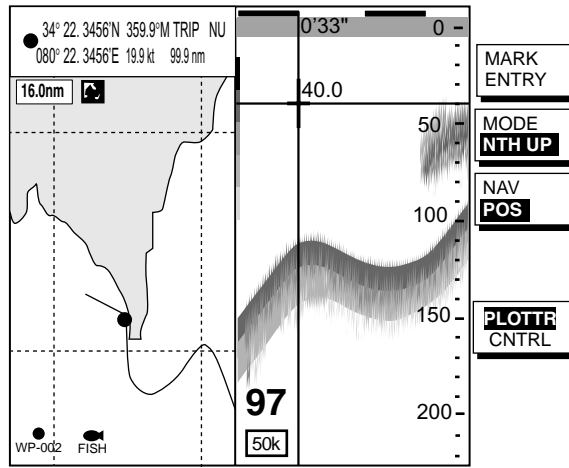

Plotter display selected

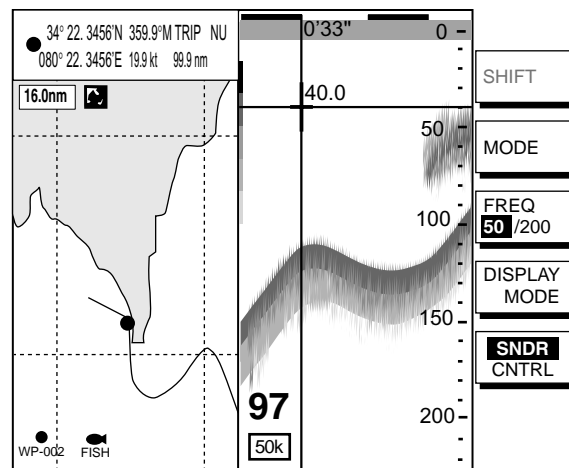
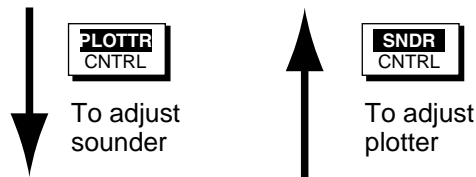

Sounder display selected

*How to switch control between modes in the plotter/sounder combination display*

### 1.5.4 Selecting image source

When more than one network radar or network sounder is connected to the equipment, you may select an image source for each as shown below. This is not necessary when only one network radar or network sounder is connected.

1. Press the [DISP] key.
2. Press any soft key to show the following display.

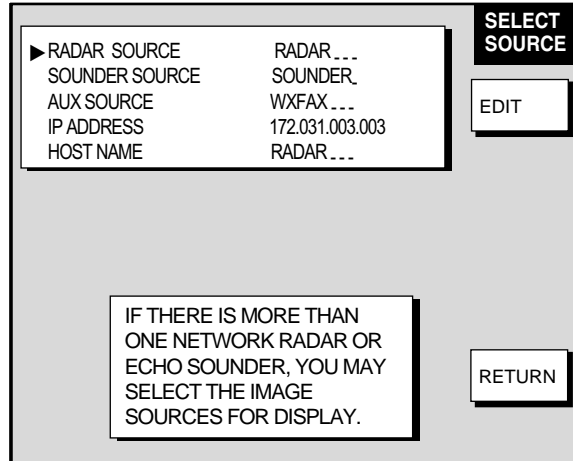

Select source menu

3. Use the trackball to select RADAR SOURCE, SOUNDER SOURCE or AUX SOURCE as appropriate, then press the EDIT key.

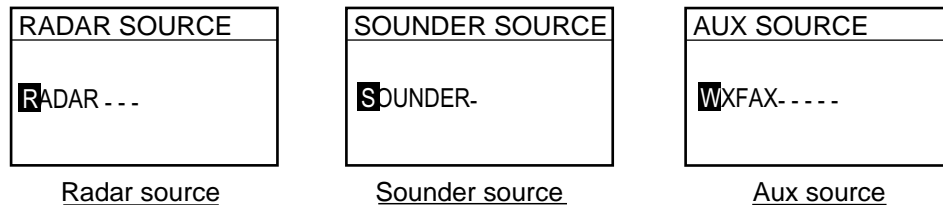

Radar source and sounder source windows

4. Use the trackball and alphanumeric keys to enter source name: Adjust the trackball to select location and enter character with the alphanumeric keys.
5. Push the [ENTER] knob to set.
6. Press the [DISP] key to finish.
7. Turn the power off and on again.

**Note:** Source names are determined at installation. For example, the source names for radars in a two radar system might be “RADAR” and “RADAR1”.

## 1.6 Trackball, Cursor

The trackball functions to shift the cursor, for measurement of range and bearing to a location (radar) and latitude and longitude position (plotter). Roll the trackball to shift the cursor. The cursor moves in the direction of trackball rotation.

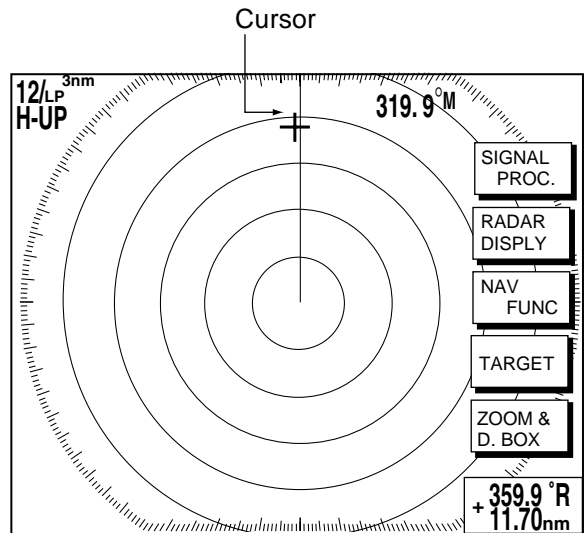

Cursor Data  
 Bearing from own ship to cursor  
 Range from own ship to cursor

Radar Display

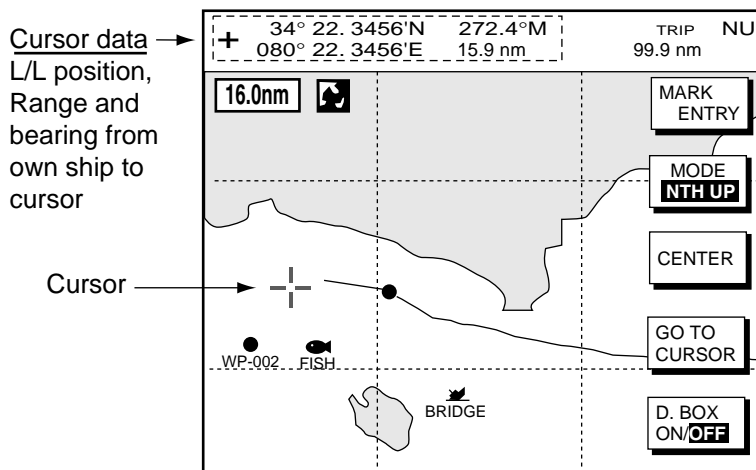

Plotter Display

*Cursor, cursor data*

## 1.7 Entering the MOB Mark, Setting MOB as Destination

The MOB (Man Overboard) mark functions to mark man overboard position. You can inscribe this mark from any mode, except while playing back data or conducting any test. Note that this function requires position data.

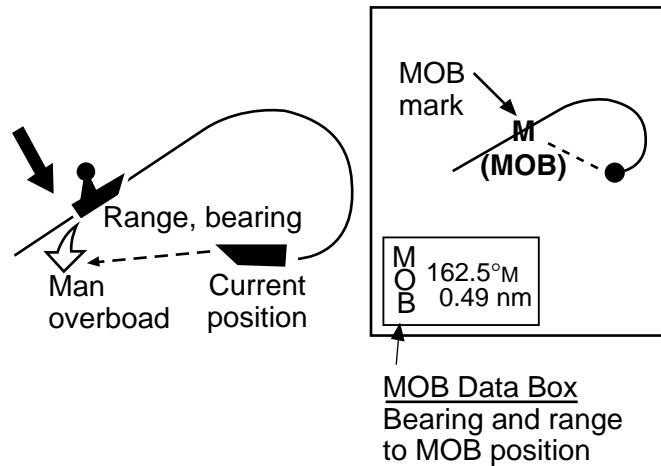

*MOB concept*

1. Press and hold down the [SAVE/MOB] key for about three seconds when someone falls overboard. The display shows the waypoint number being saved (youngest empty waypoint number, 001-999) followed by the MOB confirmation window.

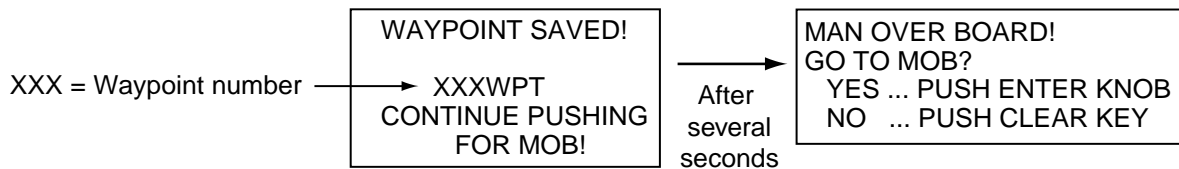

*MOB mark messages*

2. Push the [ENTER] knob to select the MOB position as the destination, or press the [CLEAR] key to only mark current ship's position as a waypoint. If you select the MOB position as destination;
  - A full-screen radar, plotter or overlay appears depending on the display in use.
  - The MOB mark "MOB" appears at the MOB position and a light-blue line runs between it and current position. This line shows the shortest course to the MOB position.
  - Range and bearing to the MOB position are shown in the MOB data box.

**To erase an MOB mark from the plotter display**, you must first erase its corresponding waypoint. Place the cursor on the MOB mark, then press the [CLEAR] key followed by pushing the [ENTER] knob to erase the waypoint. Then, repeat to erase the MOB mark.

## 1.8 Data Boxes

Data boxes, providing navigation data, may be shown on any full-screen display. Up to six data boxes (two in case of large characters) may be shown, and the default data boxes are position (in latitude and longitude), course over ground, speed over ground and trip log. The user may choose which data to display, where to locate it, and show or hide it as desired. In addition, data boxes may be set independently for each display mode (plotter, radar, sounder). For how to select data for the data boxes, see the paragraph “5.5 Data Boxes Setup.”

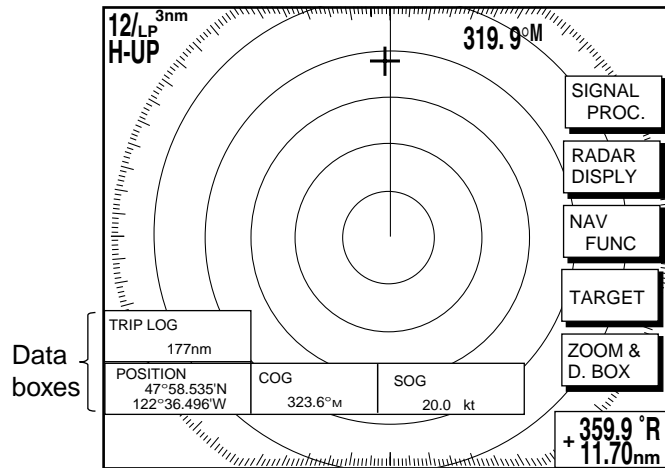

Radar Display

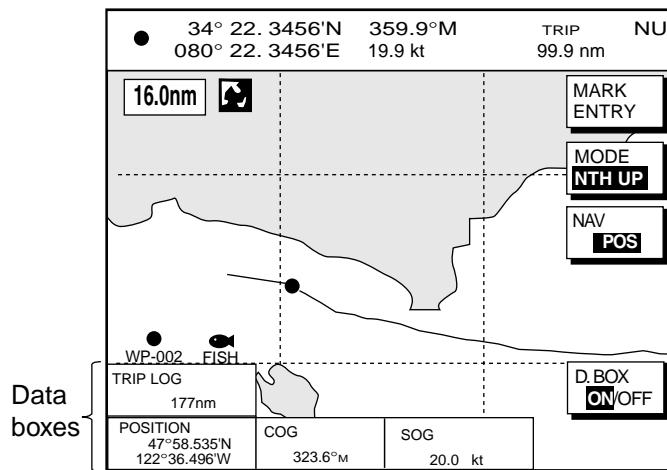

Plotter Display

*Data boxes*

### 1.8.1 Showing, hiding data boxes with soft key

**Plotter:** D. BOX ON/OFF

**Radar:** ZOOM & D. BOX → D. BOX ON/OFF (EBL/VRM data box, cursor data box also shown/hidden)

**Sounder:** AUTO/D. BOX→D. BOX ON/OFF

## **1.8.2 Rearranging data boxes**

You may select the location for data boxes as follows:

1. Using the trackball, place the cursor inside the data box you wish to move. As the cursor enters the box it changes to a hand. Push the [ENTER] knob, and the hand changes to a fist, meaning the box is correctly selected.
2. Use the trackball to move the data box to the location desired, then push the [ENTER] knob.

## **1.8.3 Temporarily erasing a data box**

If a data box is obscuring a desired object you may temporarily erase the box. Use the trackball to place the cursor inside the data box you wish to erase, then press the [CLEAR] key. To redisplay the box, press the D. BOX soft key twice to display it.



## 1.9 Function Keys

The function keys provide for one-touch execution of a desired function. The default function key settings are as shown in the table below.

Function Key	Default Setting, Key Label		
	Radar	Plotter	Sounder
#1	Heading line on/off, HL	Track on/off, TRK	TLL output, TLL
#2	Rings on/off, RNG	Edit mark/line, EML	Clutter, CLT
#3	Echo trail, TRL	Ruler, RUL	Signal level, SLV
#4	Offcenter, SFT	Add new waypoint, ADD	Noise limiter, NL
#5	Radar source, RSR	Waypoint alphanumeric list, ALP	Picture advance, PA

### 1.9.1 Executing a function

1. Press the [HIDE/SHOW] key to replace the preset soft key labels with the function key labels.

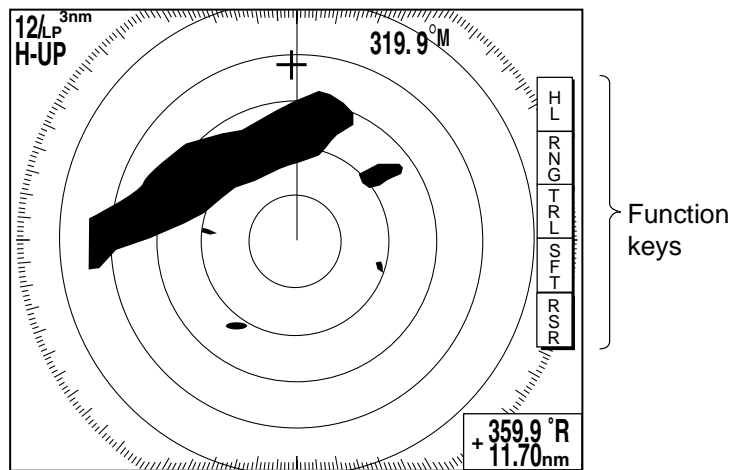

Radar Display

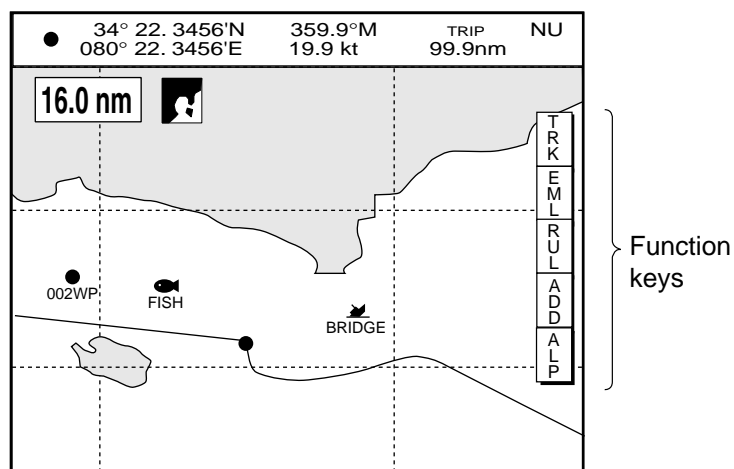

Plotter Display

Function keys

## 1. OPERATIONAL OVERVIEW

2. Press function key desired.

**Note:** Function keys can be individually programmed for the plotter, radar and sounder displays. For further details see the following:

Radar: paragraph 5.2.3

Plotter: paragraph 5.3.2

Sounder: paragraph 5.9.4

### 1.10 Simulation Display

The simulation display, for use by service technicians for demonstration purposes, provides simulated operation to help acquaint you with the many features your unit has to offer. It allows you to view and control a simulated plotter, radar and sounder picture, without position-fixing equipment, network radar or a network sounder. Most controls are operative, thus you may practice setting destination, enter waypoints, measure range and bearing to a target, etc.

The simulation icon () appears when any simulation mode is active.

To start the simulation display;

1. Press the [MENU] key.
2. Press the SYSTEM CONFIGURATION, SYSTEM SETUP and SIMULATION SETUP soft keys in that order.

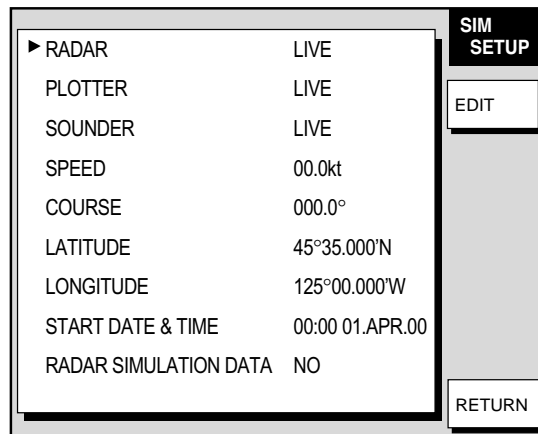

*Simulation setup menu*

3. Follow appropriate procedure on the next several pages.

**Radar****NavNet display unit-generated echoes**

1. Select RADAR, then press the EDIT soft key.

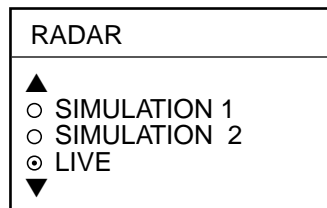

2. Select SIMULATION 1, then push the [ENTER] knob.
3. Press the [MENU] key to close the menu.

**NavNet radar antenna-generated echoes (not available with the GD-1900C)**

1. Select RADAR SIMULATION DATA, then press the EDIT soft key.
2. Select YES, then push the [ENTER] knob to erase simulation data and get new data. The message "Now getting demo data. Do not turn off display unit." appears while the unit is receiving radar data.

**Note:** If the network radar could not be found "Radar source is not found. Cannot get demo data." appears. And if the radar is not active, the message "Radar is not active. Cannot get demo data." is displayed. Check that the radar is plugged in and its signal cable is firmly fastened.

3. Select RADAR, then press the EDIT soft key.
4. Select SIMULATION 2, then push the [ENTER] knob.
5. Press the [MENU] key to close the menu.

**Plotter**

1. Select PLOTTER, then press the EDIT soft key.

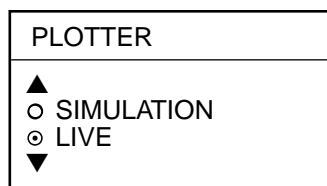

2. Select SIMULATION, then push the [ENTER] knob.
3. Select SPEED, then press the EDIT soft key.
4. Enter speed (setting range, 0-99 kt, default speed, 0 kt) with the alphanumeric keys, then push the [ENTER] knob.
5. Select COURSE, then press the EDIT key.
6. Select "8 FIGURE" to trace the simulated ship's track in a figure-eight course, or enter your own course at DIRECTION. To enter course, use the trackball to select digit, and enter value with the alphanumeric keys.
7. Press the ENTER soft key.
8. Select LATITUDE, then press the EDIT soft key.
9. Enter latitude (setting range, 85°N-85°S, default setting, 45°35.000'N), then push the [ENTER] knob.
10. Select LONGITUDE, then press the EDIT soft key.

## 1. OPERATIONAL OVERVIEW

11. Enter longitude (setting range, 180°E-180°W, default setting, 125°00.000°W), then push the [ENTER] knob.
12. Select START DATE & TIME, then press the EDIT soft key.
13. Enter start date and time, then push the [ENTER] knob.
14. Press the [MENU] key to close the menu.

### Sounder

1. Select SOUNDER, then press the EDIT soft key.

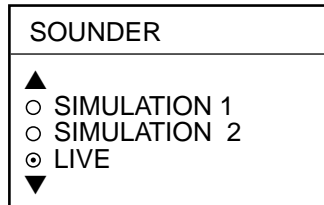

2. Select SIMULATION 1 (internally generated echoes) or SIMULATION 2 (network sounder-generated echoes), then push the [ENTER] knob.

**Note:** The depth, shift, bottom-zoom, bottom-lock and bottom discrimination cannot be shown at SIMULATION 1 mode.

3. Press the [MENU] key to close the menu.

# 2. RADAR OPERATION

This chapter covers radar operation, including the ARP (Auto Plotter) function. ARP requires a Model 1800/1900 series network radar equipped with the ARP circuit board.

## 2.1 Radar Display

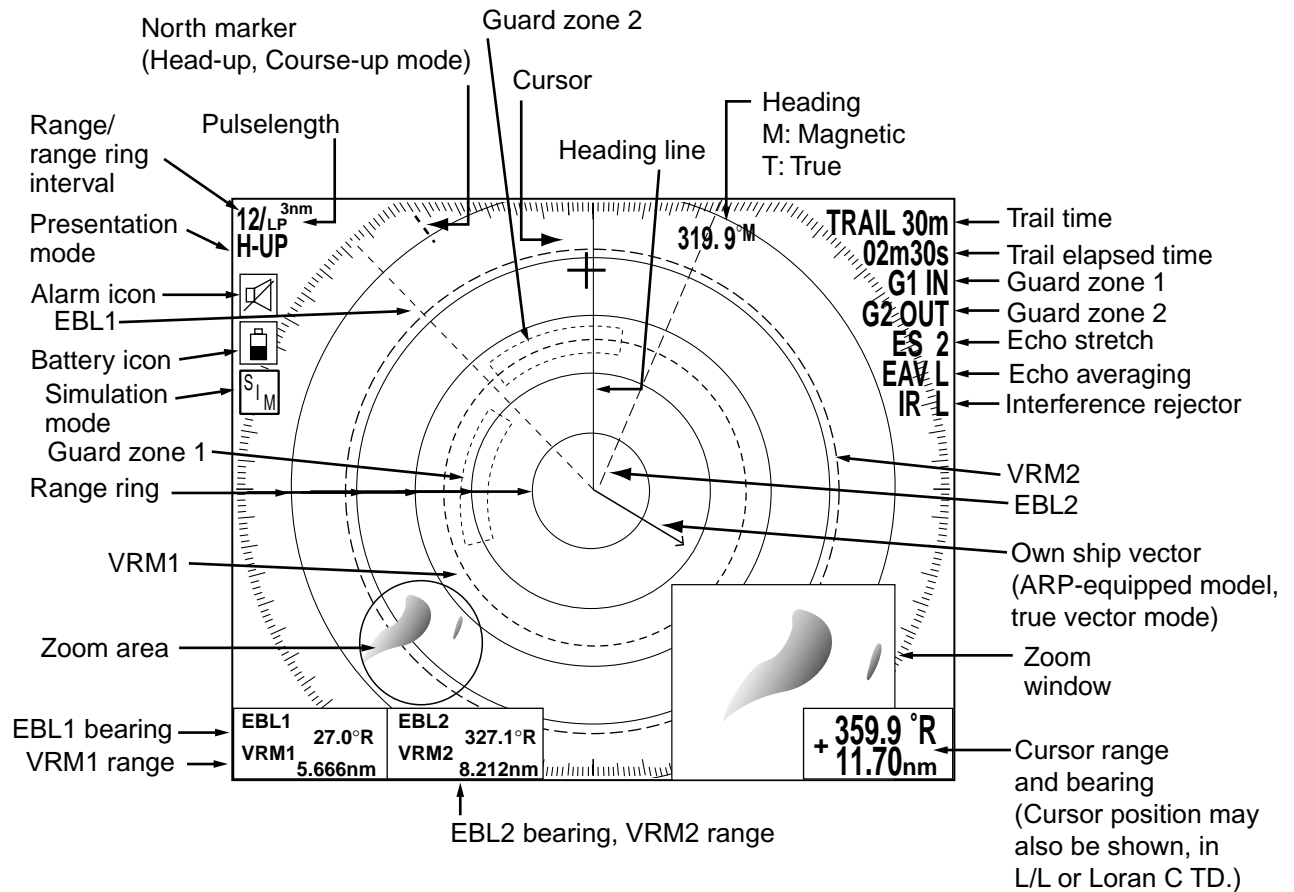

Radar display

## 2.2 Transmitting, Stand-by

1. Confirm that the network radar is plugged in.
2. Press the [DISP] key to select a radar display.
3. Press the [POWER/BRILL] key momentarily.
4. Press the RADAR STBY soft key to highlight TX on its label.
5. Press the RETURN soft key.

When the radar picture is not required, but you want keep it in a state of readiness, press the RADAR TX soft key to highlight STBY on its label.

## 2.3 Tuning

The radar receiver can be tuned automatically or manually, and the default tuning method is automatic. If you require manual tuning, do the following:

1. Press the [MENU] key to display the main menu.
2. Press the RADAR DISPLAY SETUP soft key.
3. Select TUNING, then press the EDIT soft key.

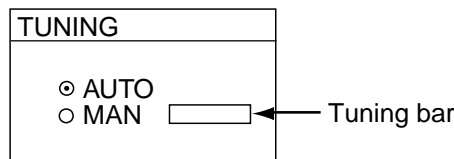

*Tuning window*

4. Choose MAN.
5. Adjust the [ENTER] knob until the tuning bar is at its longest position.
6. Press the [MENU] key to close the menu.

**Note:** If the auto setting does not provide satisfactory tuning, ask your dealer how to re-adjust tuning.

## 2.4 Adjusting the Gain

The [GAIN] key adjusts the gain sensitivity of the radar receiver. It works in a manner similar to that of volume control of a broadcast receiver, which amplifies received signals.

The proper setting is such that the background noise is just visible on the screen. If your gain setting is too low, weak echoes may be missed. On the other hand, excessive gain yields too much background noise; strong targets may be missed because of the poor contrast between desired echoes and the background noise on the display.

To adjust the receiver sensitivity, transmit on long range, and then do the following:

1. Press the [GAIN] key to show the “gain adjustment” soft keys, and the last-used adjustment window appears. The example below shows the gain sensitivity adjustment window. The gain soft keys shown depend on radar source as shown below.

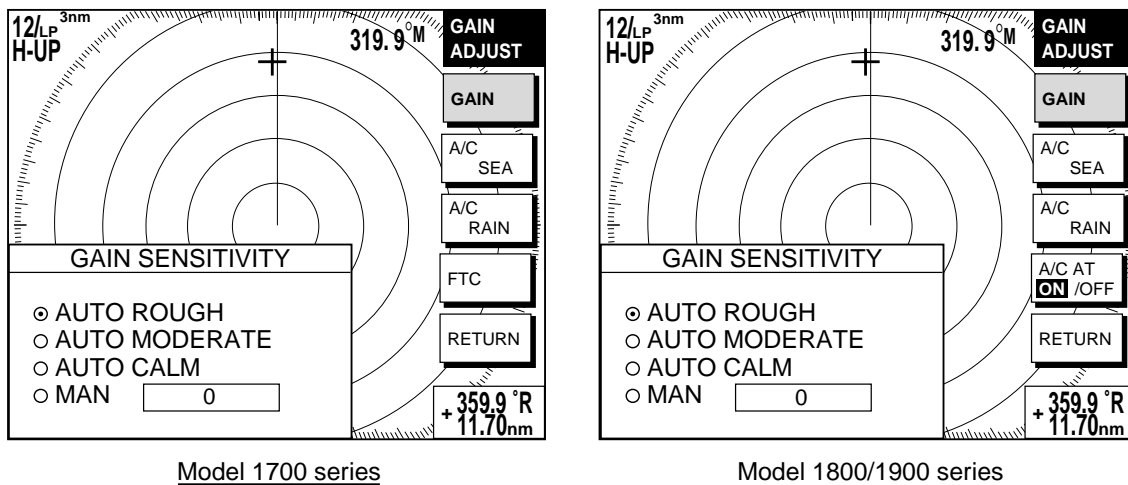

#### *Gain adjustment soft keys*

2. Press the GAIN soft key to show the gain sensitivity setting window.

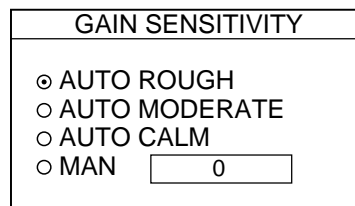

#### *Gain sensitivity window*

3. Use the trackball to select AUTO ROUGH, AUTO MODERATE, AUTO CALM, or MAN (manual) as appropriate. Select an AUTO option according to the sea state.
4. For manual adjustment, rotate the [ENTER] knob to adjust, while observing the radar echo. The range of adjustment is 0-100.
5. Press the [GAIN] key on the front panel or the RETURN soft key to finish.

#### **Adjusting the FTC (When the radar source is the 1700 series radar)**

To suppress rain clutter from heavy storms or scattered rain clutter, adjust the FTC.

In addition to reducing clutter, the FTC can be used in fine weather to clarify the picture when navigating in confined waters. However, with the circuit active the receiver is less sensitive. Therefore, turn off the FTC, by setting it for “0”, when its function is not required.

1. Press the [GAIN] key.
2. Press the FTC soft key to show the FTC window.
3. Rotate the [ENTER] knob to adjust. The range of adjustment is 0-100(%). Do not overadjust the FTC – weak target echoes may be missed.
4. Press the [GAIN] key on the front panel or RETURN soft key to finish.

## 2.5 Reducing Sea Clutter

### 2.5.1 How the A/C SEA works

Echoes from waves can be troublesome, covering the central part of the display with random signals known as “sea clutter”. The higher the waves and the higher the antenna above the water, the further the clutter will extend. Sea clutter may affect radar performance because real targets are sometimes hidden by the echoes of small waves. (See the left-hand figure in the figure below.) When sea clutter masks the picture, adjust the A/C SEA to reduce the clutter.

The A/C SEA reduces the amplification of echoes at short ranges (where clutter is the greatest) and progressively increases amplification as the range increases, so amplification will be normal at those ranges where there is no sea clutter.

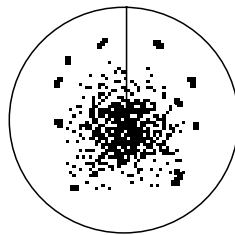

Sea clutter at screen center

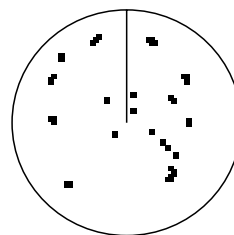

A/C SEA adjusted; sea clutter suppressed

*Effect of A/C SEA*

### 2.5.2 Adjusting the A/C SEA

A/C SEA should be adjusted so that the clutter is broken up into small dots, and small targets become distinguishable.

1. Press the [GAIN] key.
2. Press the A/C SEA soft key to show the A/C SEA setting window.

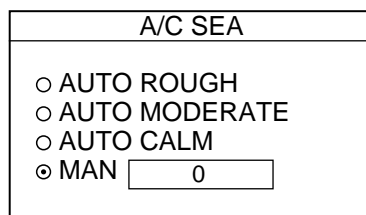

Model 1700 series radar

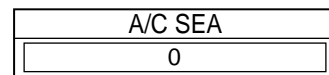

Model 1800/1900 series radar

*A/C SEA setting window*

3. **When the radar source is the Model 1700 series**, use the trackball to select AUTO ROUGH, AUTO MODERATE, AUTO CALM, or MAN (manual) as appropriate. Select an AUTO option according to the sea state.
4. For manual adjustment, rotate the [ENTER] knob to adjust. The range of adjustment is 0-100. Do not overadjust – weak echoes may be missed.



5. **When the radar source is the Model 1800/1900 series**, A/C SEA and A/C RAIN can be automatically adjusted. Press the A/C AT ON/OFF soft key to select ON or OFF as appropriate. When turned on, it overrides A/C SEA and A/C RAIN settings.
6. Press the [GAIN] key on the front panel or RETURN soft key to finish.

## 2.6 Reducing Precipitation Clutter

The vertical beamwidth of the antenna is designed to see surface targets even when the ship is rolling. However, by this design the unit will also detect precipitation clutter (rain, snow, hail, etc.) in the same manner as normal targets. Precipitation clutter shows as random dots on the screen.

### 2.6.1 Adjusting the A/C RAIN

When echoes from precipitation mask solid targets, adjust the A/C RAIN to split up these unwanted echoes into a speckled pattern, making recognition of solid targets easier.

1. Press the [GAIN] key.
2. Press the A/C RAIN soft key to show the A/C RAIN window.

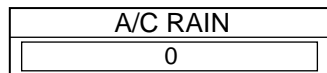

*A/C RAIN setting window*

3. Rotate the [ENTER] knob to adjust the A/C RAIN. The current level is shown on the A/C RAIN level bar in the A/C RAIN window, and the range of adjustment is 0 to 100(%). Do not overadjust – weak echoes may be missed.
4. Press the [GAIN] key on the front panel or RETURN soft key to finish.

## 2.7 Range Scale

The range setting determines the size of the area (in nautical miles) that will appear on your display. In addition, the range setting will also automatically adjust the range ring interval so that accurate range measurements may be made while operating on any range setting.

The range, range ring interval and pulselength appear at the top left-hand corner of the display.

Press the [RANGE (+ or -)] key to change the range scale.

### Range scales (nm, sm)

Range	0.125	0.25	0.5	0.75	1	1.5	2	3	4	6	8	12	16	24	36	48	64	72
Ring Interval	0.0625	0.125	0.125	0.25	0.25	0.5	0.5	1	1	2	2	3	4	6	12	12	16	18
No. of Rings	2	2	4	3	4	3	4	3	4	3	4	4	4	4	3	4	4	4

### Range scales (km)

Range	0.25	0.5	0.75	1	1.5	2	3	4	6	8	12	16	24	36	48	64	72
Ring Interval	0.125	0.25	0.25	0.25	0.5	0.5	1	1	2	2	3	4	6	12	12	16	18
No. of Rings	2	2	3	4	3	4	3	4	3	4	4	4	4	3	4	4	4

**Note 1:** Maximum range depends on the network radar as shown below.

Model 1722/1722C/1823C: 24 nm

Model 1732/1732C/1742/1742C/1833/1833C: 36 nm

Model 1762/1762C/1933/1933C: 48 nm

Model 1943/1943C: 64 nm

Model 1953C: 72 nm

**Note 2:** You may choose which ranges to use from the RADAR RANGE SETUP menu. For details see paragraph 5.2.2. This function is not available with the GD-1900C.

## 2.8 Pulselength

The pulselength in use is displayed at the upper left corner of the display. Appropriate pulselengths are preset to individual range scales. Therefore, you are not usually required to select them. If you are not satisfied with the current pulselength setting, however, it is possible to change it for the ranges shown below. Generally, select a longer pulse for longer detection range and shorter pulse for better range discrimination.

1.5 nm, 1.5 sm, 3 km: Short pulse, medium pulse  
 3 nm, 3 sm, 6 km: Medium pulse, long pulse

1. If not displayed, press the [HIDE/SHOW] key to show the radar soft keys.
2. Press the SIGNAL PROC. soft key.

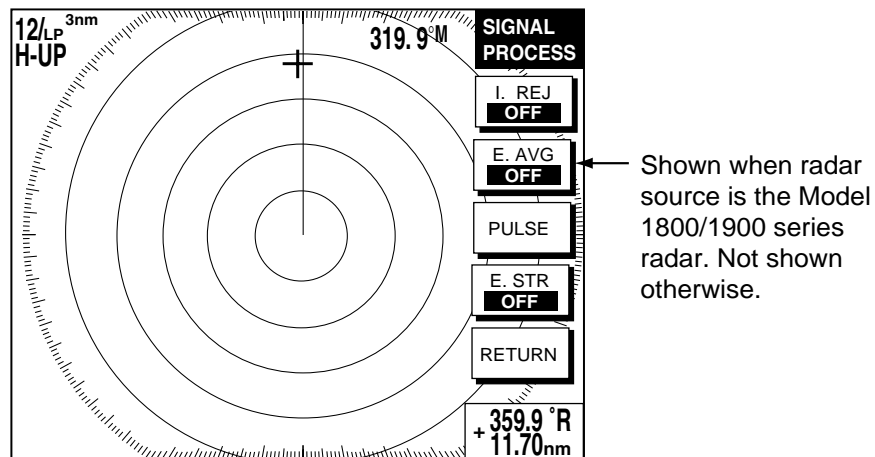

*Signal process soft keys*

3. Choose the 1.5 nm or 3 nm with the RANGE key.
4. Press the PULSE soft key to select the pulselength setting. SHORT or MEDIUM for 1.5 nm, 1.5 sm, 3 km and MEDIUM or LONG for 3 nm, 3 sm, 6 km.
5. Press the RETURN soft key to finish.

## 2.9 Presentation Mode

This unit provides four radar presentation modes: head-up, course-up, north-up and true motion.

Heading data is required for modes other than head-up.

### 2.9.1 Selecting a presentation mode

1. If not displayed, press the [HIDE/SHOW] key to show the radar soft keys.
2. Press the RADAR DISPLY soft key to show the RADAR DISPLAY soft keys.

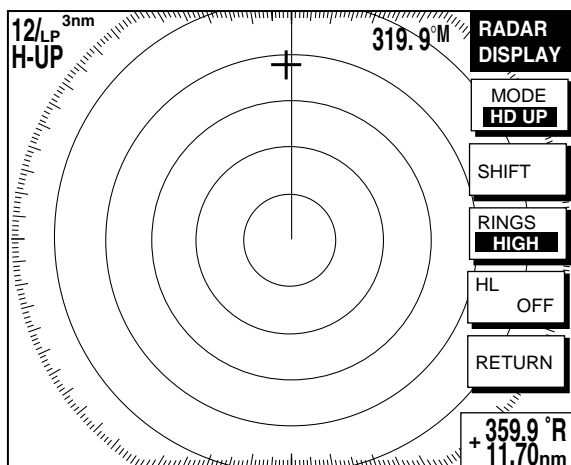

*Radar display soft keys*

3. Press the MODE soft key. Each pressing of the key changes the presentation mode and the presentation mode indication in the sequence of North-up, True Motion, Head-up, and Course-up.

Function	Indicator on display	Soft key label
North-up	N-UP	NTH UP
True Motion	TR-M	TRUE M
Head-up	H-UP	HD UP
Course-up	C-UP	CSE UP

4. Press the RETURN soft key to finish.

**Note:** When heading data is lost, the presentation mode automatically goes to head-up, the heading indication at the screen top shows “- - -.°” and the audio alarm sounds. Press the [ALARM] key to acknowledge the alarm. The message “HEADING DATA MISSING” appears. Restore compass signal to show heading indication. Use the MODE soft key to select presentation mode if necessary. The audio alarm may be silenced with the [CLEAR] key.

## 2.9.2 Description of presentation modes

### Head-up

A display without azimuth stabilization in which the line connecting the center with the top of the display indicates own ship's heading. Targets are painted at their measured distances and in their directions relative to own ship's heading.

The short line on the bearing scale is the north marker.

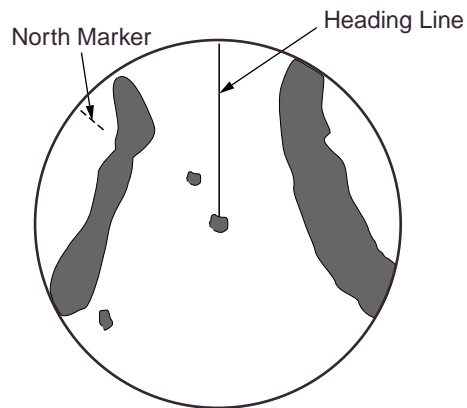

*Head-up presentation mode*

### Course-up

The radar picture is stabilized and displayed with the currently selected course at the top of the screen. As you change heading, the ship's heading line moves. If you select a new course, the picture resets to display the new course at the top of the display.

Targets are painted at their measured distances and in their directions relative to the intended course which is maintained at the 0-degree position. The heading line moves in accordance with ship's yawing and course changes.

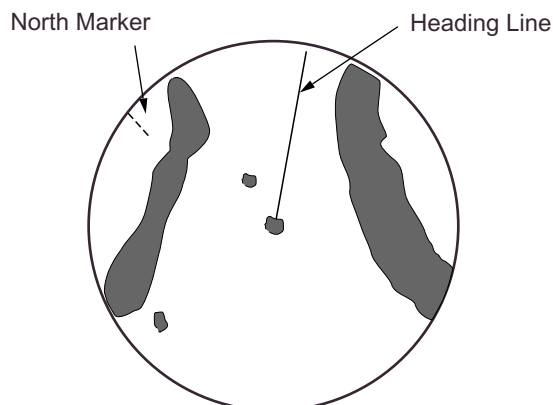

*Course-up presentation mode*

## 2. RADAR OPERATION

### North-up

In the north-up mode, targets are painted at their measured distances and in their true (compass) directions from own ship. North is maintained at the top of the screen. The heading line changes its direction according to ship's heading.

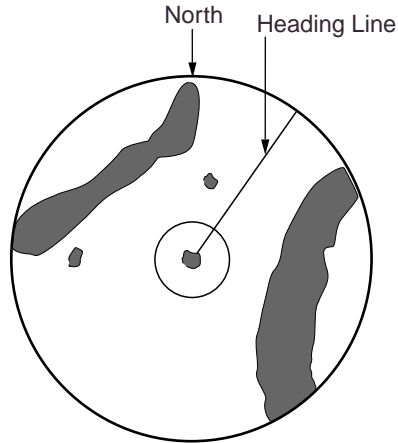

*North-up presentation mode*

### True motion

Fixed radar targets maintain a constant position on the screen, while your own ship moves across the radar image at the correct speed and heading. A map-like image is displayed, with all moving vessels traveling in true perspective to each other and to fixed landmasses. As your ship's position approaches the edge of the screen, the radar display is automatically reset to reveal the area ahead of your ship. You can manually reset your ship's position at any time by pressing the RADAR DISPLY soft key followed by the SHIFT soft key.

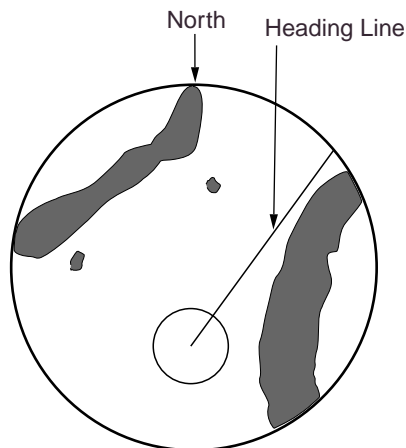

*True motion presentation mode*

## 2.10 Measuring the Range

You can measure the range to a radar target three ways: by the range rings, by the cursor, and by the VRM (Variable Range Marker).

### 2.10.1 Measuring range by range rings

Count the number of rings between the center of the display and the target. Check the range ring interval and judge the distance of the echo from the inner edge of the nearest ring.

To turn the range rings on, do the following:

1. If not displayed, press the [HIDE/SHOW] key to show the radar soft keys.
2. Press the RADAR DISPLAY soft key.

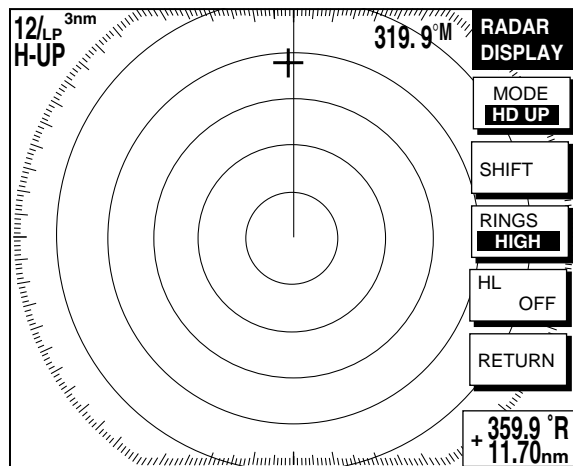

*Radar display soft keys*

3. Press the RINGS soft key to turn the rings on and select desired brilliance.
4. Press the RETURN soft key to finish.

## 2. RADAR OPERATION

### 2.10.2 Measuring range by cursor

Operate the trackball to place the cursor intersection on the inside edge of the radar target. The range to the target, as well as the bearing, appears to the right of “+” at the bottom of the display.

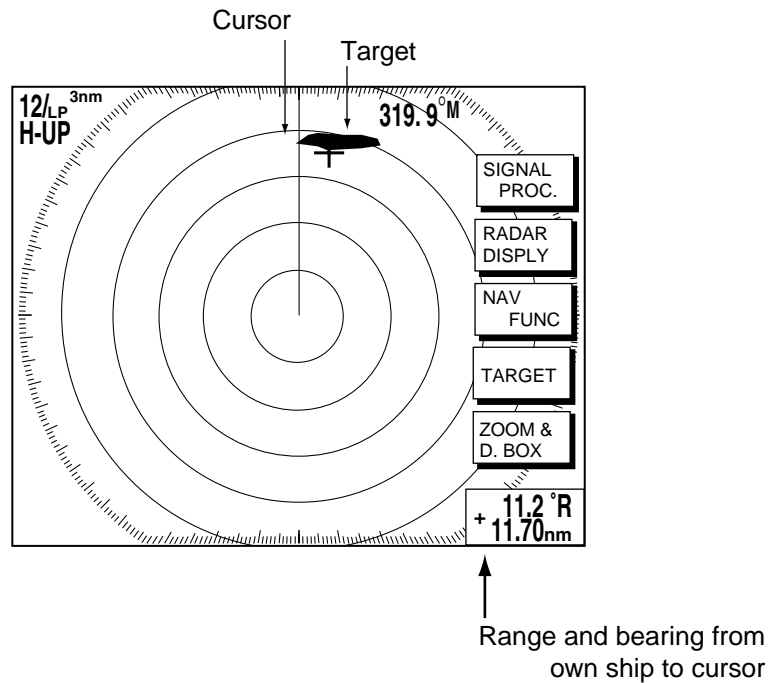

*How to measure range to a target with the cursor*



### 2.10.3 Measuring range by VRM

1. Press the [EBL/VRM] key to display the EBL/VRM soft keys.

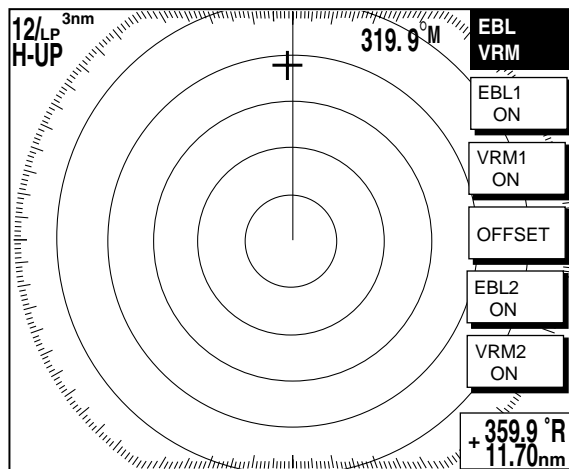

*EBL/VRM soft keys*

2. Press the VRM1 ON (dotted ring VRM) or VRM2 ON (dashed ring VRM) soft key to select the desired VRM. The selected VRM's indication, at the bottom of the screen, is highlighted.
3. Rotate the [ENTER] knob to place the VRM on the inside edge of a radar target. Read the VRM indication to find range to the target.

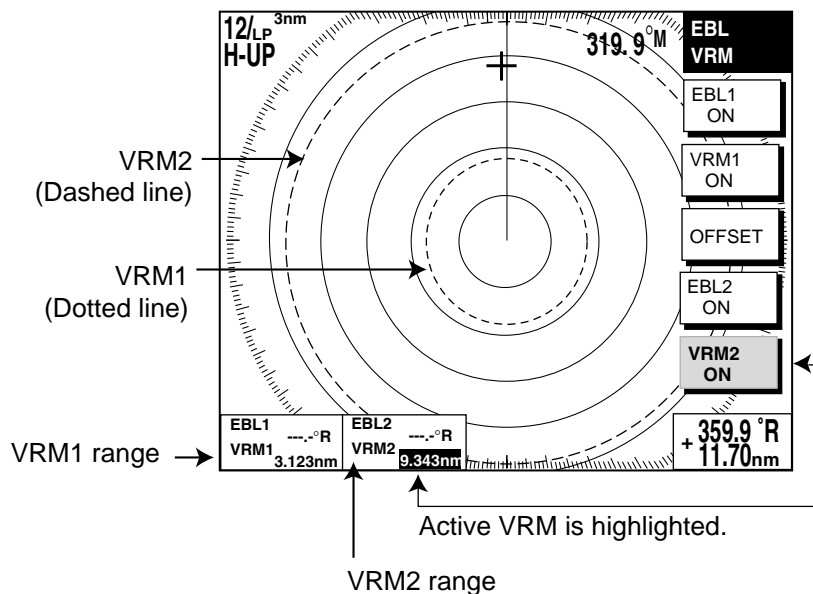

4. You may hide the EBL/VRM soft keys by pressing the [EBL/VRM] key.

*How to measure range with the VRM*

## 2. RADAR OPERATION

### 2.10.4 Erasing a VRM, VRM indication

Press appropriate VRM soft key, then press the [CLEAR] key. The VRM is erased and its indication becomes blank.

### 2.10.5 Erasing EBL/VRM data boxes

Press the EBL or VRM soft key associated with the EBL/VRM data box you wish to erase. Press the [CLEAR] key once or twice to erase the data box.

### 2.10.6 Hiding EBL/VRM data boxes

Press the ZOOM & D. BOX and D. BOX ON/OFF soft keys to show or hide the EBL/VRM data boxes.

### 2.10.7 Moving EBL/VRM data boxes

When an EBL/VRM data box is obscuring a target you want to see, you can move it to another location as shown below. This cannot be done when the EBL/VRM soft keys are shown.

1. Press the [EBL/VRM] key to turn off the EBL/VRM soft keys.
2. Using the trackball, place the cursor inside the data box you wish to move. As the cursor enters the box it changes to a "hand." Push the [ENTER] knob, and the hand changes to a fist, meaning the box is correctly selected.
3. Use the trackball to move the data box to the location desired, then push the [ENTER] knob.

## 2.11 Measuring the Bearing

There are two ways to measure the bearing to a target: by the cursor, and by the EBL (Electronic bearing Line).

### 2.11.1 Measuring bearing by cursor

Use the trackball to place the cursor at the center of the target. The bearing to the target appears in the range and bearing box at the bottom right-hand corner on the screen.

### 2.11.2 Measuring bearing by EBL

1. Press the [EBL/VRM] key.
2. Press the EBL1 ON (dotted line EBL) or EBL2 ON (dashed line EBL) soft key to select the desired EBL. The selected EBL's indication, at the bottom of the screen, is highlighted.
3. Rotate the [ENTER] knob to bisect the radar target with the EBL. Read the EBL indication to find the bearing to the target.

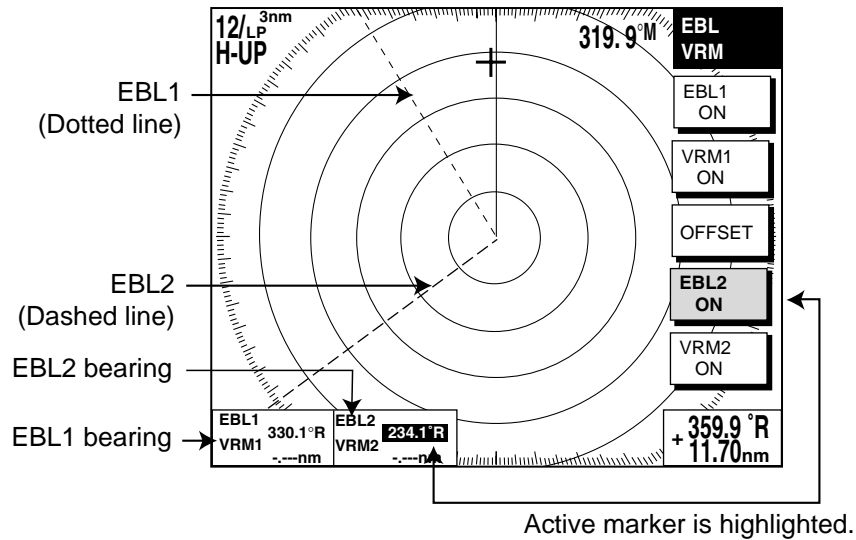

#### *How to measure bearing with the EBL*

4. You may hide the EBL/VRM soft keys by pressing the [EBL/VRM] key.

**Note:** The bearing to a target may be shown relative to own ship's heading (Relative) or True bearing (requires heading data). This may be done with "EBL REFERENCE," which is in the RADAR DISPLAY SETUP menu.

### 2.11.3 Erasing an EBL, EBL indication

Press appropriate EBL soft key, then press the [CLEAR] key. The EBL is erased and its indication becomes blank.

### 2.11.4 Erasing EBL/VRM data boxes

Press the EBL or VRM soft key associated with the EBL/VRM data box you wish to erase. Press the [CLEAR] key once or twice to erase the data box.

### 2.11.5 Hiding EBL/VRM data boxes

Press the ZOOM & D. BOX and D. BOX ON/OFF soft keys to show or hide the EBL/VRM data boxes.

### 2.11.6 Moving EBL/VRM data boxes

When an EBL/VRM data box is obscuring a target you want to see, you can move it to another location as shown below. This cannot be done when the EBL/VRM soft keys are shown.

1. Press the [EBL/VRM] key to turn off the EBL/VRM soft keys.
2. Using the trackball, place the cursor inside the data box you wish to move. As the cursor enters the box it changes to a "hand." Push the [ENTER] knob, and the hand changes to a fist, meaning the box is correctly selected.
3. Use the trackball to move the data box to the location desired, then push the [ENTER] knob.

## 2.12 Erasing the Heading Line, North Marker

The heading line indicates the ship's heading in all presentation modes. It is a line from the own ship position to the outer edge of the radar display area and appears at zero degrees on the bearing scale in head-up mode; it changes its orientation in the north-up, course-up and true motion modes with ship's movement.

The north marker appears as a short dashed line. In the head-up and course-up modes the north marker moves around the bearing scale as the ship's heading moves.

To temporarily erase the heading line and north marker, press the RADAR DISPLAY soft key followed by the HL OFF soft key. Release the key to redisplay the markers. (If the radar soft keys are not shown, hit the [HIDE/SHOW] key to display them.)

## 2.13 Reducing Noise Interference

Noise, appearing on the displays as random "speckles," can be reduced as follows:

1. Press the [MENU] key to open the menu.
2. Press the RADAR DISPLAY SETUP soft key.
3. Select NOISE REJECTION, then press the EDIT soft key.
4. Select OFF, LOW or HIGH as appropriate.
5. Press the ENTER soft key.
6. Press the [MENU] key to close the menu.

## 2.14 Rejecting Radar Interference

Radar interference may occur when near another shipborne radar that is operating in the same frequency band as your radar. Its on-screen appearance looks like many bright dots either scattered at random or in the form of dotted lines extending from the center to the edge of the display. Interference effects are distinguishable from normal echoes because they do not appear in the same place on successive rotations of the scanner.

Be sure to turn off the interference rejector when no interference exists – weak targets may be missed.

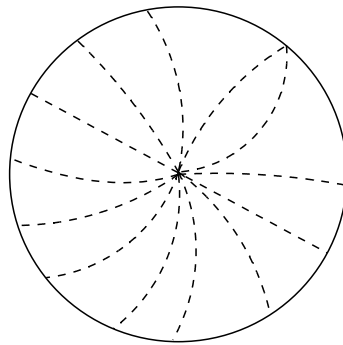

*Radar interference*

1. If not displayed, press the [HIDE/SHOW] key to show the radar soft keys.
2. Press the SIGNAL PROC. soft key.

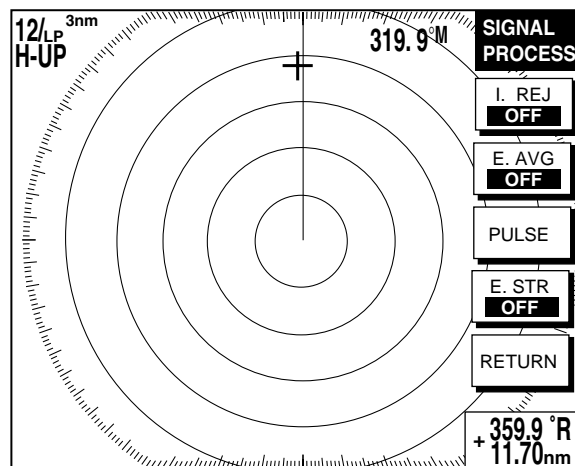

Shown when radar source is the Model 1800/1900 series radar. Not shown otherwise.

*SIGNAL PROCESS soft keys*

3. Press the I. REJ soft key successively to choose the interference rejection level desired; LOW, MED, HIGH or OFF.
4. Press the RETURN soft key to finish.

The display shows IR L (Low), IR M (Medium) or IR H (High) when the interference rejector is on.

## 2.15 Zoom

The zoom feature allows you to double the size of the area selected with the “zoom circle.” It is available on any range but is inoperative in true motion and when the display is shifted.

### 2.15.1 Zooming in on radar targets

1. If not displayed, press the [HIDE/SHOW] key to show the radar soft keys.
2. Use the trackball to set the cursor where you want to zoom.
3. Press the ZOOM & D. BOX soft key to show ZOOM & D. BOX soft keys.
4. Press the ZOOM ON/OFF soft key to select ON. A solid circle, called the “zoom circle,” appears on the display.
5. To release the cursor, press the CURSOR FLOAT soft key. (The solid circle changes to a dashed one.) To relocate the zoom circle, select location with the trackball, then press the CURSOR LOCK key.
6. To quit the zoom function, press the ZOOM ON/OFF soft key to select OFF.

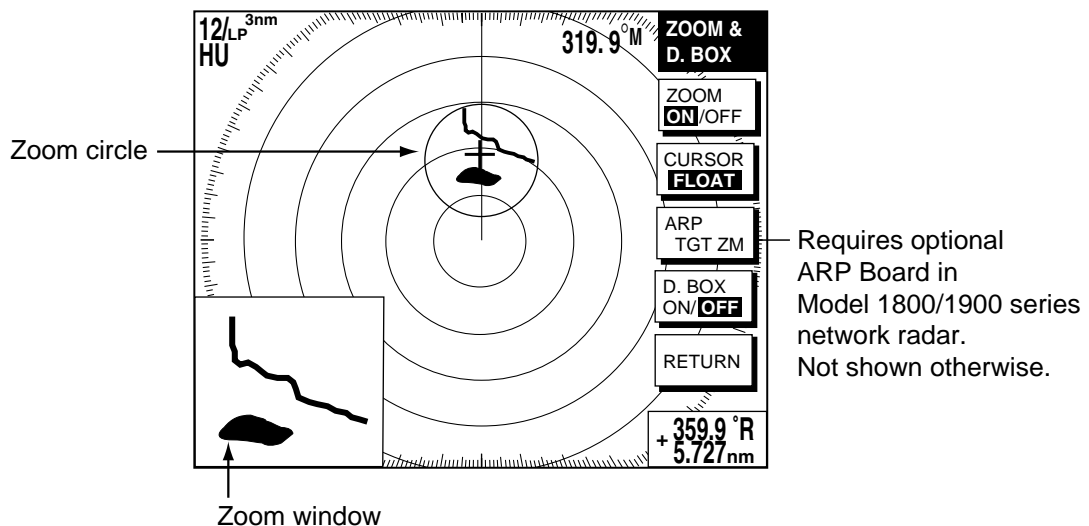

*Zoom*

### 2.15.2 Zooming in on ARP, TTM targets

You may zoom in on TTM (Tracked Target Message) and ARP targets. TTM targets can come from a NavNet connected radar, or from other ARP radar that is outputting the TTM message. (TTM is a NMEA 0183 data sentence that is an available output from some ARP capable radar.) Target numbers must be turned on to use this function. This can be done by enabling the target ID number option in the ARP SETUP menu.

1. If not displayed, press the [HIDE/SHOW] key to show the radar soft keys.
2. Press the ZOOM/D. BOX soft key to show ZOOM & D. BOX soft keys.
3. Press the ZOOM ON/OFF soft key to select ZOOM ON.

- Press the ARP TGT ZM soft key.

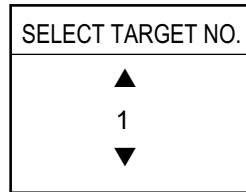

*Target no. selection window*

- Use the [ENTER] knob to select number (1-10), then push the [ENTER] knob. If the target number does not exist several beeps sound and the zoom function is cancelled.

To cancel, press the CURSOR LOCK soft key.

**Note:** The zoom window blends in with the background when the background color for the radar picture is white. If the window is difficult to see, change the background color.

## 2.16 Shifting the Picture

Own ship position, or sweep origin, can be displaced manually or automatically to expand the view field without switching to a larger scale.

### 2.16.1 Manual shift

The sweep origin can be shifted in any presentation mode to a point specified by the cursor by up to 50% of the range in use in any direction.

- Locate the cursor anywhere within the effective radius of the display.
- If not displayed, press the [HIDE/SHOW] key to show the radar soft keys.
- Press the RADAR DISPLY soft key.
- Press the SHIFT soft key.
- Press the MANUAL soft key to shift. The heading line shifts to the cursor location. SHIFT appears at right-hand corner of the display.
- To cancel shift, press the RADAR DISPLY, SHIFT and OFF soft keys.

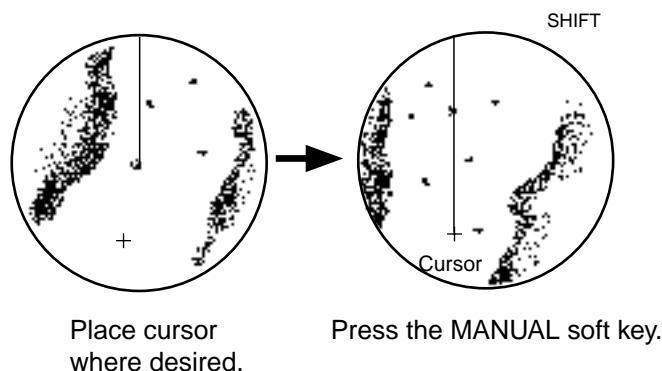

*Shifting the picture manually*

### 2.16.2 Automatic shift

The amount of automatic shift is calculated according to ship's speed, and the amount of shift is limited to 50% of the range in use. For example, if you set the shift speed setting for 15 knots and the ship is running at 10 knots the amount of shift will be about 34%. The formula for determining shift amount is as shown below.

$$\frac{\text{Ship's speed}}{\text{Shift speed setting}} \times 0.5 = \text{Amount of shift(\%)}$$

Automatic shift mode is only available in the head-up mode.

#### **Setting automatic shift maximum speed**

1. If not displayed, press the [HIDE/SHOW] key to show the radar soft keys.
2. Press the RADAR DISPLY soft key.
3. Press the SHIFT soft key to show the shift soft keys.
4. Press the AUTO S.SPD soft key to display the auto ship speed setting window.

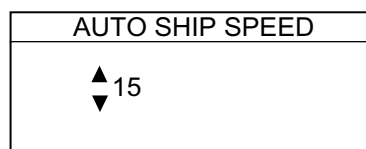

*Auto ship speed setting window*

5. Adjust the trackball or [ENTER] knob to set the maximum speed of your vessel, and then push the [ENTER] knob or the ENTER soft key to set. The setting range is 1-999 kt and the default setting is 15 kt.

#### **Automatic shift**

Press the AUTO key to automatically shift the sweep origin. To cancel shift, press the RADAR DISPLY, SHIFT and OFF soft keys.



## 2.17 Using the Offset EBL

The offset EBL can be used to predict a potential collision course. It can also be used to measure the range and bearing between two targets.

### 2.17.1 Predicting collision course

The procedure below may be used to check if a radar target is on a potential collision course with your vessel.

1. Press the [EBL/VRM] key to show the EBL/VRM soft keys.
2. Press the EBL1 ON soft key to turn on the EBL1.
3. Press the OFFSET soft key. The origin of EBL1 moves to the cursor position, which is marked with an "X."
4. Use the trackball to place the cursor on the radar target which looks like it might be on a collision course with own ship.
5. Push the [ENTER] knob to fix the origin position.
6. After waiting for a few minutes (at least three minutes), rotate the [ENTER] knob so the EBL bisects the target at the new position. If the target tracks along the EBL towards the center of the display (your ship's position), the target may be on a collision course with your vessel.
7. To cancel the offset EBL, press the OFFSET soft key.

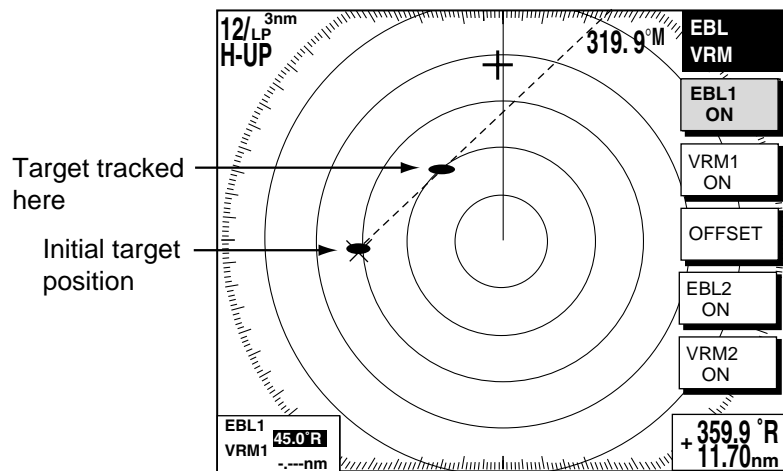

*Predicting collision course with the offset EBL*

### 2.17.2 Measuring range & bearing between two targets

The procedure which follows shows how to measure the range and bearing between two targets, using the targets “A” and “B” in the figure below as an example.

1. Operate the trackball to place the cursor on the target “A.”
2. Press the [EBL/VRM] key to show the EBL/VRM soft keys.
3. Press the EBL1 ON soft key to turn on the EBL1.
4. Press the OFFSET soft key. The origin of EBL1 moves to the cursor position, which is marked with an “X.”
5. Rotate the [ENTER] knob so the EBL bisects the target “B.”
6. Push the [ENTER] knob, then press the VRM1 ON soft key.
7. Rotate the [ENTER] knob to place the VRM1 on the inner edge of the target “B.”
8. Look at the indications for VRM1 and EBL1 to find the range and bearing between the two targets.
9. To cancel the offset EBL, press the OFFSET key.

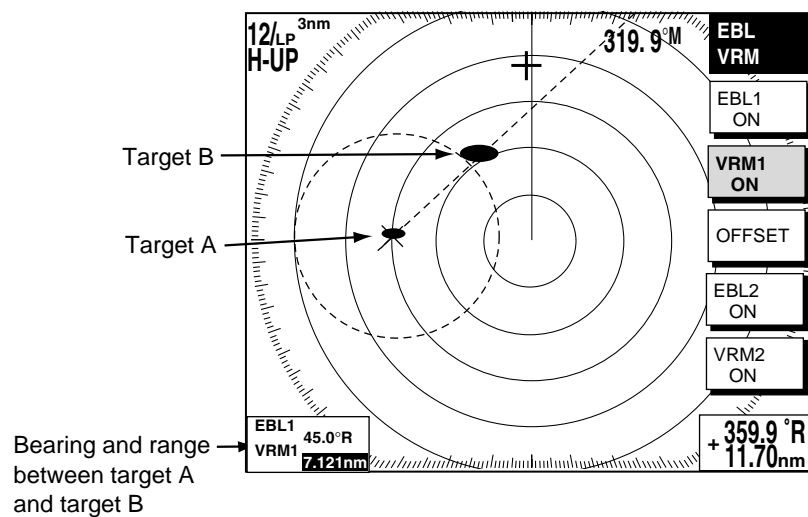

*Measuring range and bearing between two targets*

## 2.18 Echo Trails

Echo trails are simulated afterglow of target echoes that represent their movements relative or true to own ship. This function is useful for alerting you past possible collision situations.



*Sample echo trails*

### 2.18.1 Trail time

1. If not displayed, press the [HIDE/SHOW] key to show the radar soft keys.
2. Press the TARGET soft key.
3. Press the TRAIL soft key.

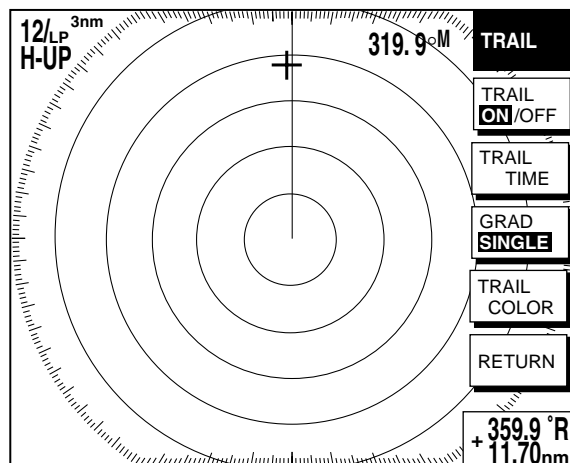

*Trail soft keys*

4. Press the TRAIL TIME soft key to show the trail time window.

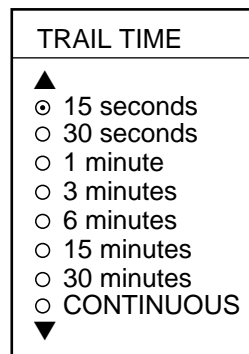

*Trail time window*

5. Use the trackball to select time desired.
6. Press the ENTER soft key.
7. Press the RETURN soft key twice to finish.

### 2.18.2 Starting echo trails

1. If not displayed, press the [HIDE/SHOW] key to show the radar soft keys.
2. Press the TARGET soft key.
3. Press the TRAIL soft key.
4. Press the TRAIL ON/OFF soft key to select ON.
5. Press the RETURN soft key twice to finish.

“TRAIL,” the echo trail time selected and elapsed time appear at the top right-hand corner of the display. Then, afterglow starts extending from all targets. Trails are restarted when the range or mode is changed and zoom or shift is turned on.

For continuous trails, the maximum continuous trail time is 99 minutes and 59 seconds. When the elapsed time clock counts up to that time, the elapsed time display resets to zero and trails begin again.

To turn off echo trail, press the TRAIL ON/OFF soft key to select OFF at step 4 in the above procedure.

### 2.18.3 Trail gradation

The echo trails can be shown in single or multiple gradations. Multiple gradation paints the trails thinner with time, like the afterglow on an analog PPI radar.

1. If not displayed, press the [HIDE/SHOW] soft key to show the radar soft keys.
2. Press the TARGET and TRAIL soft keys.
3. Press the GRAD soft key to select SINGLE or MULTI as appropriate.
4. Press the RETURN soft key twice to finish.



*Multitone and monotone trails*

### 2.18.4 Trail color

Trails may be shown target trails in blue, yellow, green or white.

1. If not displayed, press the [HIDE/SHOW] key to show the radar soft keys.
2. Press the TARGET, TRAIL and TRAIL COLOR soft keys in that order.

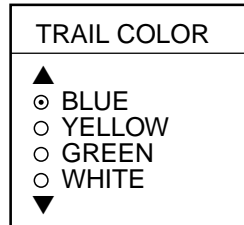

*Trail color window*

3. Use the trackball to select the color desired, then press the ENTER soft key.
4. Press the RETURN soft key twice.

### 2.18.5 Echo trail mode

Echo trails can be shown in Relative or True motion. (True trails require heading and speed inputs.)

1. Press the [MENU] key.
2. Press the RADAR DISPLAY SETUP key.
3. Choose TRAIL MODE, then press the EDIT soft key.

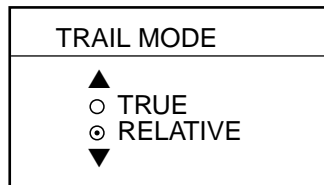

*Trail mode window*

4. Select TRUE or RELATIVE as appropriate, then press the ENTER soft key.
5. Press the [MENU] key to close the menu.

## 2.19 Echo Stretch

Normally, the reflected echoes from long range targets appear on the display as weaker and smaller blips even though they are compensated by the radar's internal circuitry. The echo stretch function magnifies these small blips in all ranges. Two types of echo stretch are available: ES LOW which stretches echoes in bearing direction and ES HIGH which stretches them in both range and bearing directions.

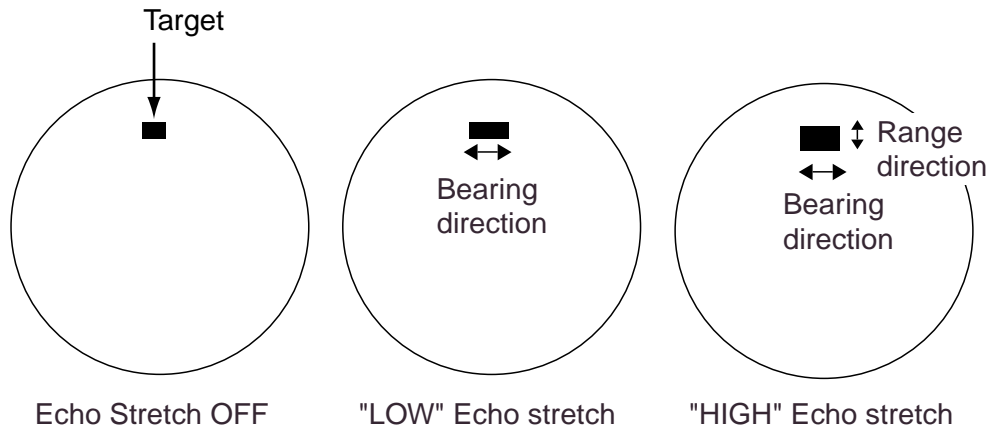

*Types of echo stretch*

This function magnifies not only targets but also sea clutter and radar interference. For this reason, be sure sea clutter and radar interference are properly suppressed before activating the echo stretch.

1. If not displayed, press the [HIDE/SHOW] key to show the radar soft keys.
2. Press the SIGNAL PROC. soft key.
3. Press the E. STR soft key to select HIGH, LOW or OFF as appropriate.
4. Press the RETURN soft key to finish.

The display shows ES H (High) or ES L (Low) when the echo stretch is on.

## 2.20 Echo Averaging

The echo average feature, which requires a Model 1800/1900 series network radar, effectively suppresses sea clutter. Echoes received from stable targets such as ships appear on the screen at almost the same position during every rotation of the antenna. On the other hand, unstable echoes such as sea clutter appear at random positions.

To distinguish real target echoes from sea clutter, echo average performs scan-to-scan correlation. Correlation is made by storing and averaging echo signals over successive picture frames. If an echo is solid and stable, it is presented in its normal intensity. Sea clutter is averaged over successive scans resulting in the reduced brilliance, making it easier to discriminate real targets from sea clutter.

To properly use the echo average function, it is recommended to first suppress sea clutter with the A/C SEA control and then do the following:

1. If not displayed, press the [HIDE/SHOW] key to display the radar soft keys.
2. Press the SIGNAL PROC. soft key.
3. Press the E. AVG soft key to select desired echo averaging.
  - OFF: No averaging
  - LOW: Helps distinguish targets from sea clutter and suppresses brilliance of unstable echoes.
  - MED: Distinguishes small stationary targets such as navigation buoys.
  - HIGH: Stably displays distant targets.
4. Press the RETURN soft key to finish.

The display shows EAV L, EAV M or EAV H when echo averaging is on.

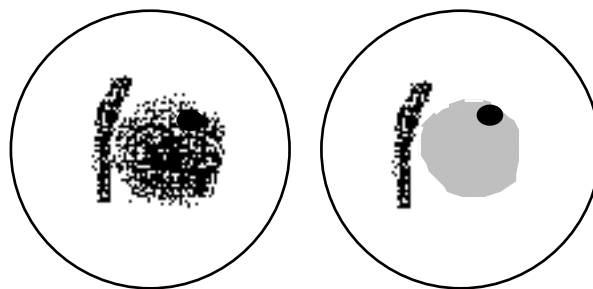

(a) Echo average OFF

(b) Echo average ON

*Effect of echo averaging*

## 2.21 Outputting TLL Data

Target position data can be output to units of the network and shown on their plotter screen with the TLL mark (⊗). This function requires position and heading data.

1. Operate the trackball to place the cursor on the target whose position you wish to output.
2. If not displayed, press the [HIDE/SHOW] key to display the radar soft keys.
3. Press the TARGET soft key.

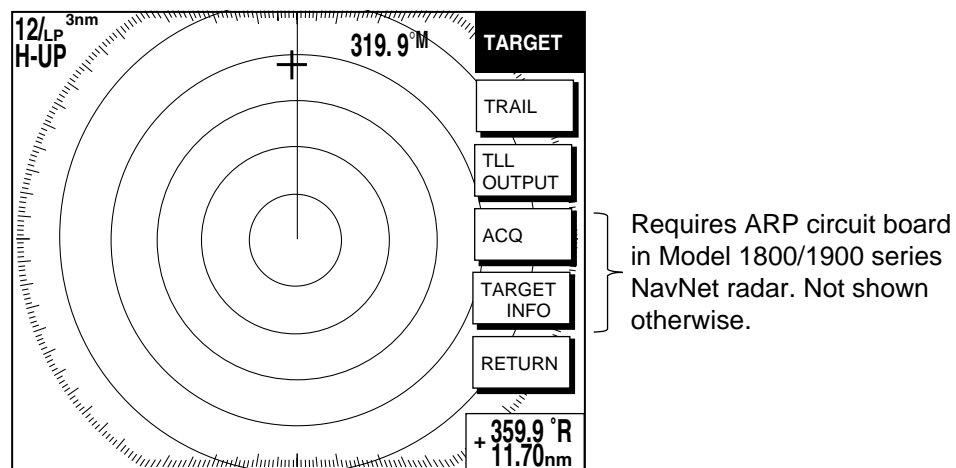

### TARGET soft keys

4. Press the TLL OUTPUT soft key to output target position data. The TLL mark appears on the plotter screen at the target's position the moment the TLL OUTPUT soft key was pressed. Further, that position is recorded as a waypoint on all NavNet units, under the youngest empty waypoint number on each NavNet unit.
5. Press the RETURN soft key to finish.

**Note:** The screen of the TLL recipient may be temporarily interrupted when receiving TLL from another NavNet display unit. Press any key to restore normal operation.



## 2.22 Guard Alarm

The guard alarm allows the operator to set the desired range and bearing for a guard zone. When ships, islands, landmasses, etc. violate the guard zone, an audio alarm sounds and the offending target blinks to call the operator's attention.

 <b>CAUTION</b>
<ul style="list-style-type: none"> <li>• The alarm should not be relied upon as the sole means for detecting possible collision situations.</li> <li>• A/C SEA, A/C RAIN and GAIN controls should be properly adjusted to be sure the alarm system does not overlook target echoes.</li> </ul>

### 2.22.1 Setting a guard alarm zone

To set a guard alarm zone, set the radar to transmit and do the following:

1. Press the [ALARM] key.
2. Use the trackball to set the cursor on the top left corner (or top right corner) of the guard zone you want to set, then press the SET GUARD1 or SET GUARD2 soft key, depending on which guard zone you want to set.
3. Use the trackball to set the cursor on the bottom right corner (or top left corner) of the guard zone area, then push the [ENTER] knob.
4. Press the RETURN soft key to finish.

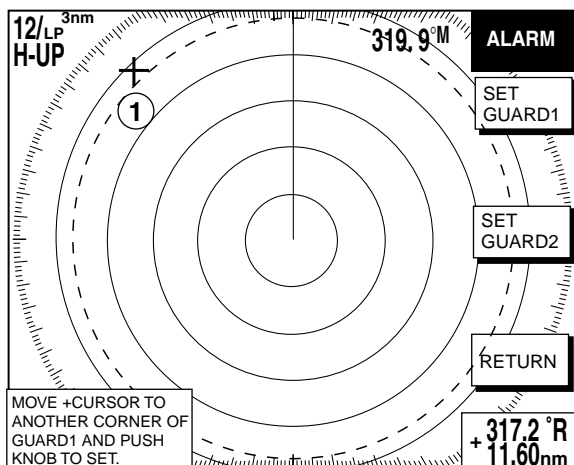

- (1) Drag cursor to top (or bottom) corner for guard zone and press the SET GUARD1 or SET GUARD2 soft key.

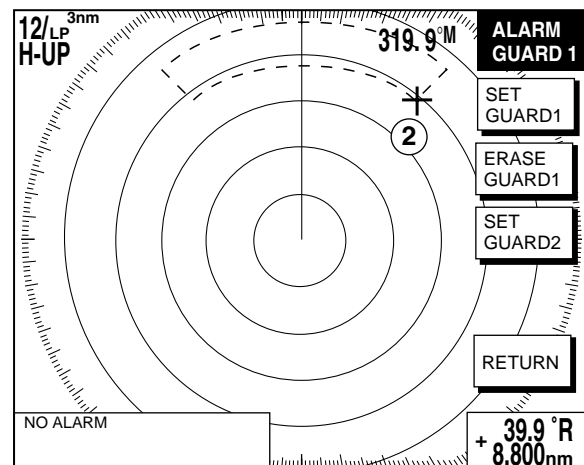

- (2) Drag cursor diagonally to bottom (or top) corner for guard zone and press the [ENTER] knob.

*How to set a guard alarm zone*

## 2. RADAR OPERATION

The equipment then searches for targets inside the guard zone to determine guard alarm type. If a target is found inside the guard zone, the guard zone type becomes an “Outward guard alarm,” and any target exiting the guard zone will trigger the audio alarm. If no target is found, the guard zone type becomes an “Inward guard alarm,” and any targets entering the guard zone will trigger the audio alarm. The guard alarm type is shown as G1(G2) IN or G1(G2) OUT.

**Note 1:** When the radar range is less than the guard zone range, the audio alarm sounds and the alarm icon appears (in red). Press the [CLEAR] key to silence the alarm. Press the [ALARM] key and the message “GUARD1(2) IS OUTSIDE RADAR RANGE” appears. Reselect appropriate range.

**Note 2:** If the network radar is set to standby while the guard alarm is active, the guard alarm is cancelled. The guard alarm is redisplayed when the radar is set to transmit again.

**Note 3:** If the network radar is set to standby while the radar picture is not displayed, the alarm icon appears in red and the alarm sounds. Press the [ALARM] key and the message “STBY MODE HAS BEEN SELECTED. GUARD/WTCHMN CANCELED.” or “GUARD/WATCHMAN CANCELED. STBY/TX SELECTED.” appears.

### 2.22.2 When the alarm is violated...

Any radar target violating the guard zone will flash, the audio alarm sounds, and the alarm icon appears in red. Additionally the message “TARGET ENTERED INTO GUARD1(GUARD2)” or “TARGET LEFT FROM GUARD1(GUARD2)” is displayed at the bottom of the screen. Press the [CLEAR] key to silence the alarm.

### 2.22.3 Cancelling the guard alarm

1. Press the [ALARM] key to show the ALARM menu.
2. Press the ERASE GUARD1 or ERASE GUARD2 soft key as appropriate.
3. Press the RETURN soft key to finish.

## 2.23 Watchman

### 2.23.1 How watchman works

The watchman function periodically transmits radar pulses for one minute to check for targets in a guard zone. If a target is found in the zone, watchman is cancelled, the audio alarm sounds and the radar continues transmitting. If no target is found the radar goes into standby for the number of minutes specified on the RADAR DISPLAY SETUP menu. This feature is useful when you do not need the radar's function continuously but want to be alerted to radar targets in a specific area. "WTCH" appears at the top left corner when Watchman is active.

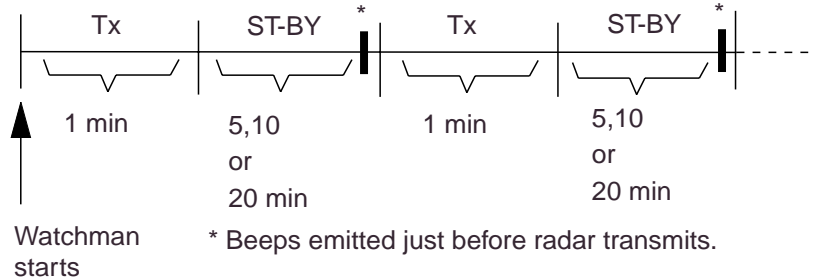

*How watchman works*

### 2.23.2 Turning on/off watchman

1. Set a guard zone. (See the paragraph 2.22.)
2. If not displayed, press the [HIDE/SHOW] key to display the radar soft keys.
3. Press the NAV FUNC soft key.
4. Press the W. MAN ON/OFF soft key to select ON or OFF as appropriate.
5. Press the RETURN soft key to finish.

**Note:** When the watchman is activated and no guard zone is active, the message "PLEASE SET GUARD ZONE. PUSH ANY KEY TO CONTINUE." appears. Press any key and then set a guard zone.

### 2.23.3 Setting watchman stand-by interval

The watchman standby interval, that is, the number of minutes the radar is in standby, can be set to 5, 10 or 20 minutes as follows:

1. Press the [MENU] key.
2. Press the RADAR DISPLAY SETUP soft key.
3. Select WATCHMAN TIME, then press the EDIT soft key.

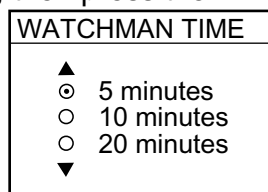

*Watchman window*

4. Select time desired, then press the ENTER soft key.
5. Press the [MENU] key to close the menu.

## 2.24 Suppressing Second-trace Echoes

In certain situations, echoes from very distance targets may appear as false echoes (second-trace echoes) on the screen. This occurs when the return echo is received one transmission cycle later, or after a next radar pulse has been transmitted.

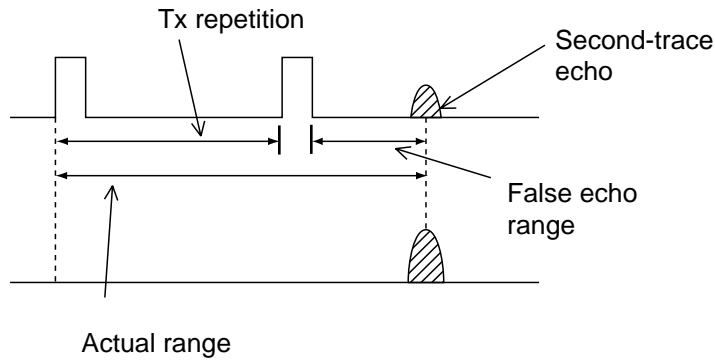

*Second-trace echoes*

To activate or deactivate the second-trace echo rejector do the following:

1. Press the [MENU] key.
2. Press the RADAR DISPLAY SETUP soft key.
3. Use the trackball to select 2ND ECHO REJECTION, then press the EDIT soft key.
4. Choose ON or OFF as appropriate, then press the ENTER soft key.
5. Press the [MENU] key to close the menu.

## 2.25 Waypoint Marker

A waypoint marker, showing the location of the destination waypoint set on the plotter, may be inscribed on the radar display.

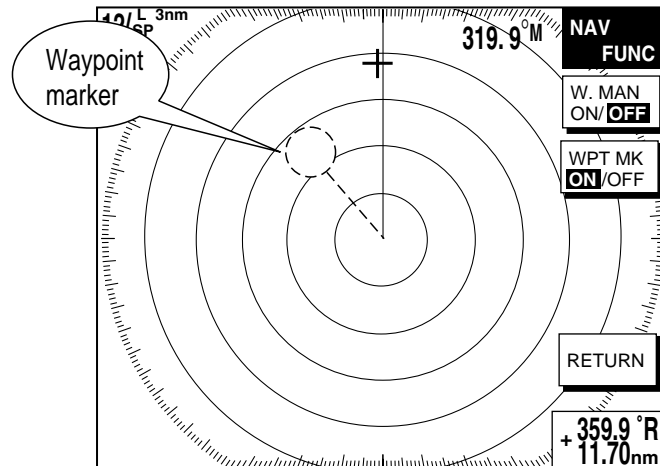

*Waypoint marker*

1. If not already shown, press the [HIDE/SHOW] key to display the radar soft keys.
2. Press the NAV FUNC soft key.
3. Press the WPT MK ON/OFF soft key to select ON or OFF as appropriate.
4. Press the RETURN soft key to finish.

## 2.26 ARP, TTM Operation

When the radar source is an ARP-equipped Model 1800/1900 series network radar, you can manually and automatically acquire and track ten targets. Once a target is acquired automatically or manually it is automatically tracked within 0.1 to 32 nm. If the FURUNO heading sensor PG-1000 is used, the data sentence "RMC" is necessary.

Alternatively, you can display the tracks of other ships by receiving the data sentence TTM (Tracked Target Message) via the NETWORK or NMEA port on the display unit. However, targets cannot be acquired.

**Note:** When using your unit as remote display, you cannot change the range of the main radar at the remote display. For the target acquisition, set the range individually.

### Usage precautions for ARP

#### **WARNING**

**No one navigational aid should be relied upon for the safety of vessel and crew. The navigator has the responsibility to check all aids available to confirm position. Electronic aids are not a substitute for basic navigational principles and common sense.**

- This auto plotter automatically tracks an automatically or manually acquired radar target and calculates its course and speed, indicating them by a vector. Since the data generated by the auto plotter are based on what radar targets are selected, the radar must always be optimally tuned for use with the auto plotter, to ensure required targets will not be lost or unwanted targets such as sea returns and noise will not be acquired and tracked.
- A target does not always mean a land-mass, reef, ships or other surface vessels but can imply returns from sea surface and clutter. As the level of clutter changes with environment, the operator should properly adjust the A/C SEA, A/C RAIN and GAIN controls to be sure target echoes are not eliminated from the radar screen.

#### **CAUTION**

**The plotting accuracy and response of this auto plotter meets IMO standards. Tracking accuracy is affected by the following:**

- Tracking accuracy is affected by course change. One to two minutes is required to restore vectors to full accuracy after an abrupt course change. (The actual amount depends on gyrocompass specifications.)
- The amount of tracking delay is inversely proportional to the relative speed of the target. Delay is on the order of 15-30 seconds for high relative speed; 30-60 seconds for low relative speed.

**Display accuracy is affected by the following:**

- Echo intensity
- Radar transmission pulsewidth
- Radar bearing error
- Gyrocompass error
- Course change (own ship or target)

### 2.26.1 Activating/deactivating ARP, TTM

1. Press the [MENU] key followed by the ARP SETUP soft key to show the ARP SETUP menu.

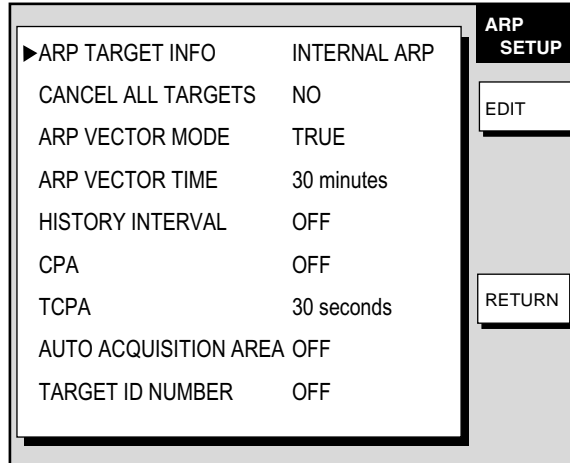

*ARP setup menu*

2. Select ARP TARGET INFO, then press the EDIT soft key to show the ARP target info window.

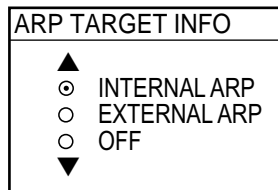

*ARP target info window*

3. Select INTERNAL ARP, EXTERNAL ARP or OFF as appropriate.

**INTERNAL ARP:** The radar source must be an ARP-equipped Model 1800/1900 series NavNet radar. Select this item also for a NavNet unit being fed ARP targets.

**EXTERNAL ARP:** Receive TTM data sentence via NMEA or NETWORK port. Target tracks are shown but targets cannot be acquired.

**OFF:** Turns off the ARP or TTM display.

4. Press the ENTER soft key.
5. Press the [MENU] key to close the menu.

## 2.26.2 Acquiring and tracking targets (ARP)

Ten targets may be acquired and tracked manually and automatically. When you attempt to acquire an 11th target, the message “ARP FULL – ALREADY TRACKING 10 TARGETS!” appears for five seconds. To acquire another target, terminate tracking of an unnecessary target as shown in the paragraph “2.26.4 Terminating tracking of ARP targets.”

### Manual acquisition

1. If not already shown, press the [HIDE/SHOW] key to show the radar soft keys.
2. Press the TARGET soft key.
3. Place the cursor on the target to acquire.
4. Press the ACQ soft key.
5. Press the RETURN soft key to finish.

The plot symbol changes over time as below. A vector appears about one minute after acquisition, indicating the target’s motion trend.

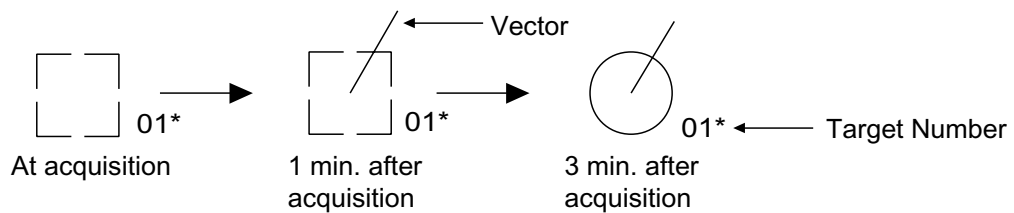

\* = Target number shown when TARGET ID NUMBER is turned on in the ARP SETUP menu.

*ARP plot symbols*

### Automatic acquisition

The ARP can acquire up to ten targets automatically by setting an automatic acquisition area. When automatic acquisition is selected after acquiring targets manually, only the remaining capacity for targets may be automatically acquired. For example, if seven targets have been manually acquired, three targets may be automatically acquired.

1. Press the [MENU] key to show the main menu.
2. Press the ARP SETUP soft key to show the ARP SETUP menu.
3. Operate the trackball to select AUTO ACQUISITION AREA.
4. Press the EDIT soft key to show the automatic acquisition area window.

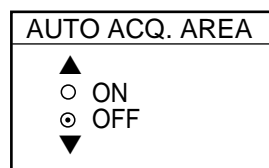

*Automatic acquisition area window*

5. Select ON, then press the ENTER soft key.



6. Press the [MENU] key to close the menu. An acquisition area of 2.0 to 2.5 miles in range and  $\pm 45^\circ$  on either side of the heading line in bearing appears.

**Note:** Targets being tracked in automatic acquisition are continuously tracked when switching to manual acquisition.

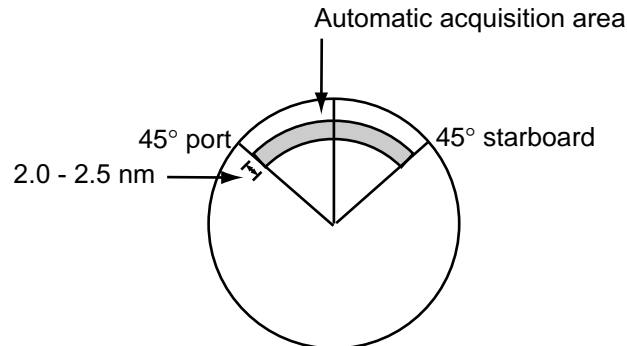

*Automatic acquisition area*

### 2.26.3 Displaying target number (ARP, TTM)

Target number can be shown for ARP and TTM targets as below.

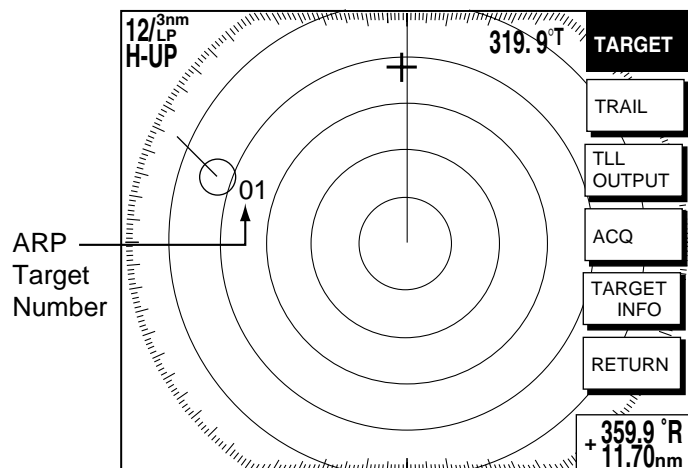

*ARP target number*

1. Press the [MENU] key.
2. Press the ARP SETUP soft key.
3. Select TARGET ID NUMBER.
4. Press the EDIT soft key.
5. Select ON or OFF as appropriate.
6. Press the ENTER soft key.
7. Press the [MENU] key to close the menu.

### 2.26.4 Terminating tracking of ARP targets

When ten targets have been acquired, no more acquisition occurs unless targets are cancelled. If you need to acquire additional targets, you must first cancel one or more individual targets, or all targets, using one of the procedures below.

#### Terminating tracking of selected targets

1. Place the cursor on the target to terminate tracking.
2. Press the [CLEAR] key to terminate tracking and erase the target.

#### Terminating tracking of all targets

1. Press the [MENU] key followed by the ARP SETUP soft key.
2. Select CANCEL ALL TARGETS.
3. Press the EDIT soft key.



*Cancel all targets window*

4. Select YES.
5. Press the ENTER soft key.
6. Press the RETURN soft key followed by the [MENU] key to close the menu.

## 2.26.5 Setting vector attributes (ARP)

### What is a vector?

A vector is a line extending from a tracked target which shows estimated speed and course of the target. The vector tip shows an estimated position of the target after the selected vector time elapses. It can be useful to extend the vector length (time) in order to evaluate the risk of collision with any target.

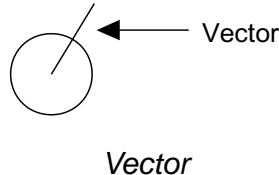

### Vector reference, vector time

You may reference the vectors to North (True, requires heading and speed data) or ship's heading (relative) as desired. Vector time can be set to 30 seconds, 1, 3, 6, 15 or 30 minutes.

1. Press the [MENU] key followed by the ARP SETUP soft key to show the ARP SETUP menu.
2. Operate the trackball to select ARP VECTOR MODE.
3. Press the EDIT soft key to show the ARP vector mode window.

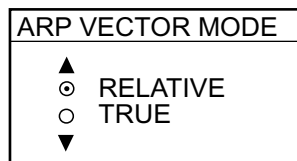

*ARP vector mode window*

4. Select TRUE or RELATIVE as appropriate.
5. Press the ENTER soft key.
6. Select ARP VECTOR TIME, then press the EDIT soft key to show the ARP vector time window.

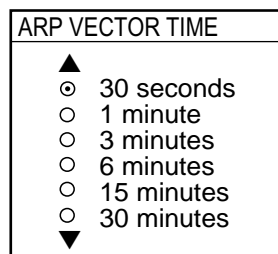

*ARP vector time window*

7. Operate the trackball to select vector time among 30 sec, 1 min, 3 min, 6 min, 15 min and 30 min.
8. Press the ENTER soft key.
9. Press the [MENU] key to close the menu.

### 2.26.6 Displaying past position (ARP)

This ARP can display time-spaced dots (maximum ten dots) marking the past positions of any targets being tracked. You can evaluate a target's actions by the spacing between dots. Below are examples of dot spacing and target movement.

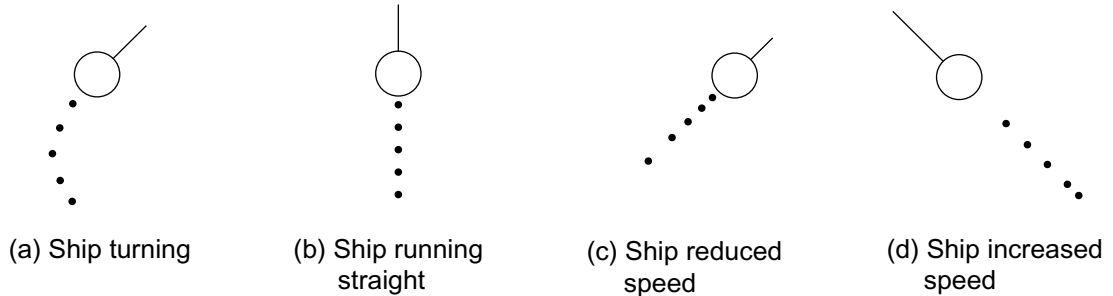

*Past position displays*

To turn the past position display on or off:

1. Press the [MENU] key followed by the ARP SETUP soft key.
2. Operate the trackball to select HISTORY INTERVAL.
3. Press the EDIT soft key to show the history interval window.

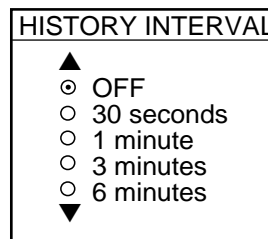

*History interval window*

4. Operate the trackball to select history interval among 30 sec, 1 min, 3 min and 6 min, or select OFF to turn off the past position display.
5. Press the ENTER soft key.
6. Press the [MENU] key to close the menu.

### 2.26.7 ARP, TTM target data

You can show motion trends (range, bearing, course, speed, CPA and TCPA) for ARP or TTM targets. Note that TARGET ID NUMBER, in the ARP SETUP menu, must be turned on to display this data.

1. Place the cursor on the target whose data you want to see.
2. If not already displayed, press the [HIDE/SHOW] key to show the radar soft keys.
3. Press the TARGET and TARGET INFO soft keys. The data of the selected target appears at the bottom left-hand corner of the display. (If an EBL/VRM data box is displayed the ARP (TTM) data box will be under it.)
4. Press the RETURN soft key to finish.
5. To erase ARP/TTM target data, select the corresponding target with the cursor, then press the [CLEAR] key.

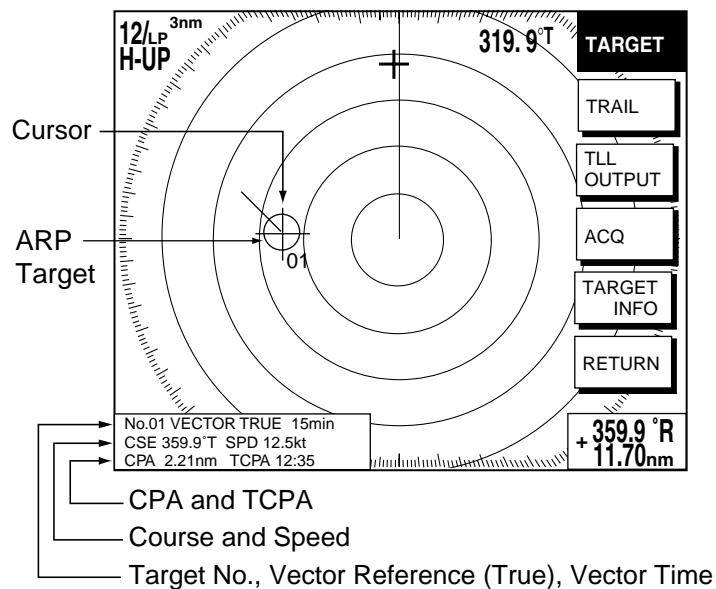

*ARP target data*

### 2.26.8 CPA/TCPA alarm (ARP)

When the predicted CPA of any target becomes smaller than a preset CPA alarm range or its predicted TCPA less than a preset TCPA alarm limit, an audio alarm sounds and the speaker icon appears (in red). In addition, the target plot symbol of the offending target changes to a triangle and flashes together with its vector. You may silence the audio alarm with the [CLEAR] key. Press the [ALARM] key and the message "COLLISION ALARM" appears. Press the CLEAR ALARM soft key to acknowledge the alarm. The flashing of the triangle plot symbol continues until you intentionally terminate tracking of the target. The ARP continuously monitors the predicted range at the Closest Point of Approach (CPA) and predicted time to CPA (TCPA) of each track to own ship.

This feature helps alert you to targets which may be on a collision course with own ship. However, it is important that gain, A/C SEA, A/C RAIN and other radar controls are properly adjusted and the ARP is set up so that it can track targets effectively.

CPA/TCPA alarm ranges must be set up properly taking into consideration the size, tonnage, speed, turning performance and other characteristics of own ship.

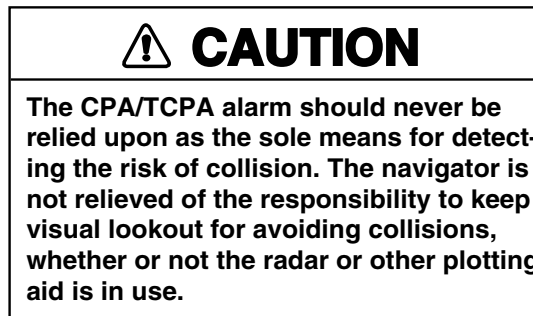

Follow the steps shown below to set the CPA/TCPA alarm range:

1. Press the [MENU] key followed by the ARP SETUP soft key.
2. Operate the trackball to select CPA.
3. Press the EDIT soft key to show the CPA window.

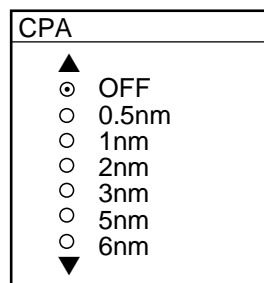

*CPA window*

4. Select a CPA limit desired from 0.5 nm, 1 nm, 2 nm, 3 nm, 5 nm and 6 nm with the trackball.
5. Press the ENTER soft key. The ARP SETUP menu reappears.
6. Operate the trackball to select TCPA.
7. Press the EDIT soft key to show the TCPA window.

TCPA	
▲	
⊙	30 seconds
○	1 minute
○	2 minutes
○	3 minutes
○	4 minutes
○	5 minutes
○	6 minutes
○	12 minutes
▼	

*TCPA window*

8. Select a TCPA limit from 30 sec, 1 min, 2 min, 3 min, 4 min, 5 min, 6 min and 12 min.
9. Press the ENTER soft key.
10. Press the [MENU] key to close the menu.

### 2.26.9 Lost target alarm (ARP)

When the system detects a lost target, the target symbol becomes a diamond and tracking is discontinued after one minute.

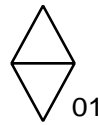
*Lost target mark*

#### **Canceling a lost target**

1. Place the cursor on the target.
2. Press the [CLEAR] key.

## 2.27 Interpreting the Radar Display

### 2.27.1 General

#### Minimum and maximum ranges

##### Minimum range

The minimum range is defined by the shortest distance at which, using a scale of 1.5 or 0.75 nm, a target having an echoing area of 10 m<sup>2</sup> is still shown separate from the point representing the antenna position. It is mainly dependent on the pulselength, antenna height, and signal processing such as main bang suppression and digital quantization. It is best to use the shortest possible range as long as the clarity and definition of the picture remain good.

##### Maximum range

The maximum detecting range of the radar, R<sub>max</sub>, varies considerably depending on several factors such as the height of the antenna above the waterline, the height of the target above the sea, the size, shape and material of the target, and atmospheric conditions.

Under normal atmospheric conditions, the maximum range is equal to the radar horizon or a little shorter. The radar horizon is longer than the optical one by about 6% because of the diffraction property of the radar signal. R<sub>max</sub> is given in the following equation.

$$R_{\max} = 2.2 \times (\sqrt{h_1} + \sqrt{h_2})$$

where            R<sub>max</sub>: radar horizon (nautical miles)  
                       h<sub>1</sub>: antenna height (m)  
                       h<sub>2</sub>: target height (m)

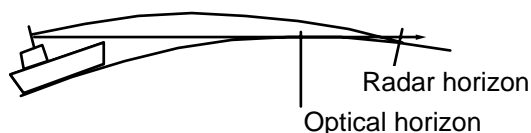

*Radar horizon*

For example, if the height of the antenna above the waterline is 9 meters and the height of the target is 16 meters, the maximum radar range is;

$$R_{\max} = 2.2 \times (\sqrt{9} + \sqrt{16}) = 2.2 \times (3 + 4) = 15.4 \text{ nm}$$

It should be noted that the detection range is reduced by precipitation (which absorbs the radar signal).



**Radar resolution**

There are two important factors in radar resolution (discrimination): bearing resolution and range resolution.

**Bearing resolution**

Bearing resolution is the ability of the radar to display the echoes received from two targets, which are at the same range and close together, as separate targets. Bearing resolution is directly proportional to the antenna length, and inversely proportional to the radar's wavelength.

**Range resolution**

Range resolution is the ability to display the echoes received from two targets, which are on the same bearing and close to each other, as separate targets.

**Bearing accuracy**

One of the most important features of the radar is how accurately the bearing of a target can be measured. The accuracy of bearing measurement basically depends on the narrowness of the radar beam. However, the bearing is usually taken relative to the ship's heading, and thus, proper adjustment of the heading marker at installation is an important factor in ensuring bearing accuracy. To minimize error when measuring the bearing of a target, select a range which will put the target as far out to the edge of the radar screen as possible.

**Range measurement**

Measurement of the range to a target is also a very important function of the radar. There are three means of measuring range: the fixed range rings, the trackball and the variable range marker (VRM). The fixed range rings appear on the screen with a predetermined interval and provide a rough estimate of the range to a target. The trackball is rolled to place the cursor on the leading edge of the target. Range and bearing to the target is shown at the bottom right-hand corner of the display. The variable range marker's diameter is increased or decreased so that the marker touches the inner edge of the target, allowing the operator to obtain more accurate range measurements.

### 2.27.2 False echoes

Occasionally echo signals appear on the screen at positions where there is no target or disappear even if there are targets. False target situations may be recognized, however, if you understand why they are displayed. Typical false echoes are shown below.

#### Multiple echoes

Multiple echoes occur when a transmitted pulse returns from a solid object like a large ship, bridge, or breakwater. A second, a third or more echoes may be observed on the display at double, triple or other multiples of the actual range of the target as shown below. Multiple reflection echoes can be reduced and often removed by decreasing the gain (sensitivity) or properly adjusting the [A/C SEA] control.

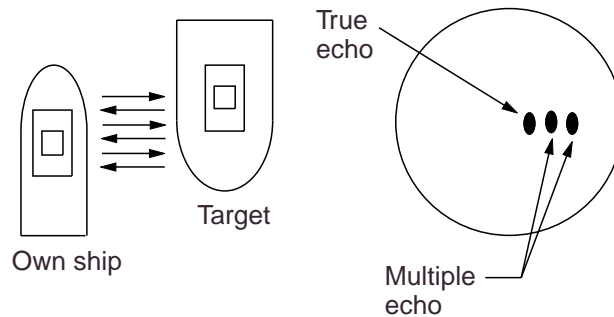

*Multiple echoes*

#### Sidelobe echoes

Every time the radar pulse is transmitted, some radiation escapes on each side of the beam. This stray RF is called a "sidelobe." If a target exists where it can be detected by the sidelobes as well as the main lobe, the side echoes may be represented on both sides of the true echo at the same range. Sidelobes show usually only on short ranges and from strong targets. They can be reduced through careful reduction of the gain or proper adjustment of the A/C SEA control.

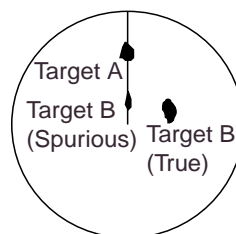

*Sidelobe echoes*

**Virtual image**

A relatively large target close to your ship may show at two positions on the screen. One of them is the true echo directly reflected by the target and the other is a false echo which is caused by the mirror effect of a large object on or close to your ship as shown in the figure below. If your ship comes close to a large metal bridge, for example, such a false echo may temporarily be seen on the screen.

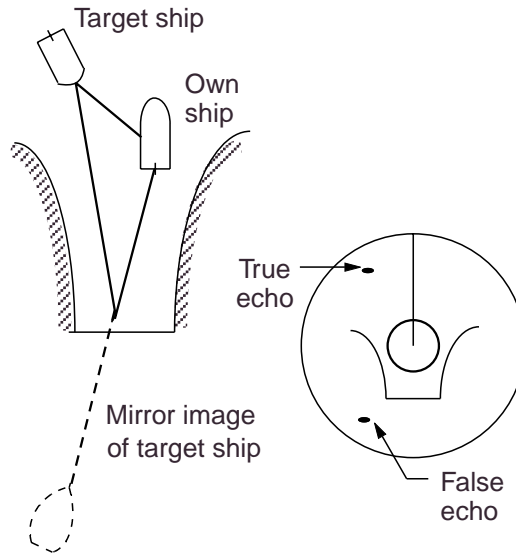
*Virtual image***Shadow sectors**

Funnels, stacks, masts, or derricks in the path of the antenna block the radar beam. If the angle subtended at the antenna is more than a few degrees, a non-detecting sector or blind spot may be produced. Within this sector, targets can not be detected.

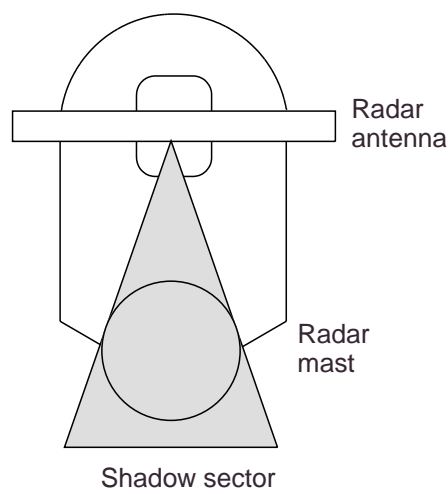
*Shadow sectors*

### 2.27.3 SART (Search and Rescue Transponder)

A Search and Rescue Transponder (SART) may be triggered by any X-Band (3 cm) radar within a range of approximately 8 nm. Each radar pulse received causes it to transmit a response which is swept repetitively across the complete radar frequency band. When interrogated, it first sweeps rapidly ( $0.4 \mu\text{s}$ ) through the band before beginning a relatively slow sweep ( $7.5 \mu\text{s}$ ) through the band back to the starting frequency. This process is repeated for a total of twelve complete cycles. At some point in each sweep, the SART frequency will match that of the interrogating radar and be within the pass band of the radar receiver. If the SART is within range, the frequency match during each of the 12 slow sweeps will produce a response on the radar display, thus a line of 12 dots equally spaced by about 0.64 nautical miles will be shown.

When the range to the SART is reduced to about 1 nm, the radar display may show also the 12 responses generated during the fast sweeps. These additional dot responses, which also are equally spaced by 0.64 nm, will be interspersed with the original line of 12 dots. They will appear slightly weaker and smaller than the original dots.

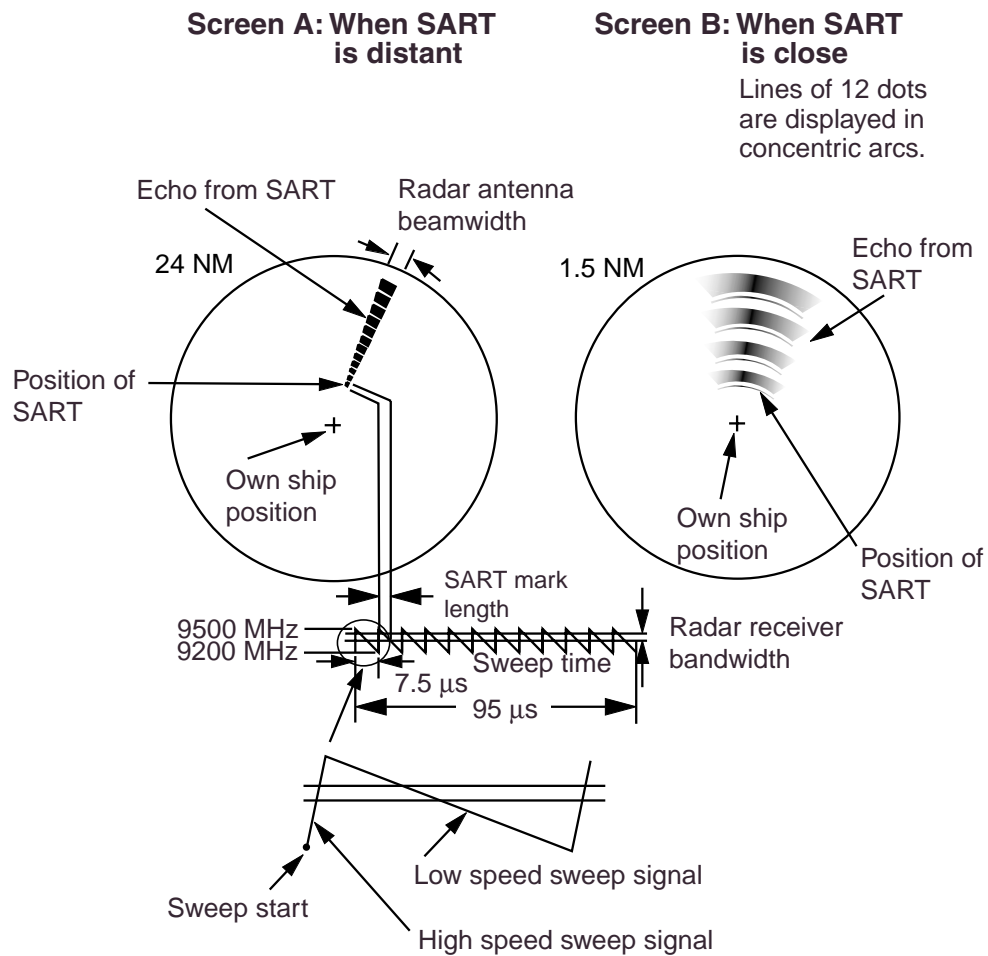

*Appearance of SART signal on the radar display*

**General procedure for detecting SART response**

1. Use the range scale of 6 or 12 nm as the spacing between the SART responses is about 0.6 nm (1125 m) to distinguish the SART.
2. Turn off the automatic clutter suppression (if applicable).
3. Turn off the Interference Rejector.

**General remarks on receiving SART****SART range errors**

When responses from only the 12 low frequency sweeps are visible (when the SART is at a range greater than about 1 nm), the position at which the first dot is displayed may be as much as 0.64 nm beyond the true position of the SART. When the range closes so that the fast sweep responses are seen also, the first of these will be no more than 150 meters beyond the true position.

**Radar bandwidth**

This is normally matched to the radar pulselength and is usually switched with the range scale and the associated pulselength. Narrow bandwidths of 3-5 MHz are used with long pulses on long range and wide bandwidths of 10-25 MHz with short pulses on short ranges.

Any radar bandwidth of less than 5 MHz will attenuate the SART signal slightly, so it is preferable to use a medium bandwidth to ensure optimum detection of the SART.

**Radar sidelobes**

As the SART is approached, sidelobes from the radar antenna may show the SART responses as a series of arcs or concentric rings. These can be removed by the use of the [A/C SEA] control although it may be operationally useful to observe the sidelobes as they may be easier to detect in clutter conditions and also they will confirm that the SART is near to the ship.

**Gain**

For maximum range SART detection the normal gain setting for long range detection should be used, that is, with background noise speckle visible.

## 2. RADAR OPERATION

### A/C SEA control

For optimum range SART detection, this control should be set to the minimum. Care should be exercised as wanted target in sea clutter may be obscured. Note also that in clutter conditions the first few dots of the SART response may not be detectable, irrespective of the setting of the anti-clutter sea control. In this case, the position of the SART may be estimated by measuring 9.5 nm from the furthest dot back towards own ship.

Some sets have automatic/manual anti-clutter sea control facilities in which case the operator should switch to manual.

### A/C RAIN control

This should be used normally (to break up areas of rain) when trying to detect a SART response which, being a series of dots, is not affected by the action of the anti-clutter rain circuitry. Note that racon responses, which are often in the form of a long flash, will be affected by the use of this control.

Some sets have automatic/manual anti-clutter rain control facilities in which case the operator should switch to manual.

**Note:** This SART information is excerpted from IMO SN/Circ 197 Operation of Marine Radar for SART Detection.

### 2.27.4 Racon (Radar Beacon)

A racon is a radar transponder which emits a characteristic signal when triggered by a ship's radar (usually only the 3 centimeter band). The signal may be emitted on the same frequency as that of the triggering radar, in which case it is superimposed on the ship's radar display automatically.

The racon signal appears on the PPI as a radial line originating at a point just beyond the position of the radar beacon or as a Morse code signal (see figure below) displayed radially from just beyond the beacon.

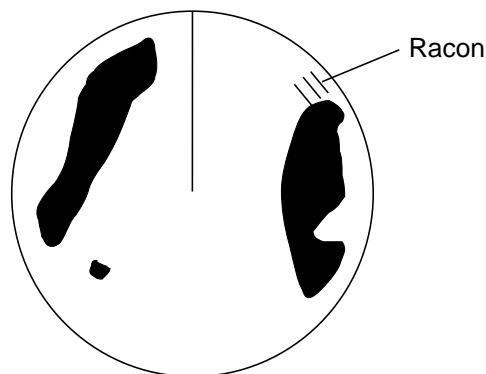

*Appearance of racon signal on the radar display*

# 3. PLOTTER OPERATION

## 3.1 Plotter Displays

You may show the plotter display over the entire screen, in the overlay screen with the radar display, or in a combination screen.

### 3.1.1 Full-screen plotter display

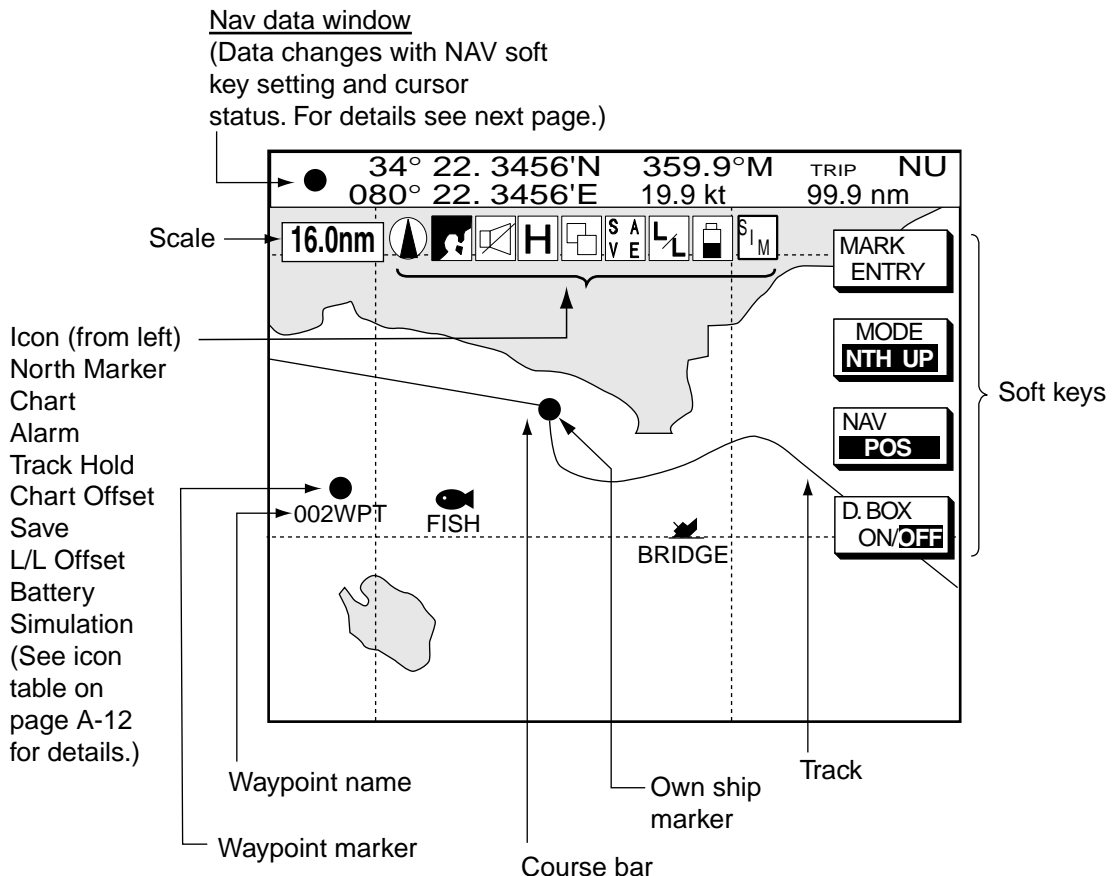

*Full-screen plotter display*

**Note:** When GPS signal error is found, the following occurs depending on the device feeding position data:

**GPS Receiver GP-310B/320B:** Alarm icon (☒) appears and the aural alarm sounds. Own ship marker blinks faster.

**Other navigator:** The message “NO GPS FIX” appears and is accompanied by the aural alarm and alarm icon. If the GPS signal is missing for more than 90 seconds, the message “NO POSITION DATA” appears.

**Nav data window**

The data shown in the nav data window depends on the status of the NAV soft key and the cursor.

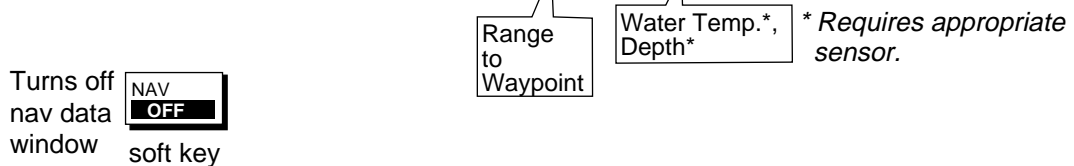
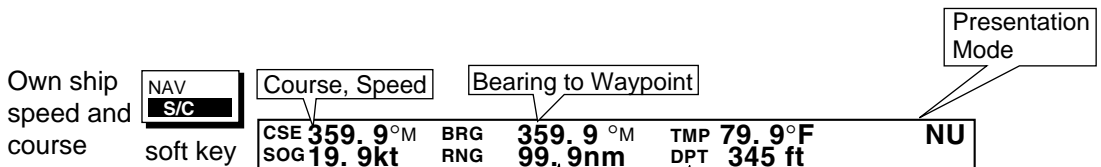
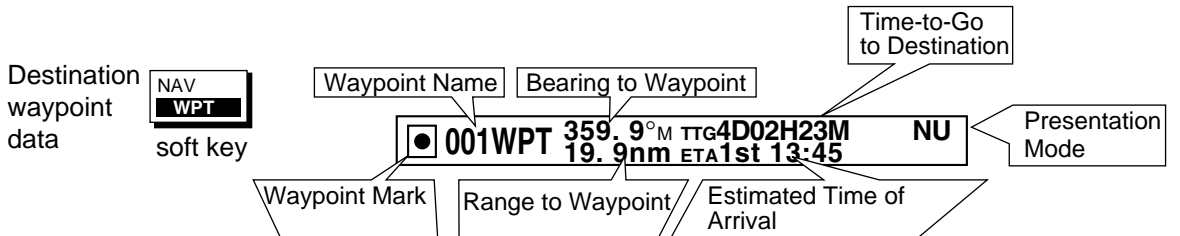
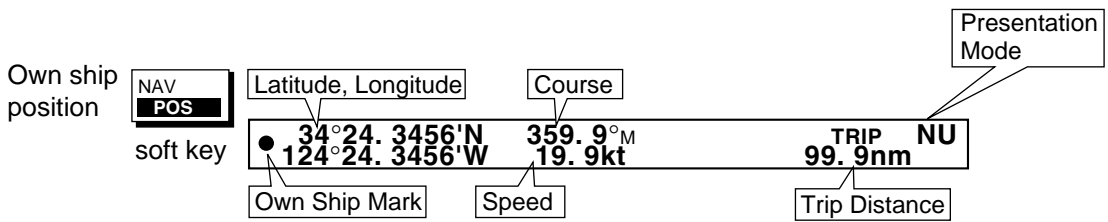
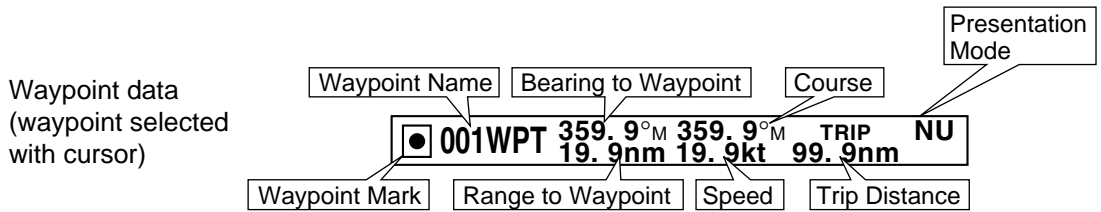
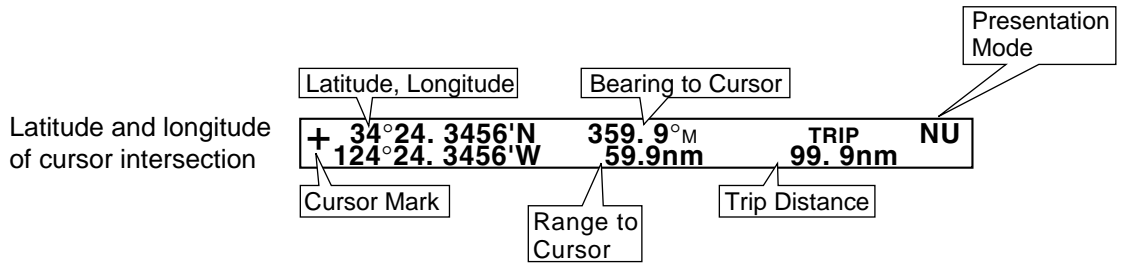

Contents of nav data window



### 3.1.2 Compass display

The compass display, shown in combination displays, provides steering information. The compass rose shows two triangles: the red triangle shows own ship's course and the black triangle, which moves with ship's course, shows the bearing to destination waypoint.

The water temperature and depth graphs, which require appropriate sensors, show the latest 10 minutes of water temperature and depth data. The range of the depth graph is 50 feet and it is automatically adjusted with depth.

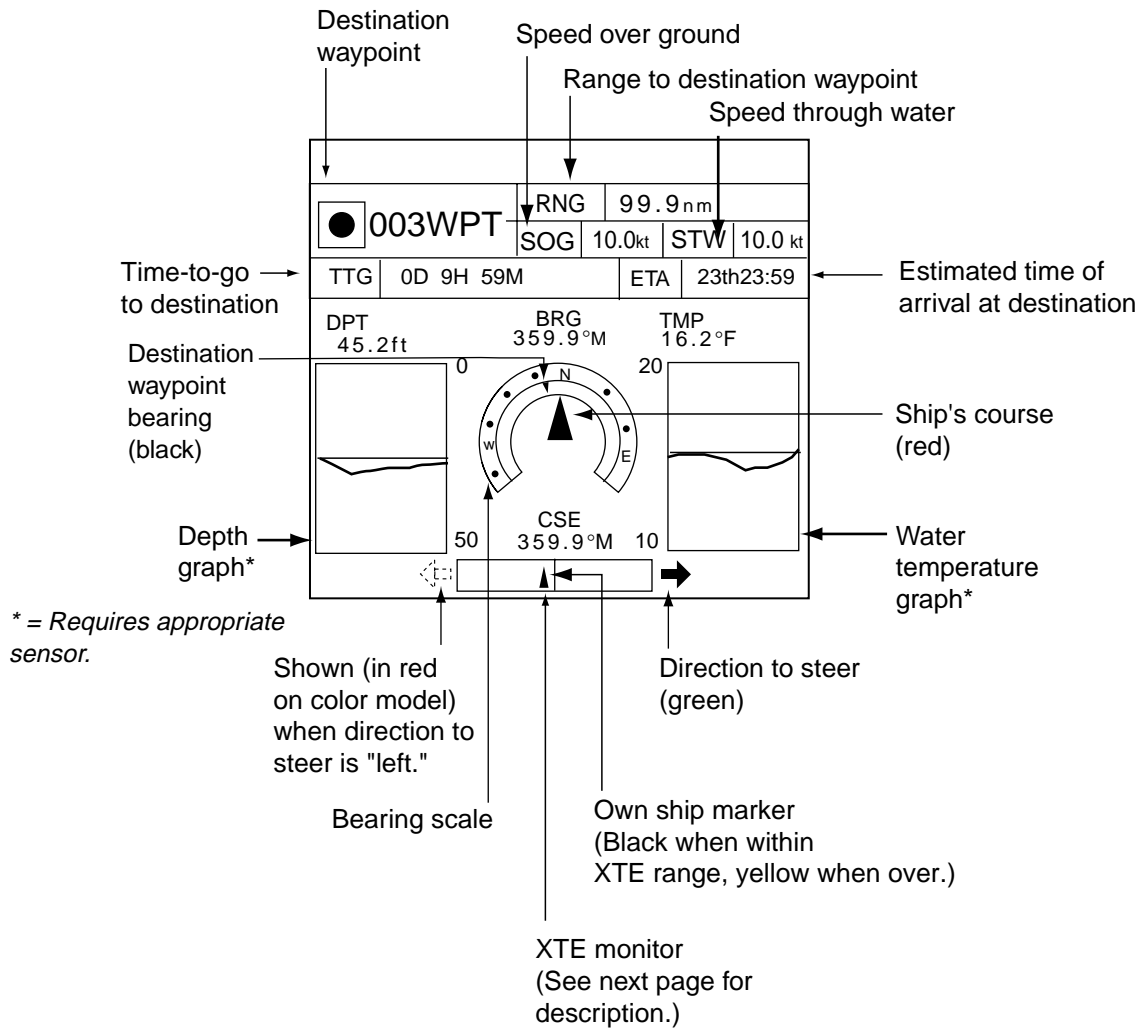

Compass display

**Reading the XTE (cross-track error) monitor**

The XTE monitor, located below the compass rose, shows the distance you are off course and the direction to steer to return to course. The own ship marker moves according to direction and distance off course. It is shown in black when the amount of cross-track error is within the XTE monitor range and yellow when it is over. An arrow appears at the right or left side of the XTE monitor and it shows the direction to steer to return to intended course. It is shown in red when you should steer left, and green when you should steer right. In the example on the previous page you would steer right to return to course. To maintain course, steer the vessel so the own ship marker stays at the center of the XTE monitor.

**Soft keys**

You can show the soft keys for the compass display by pressing the [HIDE/SHOW] key.

**COMPSS CNTRL:** On the radar/plotter/compass combination display you can switch control to the compass display by pressing the CNTRL soft key to select COMPSS.

**EDIT XT-LMT:** Sets the range for XTE monitor scale. See the procedure below for how to set.

**RESET XTE:** This soft key may be operated to restart navigation, when a destination is set. Press the EDIT XT-LMT soft key followed by the RESET XTE soft key. The following message is displayed.

RESTART NAVIGATION TO CURRENT WPT. ARE YOU SURE? YES ... PUSH ENTER KNOB NO ... PUSH CLEAR KEY
--

**Setting the range for the XTE monitor**

1. With the compass (or highway) display shown, press the EDIT XT-LMT soft key to display the following window.

XTE LIMIT
<b>0</b> .1nm

*XTE range setting window*

2. Use the trackball to select digit to change. Note that all digits may be cleared by pressing the [CLEAR] key.
3. Enter value with the alphanumeric keys.
4. Push the [ENTER] knob to set, or press the CANCEL soft key to cancel.

### 3.1.3 Highway display

The highway display, shown in combination displays, provides a graphic presentation of ship's track along intended course. It is useful for monitoring ship's progress toward a waypoint. The own ship marker shows the relation between ship and intended course. The XTE monitor shows the direction and amount your vessel is off course – the arrow shows the direction to steer to return to your course and the numeric the distance you are off course. Using the figure below as an example, you would steer right 0.009 nm to return to course. To maintain course, steer the vessel so the own ship marker stays aligned with the intended course line.

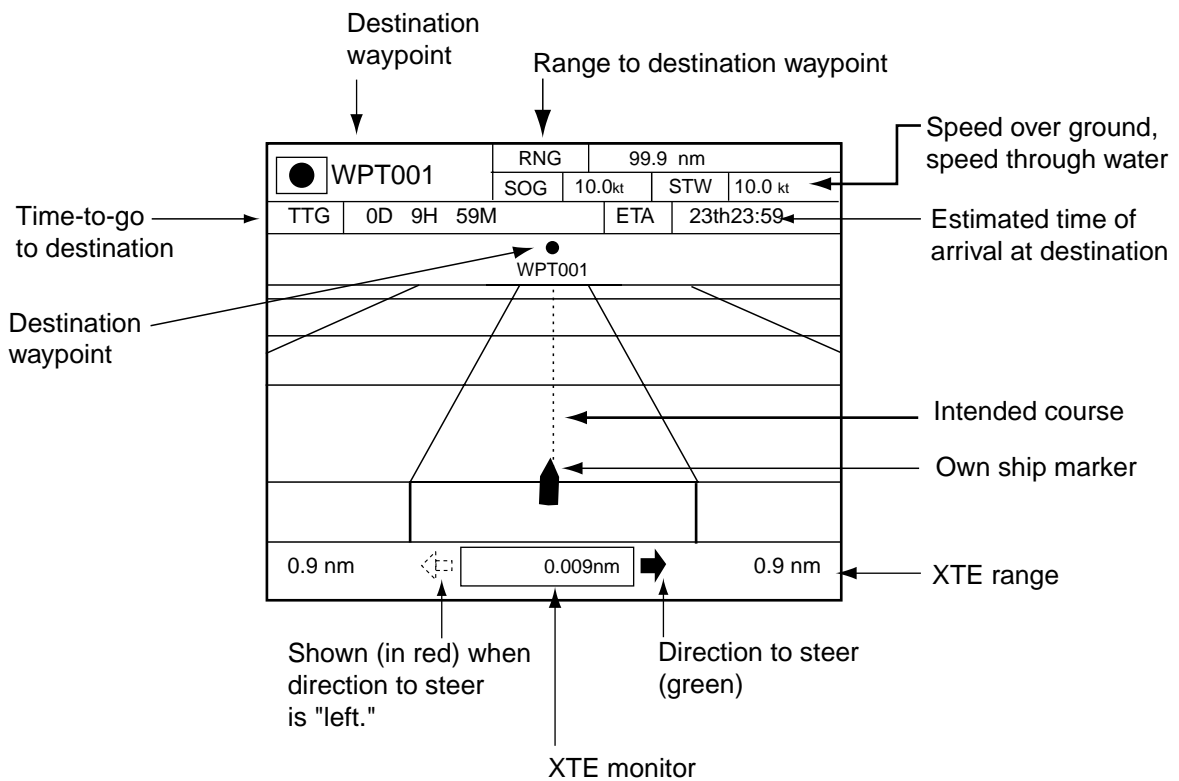

*Highway display*

#### **Soft keys**

You can show the soft keys for the highway display by pressing the [HIDE/SHOW] key.

**HIWAY CNTRL:** On the radar/plotter/compass combination display you can switch control to the highway display by pressing the CNTRL soft key to show HIWAY.

**EDIT XT-LMT:** Sets the range for XTE monitor scale. See the procedure on the previous page for how to set.

**RESET XTE:** This soft key may be operated to restart navigation, when a destination is set. Press the EDIT XT-LMT soft key followed by the RESET XTE soft key. See the previous page for details.

### 3.1.4 Nav data display

The nav data display provides comprehensive navigation data, and it is shown in a three-screen combination display. The user may select what data to display and where to display it. For details see the paragraph “5.8 Nav Data Display Setup.”

Appropriate sensors are required. Bars ( - - ) appear when corresponding sensor is not connected.

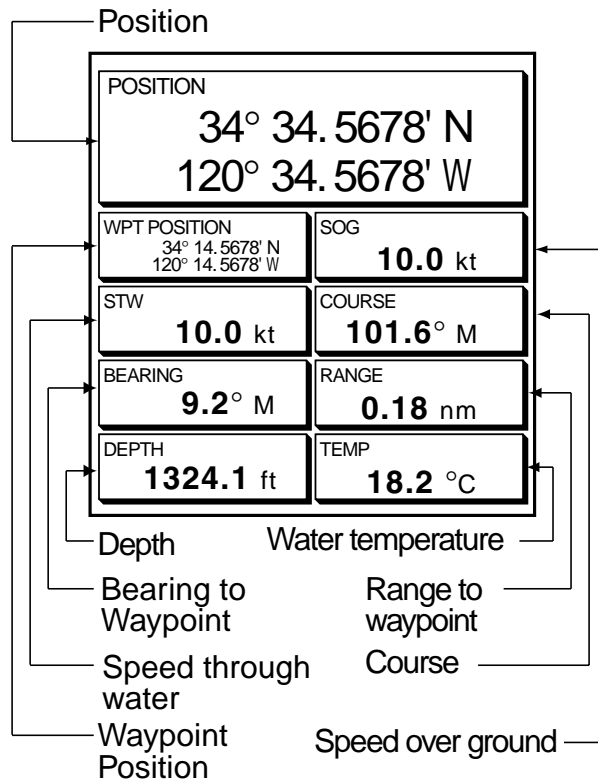

*Nav data displays*

## 3.2 Presentation Mode

Three types of presentation modes are provided for the plotter display: north-up, course-up and auto course-up. To change the presentation mode, press the [HIDE/SHOW] key followed by the MODE soft key. Each press of the key changes the presentation mode and presentation mode indication (top right-hand corner of the screen) cyclically in the sequence of North-up, Course-up and Auto course-up.

### 3.2.1 North-up

North (zero degree) is at the top of the display and own ship is shown with a filled circle. This mode is useful for long-range navigation.

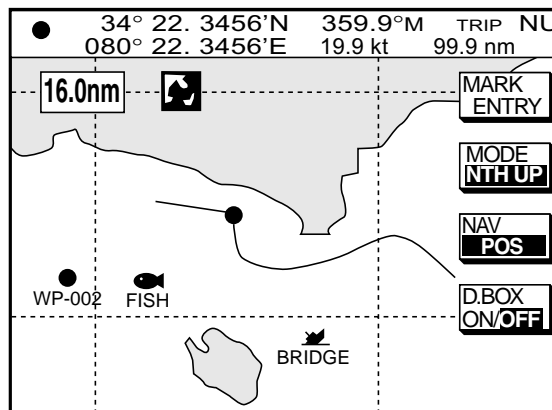

*Plotter display, north-up mode*

### 3.2.2 Course-up

The course-up mode is useful for monitoring ship's progress towards a waypoint. The destination is at the top of the screen when a destination is set. When no destination is set, the course or heading is at the top of the screen at the moment the course-up mode is selected. A filled triangle marks own ship's position.

**Note:** The data sentences GGA and VTG must be output from the NavNet display unit connected to the GPS navigator in order to correctly orient the own ship marker in the course-up mode on other NavNet display units.

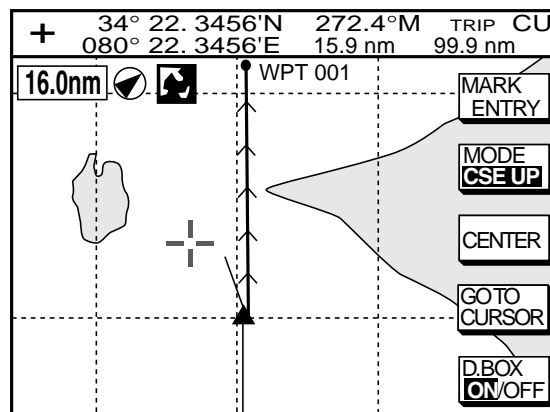

*Plotter display, course-up mode, destination set*

### 3.2.3 Auto course-up

The course is at the top of screen at the moment the auto course-up mode is selected. In this mode, the current course is kept at the top of the screen when the change is within 22.5 degrees. For example, if your vessel turns larger than 22.5 degrees to port or starboard, the chart display will rotate so that your course is pointing towards the top of the screen again. A filled triangle marks own ship's position.

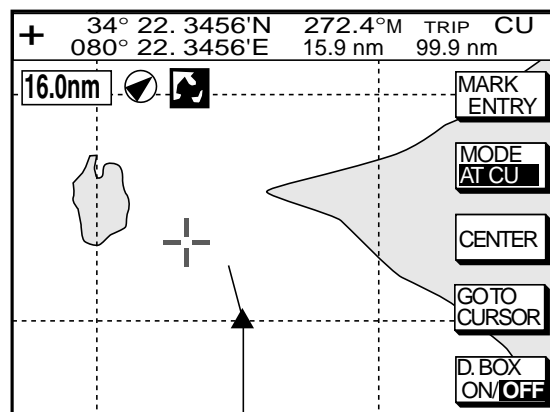

*Plotter display, auto course-up mode*

### 3.3 Shifting the Display

The plotter display can be shifted as below.

1. Use the trackball to locate the cursor at a screen edge. The screen shifts in the direction opposite of cursor location.
2. To turn off the cursor, press the CENTER soft key. This also returns the own ship marker to the screen center.

### 3.4 Chart Scale

Chart scale (range) may be selected with the [RANGE -] or [RANGE +] key. The [-] key expands the chart range; the [+] key shrinks it. The available ranges are as below.

Charts scales

nm	0.125	0.25	0.5	1	2	4	8	16	32	64	128	256	512	1024	2048
km	0.23	0.46	0.93	1.85	3.70	7.41	14.8	29.6	59.3	119	237	474	948	1896	3742
sm	0.144	0.29	0.58	1.15	2.30	4.60	9.21	18.4	36.8	73.7	147	295	589	1178	2356

**Note:** When the display is expanded or shrunk beyond the range of the chart card in use the message “NO CHART” appears, along with the appropriate chart icon. See the illustration on the next page for details.



## 3.5 Chart Cards

### 3.5.1 Chart card overview

Your system reads FURUNO and NavCharts™ (NAVIONICS) charts, or C-MAP charts, depending on the type of display unit you have.

When you insert a suitable chart card in the slot and own ship is near any cartographic object, a chart appears. If a wrong card is inserted or a wrong chart scale is selected, landmasses will appear hollow. Chart icons appear at the top of the display to help you select a suitable chart scale. The table below shows the chart icons and their meanings.

Chart icons and their meanings

Icon	Meaning
	Proper card is not inserted or chart scale is too small. Operate the RANGE key to adjust chart scale.
	Chart scale is too large. Operate the RANGE key to adjust chart scale.
	Suitable chart scale is selected.



### 3.5.2 Indices and chart enlargement

When the [RANGE] key is operated, you will see several frames appear on the chart. These frames are called indices and they show you what parts of the chart can be enlarged in the current range.

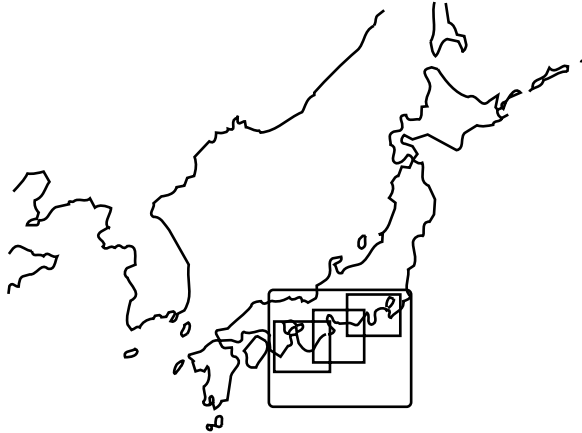

*Sample chart (Japan), showing indices*

#### **When a chart cannot be displayed**

A chart will not be displayed in the following conditions:

- When the chart scale is too large or too small.
- When scrolling the chart outside the indices.

When this happens, select proper chart scale.











**Note:** Indices can be turned on or off. For further details see “Chart border line” on page 5-14 for FURUNO and NAVIONICS charts and page 5-16 for C-MAP charts.

### 3.5.3 FURUNO and NavCharts™ charts

#### Chart symbols

The table below shows FURUNO and NavCharts™ chart symbols and their meanings.

*Chart symbols*

Symbol	Description	Symbol	Description
	Summit		Position of Sounding
	Wreck		Obstruction
	Lighthouse		Fishing Reef
	Lighted Buoy		Platform
	Buoy		Anchorage
	Radio Station		

#### Data for aids to navigation

Selected FURUNO and NavCharts™ charts can show buoy and lighthouse data. Simply place the cursor on the lighthouse or buoy mark.



Place the cursor on a lighthouse or buoy mark.

*Lighthouse mark*

Example of data displayed

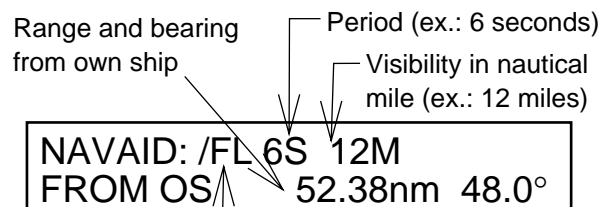

- FL : Flashing
- F : Fixed light
- F FL : Fixed and Flashing light
- MO : Morse code light
- Oc : Occulting light

*Example of buoy, lighthouse data*

**Port service icons**

Selected NavCharts show services available at ports, with icons.

1. Use the trackball to place the cursor on the sailboat icon (denotes a port or harbor) desired.
2. Push the [ENTER] knob.
3. Roll the trackball horizontally to select icon desired at the top of the display. The services available appear directly below the icon selected.
4. Press the RETURN soft key to finish.

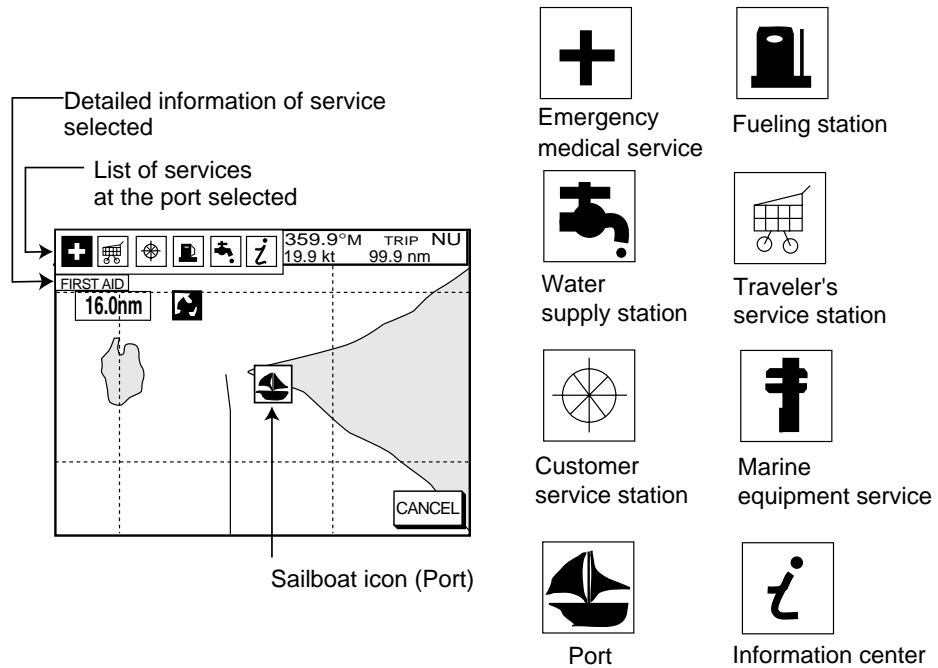

*Plotter display, showing port service display*

**Current (or tide) data**

Some NavCharts provide for calculation of the current (or tide) data for any date. Additionally it displays the time of sunrise and sunset, moon shape (on current data.)

1. Use the trackball to place the cursor on a current icon (☉).
2. Press the [ENTER] knob to show the current window.
3. Press the DATE soft key, and then enter the date desired.
4. Press the ENTER soft key.

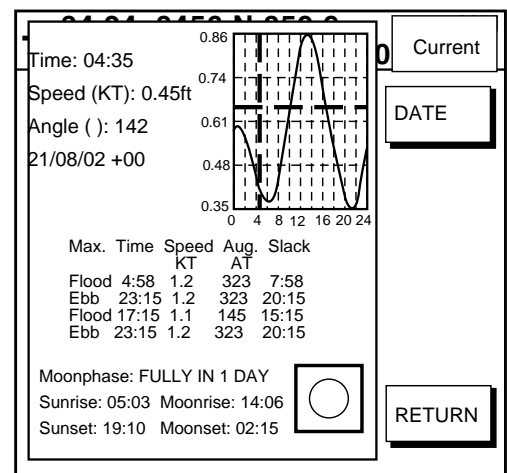

*Current data display*

### 3.5.4 C-MAP charts

#### Cursor and data display

Besides its fundamental functions of providing position data, the cursor can also show information about caution area, depth area, source of data, etc. on C-MAP charts. In addition, you can display information about an icon by placing the cursor on it.

1. Move the trackball to turn the cursor on.
2. Use the trackball to place the cursor on the position desired.
3. Push the [ENTER] knob to open the Objects window.

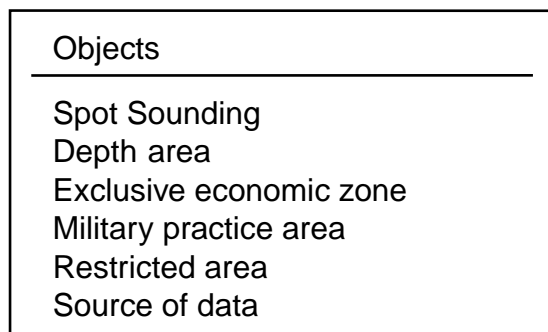

*Objects window*

4. Use the trackball to select the item desired.
5. Push the [ENTER] knob to display details for object selected.

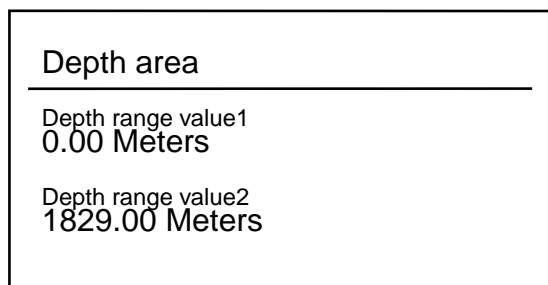

*Example of caution area window*

6. Press the CANCEL soft key to close the window.
7. Press the CANCEL soft key to finish.

**Icon data**

You may place the cursor on any icon to find information about the selected icon.

1. For example, place the cursor on a lighthouse icon.

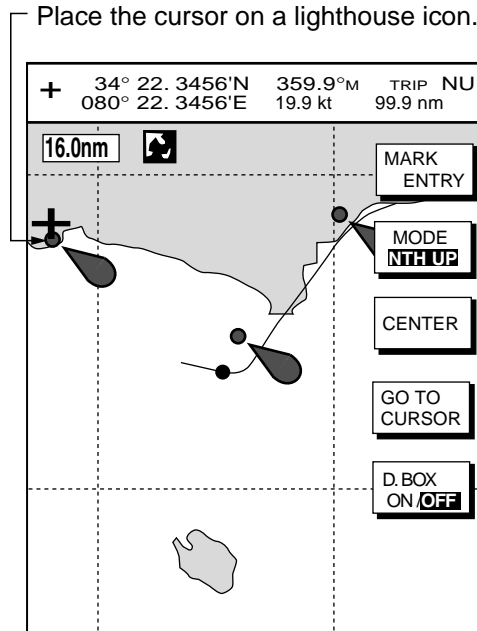

*Lighthouse icon*

2. Push the [ENTER] knob to show data. For example, the following window appears for a lighthouse.

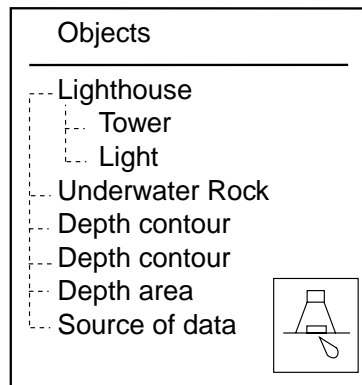

*Object windows*

3. Use the trackball to select the item desired.
4. Push the [ENTER] knob to display detailed information.

### 3. PLOTTER OPERATION

Navigation mark, fixed Light.
Color white
Height 7.00 Meters
Light characteristic occulting
XXXXXXXX
XXXXXXXX

#### *Sample lighthouse data*

5. If necessary, move the trackball downward or upward to scroll the window.
6. Press the CANCEL soft key twice to finish.

#### **Tide information**

The C-MAP NT chart card provides for calculation of the tide heights for any date. Additionally it displays the times of sunrise and sunset.

1. Use the trackball to place the cursor on a Tide icon (⬠).
2. Push the [ENTER] knob to open the Objects window.

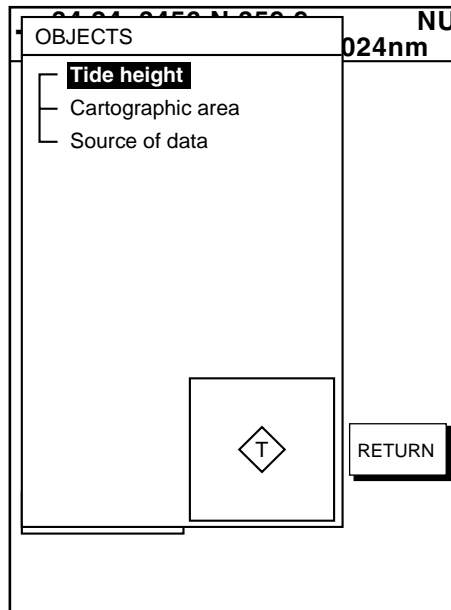

*Objects window*

3. Use the trackball to select Tide height.
4. Push the [ENTER] knob to open the TIDE window.

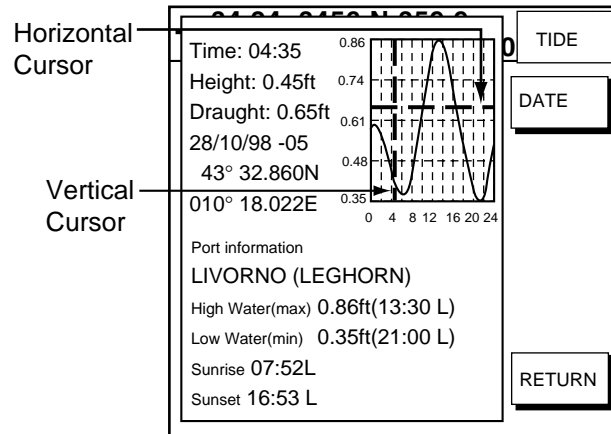
*Tide window*

5. Press the DATE soft key to open the DATE window.

CHANGE DATE
(DAY. MONTH. YEAR) 28. 10. 1998
LIMIT: 31.12.2099

*Date window*

6. Use the trackball to position the cursor where desired, then enter date with the alphanumeric keys. Repeat to enter complete date.
7. Push the [ENTER] knob to show the tidal graph for entered date.
8. Use the trackball to locate the vertical cursor on the hour desired.
9. Use the trackball to shift the horizontal cursor to select draught.
10. See the time, height and draught indications in left of the tide graph for tide information.
11. Press the CANCEL soft key twice to close the TIDE window.

### **Port service icons**

Selected C-MAP shows services available at ports, with lists.

1. Use the trackball to place the cursor on the sailboat icon (denotes a port or harbor) desired.
2. Push the [ENTER] knob.
3. Select the service name desired. The services available appear.
4. Press the CANCEL soft key.

Objects
--- Port area
--- Port/Marine
--- Fuel station
--- Water
--- Electricity
--- Showers
--- Pubric toilets
--- Pubric telephone

*C-map, port service display*

## 3.6 Working with Track

Your ship's track is plotted on the screen using navigation data fed from position-fixing equipment. This section shows you what you can do with track, from turning it on or off to changing its plotting interval. In the default setting, own ship's track is turned on and is displayed in red.

### 3.6.1 Displaying track

#### Own ship track

1. Press the [MENU] key followed by the CHART SETUP and TRACKS & MARKS CONTROL soft keys to open the TRACK CONTROL menu.

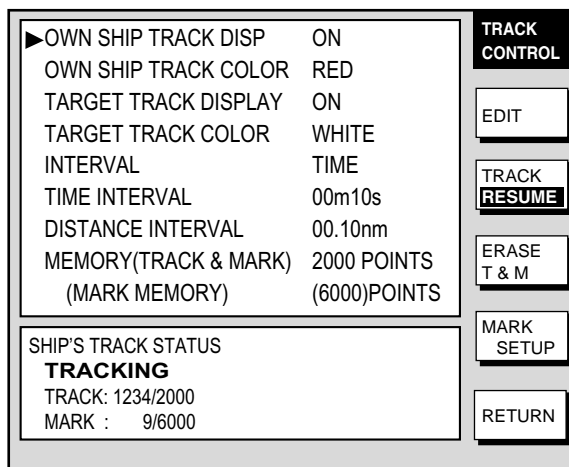

*Track control menu*

2. Use the trackball to select OWN SHIP TRACK DISP.
3. Press the EDIT soft key to show the track display window.
4. Use the trackball to select ON (default setting) or OFF as appropriate.
5. Press the ENTER soft key.
6. Press the [MENU] key to close the menu.

**Note:** The number of track and mark points used appears at the SHIP'S TRACK STATUS window on the TRACK CONTROL menu. Using the figure above as an example, 1234 points of track and 9 marks have been recorded.



### Target track

Target track, NMEA format TTM (Tracked Target Message) data sentence, may be turned on or off as desired. The default setting is ON.

1. Press the [MENU] key followed by the CHART SETUP and TRACKS & MARKS CONTROL soft keys to open the TRACK CONTROL menu.
2. Use the trackball to select TARGET TRACK DISPLAY.
3. Press the EDIT soft key to show the target track display window.
4. Use the trackball to select to ON (default setting) or OFF as appropriate.
5. Press the ENTER soft key.
6. Press the [MENU] key to close the menu.

### 3.6.2 Stopping, restarting plotting of own ship track

When your boat is at anchor or returning to port you probably won't need to record its track. You can stop recording the track, to conserve the track memory, as follows:

1. Press the [MENU] key followed by the CHART SETUP and TRACKS & MARKS CONTROL soft keys to open the TRACK CONTROL menu.

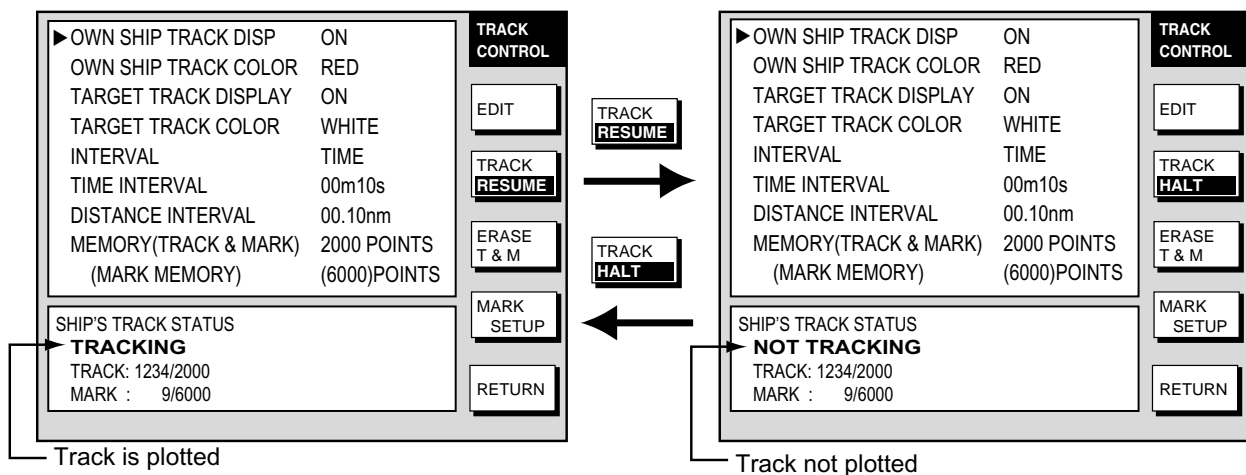

*Track control menu*

2. Press the TRACK RESUME soft key. The soft key now shows "TRACK HALT" and the indication "TRACKING" in the SHIP'S TRACK STATUS window changes to "NOT TRACKING." In addition, the icon "H" is displayed at the top of the plotter display and own ship marker becomes a hollow circle. To restart plotting the track, press the TRACK HALT soft key
3. Press the [MENU] key to close the menu.

### 3.6.3 Changing track color

Track can be displayed in red (default setting), yellow, green, light-blue, purple, blue and white. It can be useful to change track color on a regular basis to discriminate between previous day's track, etc.

#### Own ship's track

1. Press the [MENU] key followed by the CHART SETUP and TRACKS & MARKS CONTROL soft keys to open the TRACK CONTROL menu.
2. Use the trackball to select OWN SHIP TRACK COLOR.
3. Press the EDIT soft key to display the track color window.

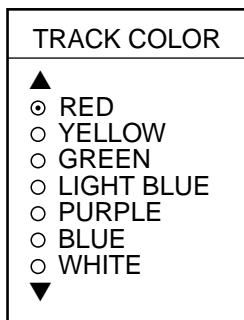

*Own ship track color window*

4. Use the trackball to select the color desired.
5. Press the ENTER soft key.
6. Press the [MENU] key to close the menu.

#### Target track

Like own ship's track, target tracks can be displayed in red, yellow, green, light-blue, purple, blue and white (default setting).

1. Press the [MENU] key followed by the CHART SETUP and TRACKS & MARKS CONTROL soft keys to open the TRACK CONTROL menu.
2. Use the trackball to select TARGET TRACK COLOR.
3. Press the EDIT soft key to display the track color window.
4. Use the trackball to select the color desired.
5. Press the ENTER soft key.
6. Press the [MENU] key to close the menu.

### 3.6.4 Track plotting method and interval for own ship track

In drawing the own ship track, first the ship's position fed from position-fixing equipment is stored into the unit's memory at an interval of time or distance. A shorter interval provides for better reconstruction of the track, but the storage time of the track is reduced. When the track memory becomes full, the oldest track is erased to make room for the latest.

#### Track plotting method

Track may be plotted by time or distance. The default setting is "time."

1. Press the [MENU] key followed by the CHART SETUP and TRACKS & MARKS CONTROL soft keys to open the TRACK CONTROL menu.
2. Use the trackball to select INTERVAL.
3. Press the EDIT soft key to display the plot window.

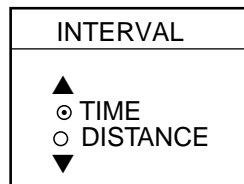

*Interval window*

4. Use the trackball to select TIME or DISTANCE as appropriate. Distance is useful for conserving track memory, since no track is recorded when the boat is stationary.
5. Press the ENTER soft key.
6. Press the [MENU] key to close the menu.

#### Track plotting interval

1. Press the [MENU] key followed by the CHART SETUP and TRACKS & MARKS CONTROL soft keys to open the TRACK CONTROL menu.
2. Use the trackball to select TIME INTERVAL or DISTANCE INTERVAL as appropriate.
3. Press the EDIT soft key to display the time or distance interval window, depending on what you selected at step 2.

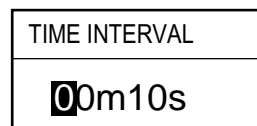

Setting range: 0 min 1 sec (continuous) - 99 min 59 sec  
Default setting: 10 sec

(When selecting TIME INTERVAL.)

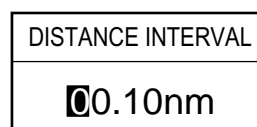

Setting range: 0.01 nm (continuous) - 99.99 nm (km, sm)  
Default setting: 0.1 nm

(When selecting DISTANCE INTERVAL.)

*Interval windows*

### 3. PLOTTER OPERATION

4. Use the trackball to select digit and enter value with the alphanumeric keys.  
The CLEAR soft key functions to clear an entire line of data.
5. Push the [ENTER] knob or ENTER soft key.
6. Press the [MENU] key to close the menu.

#### 3.6.5 Changing own ship track/mark distribution setting

The equipment stores a total of 8000 points of track and marks. This amount may be distributed as desired, and the default setting is 2000 points of track and 6000 points for marks.

When you change the track memory setting, all tracks and marks in the memory are erased. If necessary save the data to a memory card. For further details see the paragraph "6.1.2 Saving data to a memory card."

1. Press the [MENU] key followed by the CHART SETUP and TRACKS & MARKS CONTROL soft keys to open the TRACK CONTROL menu.
2. Use the trackball to select MEMORY (TRACK & MARK).
3. Press the EDIT soft key to display the track memory window.

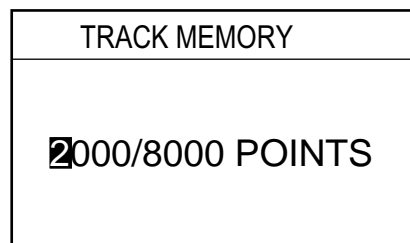

*Track memory window*

4. Use the trackball to select digit and use the alphanumeric keys to enter value.
5. Push the ENTER soft key or the [ENTER] knob. You are asked if you are sure to change the track memory capacity.
6. Push the [ENTER] knob.
7. Press the [MENU] key to close the menu.

### 3.6.6 Erasing track

This paragraph shows you how to erase own ship's track and target tracks. You can erase ship's track three ways: collectively, by color and by area.

#### Erasing own ship track by area

You can erase own ship's track by area as below. This feature is not available when the overlay mode is in use.

1. Press the [MENU] key followed by the CHART SETUP, TRACKS & MARKS CONTROL and ERASE T & M soft keys to show the ERASE menu.

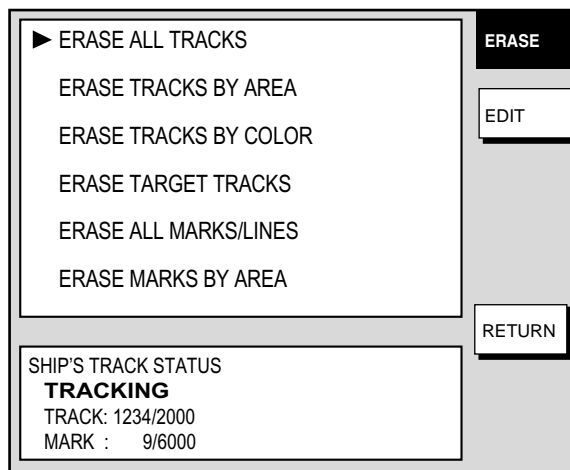

*Erase menu*

2. Use the trackball to select ERASE TRACKS BY AREA, then press the EDIT soft key. The menu is erased and the plotter display appears.
3. Use the trackball to place the cursor at the top left-hand corner of the area which you want to erase track from.
4. Press the START soft key or the [ENTER] knob.
5. Move the cursor to the bottom right-hand corner of the area which you want to erase track from.
6. Press the END soft key or the [ENTER] knob. You are asked if you are sure to delete the track.
7. Push the [ENTER] knob to delete the track selected.
8. Press the [MENU] key twice to close the menu.

**Erasing own ship track by color**

You may erase own ship's track by color as follows:

1. Press the [MENU] key followed by the CHART SETUP, TRACKS & MARKS CONTROL and ERASE T & M soft keys to show the ERASE menu.
2. Use the trackball to select ERASE TRACKS BY COLOR, then press the EDIT soft key.

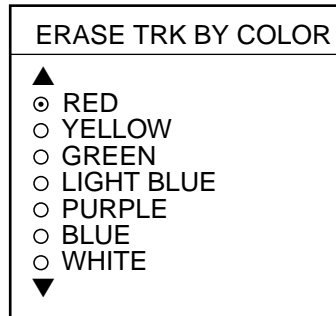

*Erase track by color window*

3. Use the trackball to select the color you want to erase, then push the [ENTER] knob.
4. Push the [ENTER] knob to erase the track color selected.
5. Press the [MENU] key twice to close the menu.

**Erasing all own ship track**

1. Press the [MENU] key followed by the CHART SETUP, TRACKS & MARKS CONTROL and ERASE T & M soft keys to show the ERASE menu.
2. Use the trackball to select ERASE ALL TRACKS, then press the EDIT soft key.
3. Push the [ENTER] knob to erase all own ship track.
4. Press the [MENU] key twice to close the menu.

**Erasing all target tracks**

1. Press the [MENU] key followed by the CHART SETUP, TRACKS & MARKS CONTROL and ERASE T & M soft keys to show the ERASE menu.
2. Use the trackball to select ERASE TARGET TRACKS, then press the EDIT soft key.
3. Push the [ENTER] knob to erase all target tracks.
4. Press the [MENU] key twice to close the menu.

## 3.7 Marks, Lines

Marks are useful for denoting important points such as a good fishing spot. Marks can be inscribed in seven shapes and seven colors: Red, yellow, green, light-blue, purple, blue and white.



### 3.7.1 Entering a mark, line

1. Place the cursor where you want a mark to appear.
2. Press the [SHOW/HIDE] key (if necessary) followed by the MARK ENTRY soft key.

The mark is inscribed in the size, color and shape selected on the mark & line menu. The default mark attributes are size, large; color, yellow, and shape, hollow circle (○).

### 3.7.2 Changing mark attributes

You can select the shape, size and color for marks on the MARKS & LINES menu.

1. Press the [MENU] key to show the menu.
2. Press the CHART SETUP, TRACKS & MARKS CONTROL and MARK SETUP soft keys to show the MARKS & LINES menu.

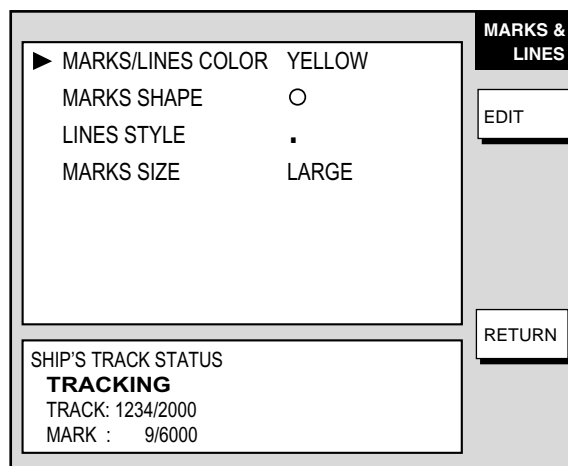

*Marks & lines menu*

3. Select MARKS/LINES COLOR, then press the EDIT soft key.
4. Use the trackball to choose color desired (default setting: yellow).
5. Press the ENTER soft key.
6. Select MARKS SHAPE, then press the EDIT soft key.

### 3. PLOTTER OPERATION

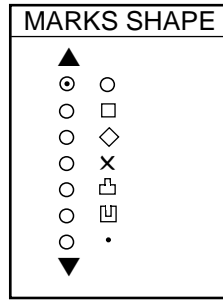

*Marks shape window*

7. Use the trackball to select mark shape desired, then press the ENTER soft key.
8. Select MARKS SIZE, then press the EDIT soft key.
9. Use the trackball to select LARGE (default setting) or SMALL as appropriate.
10. Press the ENTER soft key.
11. Press the [MENU] key twice to close the menu.

#### 3.7.3 Selecting line type

You may inscribe lines to denote good fishing spots, areas of special interest, etc. You can even construct simple charts.

1. Press the [MENU] key followed by the CHART SETUP, TRACKS & MARKS CONTROL and MARK SETUP soft keys to show the MARKS & LINES menu.

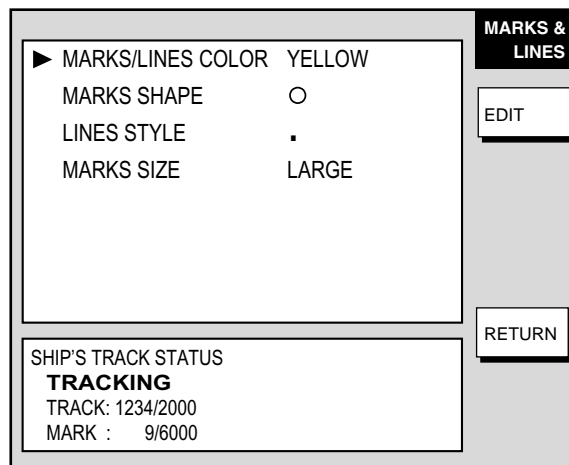

*Marks & lines menu*

2. Select LINES STYLE, then press the EDIT soft key.

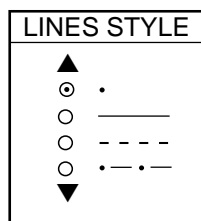

*Lines style window*



- Use the trackball to select line style desired, then press the ENTER soft key. The line style "dot" disables line drawing. Edge of lines is determined by mark shape. For example, selecting the circle shape will join lines with a circle as below.

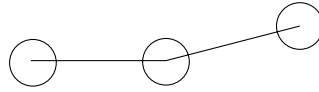

- Press the [MENU] key twice to close the menu.

### 3.7.4 Erasing marks, lines

#### Erasing an individual mark

- Operate the trackball to place the cursor on the mark you want to erase.
- Press the [CLEAR] key to erase the mark.

#### Erasing an individual line

Place the cursor on an end of the line to erase, then press the [CLEAR] key. Placing the cursor at the intersecting point of two line segments will erase both line segments.

#### Erasing marks, lines by area

This feature is not available when the overlay mode is in use.

- Press the [MENU] key followed by the CHART SETUP, TRACKS & MARKS CONTROL and ERASE T & M soft keys to show the ERASE menu.
- Use the trackball to select ERASE MARKS BY AREA, then press the EDIT soft key. The menu is erased and the plotter display appears.
- Use the trackball to place the cursor at the top left-hand corner of the area which you want to erase marks and lines from.
- Press the START soft key or the [ENTER] knob.
- Move the cursor to the bottom right-hand corner of the area which you want to erase marks and lines from.
- Press the END soft key or the [ENTER] knob. You are asked if you are sure to delete the marks/lines selected. Press the [ENTER] knob to delete.
- Press the [MENU] key twice to close the menu.

#### Erasing all marks, lines

You can erase all marks and lines collectively. Be absolutely sure you want to erase all marks and lines - erased marks and lines cannot be restored.

- Press the [MENU] key followed by the CHART SETUP, TRACKS & MARKS CONTROL and ERASE T & M soft keys to show the ERASE menu.
- Use the trackball to select ERASE ALL MARKS/LINES, then press the EDIT soft key.
- Push the [ENTER] knob to erase all marks and lines.
- Press the [MENU] key twice to close the menu.

## 3.8 Waypoints

In navigation terminology, a waypoint is a particular location on a voyage whether it be a starting, intermediate or destination point. A waypoint is the simplest piece of information your equipment requires to get you to a destination, in the shortest distance possible.

This unit has 999 waypoints into which you can enter position information. You may enter a waypoint five ways: at own ship position, at MOB position (see page 1-14 for details), by cursor, by range and bearing, and through the waypoint list (manual input of latitude and longitude).

### 3.8.1 Entering waypoints

#### Entering a waypoint at own ship position

Press the [SAVE/MOB] key momentarily to store your position as a waypoint. This new waypoint is saved to the waypoint list, under the youngest empty waypoint number.

#### Entering a waypoint with the cursor

1. Press the [MENU] key to open the menu.
2. Press the WAYPOINTS/ROUTES, WAYPOINTS and WAYPOINT BY CURSOR soft keys. The plotter display appears.
3. Operate the trackball to place the cursor where you want to enter a waypoint.
4. Press the NEW WPT soft key. The waypoint window appears and it shows waypoint mark shape, waypoint name, comment (default: time and date), position of waypoint and proximity alarm radius.

MARK NAME		NEW WPT
<input type="radio"/>	001 WPT	SELECT MARK
COMMENT		COORD TYPE
02:36 01 JAN 01		N<->S E<->W
LAT	34° 12. 134' N	SAVE
LON	134° 12. 345' W	RETURN
PROXIMITY ALARM RADIUS		
0. 00 nm		

*Waypoint window*

5. **If you do not need to change the waypoint data**, press the SAVE soft key to register the waypoint. The steps which follow show you how to change waypoint data.

6. Press the SELECT MARK soft key.
7. Press the MARK SHAPE soft key to open the mark shape selection window.

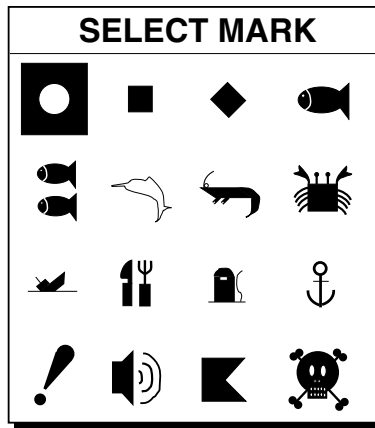

*Waypoint mark shape selection window*

8. Operate the trackball to select shape desired.
9. Press the ENTER soft key.
10. Press the SELECT MARK and MARK COLOR soft keys in that order to open the waypoint mark color selection window. Select the color desired, then press the ENTER soft key.

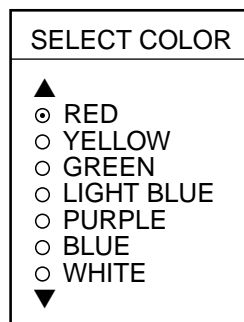

*Waypoint mark color selection window*

**Note:** You cannot change the shape and color of a waypoint when the proximity alarm radius for it is other than “zero.” To change shape or color, enter all zeroes as the proximity alarm radius.

11. You can change the name (6 characters), comment (13 characters), L/L position and the proximity alarm radius for a waypoint as follows:
  - a) Use the trackball to select the NAME, COMMENT, position box or PROXIMITY ALARM RADIUS field. (“Proximity alarm radius” provides for audio and visual alarms when your boat nears a waypoint by the distance specified. The proximity alarm must be turned on in the ALARM menu to use this feature. For details see the paragraph “3.11.6 Proximity alarm.”)
  - b) Use the trackball to select location.
  - c) Enter appropriate alphanumeric character with the alphanumeric keys.
12. Press the SAVE soft key to register the waypoint.
13. Enter another waypoint, or press the [MENU] key to close the menu.

**Entering a waypoint by range and bearing**

This method is useful when you want to enter a waypoint using range and bearing to a target found on a radar.

1. Press the [MENU] key to open the menu.
2. Press the WAYPOINTS/ROUTES, WAYPOINTS and WAYPOINT BY RNG & BRG soft keys.
3. A red "X" appears at own ship position, and it is the origin point for range and bearing. Operate the trackball to place the cursor on the location desired. Range and bearing from own ship to the cursor appear at the top of the display.

**Note:** The origin point of range and bearing can be shifted to the location desired. Operate the trackball to select location, then press the START POINT soft key.

4. Press the NEW WPT soft key. The waypoint window appears and it shows mark shape, waypoint name, comment (default: date and time), position of waypoint and proximity alarm radius.

MARK NAME		NEW WPT
	001 WPT	
COMMENT		
02:36 01 JAN 01		
LAT	34° 12. 134' N	
LON	134° 12. 345' W	
PROXIMITY ALARM RADIUS		SELECT MARK
0. 00 nm		COORD TYPE
		N<-->S E<-->W
		SAVE
		RETURN

*Waypoint window*

5. If necessary, change waypoint data following the instructions from step 6 in "Entering a waypoint with the cursor" on page 3-29.
6. Press the SAVE soft key to register the waypoint.
7. Enter another waypoint as above, or press the [MENU] key to finish.

**Entering a waypoint from the waypoint list**

You can manually enter waypoint position from the waypoint list as follows:

1. Press the [MENU] key to open the menu.
2. Press the WAYPOINTS/ROUTES and WAYPOINTS soft keys.
3. Press the LOCAL LIST (lists waypoints in order from nearest to furthest) or ALPHANUMERIC LIST (lists waypoints in ALPHANUMERIC order) soft key.

<input checked="" type="checkbox"/> ABALONE BRG 350.9° RNG 3.80nm 00:00 01JAN01 35°47.010'N 135°21.000'W		<b>WPT ALPHA</b>  GOTO  NEW WPT  EDIT WPT  ERASE WPT  RETURN
<input checked="" type="checkbox"/> CRAB BRG 050.9° RNG 1.98nm 00:00 01JAN01 34°42.000'N 135°21.050'W		
<input checked="" type="checkbox"/> FISH BRG 065.9° RNG 1.83nm 00:00 01JAN01 34°41.000'N 135°21.030'W		
<input checked="" type="checkbox"/> LOBSTER BRG 144.9° RNG 4.93nm 00:00 01JAN01 38°44.300'N 135°21.010'W		
PUSH ENTER KNOB TO SEARCH FOR 		

<input checked="" type="checkbox"/> FISH BRG 065.9° RNG 1.83nm 00:00 01JAN01 34°41.000'N 135°21.030'W		<b>WPT LOCAL</b>  GOTO  NEW WPT  EDIT WPT  ERASE WPT  RETURN
<input checked="" type="checkbox"/> CRAB BRG 050.9° RNG 1.98nm 00:00 01JAN01 34°42.000'N 135°21.050'W		
<input checked="" type="checkbox"/> ABALONE BRG 350.9° RNG 3.80nm 00:00 01JAN01 35°47.010'N 135°21.000'W		
<input checked="" type="checkbox"/> LOBSTER BRG 144.9° RNG 4.93nm 00:00 01JAN01 38°44.300'N 135°21.010'W		
PUSH ENTER KNOB TO SEARCH FOR 		

Alphanumeric waypoint list

Local waypoint list

*Alphanumeric and local waypoint lists*

4. Press the NEW WPT soft key to show the waypoint window (see the figure on the previous page). Own ship position is shown in the position box.
5. Select the position box and enter position desired.
6. If desired, change waypoint data following the instructions from step 6 in “Entering a waypoint with the cursor” on page 3-29.
7. Press the SAVE soft key to register the waypoint.
8. Press the [MENU] key to close the menu.

### 3.8.2 Editing waypoint data

Waypoint data may be edited from the waypoint list or directly from the plotter display.

**Editing waypoint data from the waypoint list**

1. Press the [MENU] key to open the menu.
2. Press the WAYPOINTS/ROUTES and WAYPOINTS soft keys.
3. Press the LOCAL LIST or ALPHANUMERIC LIST soft key as appropriate.
4. Use the trackball to select the waypoint you want to edit.
5. Press the EDIT WPT soft key.
6. Edit data as appropriate.
7. Press the SAVE soft key.
8. Press the [MENU] key to close the menu.

**Editing a waypoint from the plotter display**

You may edit waypoints from the plotter display as follows:

1. Press the [MENU] key followed by the WAYPOINTS/ROUTES and WAYPOINTS soft key to open the waypoint menu.
2. Press the WAYPOINT BY CURSOR soft key.
3. Operate the trackball to place the cursor on the waypoint which you want to change. A flashing diamond mark appears on the waypoint when it is correctly selected.
4. Press the EDIT/MOVE soft key. Three soft keys replace the EDIT/MOVE soft key:

**EDIT WPT:** Edit from the waypoint entry window.

**MOVE WPT:** Move waypoint to new position with the cursor.

**ERASE WPT:** Erase waypoint. See paragraph 3.8.3.

5. Press the appropriate soft key. For the “EDIT WPT,” the waypoint entry window appears; edit data as appropriate. For “MOVE WPT,” do the following:
  - a) Operate the trackball to place the cursor on the location desired for the waypoint. A line connects previous position and new position.
  - b) Push the [ENTER] knob. The waypoint moves to the cursor position and its position is changed on the waypoint list. If the waypoint is set as destination or is part of a route, you are asked if you are sure to move the waypoint. In this case, push the [ENTER] knob to move the waypoint, or press the [CLEAR] key to cancel.
  - c) Press the [MENU] key to finish.

Range and bearing from own ship to cursor

(1) Select waypoint to move, then press EDIT/MOVE and MOVE WPT soft keys.

(2) Drag cursor to new position, then push the [ENTER] knob.

Press to alternately display range/bearing from own ship to cursor, range/bearing from original waypoint position to cursor position. Below is an example of the range/bearing from original waypoint position to cursor position.

+	34° 22. 3456'N	FROM	5.3°M
	080° 22. 3456'E	FISH	1.45 nm

*Plotter display*

### 3.8.3 Erasing waypoints

#### **Erasing a waypoint directly from the plotter display**

1. Operate the trackball to place the cursor on the waypoint you want to erase. A flashing diamond mark appears over the waypoint when the waypoint is correctly selected.
2. Press the [CLEAR] key. You are asked if you are sure to erase the waypoint.
3. Push the [ENTER] knob. The waypoint is erased from the plotter screen and the waypoint list.

#### **Erasing a waypoint from the menu**

1. Press the [MENU] key followed by the WAYPOINTS/ROUTES and WAYPOINTS soft key to open the waypoint menu.
2. Press the WAYPOINT BY CURSOR soft key.
3. Operate the trackball to place the cursor on the waypoint which you want to erase. A flashing diamond mark appears on the waypoint when it is correctly selected.
4. Press the EDIT/MOVE soft key followed by the ERASE WPT soft key. You are asked if you are sure to erase the waypoint.
5. Push the [ENTER] knob to erase the waypoint.
6. Press the [MENU] key to close the menu. The waypoint is erased from the plotter screen and the waypoint list.

#### **Erasing a waypoint from the waypoint list**

1. Press the [MENU] key to open the menu.
2. Press the WAYPOINTS/ROUTES and WAYPOINTS soft keys.
3. Press the LOCAL LIST or ALPHANUMERIC LIST soft key.
4. Use the trackball to select the waypoint you want to erase.
5. Press the ERASE WPT soft key. You are asked if you are sure to erase the waypoint.
6. Push the [ENTER] knob. The waypoint is erased from both the waypoint list and the plotter screen (if it is currently displayed).
7. Press the [MENU] key to close the menu.

### 3.8.4 Changing waypoint mark size (FURUNO, NavCharts™)

You may change the size of all waypoint marks to small or large (default), or you may turn them off.

1. Press the [MENU] key to open the menu.
2. Press the CHART SETUP and CHART DETAILS soft keys.

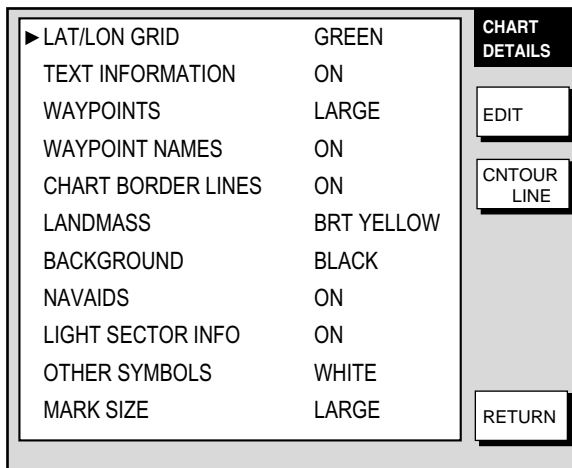

*Chart details menu*

3. Use the trackball to select WAYPOINTS.
4. Press the EDIT soft key.
5. Use the trackball to select LARGE, SMALL or OFF.
  - LARGE:** Shows mark in actual shape.
  - SMALL:** Displays all waypoints with an "X" regardless of mark shape selected.
  - OFF:** Turns off all waypoints and their names. Waypoints currently used in navigation are shown regardless of this setting.
6. Press the ENTER soft key.
7. Press the [MENU] key to close the menu.



### 3.8.5 Searching waypoints

You can search for a waypoint through the alphanumeric waypoint list as follows:

1. Press the [MENU] key.
2. Press the WAYPOINTS/ROUTES, WAYPOINTS and ALPHANUMERIC LIST soft keys to show the alphanumeric list.

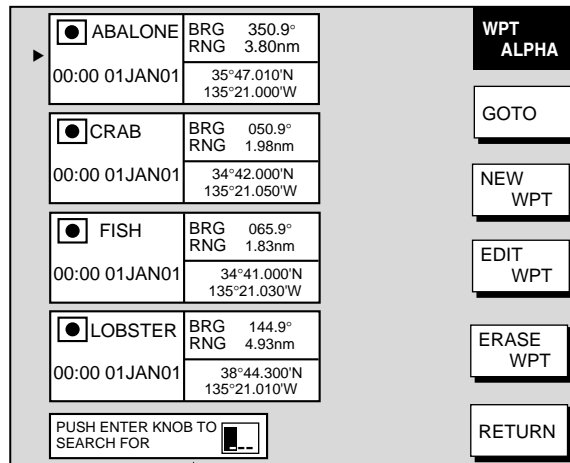

Search window

*Alphanumeric list*

3. Use the trackball and the alphanumeric keys to enter up to three alphanumeric characters in the search window. Then, the waypoint searched appears at the top of the screen.
4. Press the [MENU] key to close the menu.

## 3.9 Routes

Often a trip from one place to another involves several course changes, requiring a series of route points (waypoints) which you navigate to, one after another. The sequence of waypoints leading to the ultimate destination is called a route. Your unit can automatically advance to the next waypoint on a route, so you do not have to change the destination waypoint repeatedly.

You can store up to 200 routes, and a route may have 35 waypoints.

### 3.9.1 Creating routes

#### Entering a route with existing waypoints

This method constructs routes by using existing waypoints.

1. Press the [MENU] key.
2. Press the WAYPOINTS/ROUTES soft key.
3. Press the ROUTES soft key to open the ROUTE menu. (No data will be shown if there are no routes entered.)

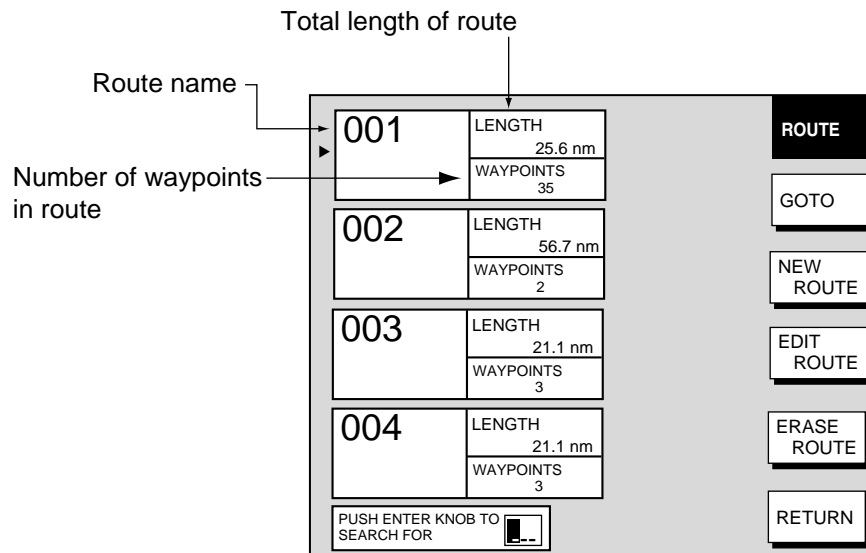

*Route menu*

- Press the NEW ROUTE soft key to open the new route entry screen.

*New route entry screen*

- If desired you can change the route name shown and/or add a comment. A route name may consist of six characters; comment, 13 characters.
- Press the LOCAL LIST or ALPHA LIST soft key to open the waypoint list.
- Use the trackball to select a waypoint, then press the ADD WPT soft key to add it to the route.
- Repeat step 7 to complete the route.
 

**Note:** To clear last-entered waypoint, press the ERASE LST WP soft key. Each press of this key deletes the last waypoint entered.
- Press the SAVE soft key to register the route.
- Press the [MENU] key to close the menu.

### **Entering a route with the cursor**

This method allows you to construct a route directly from the plotter display, using existing waypoints or new positions. Any new position will be saved as a waypoint, under the youngest empty waypoint number.

- Follow steps 1-5 in "Entering a route from the route list" on the previous page.
- Press the PLOT soft key to show the plotter display.
- Operate the trackball to place the cursor on an existing waypoint (ADD WP soft key appears) or new location (ADD NEW WP soft key appears).
- Press the ADD WP soft key (or ADD NEW WP soft key).
- Repeat steps 3 and 4 to complete the route.
- Push the [ENTER] knob to register the route.

**Creating voyage-based routes**

You can create routes based on your ship’s track. The route can be created automatically by time or distance, or manually. This feature is useful when you wish to retrace previous track.

The “SAVE” icon (SAVE) appears at the top of the screen when a voyage-based route is being created.

1. Press the [MENU] key to open the menu.
2. Press the WAYPOINTS/ROUTES soft key.
3. Press the CREATE VOYAGE-BASED ROUTE soft key.

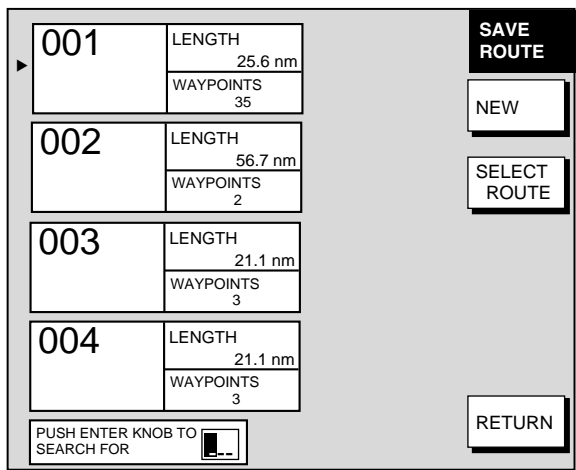

*Save route menu*

4. Press the NEW soft key to show the new route window.

**Note:** If you want to tack voyage-based points onto the end of an existing route, select the route with the trackball, then press the SELECT ROUTE soft key instead of the NEW soft key. Then, go to step 6.

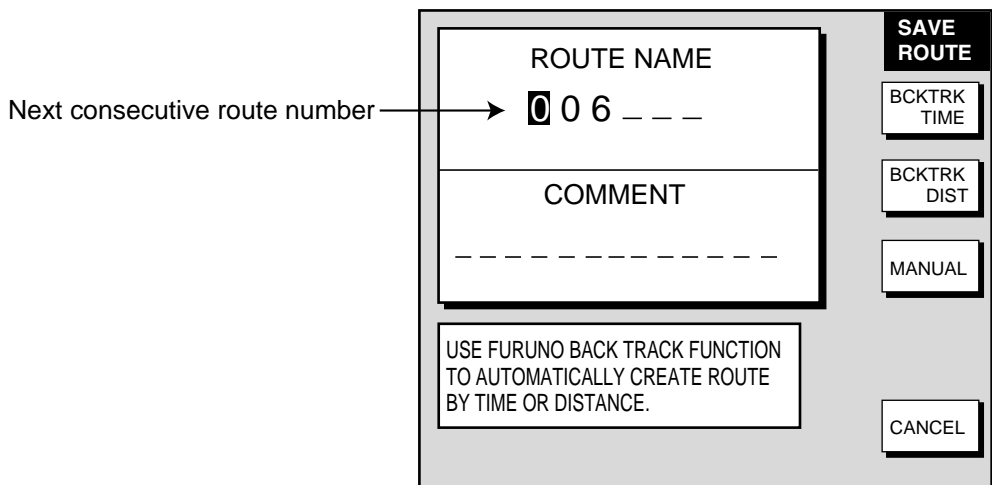

*Save route window*

5. If required, you may change the route name and enter a comment.

6. Choose how to record points for your route, by time, by range or manual entry, by pressing BCKTRK TIME, BCKTRK RANGE or MANUAL soft key as appropriate. For manual entry, go to step 8. For BCKTRK TIME, BCKTRK DIST one of the following displays appears.

TIME INTERVAL
00h01m

(When selecting BCKTRK TIME.)

DISTANCE INTERVAL
00.1nm

(When selecting BCKTRK DIST.)

*Displays for entry of time, distance interval*

7. Enter interval desired with the trackball and the alphanumeric keys. Press the START LOG and RETURN soft keys followed by the [MENU] key to close the menu. At this moment, a voyage-based route will be created.
8. **For manual entry of waypoints, do the following:**
- Press the [SAVE/MOB] key momentarily to enter a waypoint mark at own ship position. A new waypoint is created under the youngest empty waypoint number and added to the route. (At this time you may close the SAVE ROUTE screen by pressing the RETURN soft key followed by the [MENU] key.)
  - Repeat step a) as necessary. 35 waypoints may be entered.

To stop recording waypoints and save the route

You can stop recording waypoints and save the route as shown in the procedure below. When 35 waypoints have been entered the message "Total 35 WPTS have been already registered in the route. Stop creating voyage-based route." is displayed. In this case, automatically creating voyage-based route stops.

- Press the [MENU] key followed by the WAYPOINTS/ROUTES and CREATE VOYAGE-BASED ROUTE soft keys.
- Press the FINISH LOG soft key to stop recording waypoints and save the route.
- Press the [MENU] key to close the menu.

### 3.9.2 Connecting routes

Two routes which you have created can be connected as follows to form a new route.

1. Press the [MENU] key to open the menu.
2. Press the WAYPOINTS/ROUTES soft key.
3. Press the ROUTES soft key.
4. Press the NEW ROUTE soft key.
5. If desired enter route name and comment.
6. Press the CONECT soft key.
7. Use the trackball and the alphanumeric keys to enter the route name for the first route, beneath FIRST in the connect route window.

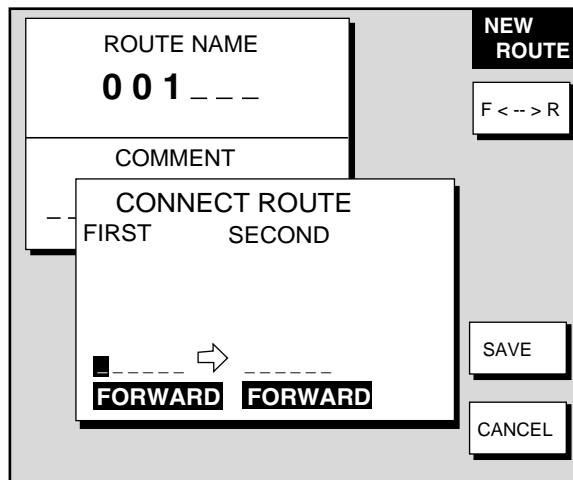

*Connect route window*

8. Press the F<->R soft key to select direction to follow the waypoints of the route, forward or reverse.
9. Enter the route name of the second route as you did for the first route.
10. Press the SAVE soft key.
11. Press the [MENU] key to close the menu.

**Note:** The maximum number of waypoints in a route is 35. If this number is exceeded an error message appears. In this case, delete waypoints in one or both routes so the total number of waypoints does not exceed 35.

### 3.9.3 Inserting waypoints

Waypoints can be inserted in a route as follows:

#### Inserting a waypoint from the route list

1. Press the [MENU] key to open the menu.
2. Press the WAYPOINTS/ROUTES soft key.
3. Press the ROUTES soft key.
4. Use the trackball to select a route.
5. Press the EDIT ROUTE soft key. The route name screen appears.
6. Press the LOCAL LIST soft key.

ROUTE NAME: 001			EDIT ROUTE	
COMMENT:				
01	48°18.290'N	LEG	INSERT WPT	
007WPT	123°14.286'W	90.0°		
02	48°17.341'N	2.86nm	REMOVE WPT	
005WPT	123°10.232'W	322.6°		
03	48°20.261'N	3.08nm	CHANGE WPT	
003WPT	123°11.658'W	75.2°		
04	48°19.862'N	4.99nm	COORD TYPE	
006WPT	123°04.190'W	152.5°		
			RETURN	
			19.87nm	

*Edit route menu*

7. Use the trackball to place the cursor at the location where you want to insert a waypoint.
8. Press the INSERT WPT or CHANGE WPT soft key as appropriate. The local waypoint list appears.

LOCAL LIST	
001	001WPT
	34°44.111'N 135°21.134'W
002	002WPT
	34°43.432'N 135°41.456'W
003	003WPT
	34°14.124'N 135°21.567'W
004	004WPT
	34°34.490'N 135°51.387'W

*Waypoint list for editing a route (local list)*

### 3. PLOTTER OPERATION

9. Use the trackball to select the waypoint you want to insert. (You can switch between the local list and alphanumeric list by using the LOCAL LIST and ALPHA LIST soft keys.)
10. Press the SELECT WPT or CHANGE WPT soft key, whichever is displayed.
11. Press the [MENU] key to close the menu.

#### **Inserting a waypoint from the plotter display**

##### *Inserting a waypoint before first waypoint or after last waypoint in a route*

1. Press the [MENU] key to open the menu.
2. Press the WAYPOINTS/ROUTES soft key.
3. Press the ROUTES soft key.
4. Use the trackball to select a route.
5. Press the EDIT ROUTE soft key.
6. Press the PLOT soft key to show the plotter screen.
7. Operate the trackball to place the cursor on the first (or last) waypoint of the route. A flashing diamond appears over the waypoint when it is correctly selected.
8. Press the ADD TO START soft key or the ADD TO END soft key depending on the waypoint you selected at step 7.
9. Operate the trackball to place the cursor on an existing waypoint (ADD WPT soft key appears) or new location (ADD NEW WP soft key appears).
10. Press the ADD WPT soft key (ADD NEW WP soft key).
11. Press the [MENU] key to close the menu.

##### *Inserting a waypoint in an intermediate location on a route*

1. Follow steps 1 through 6 in "Inserting a waypoint before the first or last waypoint in a route."
2. Operate the trackball to place the cursor on a line connecting waypoints. The SPLIT LEG soft key appears and the line flashes when it is correctly selected.
3. Press the SPLIT LEG soft key.
4. Move the cursor to a new location or select an existing waypoint, in which case the INSERT WPT soft key replaces the INSERT NEW WP soft key.
5. Press the INSERT WPT soft key (INSERT NEW WP soft key).
6. Press the [MENU] key to close the menu.



### 3.9.4 Removing waypoints from a route

#### Removing a waypoint from the route list

1. Press the [MENU] key to open the menu.
2. Press the WAYPOINTS/ROUTES soft key.
3. Press the ROUTES soft key.
4. Select a route.
5. Press the EDIT ROUTE and LOCAL LIST soft keys.
6. Select the waypoint you want to remove.
7. Press the REMOVE WPT soft key.
8. Press the [MENU] key to close the menu.

#### Removing a waypoint from the plotter display

1. Press the [MENU] key to open the menu.
2. Press the WAYPOINTS/ROUTES soft key.
3. Press the ROUTES soft key.
4. Select a route.
5. Press the EDIT ROUTE soft key.
6. Press the PLOT soft key to show the plot screen.
7. Operate the trackball to place the cursor on the waypoint you want to remove from the route.
8. Press the REMOVE WPT soft key. The route is redrawn, eliminating the waypoint removed.
9. Press the [MENU] key to close the menu.

### 3.9.5 Erasing routes

1. Press the [MENU] key to open the menu.
2. Press the WAYPOINTS/ROUTES soft key.
3. Press the ROUTES soft key.
4. Use the trackball to select a route.
5. Press the ERASE ROUTE soft key. You are asked if you are sure to erase the route.
6. Push the [ENTER] knob to erase the route, or the [CLEAR] key to escape.
7. Press the [MENU] key to close the menu.

## 3.10 Navigation

This section shows you how to get to a desired destination by “quick points,” waypoints, port services and routes.

**Note:** Reciprocal setting and canceling of destination is available by outputting the data sentence ZDA from the NavNet unit connected to the navigator.

### 3.10.1 Navigating to a “quick point”

The “quick point” feature allows you to navigate to point(s) without retaining the data indefinitely in your unit’s memory.

#### Selecting quick point entry method

You need to tell your unit how to set the quick point: 1 POINT, 35 POINTS (up to 35 points) or 35PTS/PORT SVC. (For how to navigate to points/port services see “3.10.2 Navigating to ports, port services” on page 3-45.)

1. Press the [MENU] key.
2. Press the PLOTTER SETUP soft key.
3. Use the trackball to select SET GOTO METHOD, then press the EDIT soft key.

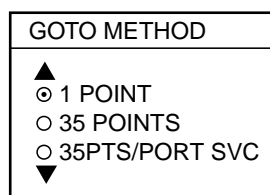

*Go to method window*

4. Use the trackball to select a method.
5. Press the ENTER soft key.
6. Press the [MENU] key to close the menu.

#### Navigating to a single quick point

1. Place the cursor on an existing waypoint (GOTO WPT soft key appears) or a new location (GOTO CURSOR soft key appears).
2. Select “1 POINT” following the procedure in the above paragraph.
3. Depending on the selection you made at step 1, press the GOTO CURSOR or GOTO WPT soft key.

A solid light-blue line with arrows connects between own ship and destination, which is marked as “<QP01>” for cursor-selected location or waypoint name in case of waypoint. This line shows the shortest course to the destination. Arrows on the line show the direction to follow to get to the quick point. Range and bearing from own ship to the destination appear at the top of screen. The quick point location is saved to the waypoint list as waypoint “QP01.”

**Navigating to multiple quick points**

1. Select “35 POINTS” following the procedure in “Selecting quick point entry method” on the previous page.
2. Press the GOTO soft key.
3. Place the cursor on an existing waypoint (SELECT WPT soft key appears) or a new location (ADD QP soft key appears).
4. Depending on the action taken at step 3, press the SELECT WPT or ADD QP soft key. “QP<01>” appears at the cursor location if a quick point is selected. To erase last-entered quick point (waypoint), press the ERASE LST QP (ERASE LST WP) soft key.
5. Repeat steps 3 and 4 to complete the route.
6. Push the [ENTER] knob to finish.

A solid light-blue line with arrows connects between own ship and the first point and all other points are connected with a green dashed line with arrows. Arrows on the line show the direction to follow to get to your destination. Quick points are numbered in sequential order from QP<01> and are saved to the waypoint list. Range and bearing from own ship to the first destination appear at the top of screen. The quick points are saved as a route, under the name “Q>RTE” (Quick Route).

**3.10.2 Navigating to waypoints****Selecting a waypoint from the plotter display**

1. Operate the trackball to select a waypoint.
2. Press the GOTO WPT soft key.

**Note:** GOTO method should be selected to “1 POINT” on the PLOTTER SETUP menu.

**Selecting a waypoint from the waypoint list**

1. Press the [MENU] key to open the menu.
2. Press the WAYPOINTS/ROUTES soft key.
3. Press the WAYPOINTS soft key to open the waypoint menu.
4. Press the LOCAL LIST or ALPHANUMERIC LIST soft key as desired.
5. Use the trackball to select a waypoint.
6. Press the GOTO soft key, and the plotter display appears.

For either of the above methods, a solid light-blue line with arrows runs between waypoint selected and own ship’s position. Arrows on the line show the direction to follow to get to the waypoint. Waypoint data appears at the top of screen.

**Selecting an external waypoint**

You can select a waypoint (or route) entered at an external plotter connected with NMEA cable. This function requires RMB sentence.

1. Press the [MENU] key, PLOTTER SETUP soft key to show the PLOTTER SETUP menu.
2. Use the trackball to select QP.
3. Press the ENTER soft key or [ENTER] knob to show the QP window.

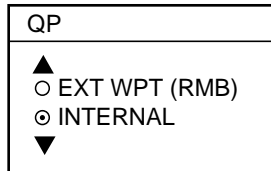

*QP window*

4. Select EXT WPT (RMB).
5. On a connected external plotter, set a waypoint (or route) as the destination. Selected waypoint (route) appears on the NavNet plotter screen. (on radar screen, a lollipop appears to show the waypoint.)

**3.10.3 Navigating to ports, port services (NavCharts™/C-MAP)**

NavCharts™/C-MAP have a port service list which shows services available at ports or harbors. (See page 3-13.) You can use the list to set your destination as follows:

1. Select “35 PTS/PORT SVC” following the procedure in “Selecting quick point entry method” on page 3-44.
2. Place the cursor on the location desired, then press the GOTO soft key. Soft key titles change as in the figure below.

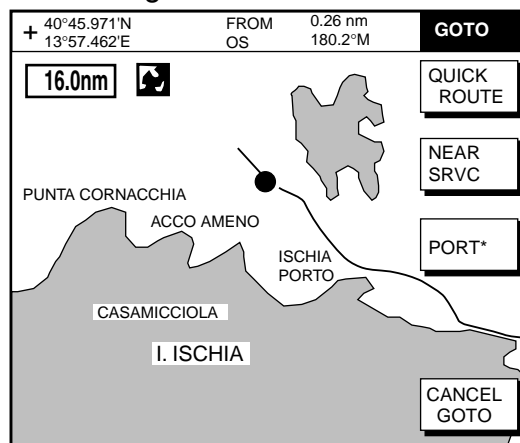

*\*NavCharts™ only*

*Plotter display*

3. Press the PORT (NavCharts™ only) or NEAR SRVC soft key depending on objective. PORT shows a list of ports in your area. NEAR SRVC displays the port service list.

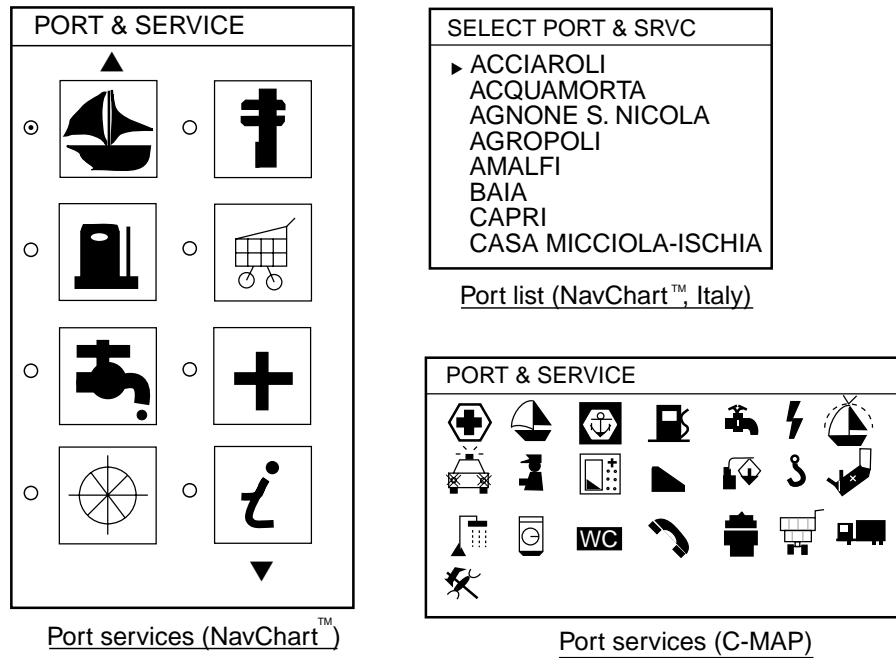

Port services and sample port list

4. **If you selected PORT (NavCharts™ only) at step 3**, use the trackball to select a port, then press the ENTER soft key. Make a route using the soft keys, then push the [ENTER] knob. (If you want to go directly to that port, simply press the ADD QP soft key followed by the [ENTER] knob.)

**If you selected NEAR SRVC at step 3**, select service mark desired with the trackball and then push the ENTER soft key or the [ENTER] knob. Then, the display shows the locations of those services nearest you. (The figure below shows the location of filling stations in an area in southern Italy.) Use the trackball to place the “hand cursor” on the port service icon desired, then press the ENTER soft key. Make a route using the soft keys, then push the [ENTER] knob. (If you want to go directly to location selected, simply press the ADD QP soft key followed by pushing the [ENTER] knob.)

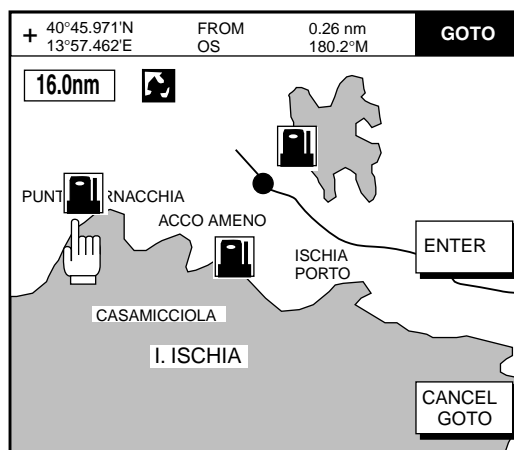

Sample filling station locations (southern Italy)

### 3.10.4 Following a route

#### Selecting the route to follow

1. Press the [MENU] key to open the menu.
2. Press the WAYPOINTS/ROUTES soft key.
3. Press the ROUTES soft key to open the route list.
4. Select a route.
5. Press the GOTO soft key to show the plotter display. The cursor is on the waypoint nearest own ship.

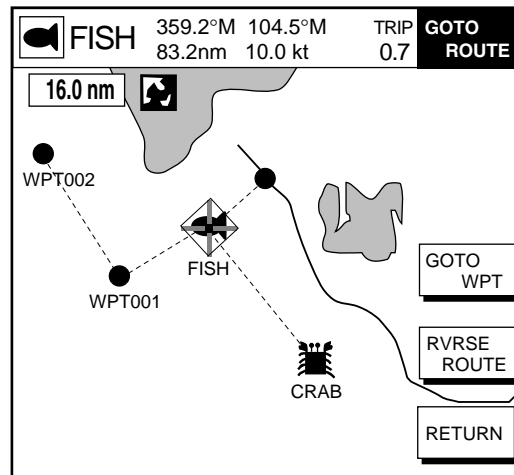

*Plotter display, route selected as destination*

6. Operate the trackball to place the cursor on the waypoint or leg in the route from where to start navigating the route.
7. Press the GOTO WPT or FOLLOW LEG soft key, depending on the action taken at step 6.

A solid light-blue line runs between own ship and first waypoint. Green dashed lines connect all other waypoints. The arrows on the lines show the direction to traverse the route.

#### Navigating waypoints in reverse order

Press the RVRSE ROUTE soft key followed by the [ENTER] knob to navigate waypoints in reverse order. The arrows on the route line point in the direction selected.

### Restarting navigation

When you steer to avoid an obstacle or the vessel drifts, you may go off your intended course, as in Line 1 in the figure below. Also, if you don't need to return to the original course, you can go directly to the next waypoint, as in Line 2 in the figure below. In these cases, use the restart navigation function to restart navigation.

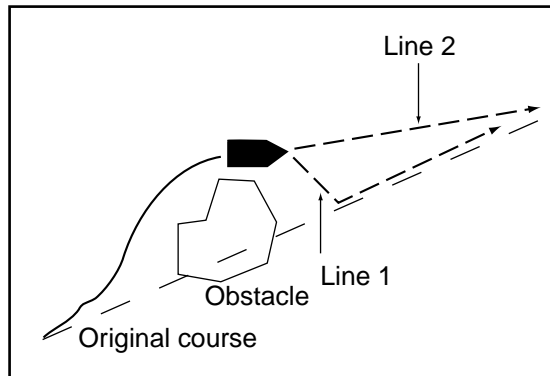

*Example of when to restart navigation*

1. Press the [MENU] key to open the menu.
2. Press the WAYPOINTS/ROUTES soft key.
3. Press the LOG soft key.

TO Waypoint (WPT name in reverse video)

Passed waypoint (gray characters)

Estimated Time of Arrival at destination

ETA 23:59 30. APR		LOG		
01	48°18.290'N	LEG	RE-START	
007WPT	123°14.286'W	90.0°		
02	48°17.341'N	2.86nm		STOP
005WPT	123°10.232'W	322.6°		RVRSE
03	48°20.261'N	3.08nm	SPEED	
003WPT	123°11.658'W	75.2°		
04	48°19.862'N	4.99nm		
006WPT	123°04.190'W	152.5°	COORD TYPE	
		19.87nm		

Replaces triangle when selecting a route leg.

Replaced by "FOLLOW LEG" when selecting a route leg.

*Log display*

4. Use the trackball to select a waypoint or a route leg. When a route leg is selected the single arrow cursor is replaced by double arrows.
5. Press the RESTART soft key or FOLLOW LEG soft key in case of route leg.

**Note:** Navigation may be restarted from the plotter display, with the RESTART key, when a single quick point (QP<01>) is selected for navigation.

6. Press the [MENU] key to close the menu.

**Setting speed for ETA calculation**

Speed, which may be input manually or automatically, is required to calculate ETA (Estimated Time of Arrival) to a destination.

1. Press the [MENU] key to open the menu.
2. Press the WAYPOINTS/ROUTES soft key.
3. Press the LOG soft key.
4. Press the SPEED soft key.

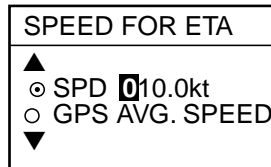

*Select speed for ETA window*

5. Enter speed manually in the SPD field, or use GPS speed data (if applicable) by selecting GPS AVG. SPEED.
6. Press the ENTER soft key or the [ENTER] knob to register your selection.
7. Press the [MENU] key to close the menu.

**Switching waypoints**

When you arrive to a waypoint on a route, you can switch to the next waypoint by one of the three methods below.

**PERPENDICULAR:** Automatically switches the destination waypoint when the boat comes passes an imaginary perpendicular line passing through the center of the destination waypoint.

**ARRVL ALM CRCL:** Destination waypoint is automatically switched when the boat comes within the arrival alarm range. For how to set the arrival alarm, see the paragraph 3.11.2 Arrival alarm.

**MANUAL:** The destination waypoint may be manually switched by using the RESTART soft key (see page 3-49). This function is operative when “1 POINT” is selected as the GOTO method (see page 3-44).

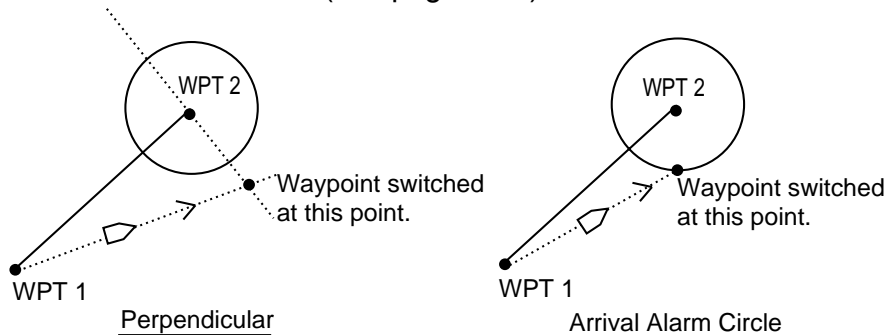

*Automatic waypoint switching methods*



To select waypoint switching method do the following:

1. Press the [MENU] key.
2. Press the PLOTTER SETUP soft key.
3. Use the trackball to select WAYPOINT SWITCHING.
4. Press the EDIT soft key to show the waypoint switching window.
5. Use the trackball to select appropriate waypoint switching method; PERPENDICULAR, ARRVL ALM CRCL (default setting), or MANUAL.
6. Press the ENTER soft key.
7. Press the [MENU] key to close the menu.

### **3.10.5 Canceling route navigation**

1. Press the [MENU] key to open the menu.
2. Press the WAYPOINTS/ROUTES soft key.
3. Press the LOG soft key.
4. Press the STOP soft key.
5. Push the [ENTER] knob.
6. Press the RELEASE soft key.
7. Push the [ENTER] knob.

### 3.11 Alarms

The plotter section has eight conditions which generate both audio and visual alarms: arrival alarm, anchor watch alarm, XTE (Cross Track Error) alarm, proximity alarm, speed alarm, trip alarm, water temperature alarm and bottom alarm. (The bottom and water temperature alarms, which require depth and water temperature data, may also be set on the sounder alarm menu. For these alarms see Chapter 4.)

You may set up the plotter alarms on the ALARM menu, which may be displayed by pressing the [ALARM] key.

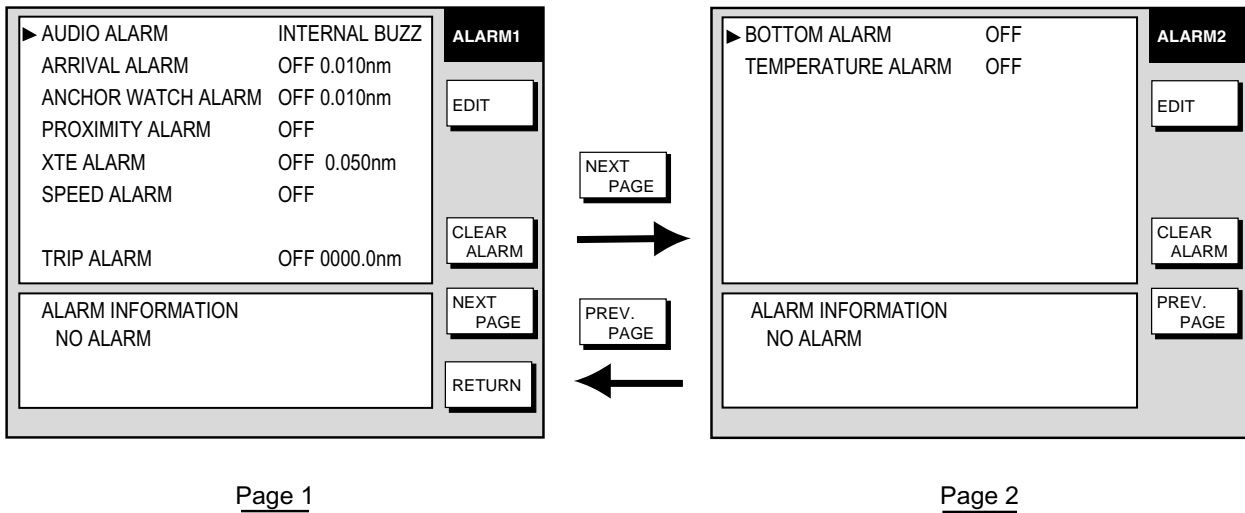

*Plotter alarm menu*

#### 3.11.1 Audio alarm on/off

Audio and visual alarms are released whenever an alarm setting is violated. You can enable or disable the audio alarm as follows:

1. Press the [ALARM] key to show the alarm menu.
2. Use the trackball to select AUDIO ALARM.
3. Press the EDIT soft key to show the audio alarm window.

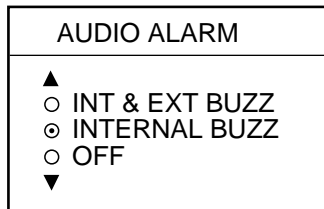

*Audio alarm window*

4. Use the trackball to select INT & EXT BUZZ (Internal + External alarm), INTERNAL BUZZ (Internal alarm) or OFF as appropriate. This turns on or off the audio alarm globally for all alarms, including radar.
5. Press the ENTER soft key.
6. Press the [ALARM] key to finish.

### 3.11.2 Arrival alarm

The arrival alarm informs you that your boat is approaching a destination waypoint. The area that defines an arrival zone is that of a circle which you approach from the outside of the circle. The alarm will be released if your boat enters the circle. When the arrival alarm is active a red dashed circle marks the arrival alarm area. Note that the arrival alarm and anchor watch alarm can be turned on together.

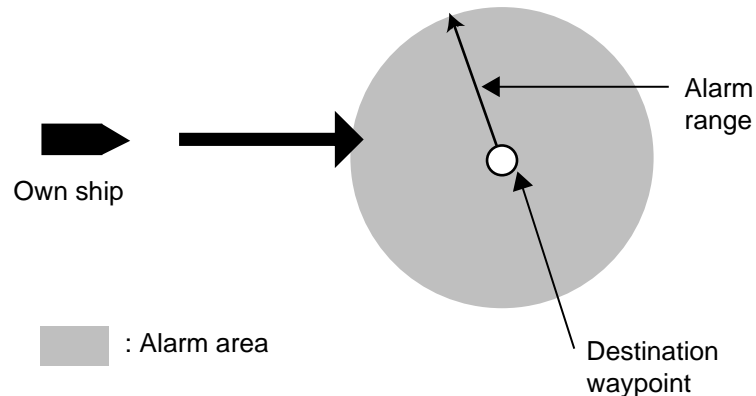

#### *How the arrival alarm works*

1. Press the [ALARM] key to open the alarm menu.
2. Use the trackball to select ARRIVAL ALARM.
3. Press the EDIT soft key to show the arrival alarm window.

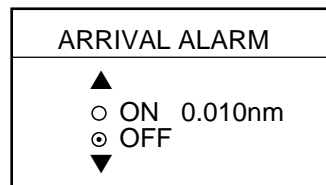

#### *Arrival alarm window*

4. Use the trackball to select ON.
5. Use the trackball and the alphanumeric keys to enter alarm setting: Operate the trackball to select digit; use the alphanumeric keys to enter value. The available arrival alarm setting is 0.001 to 9.999 miles.
6. Press the ENTER soft key or push the [ENTER] knob to register setting.
7. Press the [ALARM] key to finish.

### 3.11.3 Anchor watch alarm

The anchor watch alarm informs you that your boat is moving when it should be at rest. When the anchor watch is active, a red dashed circle with an “X” at its center marks the anchor watch area.

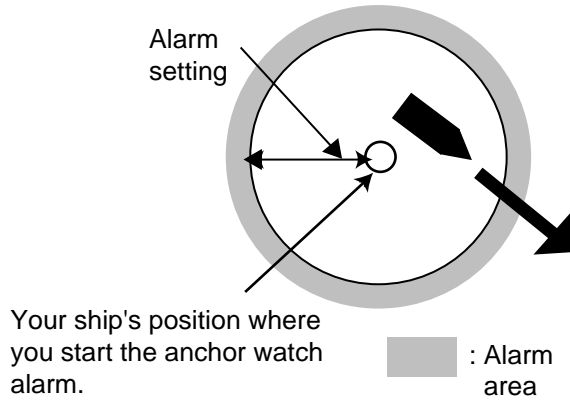

#### *How the anchor watch alarm works*

1. Press the [ALARM] key to open the alarm menu.
2. Use the trackball to select ANCHOR WATCH ALARM.
3. Press the EDIT soft key to open the anchor alarm window.

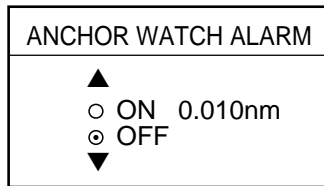

*Anchor watch alarm window*

4. Use the trackball to select ON.
5. Use the trackball and the alphanumeric keys to enter alarm setting: Operate the trackball to select digit; use the alphanumeric keys to enter value. The available anchor watch setting is 0.001 to 9.999 miles.
6. Press the ENTER soft key or push the [ENTER] knob to register setting.
7. Press the [ALARM] key to finish.

**Note:** If the arrival alarm range is changed, turn off the anchor watch alarm and then turn it on again to give priority to the anchor watch alarm.

### 3.11.4 XTE (Cross-Track Error) alarm

The XTE alarm warns you when your boat is off its intended course. When the XTE alarm is active two red dashed lines mark the XTE alarm area.

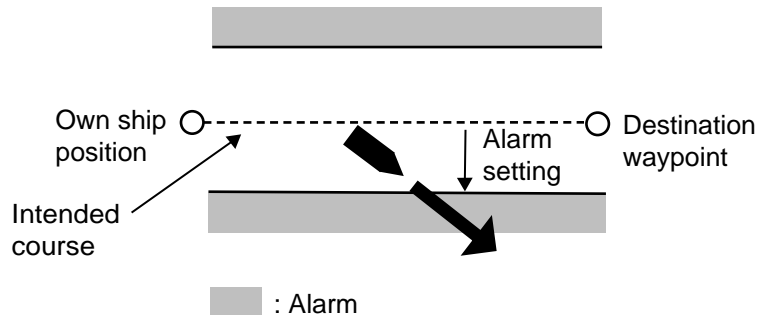

*How the XTE alarm works*

1. Press the [ALARM] key to open the alarm menu.
2. Use the trackball to select XTE ALARM.
3. Press the EDIT soft key to open the XTE alarm window.

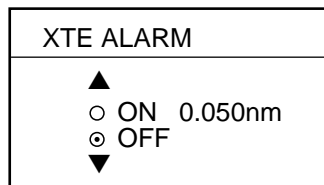

*XTE alarm window*

4. Use the trackball and the alphanumeric keys to enter alarm setting: Operate the trackball to select digit; use the alphanumeric keys to enter value. The available XTE alarm setting is 0.001 to 9.999 miles.
5. Press the ENTER soft key or push the [ENTER] knob to register setting.
6. Press the [ALARM] key to finish.

### 3.11.5 Speed alarm

The speed alarm warns when your boat's speed is within or under/over the speed range set.

1. Press the [ALARM] key to open the alarm menu.
2. Use the trackball to select SPEED ALARM.
3. Press the EDIT soft key to display the speed alarm window.

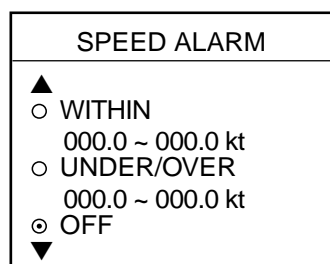

*Speed alarm window*

### 3. PLOTTER OPERATION

4. Use the trackball to select WITHIN, UNDER/OVER, or OFF as appropriate
5. For WITHIN and UNDER/OVER use the trackball and the alphanumeric keys to enter alarm range: Operate the trackball to select digit; use the alphanumeric keys to enter value.
6. Press the ENTER soft key or push the [ENTER] knob to register setting.
7. Press the [ALARM] key to finish.

#### 3.11.6 Proximity alarm

The proximity alarm alerts you when own ship nears a waypoint, which is marked with the proximity mark, by the proximity alarm radius set for that waypoint on the waypoint list. When own ship is within a waypoint's proximity alarm radius, the alarm sounds. The proximity mark remains on the screen until the waypoint is erased.

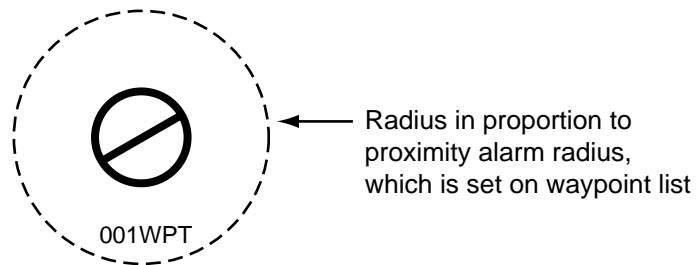

*Proximity mark*

1. Press the [ALARM] key to open the alarm menu.
2. Use the trackball to select PROXIMITY ALARM.
3. Press the EDIT soft key to show the proximity alarm window.

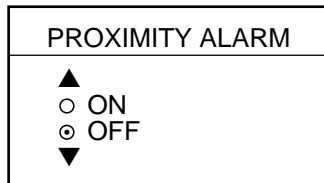

*Proximity alarm window*

4. Use the trackball to select ON or OFF as appropriate, then press the ENTER soft key.
5. Press the [ALARM] key to finish.

### 3.11.7 Trip alarm

The trip alarm informs you when you have traveled a certain distance.

1. Press the [ALARM] key to open the alarm menu.
2. Use the trackball to select TRIP ALARM.
3. Press the EDIT soft key to show the trip alarm window.

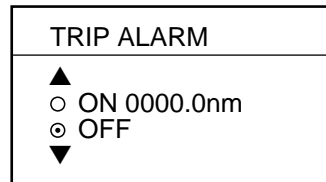

*Trip alarm window*

4. Select ON.
5. Use the trackball and the alphanumeric keys to enter alarm setting: Operate the trackball to select digit; use the alphanumeric keys to enter value.
6. Press the ENTER soft key or push the [ENTER] knob to register setting.
7. Press the [ALARM] key to finish.

### 3.11.8 Alarm information

When an alarm setting has been violated, the buzzer sounds and the speaker icon appears and is red. Press the [CLEAR] key to silence the alarm. You can see which alarm has been violated on the ALARM menu. In the example below the arrival alarm has been violated.

1. Press the [ALARM] key. The name of the offending alarm appears in the alarm information window.

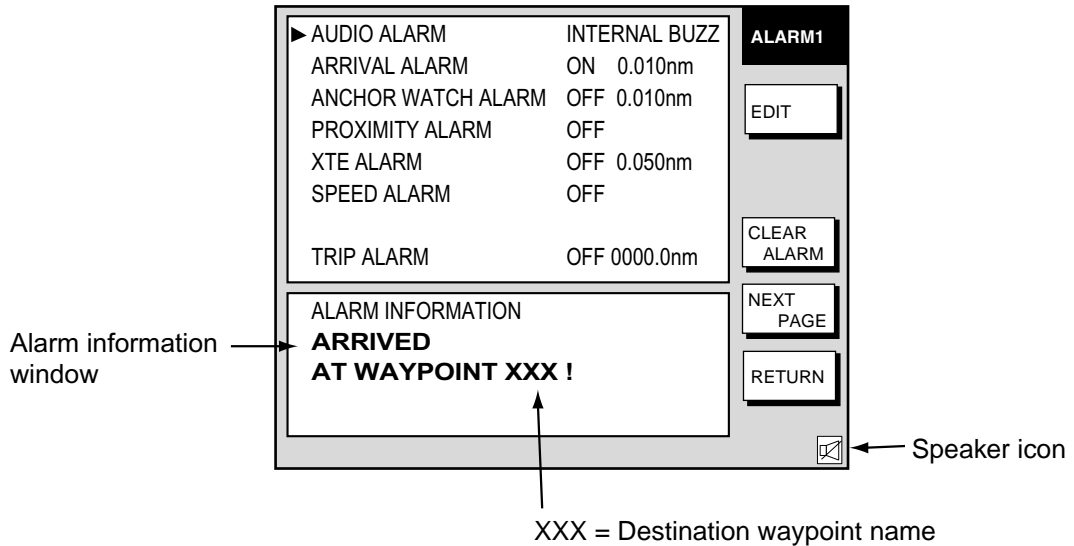

*Plotter alarm menu, page 1*

2. Press the CLEAR ALARM soft key to acknowledge the alarm (and silence the buzzer if it was not done with the [CLEAR] key). The color of the speaker icon changes from red to background color. The icon remains on the screen until the cause of the alarm is eliminated or the alarm is disabled. If more than one alarm has been violated the message CONTINUE appears at the bottom of the alarm information window. In this case, press the NEXT INFO soft key to see which other alarms have been violated.
3. Press the [ALARM] key to finish.

**Note:** The alarm icon is red when an alarm setting is violated, and changes to background color when the [CLEAR] key or CLEAR ALARM soft key is pressed. The color does not change regardless of how many other alarms are violated.



**Alarm messages**

The table below shows the plotter alarm messages and their meanings.

*Plotter alarm messages and their meanings*

<b>Message</b>	<b>Meaning</b>
ARRIVED AT WAYPOINT XXX! (XXX = waypoint name)	Arrival alarm violated.
ENTERED INTO AVOIDANCE AREA!	Proximity alarm violated.
EXCEEDED ANCHOR WATCH LIMIT!	Anchor watch alarm violated.
EXCEEDED XTE LIMIT!	XTE alarm violated.
SPEED ALARM!	Speed alarm violated.
TEMPERATURE ALARM!	Water temperature alarm violated.
TRIP ALARM! MILEAGE EXCEEDED	Trip alarm violated.

## 3.12 Resetting Trip Distance

Trip distance is shown on the navigation data display. You can reset the trip distance to zero as follows:

1. Press the [MENU] key.
2. Press the SYSTEM CONFIGURATION and GENERAL SETUP soft keys in that order to show the GENERAL SETUP menu.

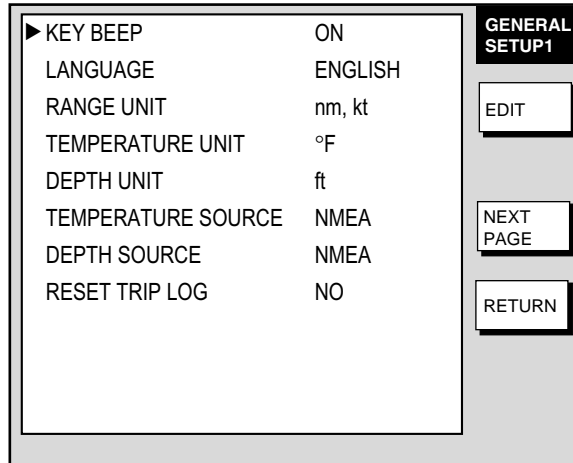

*General setup menu, page 1*

3. Use the trackball to select RESET TRIP LOG, then press the EDIT soft key.
4. Use the trackball to select YES, then press the ENTER soft key.
5. Press the [MENU] key to close the menu.

# 4. VIDEO SOUNDER OPERATION

---

With connection of the optional Network Sounder ETR-6/10N/30N you can show video sounder images on the display.

## 4.1 Principle of Operation

The video sounder determines the distance between its transducer and underwater objects such as fish, lake bottom or seabed and displays the results on screen. It does this by utilizing the fact that an ultrasonic wave transmitted through water travels at a nearly constant speed of 4800 feet (1500 meters) per second. When a sound wave strikes an underwater object such as fish or sea bottom, part of the sound wave is reflected back toward the source (transducer). Thus by calculating the time difference between the transmission of a sound wave and the reception of the reflected sound wave, the depth to the object can be determined.

The entire process begins in the network sounder. Transmitter power is sent to the transducer as a short pulse of electrical energy. The electrical signal produced by the transmitter is converted into an ultrasonic signal by the transducer and transmitted into the water. Any returning signals from intervening objects (such as a fish school) are received by the transducer and converted into an electrical signal. The signals are then amplified in the amplifier section, and finally, displayed on screen.

The picture displayed is made up of a series of vertical scan lines, one for each transmission. Each line represents a snapshot of what has occurred beneath the boat. A series of snapshots are accumulated side by side across the screen, and the resulting contours of the bottom and fish between the bottom and surface are displayed.

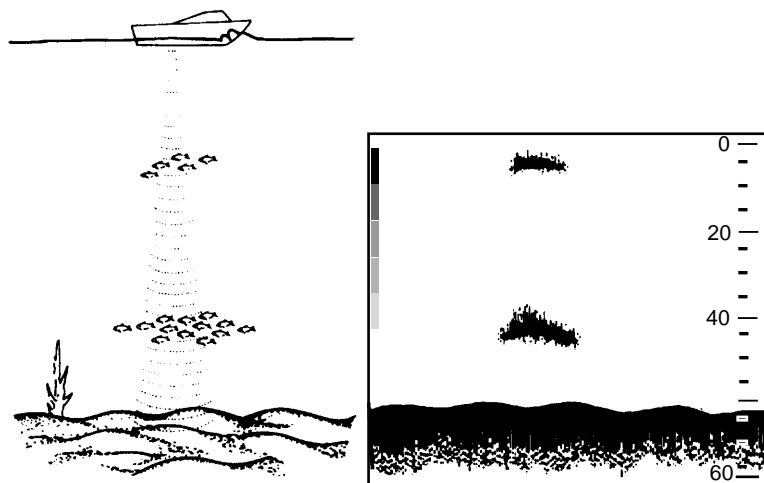

*Underwater conditions and video sounder display*

## 4.2 Sounder Displays

### 4.2.1 Selecting a sounder display

There are seven display modes from which to choose: dual frequency, single frequency, marker zoom, bottom zoom, bottom lock, bottom discrimination, and A-scope.

To select a display;

1. Press the [DISP] key and then select sounder display desired.
2. If not already displayed, press the [HIDE/SHOW] soft key to show the sounder soft keys.
3. Press the DISPLY MODE soft key to show the display mode window.

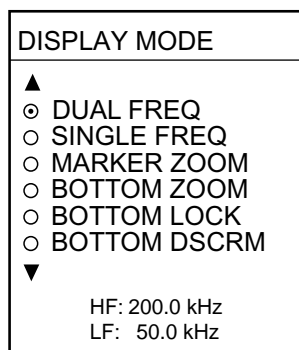

*Display mode window*

4. Use the trackball or the [ENTER] knob to select a display.
5. Press the RETURN soft key to close the window.

**Note:** On menus which show the RETURN soft key you may use it or the ENTER knob to register setting and close the window.

### 4.2.2 Description of sounder displays

#### Single-frequency display

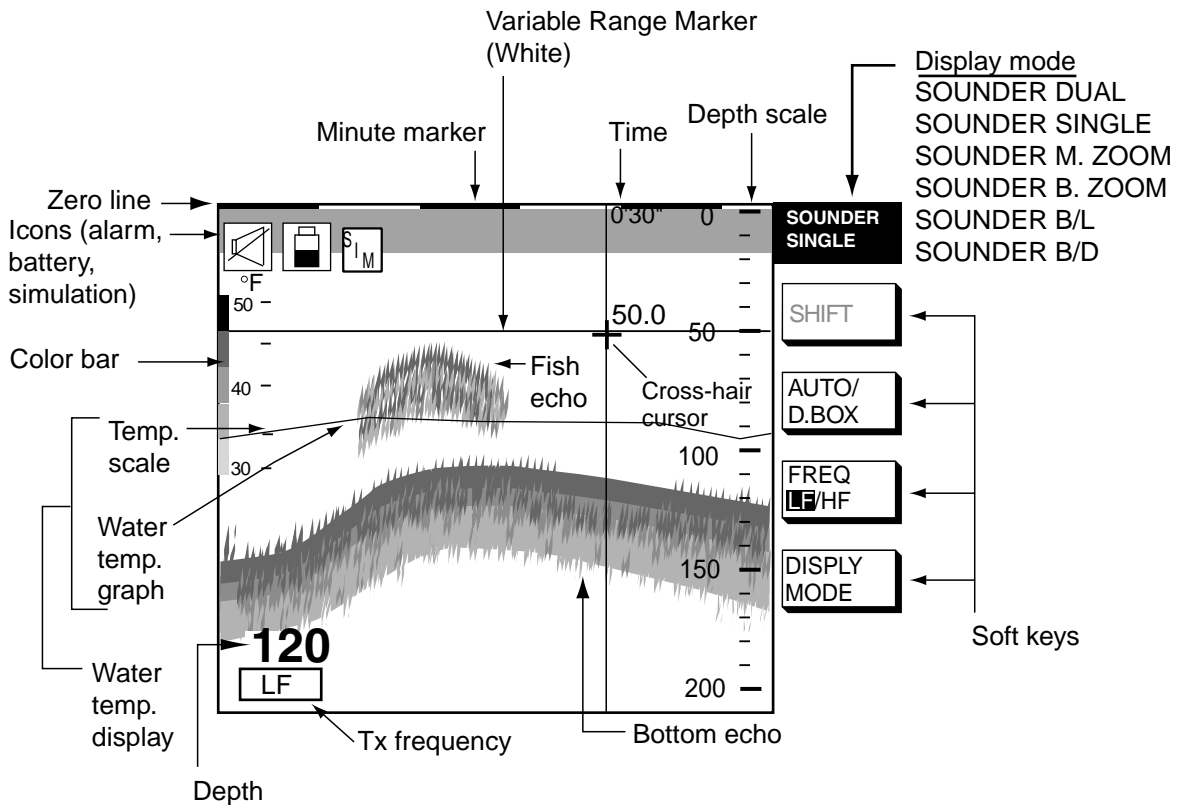

*Indications on the single frequency display*

**Note:** The water temperature display requires an appropriate water temperature sensor. It can be turned on or off with TEMPERATURE GRAPH on the SOUNDER MENU.

#### Selecting transmission frequency

The single frequency display shows either the LF (low frequency) picture or HF (high frequency) picture. To select transmission frequency, press the FREQ LF/HF soft key. "LF" or "HF" is highlighted on its key label with each press of the key.

## 4. VIDEO SOUNDER OPERATION

### **Dual-frequency display**

The dual-frequency display provides both LF and HF pictures. This display is useful for comparing the same picture with two different sounding frequencies.

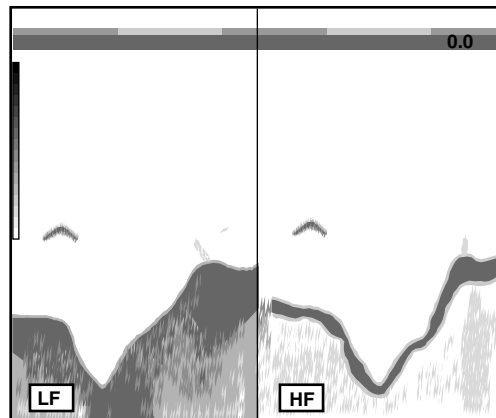

*Dual-frequency display*

### **LF picture**

The sounder uses ultrasonic pulses to detect bottom conditions. The lower the frequency of the pulse, the wider the detection area. Therefore, the low frequency is useful for general detection and judging bottom condition.

### **HF picture**

The higher the frequency of the ultrasonic pulse the better the resolution. Therefore, the high frequency is ideal for detailed observation of fish school.

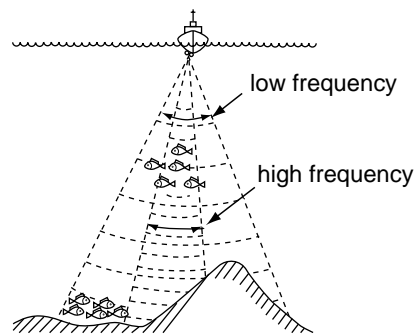

*Sounding area and transmission frequency*

### **Marker-zoom display**

The marker-zoom display expands a selected area of the normal sounder picture to full vertical size of the screen on the left-half window. You may specify the portion to expand by operating the VRM (Variable Range Marker), which you can shift with the [ENTER] knob. The area between the VRM and zoom marker is expanded. The length of the segment is equal to one division of the depth scale.

**Note:** The VRM is set independently from other displays in case of multiple displays.

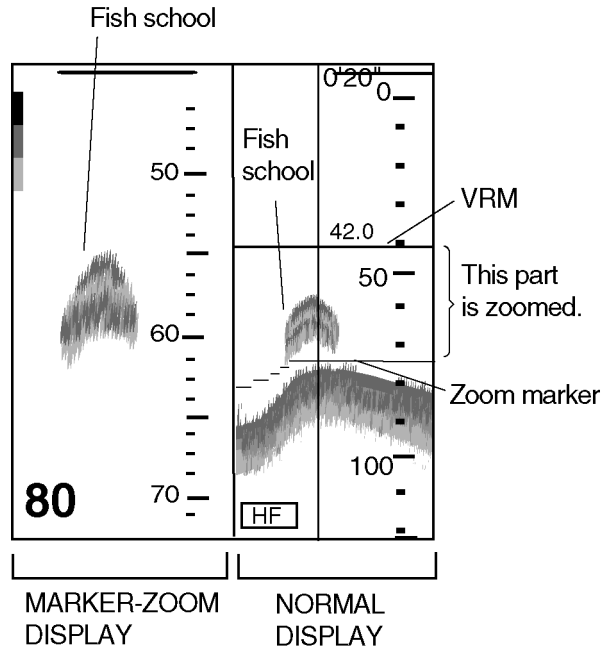

*Marker-zoom display plus normal sounder display*

**Bottom-zoom display**

The bottom-zoom display expands bottom and bottom fish echoes by the zoom range selected on the SOUNDER RANGE SETUP menu (see paragraph 5.9.3), and is useful for determining bottom hardness. A bottom displayed with a short echo tail usually means it is a soft, sandy bottom. A long echo tail means a hard bottom.

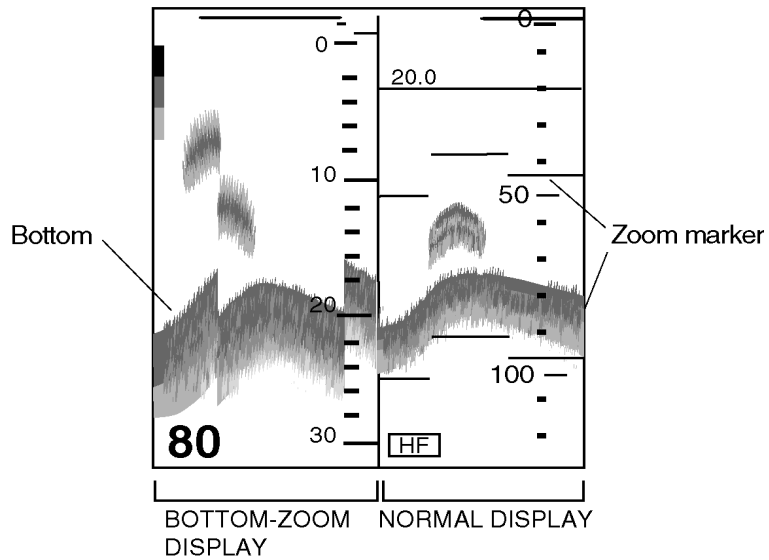

*Bottom-zoom display plus normal sounder display*

#### 4. VIDEO SOUNDER OPERATION

##### **Bottom-lock display**

The bottom-lock display provides a compressed normal picture on the right half of the screen and a 10 or 20 feet (3 or 6 meter) wide layer in contact with the bottom is expanded onto the left half of the screen. This mode is useful for discriminating bottom fish from the bottom echo. You may select the bottom lock range from the SOUNDER RANGE SETUP menu. For details, see paragraph 5.9.3.

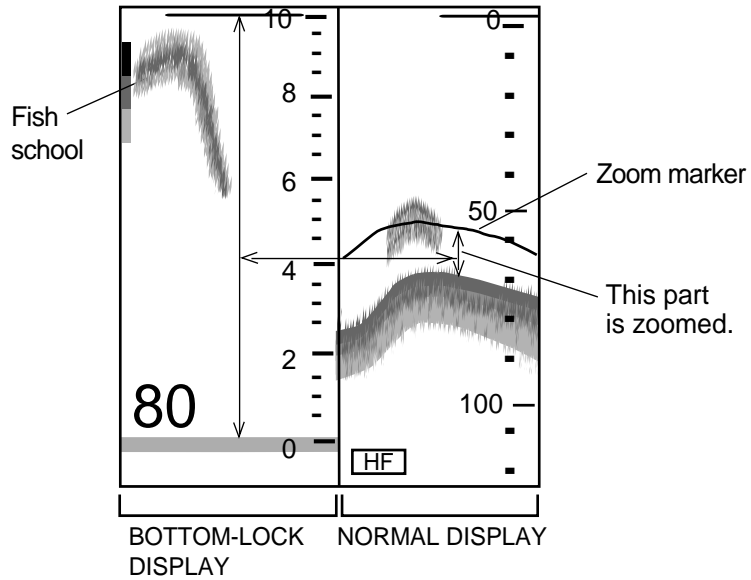

*Bottom-lock display plus normal sounder display*



**Bottom discrimination display**

The bottom discrimination mode displays the bottom echo to help you determine bottom hardness. A bottom displayed with a short echo tail usually means it is a soft, sandy bottom. A long echo tail means a hard bottom.

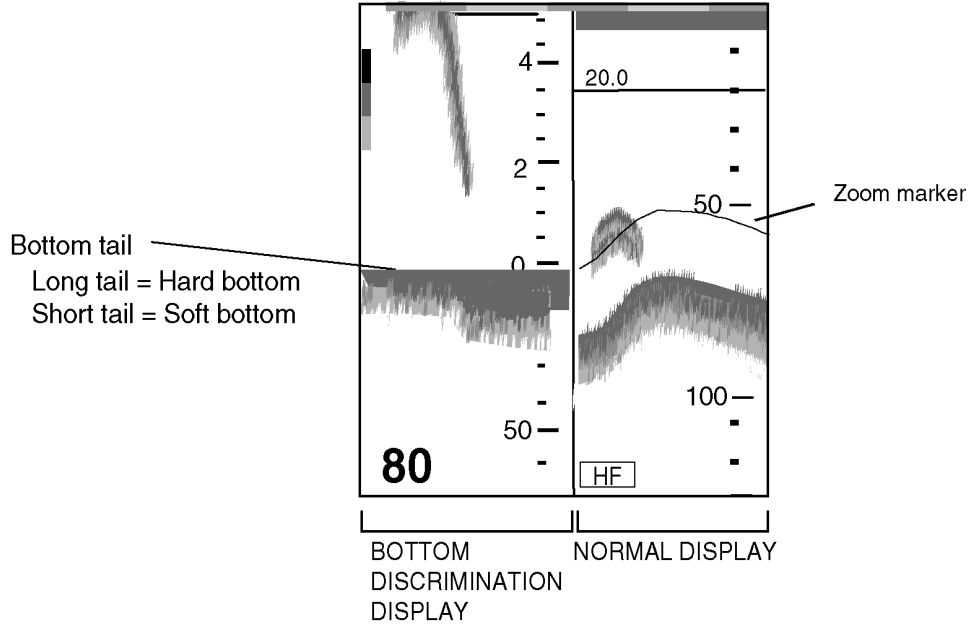

*Bottom discrimination display*

**A-scope display (display only)**

The A-scope display, available in all modes, shows echoes at each transmission with amplitudes and tone proportional to their intensities, on the right 1/10 of the screen. It is useful for estimating fish species and bottom composition. To turn on the A-scope display, press the DISPLAY MODE soft key, select display mode desired, then press the A-SCOPE soft key to show "ON" on its label. For modes other than SINGLE FREQ the screen must be split horizontally to show the A-scope display.

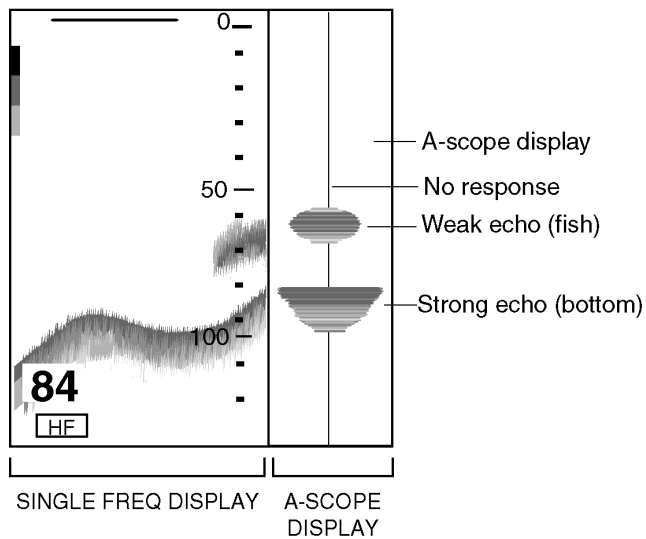

*A-scope display*

### 4.2.3 Selecting screen split method in combination displays

On combination sounder displays you can split the screen vertically or horizontally, using the SPLIT soft key as below.

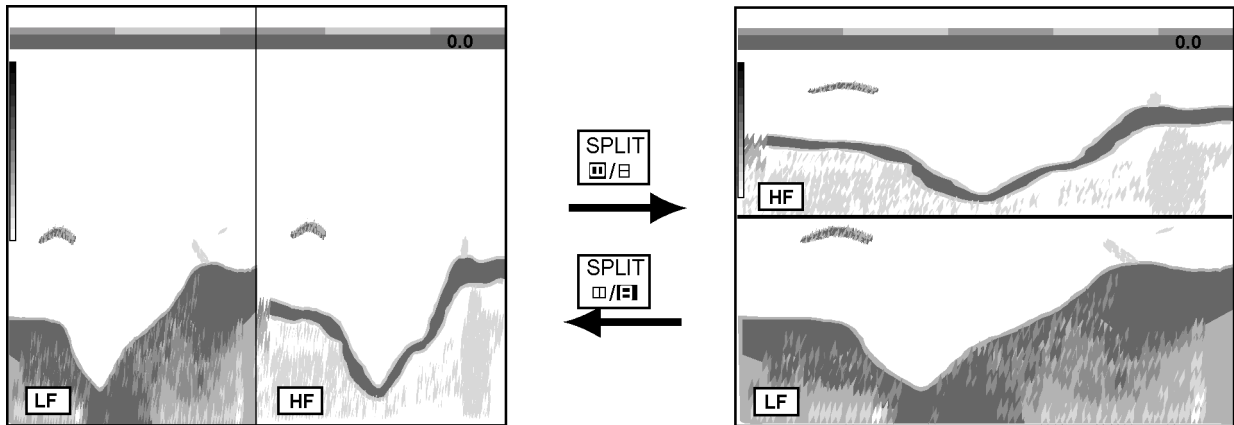

*How to use the SPLIT soft key (example: dual frequency display)*

## 4.3 Automatic Sounder Operation

Automatic sounder operation is useful when you are preoccupied with other tasks and do not have the time to adjust the display.

### 4.3.1 How the automatic sounder works

The automatic sounder function automatically selects the proper gain, range scale and clutter suppression level according to the depth. It works as follows:

- The range changes automatically to locate the bottom on the lower half of the screen. The range jumps to one step shallower range when the bottom echoes reach a half way point of the full scale from the top and to one step deeper range when they come to the lower edge of the scale.
- The gain is automatically adjusted to display the bottom echo in reddish brown (default color arrangement).
- Clutter, which suppresses low level noise, is automatically adjusted.

### 4.3.2 Types of automatic sounder modes

Two types of automatic sounder modes are available: CRUISING and FISHING. CRUISING is for tracking the bottom, and FISHING is for searching fish schools. CRUISING uses a higher clutter rejection setting than FISHING therefore it is not recommended for fish detection - weak fish echoes may be erased by the clutter suppression circuit.

### 4.3.3 How to enable automatic sounder operation

1. If not displayed, press the [HIDE/SHOW] key to show the sounder soft keys.
2. Press the AUTO/D. BOX soft key.

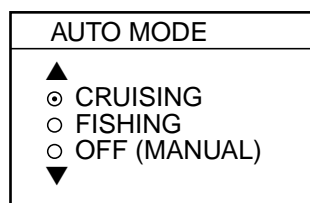

*Mode/frequency window*

3. Use the trackball or the [ENTER] knob to select CRUISING or FISHING as appropriate.
4. Press the RETURN soft key.

## 4.4 Manual Sounder Operation

Manual operation is useful for observing fish schools and bottom using a fixed gain setting.

The gain, range and range shift functions used together give you the means to select the depth you can see on the screen. The basic range can be thought of as providing a “window” into the water column and range shifting as moving the “window” to the desired depth.

### 4.4.1 Selecting the manual mode

1. If not displayed, press the [HIDE/SHOW] key to show the sounder soft keys.
2. Press the AUTO/D. BOX soft key to show the mode/frequency window.
3. Select OFF (MANUAL).
4. Press the RETURN soft key.

### 4.4.2 Selecting display range

Press the [RANGE +] or [RANGE -] key to select a range. The default ranges in feet, meters, fathoms and passi/braza are as below. Note that the range cannot be changed in the automatic sounder mode.

*Default sounder ranges*

Range 1	Range 2	Range 3	Range 4	Range 5	Range 6	Range 7	Range 8	
							ETR-6/10N	ETR-30N
15 ft	30 ft	60 ft	120 ft	200 ft	400 ft	1000 ft	4000 ft	4500 ft
5 m	10 m	20 m	40 m	80 m	150 m	300 m	1200 m	1500 m
3 fa	5 fa	10 fa	20 fa	40 fa	80 fa	150 fa	650 fa	900 fa
3 P/B	5 P/B	10 P/B	30 P/B	50 P/B	100 P/B	200 P/B	700 P/B	900 P/B

### 4.4.3 Adjusting the gain

Normally, set the gain to the point where excessive noise does not appear on the screen. Use a higher gain setting for greater depths and a lower setting for shallow waters.

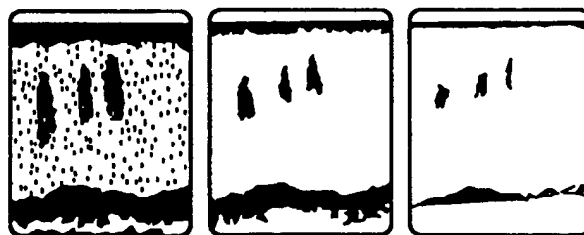

Gain too high      Gain proper      Gain too low

*Examples of proper and improper gain*

Press the [GAIN] key to show the gain window, and adjust the [ENTER] knob or trackball. Current level is shown on the bar, and the setting range is 0-100(%). Press the RETURN soft key to finish.

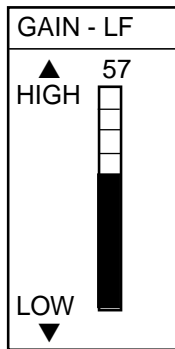

*Gain window*

**Note 1:** On the dual-frequency display, the gain can be independently set for LF and HF. Use the FREQ LF/HF soft key to select the frequency for which to adjust gain.

**Note 2:** Gain cannot be adjusted in the automatic sounder mode. The message "SOUNDER GAIN CANNOT BE CHANGED IN AUTO MODE" is displayed when you attempt to do so.

#### 4.4.4 Shifting the range

The basic range may be shifted up or down as desired by pressing the SHIFT soft key followed by adjusting the [ENTER] knob. Press the RETURN soft key to finish.

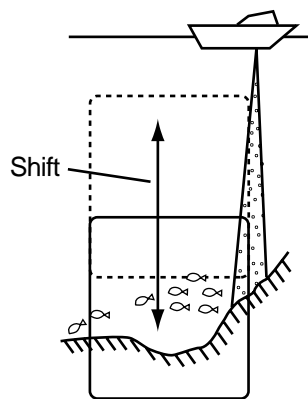

*Shift concept*

## 4.5 Measuring Depth, Time

The VRM measures the depth and the cross-hair cursor, time.

1. Rotate the [ENTER] knob to shift the VRM; counterclockwise to shift it downward, clockwise to shift it upward. You may also use the trackball to shift the VRM.
2. Roll the trackball horizontally to adjust the cross-hair cursor to measure time.

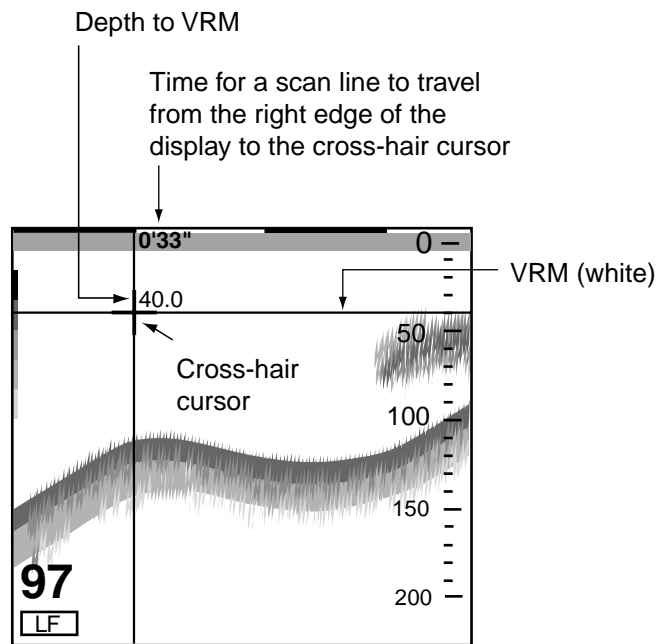

*How to measure depth and time*

**Note:** If, when the range setting is over 1000 ft (m, fa, p/b), the VRM indication and depth scale may overlap one another, shift the cross-hair cursor slightly to show them completely. Further, when the display is shifted, the depth scale may obscure the time indication.

## 4.6 Reducing Interference

Interference from other acoustic equipment operating nearby or other electronic equipment on your boat may show itself on the display as shown below.

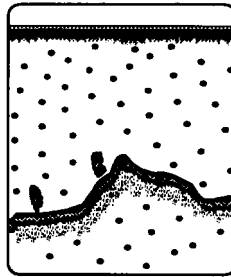

Interference from  
other sounder



Electrical interference

### *Types of interference*

To reduce interference, do the following:

1. Press the [MENU] key.
2. Press the SOUNDER MENU soft key.
3. Select NOISE LIMITER, then press the EDIT soft key to show the noise limiter window.

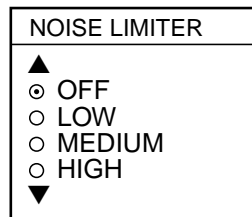

### *Noise limiter window*

4. Use the trackball to select the degree of suppression desired (LOW, MEDIUM, HIGH), or turn the noise limiter off.
5. Press the RETURN soft key followed by the [MENU] key to close the menu.

Turn the noise limiter circuit off when no interference exists, otherwise weak echoes may be missed.

## 4.7 Reducing Low Level Noise

Light-blue dots may appear over most of the screen. This is mainly due to sediment in the water, or noise. This noise can be suppressed by adjusting CLUTTER on the SOUNDER SETUP menu.



*Appearance of clutter*

When the automatic sounder mode is used, clutter is automatically adjusted. To reduce low level noise in manual sounder operation do the following:

1. Press the [MENU] key.
2. Press the SOUNDER MENU soft key.
3. Select CLUTTER, then press the EDIT soft key to show the clutter window.

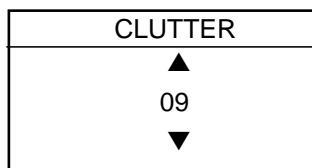

*Clutter window*

4. Adjust the trackball upward or downward to select clutter rejection level desired; 0 (OFF) through 16. The higher the number the higher the degree of suppression. Note that the clutter suppressor may erase weak echoes. Therefore, turn off the clutter when its use is not required.
5. Press the RETURN soft key followed by the [MENU] key to close the menu.

**Note:** Unlike the signal level feature, clutter does not reduce display colors. However, if you do not wish to change the relation between weak and strong echoes, use signal level instead.



## 4.8 Erasing Weak Echoes

Sediments in the water or reflections from plankton may be painted on the display in green or light blue. These weak echoes may be erased as below.

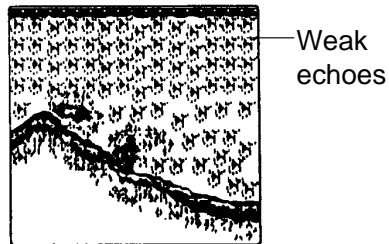

*Appearance of weak echoes*

1. Press the [MENU] key.
2. Press the SOUNDER MENU soft key.
3. Select SIGNAL LEVEL, and press the EDIT soft key to show the signal level window.

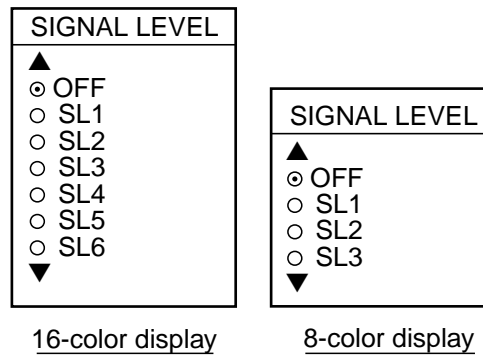

*Signal level window*

4. Use the trackball to select level of erasure or OFF as appropriate. The higher the number the stronger the echo that will be erased.
5. Press the RETURN soft key followed by the [MENU] key to close the menu.

**Note:** Unlike “clutter,” signal level reduces display colors. Therefore, if you do not wish to reduce colors, use clutter instead.

## 4.9 White Marker

The white marker functions to display a particular echo color in white. For example, you may want to display the bottom echo in white to discriminate fish echoes near the bottom.

1. Press the [MENU] key.
2. Press the SOUNDER MENU soft key.
3. Select WHITE MARKER, then press the EDIT soft key to open the white marker window.

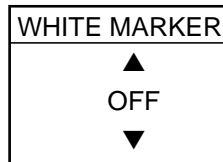

*White marker window*

4. Use the trackball to select the color to display in white. As you use the trackball, the number in the white marker window changes, the white marker on the echo strength bar shifts and the selected echo color is displayed in white.



*Color bar (16 color) when white marker function is active*

5. Press the RETURN soft key followed by the [MENU] key to close the menu.

To turn the white marker function off, display "OFF" in the white marker window.

## 4.10 Picture Advance Speed

The picture advance speed determines how quickly the vertical scan lines run across the screen. When selecting a picture advance speed, keep in mind that a fast advance speed will expand the size of the fish school horizontally on the screen and a slow advance speed will contract it.

The advancement speed may be set independent of or synchronized with ship's speed.

### 4.10.1 Advancement independent of ship's speed

1. Press the [MENU] key.
2. Press the SOUNDER MENU soft key.
3. Select PICTURE ADVANCE, and press the EDIT soft key to open the picture advance window.

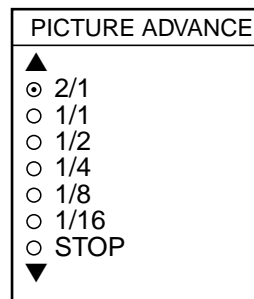

*Picture advance window*

4. Use the trackball to select speed desired. The fractions in the window denote the number of scan lines produced per transmission. For example, 1/8 means one scan line is produced every eight transmissions. STOP freezes the display and it is convenient for observing an echo.
5. Press the RETURN soft key followed by the [MENU] key to close the menu.

**Note:** When using the plotter/sounder combination display, advancement of the sounder picture may be temporarily interrupted while the plotter display is being shifted or its display range is being changed.

### 4.10.2 Advancement synchronized with ship's speed

With speed data provided by a speed-measuring device, picture advance speed may be set according to ship's speed, the ship's speed dependent mode. As shown in the figure below the horizontal scale of the display is not influenced by the change of ship's speed, thus the speed-dependent picture advance permits judgment of fish school size and abundance at any speed. The choice "SPD SENSING PRR" means the ship's speed dependent mode, where the PRR changes automatically with ship's speed.

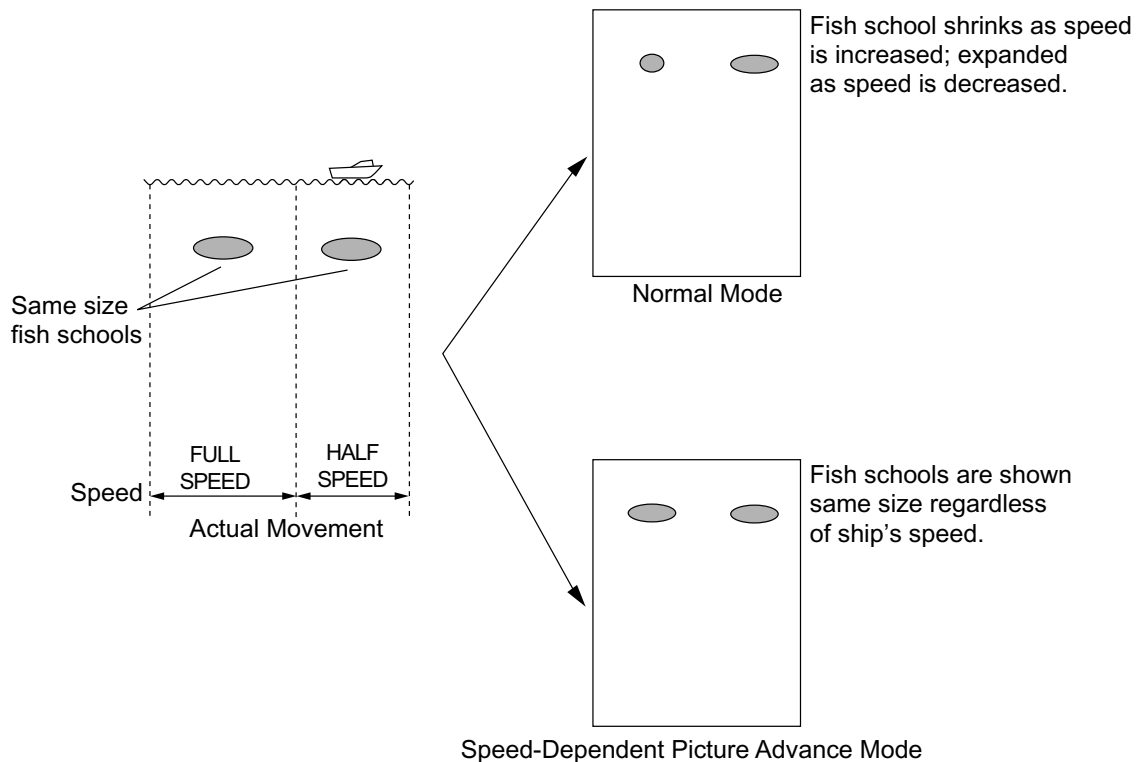

*How the speed-dependent picture advance mode works*

#### **Activating/deactivating the speed-dependent picture advance mode**

1. Press the [MENU] key followed by the SOUNDER MENU soft key.
2. Select PRR LEVEL.
3. Press the EDIT soft key to open the setting window.
4. Use the trackball to select SPD SENSING PRR.
5. Press the RETURN soft key followed by the [MENU] key to close the menu.

**Note:** Use the same speed data sentence (STG or STW) throughout the network for smooth advancement of the sounder picture. See the paragraph 6.5 for how to output data through the network.

## 4.11 Display Colors

You can select the number of colors and background color to display as follows:

1. Press the [MENU] key.
2. Press the SOUNDER MENU soft key.
3. Select HUE, then press the EDIT soft key to show the hue window.

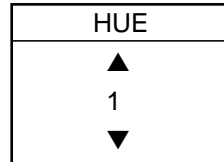

*Hue window*

4. Use the trackball to select hue number, referring to the table below. (You can see the result of your selection on the display.)

*Hue no. and background and echo colors*

Hue No.	Echo Color	Background Color
1	16 color	Blue
2	8 color	Blue
3	16 color	Dark blue
4	8 color	Dark blue
5	16 color	White
6	8 color	White
7	16 color	Black
8	8 color	Black
9	Monochrome yellow, eight intensities	

5. Press the RETURN soft key followed by the [MENU] key to close the menu.

## 4.12 Alarms

The sounder section has five conditions which generate audio and visual alarms: bottom alarm, fish alarm (bottom lock), fish alarm (normal) and water temperature alarm (temperature sensor required).

You may set up the sounder alarms on the ALARM menu, which may be displayed by pressing the [ALARM] key.

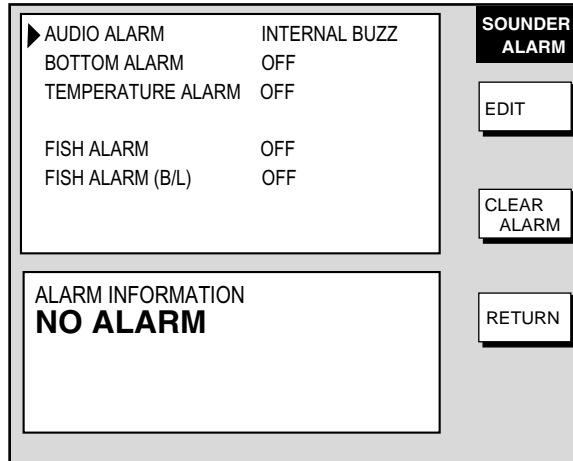

*Sounder alarm menu*

### 4.12.1 Audio alarm on/off

The audio alarm sounds whenever an alarm setting is violated. You can enable or disable the audio alarm as follows:

1. Press the [ALARM] key to show the ALARM menu.
2. Use the trackball to select ALARM AUDIO.
3. Press the EDIT soft key to show the audio alarm window.

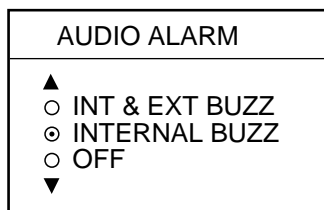

*Alarm audio window*

4. Use the trackball to select INT & EXT BUZZ (Internal + External alarm), INTERNAL BUZZ (Internal alarm) or OFF. External buzzer required to select "INT+EXT BUZZ." OFF globally turns the audio alarm on or off for all modes, including radar.
5. Press the ENTER soft key.
6. Press the [ALARM] key to close the menu.

### 4.12.2 Bottom alarm

The bottom alarm sounds when the bottom echo is within the alarm range set. To activate the bottom alarm, the depth must be displayed. Note that the bottom alarm is turned on or off reciprocally with the bottom alarm on the plotter alarm menu.

1. Press the [ALARM] key to show the ALARM menu.
2. Use the trackball to select BOTTOM ALARM.
3. Press the EDIT soft key to show the bottom alarm window.

BOTTOM ALARM
<div style="display: flex; align-items: center;"> <span style="margin-right: 5px;">▲</span> <input type="radio"/> ON            0000.0-0000.0 ft  <input checked="" type="radio"/> OFF  <span style="margin-left: 5px;">▼</span> </div>

*Bottom alarm window*

4. Use the trackball to select ON or OFF as appropriate. For ON, enter alarm range with the trackball and numeric keys: Adjust the trackball to select digit; hit appropriate numeric key to enter value.
5. Press the ENTER soft key or push the [ENTER] knob to register setting.
6. Press the [ALARM] key to close the menu.

### 4.12.3 Fish alarm

The fish alarm sounds when a fish echo is within the preset alarm range. Note that the sensitivity of the fish alarm can be set on the SOUNDER SYSTEM SETUP menu.

1. Press the [ALARM] key to show the ALARM menu.
2. Use the trackball to select FISH ALARM.
3. Press the EDIT soft key to show the fish alarm window.

FISH ALARM
<div style="display: flex; align-items: center;"> <span style="margin-right: 5px;">▲</span> <input type="radio"/> ON            0000.0-0000.0 ft  <input checked="" type="radio"/> OFF  <span style="margin-left: 5px;">▼</span> </div>

*Fish alarm window*

4. Use the trackball to select ON or OFF as appropriate. For ON, use the trackball and numeric keys to enter range: Adjust the trackball to select digit; hit the appropriate numeric key to enter value.
5. Press the ENTER soft key or push the [ENTER] knob to register setting.
6. Press the [ALARM] key to close the menu.

#### 4.12.4 Fish alarm (B/L)

The bottom-lock fish alarm sounds when a fish echo is within a predetermined distance from the bottom. Note that the sensitivity of the fish alarm can be set on the SOUNDER SYSTEM SETUP menu.

1. Press the [ALARM] key to show the ALARM menu.
2. Use the trackball to select FISH ALARM (B/L).
3. Press the EDIT soft key to show the fish alarm (B/L) window.

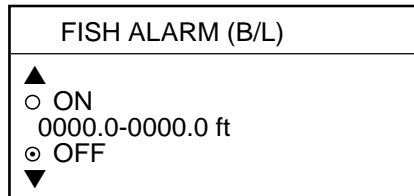

*Fish alarm (B/L) window*

4. Use the trackball to select ON or OFF as appropriate. For ON, use the trackball and numeric keys to enter range: Adjust the trackball to select digit; hit appropriate numeric key to enter value.
5. Press the ENTER soft key or push the [ENTER] knob to register setting.
6. Press the [ALARM] key to close the menu.



### 4.12.5 Water temperature alarm

There are two types of water temperature alarms: WITHIN RANGE and OUT OF RANGE. The WITHIN RANGE alarm sounds when the water temperature is within the range set, and the OUT OF RANGE alarm sounds when the water temperature is higher or lower than the range set. Note that the water temperature alarm is turned on or off reciprocally with the water temperature alarm on the plotter menu.

1. Press the [ALARM] key to show the ALARM menu.
2. Use the trackball to select TEMPERATURE ALARM.
3. Press the EDIT soft key to show the temperature alarm window.

TEMPERATURE ALARM	
▲	
<input type="radio"/>	WITHIN RANGE +000.0 - +000.0°F
<input type="radio"/>	OUT OF RANGE +000.0 - +000.0°F
<input checked="" type="radio"/>	OFF
▼	

*Water temperature alarm window*

4. Use the trackball to select WITHIN RANGE, OUT OF RANGE or OFF as numeric key to enter alarm range: Adjust the trackball to select digit; hit appropriate numeric key to enter value. To switch between plus and minus and vice versa use the +< ->- soft key.
5. Press the ENTER soft key or push the [ENTER] knob to register setting.
6. Press the [ALARM] key to close the menu.

### 4.12.6 When an alarm setting is violated...

When an alarm setting has been violated the buzzer sounds and the speaker icon appears in red. Press the [CLEAR] key to silence the alarm. At this time the color of the speaker icon changes from red to background color. You can see which alarm has been violated on the alarm menu display. In the example below the bottom alarm has been violated.

To see which alarm(s) has been violated:

1. Press the [ALARM] key. The name of the offending alarm is shown in the ALARM INFORMATION window.

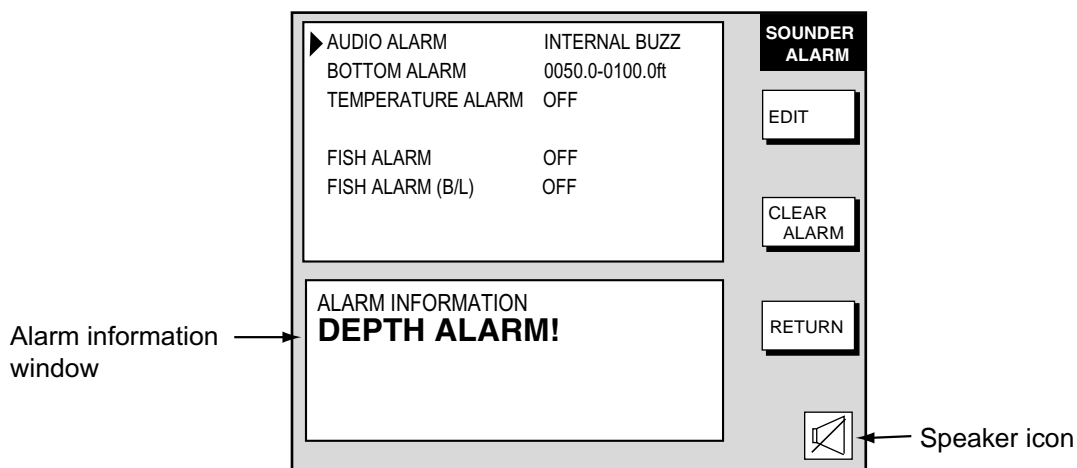

*Sounder alarm menu*

2. Press the CLEAR ALARM soft key to acknowledge the alarm (and silence the buzzer if it has not already been done with the [CLEAR] key). The color of the speaker icon changes from red to background color. The icon remains on the screen until the reason for the alarm is eliminated or the alarm is disabled. If more than one alarm has been violated, the message CONTINUE appears at the bottom of the alarm information window. In this case, press the NEXT INFO soft key to see which other alarms have been violated.

**Note:** The alarm icon is red when an alarm setting is violated, and changes to background color when the [CLEAR] key or CLEAR ALARM soft key is pressed. The color remains the same regardless of how many times another alarm is violated.

3. Press the [ALARM] key to close the menu.

**Alarm messages**

The table below shows the sounder alarm messages and their meanings.

*Sounder alarm messages and their meanings*

<b>Message</b>	<b>Meaning</b>
DEPTH ALARM!	Bottom alarm violated.
FISH ALARM!	Fish alarm violated.
TEMPERATURE ALARM!	Water temperature alarm violated.

**4.13 Water Temperature Graph**

The water temperature graph (appropriate sensor required) plots water temperature on the sounder display. (See the figure on page 4-3.) It can be turned on or off as below.

1. Press the [MENU] key to open the menu.
2. Press the SOUNDER MENU soft key.
3. Select TEMPERATURE GRAPH and press the EDIT soft key.
4. Select OFF (default setting) or ON as appropriate.
5. Press the ENTER soft key.
6. Press the [MENU] key to close the menu.

## 4.14 Changing Pulse Repetition Rate

Pulse repetition rate can be changed. Normally, the highest rate (20) is used. When in shallow waters, second reflection echoes may appear between surface and actual bottom echo. In this case lower the PRR level. The option "SPD SENSING PRR" means the ship's speed dependent mode, where the PRR changes automatically with ship's speed (required speed input.) For further information about the ship's speed dependent mode, see page 4-18.

1. Press the [MENU] key to open the menu.
2. Press the SOUNDER MENU soft key.
3. Select PRR LEVEL.
4. Press the EDIT soft key to open the setting window.
5. Use the trackball to select the rate for repetition.
6. Press the ENTER soft key followed by the [MENU] key to close the menu.

Too small setting reduces the number of pulse repetition. This may cause a problem to search fish schools. Select "20" unless multistage reflections appear on the display.

## 4.15 Interpreting the Sounder Display

### 4.15.1 Zero line

The zero line (sometimes referred to as the transmission line) represents the transducer's position, and moves off the screen when a deep phased range is used.

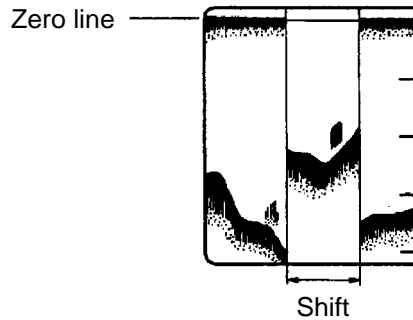

*Zero line*

### 4.15.2 Bottom echo

Echoes from the bottom are normally the strongest and are displayed in reddish-brown, but the color and width will vary with bottom composition, water depth, frequency, sensitivity, etc.

In a comparatively shallow depth, a high gain setting will cause a second or sometimes a third or a fourth echo to be displayed at the same interval between them below the first echo trace. This is because the echo travels between the bottom and the surface twice or more in shallow depths.

The color of the bottom echo can be used to help determine the density of the bottom materials (soft or hard). The harder the bottom, the wider the trace. If the gain is set to show only a single bottom echo on mud, a rocky bottom will show a second or third bottom return. The range should be chosen so the first and second bottom echoes are displayed when bottom hardness is being determined.

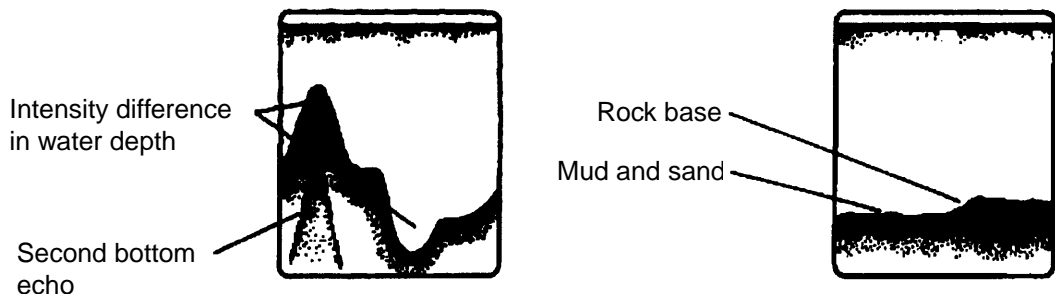

*Bottom echoes*

### 4.15.3 Fish school echoes

Fish school echoes will generally be plotted between the zero line and the bottom. Usually the fish school/fish echo is weaker than the bottom echo because its reflection property is much smaller compared to the bottom. The size of the fish school can be ascertained from the density of the display.

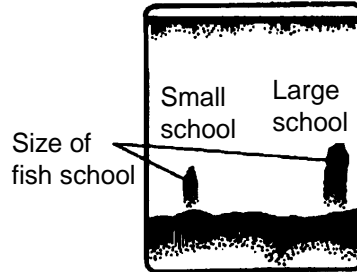

*Fish school echoes*

### 4.15.4 Surface noise/Aeration

When the waters are rough or the boat passes over a wake, surface noise may appear near the zero line. As surface turbulence is acoustically equivalent to running into a brick wall, the bottom echo will be displayed intermittently. Similar noise sometimes appears when a water temperature difference (thermocline) exists. Different species of fish tend to prefer different temperature zones, so the thermocline may be useful to help identify target fish. 200 kHz tends to show shallow thermoclines better than 50 kHz.

In rough waters the display is occasionally interrupted due to below-the-ship air bubbles obstructing the sound path. This also occurs when the boat makes a quick turn or reverses movement. Lowering the picture advance speed may reduce the interruption. However, reconsideration of the transducer installation may be necessary if the interruption occurs frequently.

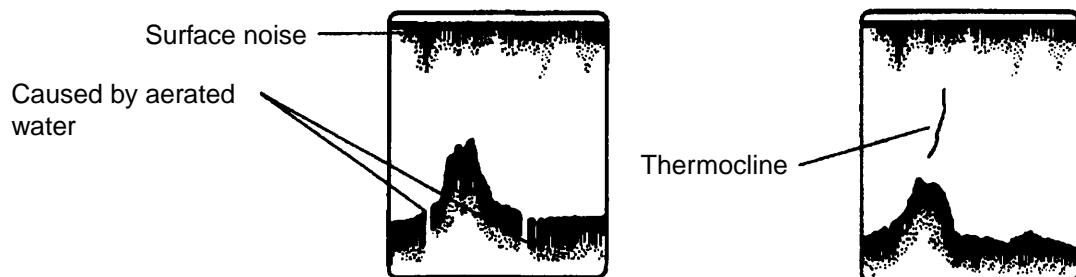

*Surface noise/aeration*

# 5. CUSTOMIZING YOUR UNIT

This chapter describes the various options which allow you to set up your unit to suit your needs. For mode-specific menus, e.g. radar, plotter and sounder, make sure that you select the appropriate display when making changes or viewing menu options.

## 5.1 General Setup

This paragraph shows you how to set up functions common to the plotter, radar and sounder displays. This is done on the GENERAL SETUP menu, which you may display from any mode. These items include language, key beep, units of measurement, data sources, etc.

1. Press the [MENU] key to display the main menu.
2. Press the SYSTEM CONFIGURATION soft key.
3. Press the GENERAL SETUP soft key.

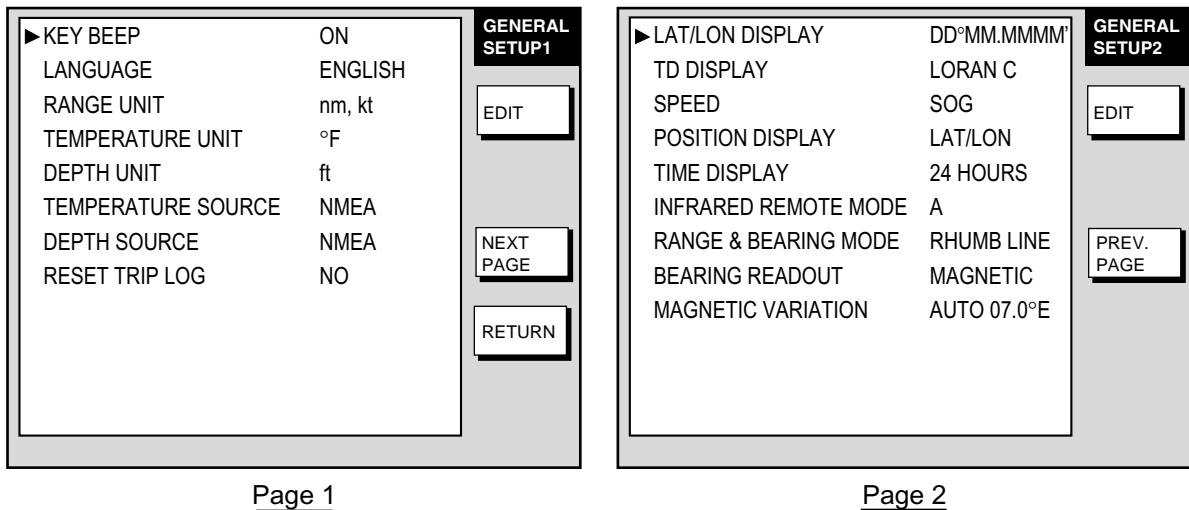

*General setup menu*

4. Press the NEXT PAGE or PREV. PAGE soft key to switch pages if necessary.
5. Use the trackball to select item.
6. Press the EDIT soft key.
7. Use the trackball to select option desired, then press the ENTER soft key.
8. Press the [MENU] key to close the menu.

## 5. CUSTOMIZING YOUR UNIT

### Contents of general setup menu

Item	Description	Settings
Key Beep	Turns key beep on/off.	On, Off
Language	Chooses menu language.	English, French, German, Italian, Portuguese, Spanish
Range Unit	Chooses unit of range and speed measurement.	nm, kt; km, km/h; sm, mph; nm & yd, kt; nm & m, kt; km & m, km/h; sm & yd, mph
Temperature Unit	Chooses unit of water temperature measurement.	°C, °F
Depth Unit	Chooses unit of depth measurement.	ft, m, fa, P/B (Passi/Braza)
Temperature Source	Chooses source of water temperature data.	ETR, NMEA. Select ETR to show water temperature data fed from the network sounder.
Depth Source	Chooses source of depth data.	ETR, NMEA. Select ETR to show depth data fed from the network sounder.
Reset Trip Log	Resets distance run to zero.	Yes, No
Lat/Lon Display	Chooses how many digits (or seconds) to display after decimal point in latitude and longitude position.	DD°MM.MM', DD°MM.MMM', DD°MM.MMMM', DD°MM'SS.S"
TD Display	Chooses TD type.	Loran C, Decca
Speed	Chooses speed format to display.	SOG (Speed over ground), STW (Speed through water)
Position Display	Chooses position display format.	LAT/LON, TD
Time Display	Chooses time notation.	12 hours, 24 hours
Infrared Remote Mode	A remote controller can be set exclusively for use with a specific display unit, in the case of multiple NavNet display units. For further details see the Installation Manual.	A, B, C, D
Range & Bearing Mode	Chooses how to calculate range and bearing.	<b>Rhumb Line:</b> Straight line drawn between two points on a nautical chart. <b>Great Circle:</b> Shortest course between two points on the surface of the earth.

(Continued on next page)



*Contents of general setup menu (con't from previous page)*

Item	Description	Settings
Bearing Readout	Chooses bearing display format for course, course over ground and cursor bearing.	True, Magnetic
Magnetic Variation	The magnetic variations for all areas of the earth are preprogrammed into this unit. The preprogrammed variation is accurate for most instances, however you may wish to manually enter a variation. For manual input, select Manual, hit the EDIT soft key, enter value, then hit the ENTER soft key to set. "AUTO" requires position data.	Auto, Manual

## 5.2 Radar Setup

This paragraph explains how to customize the radar display to suit your operational needs.

### 5.2.1 Radar display setup

The radar display may be set up from the RADAR DISPLAY SETUP menu, which contains items such as EBL reference and cursor position format.

1. Press the [MENU] key to show the main menu.
2. Press the RADAR DISPLAY SETUP soft key.

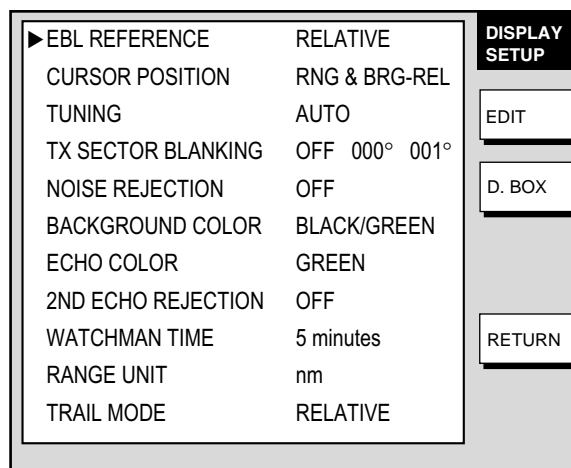

*Radar display setup menu*

5. CUSTOMIZING YOUR UNIT

Contents of radar display setup menu

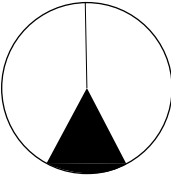
Item	Description	Settings
EBL Reference	References EBL bearing, shown in the EBL data box, to North (True) or heading (Relative). Relative with no heading input. True only in course-up, north-up and true motion.	True, Relative
Cursor Position	Chooses how to display cursor position.  <b>Note:</b> "RNG & BRG-TRUE" requires heading data, true bearing. Reverts to relative bearing when heading data is lost.	<u>LAT/LON:</u> Lat/Long position of cursor <u>TD:</u> Loran C or Decca TDs <u>RNG &amp; BRG-REL:</u> Range and bearing in relative bearing. <u>RNG &amp; BRG-TRUE:</u> Range and bearing in true bearing.
Tuning	Selects receiver tuning method. For further details see the paragraph "2.6 Tuning."	Auto, Manual
TX Sector Blanking	Turns on/off dead sector graphic, which shows area where no echoes are transmitted. To set sector, select ON, then enter range. Max. sector is 135°. Dashed lines mark the dead sector. Note that noise may occasionally appear in the TX sector when the echo trail feature is turned on.   Dead sector	On, Off
Noise Rejection	Electrical noise, appearing on the screen as "speckles," may be suppressed with the noise rejector. Note that some forms of interference cannot be suppressed.	Off, Low, High

(Con't on next page)

Contents of radar display setup menu (con't from previous page)

Item	Description	Settings
Background Color	Chooses colors of background, range rings and characters. Effective when HUE soft key is set for MANUAL.	<u>Black/Green</u> Background: Black Rings: Green Characters: Green <u>Black/Red</u> Background: Black Rings: Green Characters: Red <u>Blue/White</u> Background: Blue Rings: White Characters: White <u>DK Blue/White</u> Background: Dark Blue Rings: Green Characters: Red <u>White/Green</u> Background: White Rings: Green Characters: Green
Echo Color	Chooses echo color.	Yellow, Green, Multi-color. (Multi-color shows echoes in red, yellow or green in order of descending strength.)
2ND Echo Rejection	Reduces second-trace echoes. See the paragraph "2.24 Suppressing Second-trace Echoes."	On, Off
Watchman Time	Sets watchman stand-by period. For further details see the paragraph " 2.23 Watchman."	5, 10, 20 minutes
Range Unit	Select unit of range measurement.	nm, km, sm
Trail Mode	Sets echo trail reference.  <b>Note:</b> Relative trail is available in all presentation modes except true motion. True trail is available in all modes.	<b>True:</b> Echo trails plotted in actual courses and speeds. Requires compass signal and speed input. <b>Relative:</b> Echo trails move relative to own ship.

## 5. CUSTOMIZING YOUR UNIT

### 5.2.2 Radar range setup

You may choose the radar ranges you wish to use, from the RADAR RANGE SETUP menu. After choosing the ranges desired, change the range with the [RANGE] key to activate range settings. Available ranges depends on the radar used.

At least two ranges must be turned on. When less than two ranges are turned on you cannot escape from the RADAR RANGE SETUP menu.

Note that this function is not available with the GD-1900C.

1. Press the [MENU] key to show the main menu.
2. Press the RADAR RANGE SETUP soft key to show the RADAR RANGE SETUP menu.

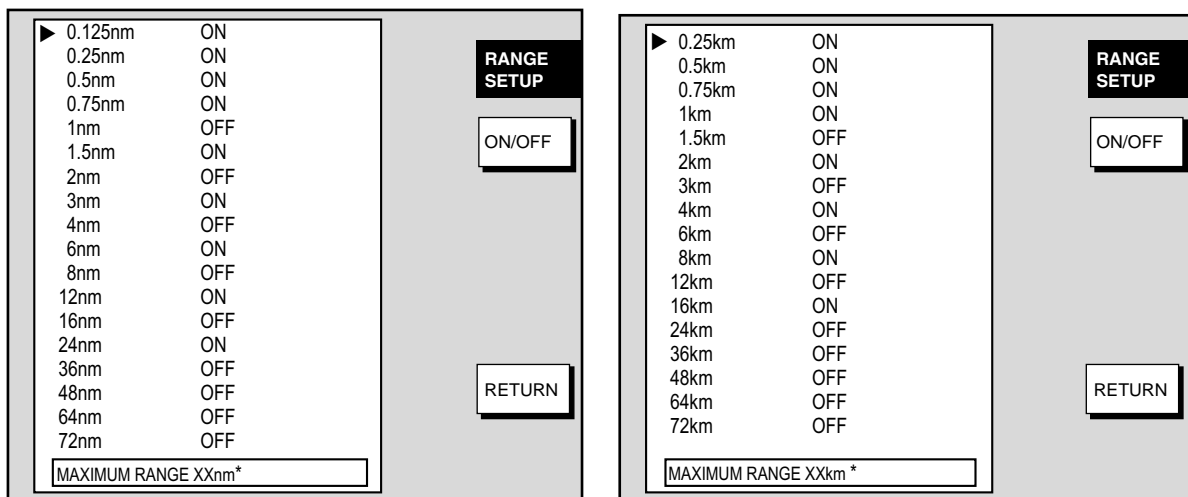

\* = Max. range depends on network radar used and is set on the network radar at installation.

Range unit: nm

Range unit: km

#### *Radar range setup menu*

3. Use the trackball to select the range which you want to turn on or off.
4. Press the ON/OFF soft key to turn a range on or off as appropriate.
5. Press the RETURN soft key to register settings.
6. Press the [MENU] key to close the menu.

Model	Maximum Range
1823C	24 nm, km, sm
1833C	36 nm, km, sm
1933C	48 nm, km, sm
1943C	64 nm, km, sm
1953C	72 nm, km, sm

### 5.2.3 Function key setup

The function keys provide one-touch execution of a desired function. The default radar function key settings are as shown in the table below.

Function Key	Default Function	Function Key Label
1	Turn heading line off.	HL
2	Turn range rings on/off.	RNG
3	Turn echo trail on/off.	TRL
4	Turn display offcenter on/off.	SFT
5	Radar source	RSR

If the above settings are not to your liking you may change them as follows:

1. Press the [MENU] key.
2. Press the FUNCTION KEY SETUP soft key.

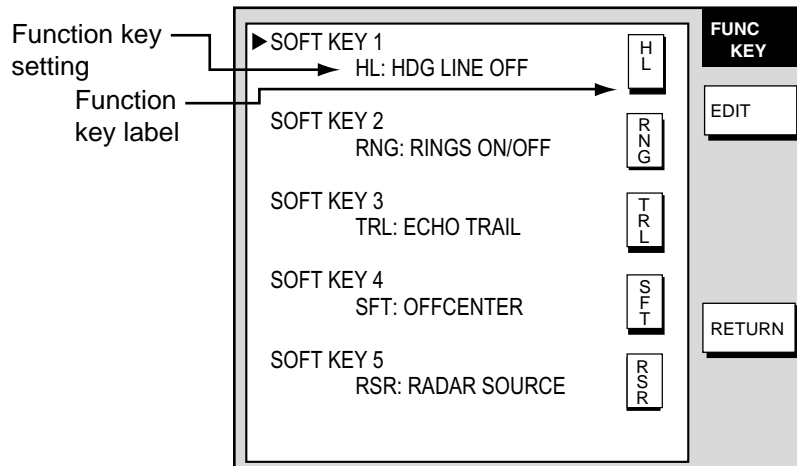

*Radar function key menu*

3. Select the function key you want to program, then press the EDIT soft key.

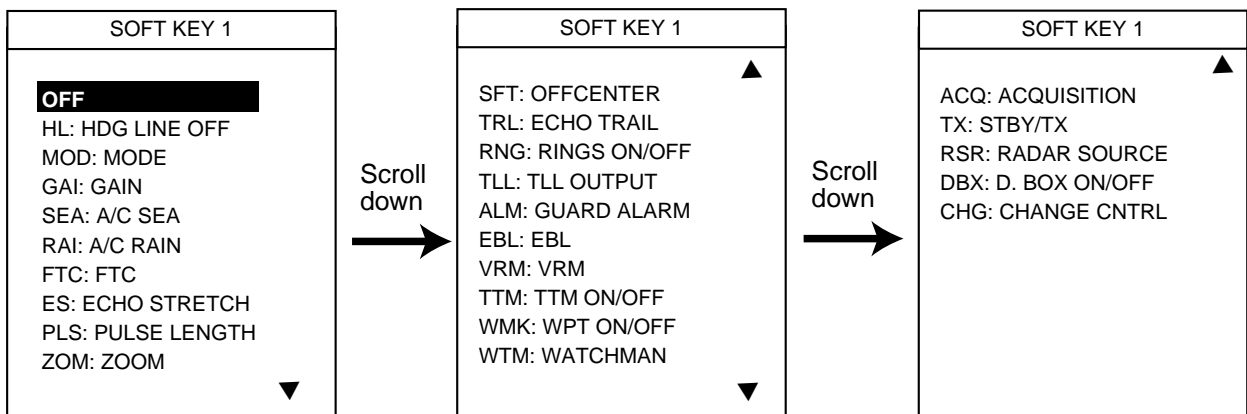

*Radar function key options*

## 5. CUSTOMIZING YOUR UNIT

4. Select function desired with the trackball, then press the ENTER soft key or [ENTER] knob to register your selection.
5. Press the [MENU] key to close the menu.

### Radar function keys

Menu Item	Function	Function Key Label
OFF	Assigns no function.	—
HL: HDG LINE OFF	Turns heading line off.	HL
MOD: MODE	Selects presentation mode.	MOD
GAI: GAIN	Shows gain sensitivity adjustment window.	GAI
SEA: A/C SEA	Shows A/C SEA adjustment window.	SEA
RAI: A/C RAIN	Shows A/C RAIN adjustment window.	RAI
FTC: FTC	Displays FTC window. Available with Model 1700 series radar. Inoperative otherwise.	FTC
ES: ECHO STRETCH	Turns echo stretch on/off.	ES
PLS: PULSE LENGTH	Sets pulselength (long or short).	PLS
ZOM: ZOOM	Turns zoom on/off.	ZOM
SFT: OFFCENTER	Press to shift display center to cursor location. Press again to turn shift off and return cursor to display center.	SFT
TRL: ECHO TRAIL	Starts/stops echo trails.	TRL
RNG: RINGS ON/OFF	Turns range rings on/off.	RNG
TLL: TLL OUTPUT	Outputs cursor position, in NMEA format, to navigator.	TLL
ALM: GUARD ALARM	Displays alarm soft keys.	ALM
EBL: EBL	Switches control between EBL1 and EBL2 with each press.	EBL
VRM: VRM	Switches control between VRM1 and VRM2 with each press.	VRM
TTM: TTM ON/OFF	Turns TTM (Tracked Target Message) display on/off.	TTM
WMK: WPT ON/OFF	Turns waypoint marker on/off.	WMK
WTM: WATCHMAN	Turns watchman on/off.	WTM
ACQ: ACQUISITION	Acquires and tracks cursor-selected target. (Requires ARP-equipped Model 1800/1900 series network radar.)	ACQ
TX: STBY/TX	Toggles between standby and transmit	TX
RSR: RADAR SOURCE	Selects source for radar picture.	RSR
DBX: D. BOX ON/OFF	Turns data boxes on/off.	DBX
CHG: CHANGE CNTRL	Changes display control in combination display.	CHG

**Note:** To use CHANGE CNTRL set it on all displays, with the same soft key number.

## 5.3 Plotter Setup

This paragraph provides the information necessary for setting up the plotter display.

### 5.3.1 Navigation options

Navigation options, for example, waypoint switching method, may be set on the PLOTTER SETUP menu.

1. Show the plotter display, then press the [MENU] key open the main menu.
2. Press the PLOTTER SETUP soft key.

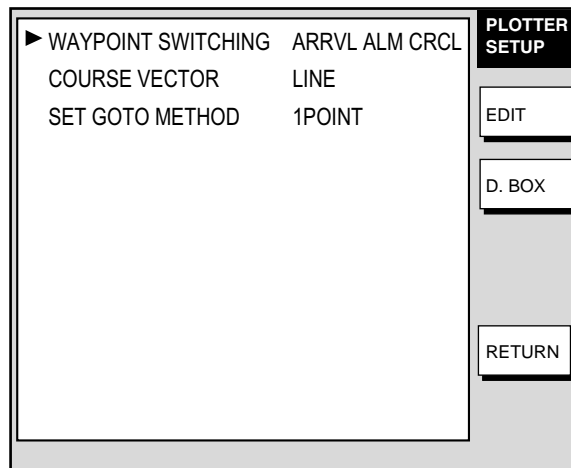

*Plotter setup menu*

#### Contents of plotter setup menu

Item	Description	Settings
Waypoint Switching	Chooses waypoint switching method. See "switching waypoints" on page 3-50.	Perpendicular, Arrvl Alm Crcl, Manual
Course Vector	You may extend a line from the own ship position to show ship's course. It may be a vector (length depends on ship's speed) or a simple line (course bar).	Line, Vector, Off
Set GOTO Method	Sets the method by which to navigate to a quick point. See "3.10.1 Navigating to a quick point."	1 Point, 35 Points, 35 Pts/Port Service
D. BOX (soft key)	Sets up data boxes. See paragraph 5.5.	

### 5.3.2 Function key setup

The function keys provide one-touch execution of a desired function. The default plotter function key settings are as shown in the table below.

Function Key	Default Function	Function Key Label
1	Start/stop recording/plotting own ship's track.	TRK
2	Edit mark/line.	EML
3	Ruler (measure range and bearing between two points).	RUL
4	Add new waypoint.	ADD
5	Alphanumeric waypoint list.	APL

If the above settings are not to your liking you may change them as follows:

1. Press the [MENU] key.
2. Press the FUNCTION KEY SETUP soft key.

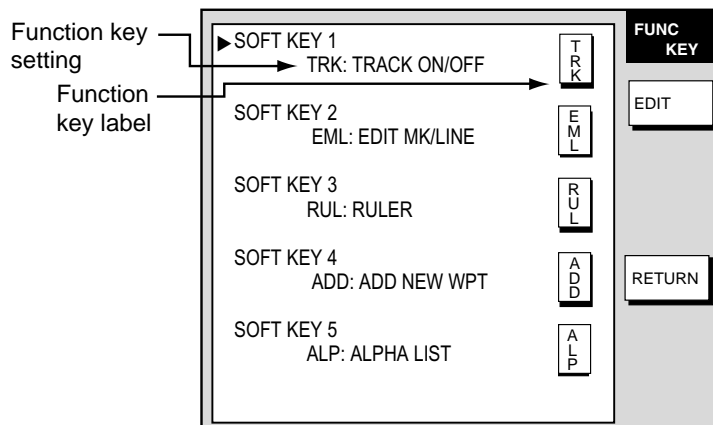

*Plotter function key menu*

3. Select the soft key you want to program, then press the EDIT soft key. A menu shows the functions available and the current selection is highlighted.

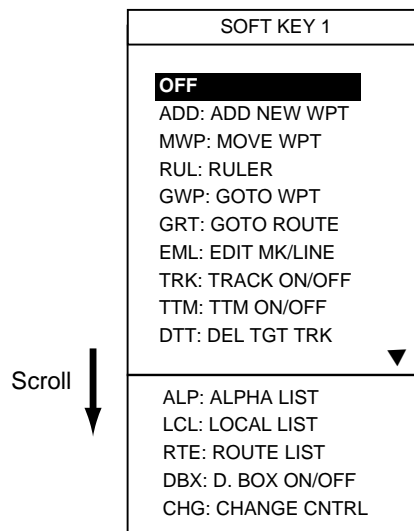

*Plotter function key options*



4. Select function desired with the trackball, then press the ENTER soft key or [ENTER] knob to register your selection.
5. Press the [MENU] key to close the menu.

Plotter function keys

Menu Item	Function	Function Key Label
OFF	Assigns no function.	—
ADD: ADD NEW WPT	Registers waypoint at cursor position. Place cursor for waypoint location, then press function key.	ADD
MWP: MOVE WPT	Moves selected waypoint to different position. Select waypoint, press function key, select new position, then press the [ENTER] knob.	MWP
RUL: RULER	Measures range and bearing between two points. Press START POINT soft key to change starting point if necessary. Range and bearing between two points appears at the top of the screen.	RUL
GWP: GOTO WPT	Specify waypoint to set as destination. Enter waypoint name in window, then press the ENTER soft key.	GWP
GRT: GOTO ROUTE	Specify route to follow. Enter route name in window, then press the ENTER soft key.	GRT
EML: EDIT MK/LINE	Displays mark & line menu. Press appropriate soft key to access menu item.	EML
TRK: TRACK ON/OFF	Each press starts or stops recording/plotting own ship's track.	TRK
TTM: TTM ON/OFF	Turns TTM (target track) display on/off.	TTM
DTT: DEL TGT TRACK	Erases all TTM track.	DTT
ALP: ALPHA LIST	Displays waypoint alphanumeric list.	ALP
LCL: LOCAL LIST	Displays waypoint local list.	LCL
RTE: ROUTE LIST	Displays route list.	RTE
DBX: D. BOX ON/OFF	Shows/hides data boxes.	DBX
CHG: CHANGE CNTRL	Changes control in combination screen.	CHG

**Note:** To use CHANGE CNTRL set it on all displays, with the same soft key number.

## 5.4 Chart Setup

This paragraph shows you how to setup digital charts, from offsetting chart position to turning chart attributes on or off.

### 5.4.1 Chart offset

In some instances position may be off by a few seconds. For example, the position of the ship is shown to be at sea while it is in fact moored at a pier. You can compensate for this error by offsetting chart position as shown in the procedure below.

1. Show the plotter display, then press the [MENU] key followed by the CHART SETUP and CHART OFFSET soft keys.

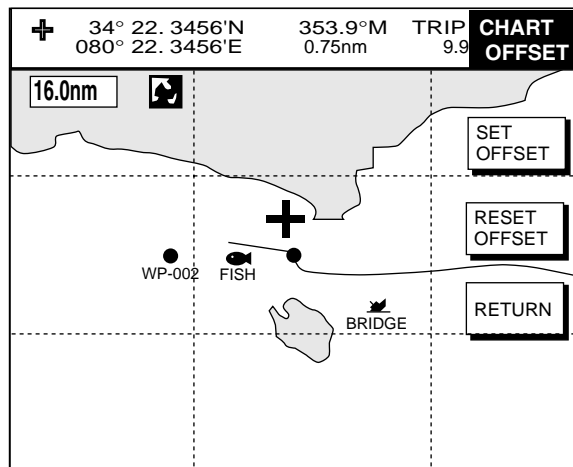

*Plotter display, chart offset selected*

2. Use the trackball to place the cursor at the correct latitude and longitude position of own ship.
3. Press the SET OFFSET soft key.
4. Press the [MENU] key to close the menu. The “chart offset icon” (☒) appears at the top of the display.

To cancel chart offset, press the RESET OFFSET soft key at step 3 in the above procedure.

### 5.4.2 FURUNO, NavCharts™ chart attributes

FURUNO, NavCharts™ chart attributes may be turned on or off from the CHART DETAILS menu, which you may display as follows:

1. Press the [MENU] key.
2. Press the CHART SETUP and CHART DETAILS soft keys.

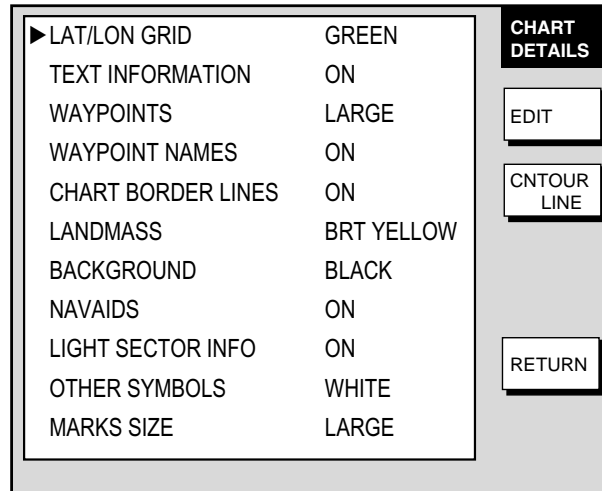

*Chart details menu (FURUNO, NavCharts™)*

## 5. CUSTOMIZING YOUR UNIT

### Contents of chart details menu (FURUNO, NavCharts™)

Item	Description	Settings
Lat/Lon Grid	Latitude and longitude grids	Red, yellow, green, light-blue, purple, blue, white, Off
Text Information	Geographic place, name	On, Off
Waypoints	Waypoint size	Large, Small, Off
Waypoint Names	Waypoint name	On, Off
Chart Border Lines	Border lines (indices)	On, Off
Landmass	Landmass color, brightness	Bright, Dim: Red, yellow, green, light-blue, purple, blue, white. Off
Background	Chart background color	White, Black
Nav aids	Nav aids data on NavCharts™; lighthouse data on FURUNO charts	On, Off
Light Sector Info	Lighthouse viewing sector	On, Off
Other Symbols	Other map symbols	Red, yellow, green, light-blue, purple, blue, white, Off
Marks Size	Marks size	Large, Small
CNTOUR LINE soft key (See next page.)	Depth < 10 m	On, off, red, yellow, green, light-blue, purple, blue, white
	Depth = 10 m	On, off, red, yellow, green, light-blue, purple, blue, white
	Depth > 10 m	On, off, red, yellow, green, light-blue, purple, blue, white
	Depth Info	On, off, red, yellow, green, light-blue, purple, blue, white

**CNTOUR LINE soft key**

1. Press the [MENU] key.
2. Press the CHART SETUP and CHART DETAILS soft keys.
3. Press the CNTOUR LINE soft key.

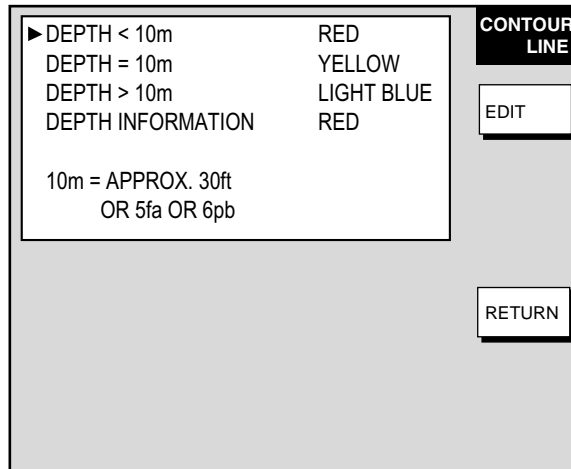

*Contour line menu (FURUNO, NavCharts™)*

**5.4.3 C-MAP chart attributes**

C-MAP chart attributes may be turned on or off from the CHART DETAILS menu as follows:

1. Press the [MENU] key.
2. Press the CHART SETUP and CHART DETAILS soft keys.

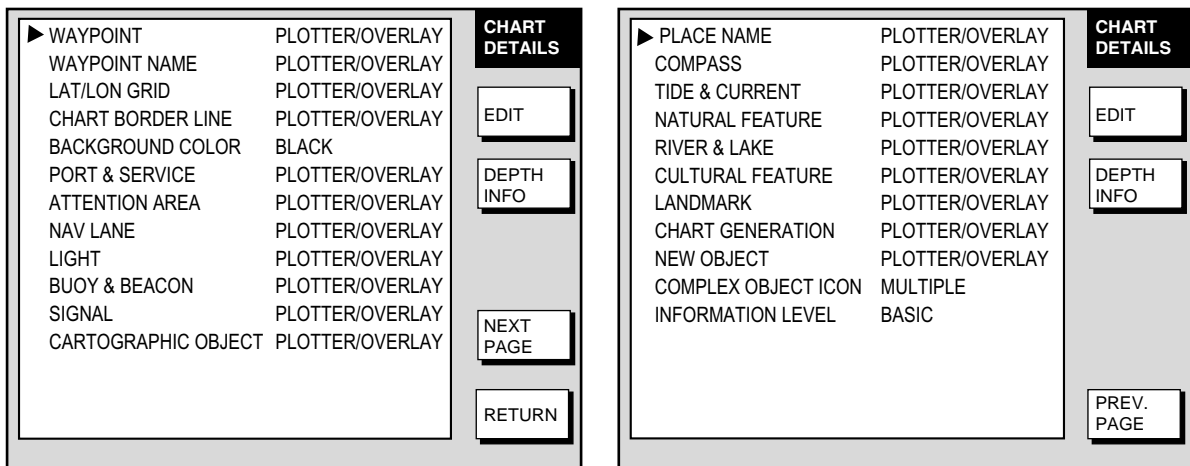

*Chart details menu (C-MAP)*

## 5. CUSTOMIZING YOUR UNIT

### Contents of chart details menu (C-MAP)

<b>Item</b>	<b>Description</b>	<b>Settings</b>
Waypoint	Waypoint display	Plotter/Overlay, Plotter, Off
Waypoint Name	Waypoint name	Plotter/Overlay, Plotter, Off
Lat/Lon Grid	Latitude and longitude grids	Plotter/Overlay, Plotter, Off
Chart Border Line	Border lines (indices)	Plotter/Overlay, Plotter, Off
Background Color	Chart background color	White, Black
Port & Service	Port services icon display	Plotter/Overlay, Plotter, Off
Attention Area	Attention area icon display	Plotter/Overlay, Plotter Plotter/Contour, Off
Nav Lane	Navigation lanes	Plotter/Overlay, Plotter, Off
Light	Lighthouse icon, sector	Plotter/Overlay, Plot/No Sector, Off
Buoy & Beacon	Buoys, beacons display	Plotter/Overlay, Plotter, Off
Signal	Signals category icon	Plotter/Overlay, Plotter, Off
Cartographic Object	Cartographic objects category icon	Plotter/Overlay, Plotter, Off
Place Name	Geographic names	Plotter/Overlay, Plotter, Off
Compass	Compass category icons	Plotter/Overlay, Plotter, Off
Tide & Current	Tide display	Plotter/Overlay, Plotter, Off
Natural Feature	Land outline	Plotter/Overlay, Plotter, Off
River & Lake	Rivers and lakes	Plotter/Overlay, Plotter, Off
Cultural Feature	Cultural features icons	Plotter/Overlay, Plotter, Off
Landmark	Landmarks category icons	Plotter/Overlay, Plotter, Off
Chart Generation	Chart generation category icons	Plotter/Overlay, Plotter, Off
New Object	New object category icons	Plotter/Overlay, Plotter, Off
Complex Object Icon	Single or multiple icon for object composed of several icons	Multiple, Single
Information Level	Basic or detailed data for objects	Basic, Detailed

(Con't on next page)

*Contents of chart details menu for C-MAP (con't from previous page)*

Item	Description	Settings
DEPTH INFO soft key (See below.)	Bathymetric Line	Plotter/Overlay, Plotter, Off
	Spot Sounding	Plotter/Overlay, Plotter, Off
	Bottom Type	Plotter/Overlay, Plotter, Off
	Depth Area Limit	0-99999 ft (m, fa, P/B)
	Bathymetric Range	0-99999 ft (m, fa, P/B)

**Settings description**

**Basic:** Shows basic characteristics of objects.

**Detailed:** Shows detailed characteristics of objects.

**Multiple:** Shows multiple icons for complex objects.

**Off:** Turns item off.

**On:** Turns item on.

**Plotter:** Shows item on plotter display.

**Plot/No Sector:** Shows item on plotter display. Sector not shown.

**Plotter/Contour:** Shows contour on plotter display.

**Plotter/Overlay:** Shows item on plotter and overlay displays.

**Single:** Shows single icon for complex objects.

**DEPTH INFO soft key**

1. Press the [MENU] key.
2. Press the CHART SETUP and CHART DETAILS soft keys.
3. Press the DEPTH INFO soft key.

**Note:** The bathymetric range setting allows you to control the color (Dark blue, light blue or white) associated to user assigned depths. Any contour line area that contains a depth that is LOWER than the first number will be shown in dark blue.

Any contour line area that contains a depth

BETWEEN the first and second number will be shown as light blue. Any contour line area that contains a depth that is HIGHER than the second number will be white. For example, if the bathymetric range setting is set to 00010~00050 ft, all contour areas that contain any depth less than 10 ft deep would be shaded dark blue, all depth contour areas that contain a depth between 10 and 50 feet will be shaded light blue, and all contour areas over 50 feet deep will be white.

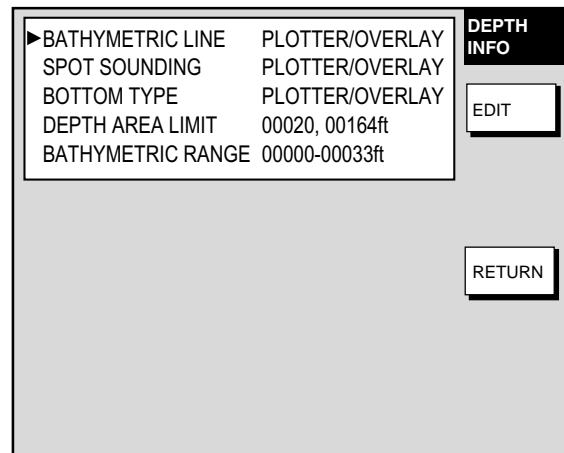

*Depth info menu (C-MAP)*

## 5.5 Data Boxes Setup

You may select the data to show in the data boxes for the plotter, radar and sounder displays. Six boxes may be displayed in case of small size data box and two for large size data box.

1. Display the radar, plotter or sounder display, whichever you want to set.
2. Press the [MENU] key to open the main menu.
3. Press one of the following sets of soft keys depending on the display selected at step 1.

**Plotter mode:** PLOTTER SETUP, D. BOX

**Radar mode:** RADAR DISPLAY SETUP, D. BOX

**Sounder mode:** SOUNDER MENU, D. BOX

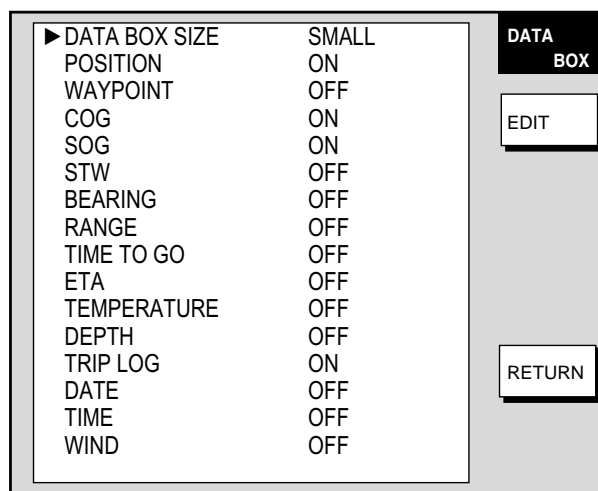

*Data box menu*

4. Use the trackball to select an item, then press the EDIT soft key.
5. Select ON or OFF as desired.
6. Press the ENTER soft key or the [ENTER] knob to register your selection. Six items may be set to ON for small data boxes; two for large data boxes.
7. Repeat steps 4-6 to turn other items on or off.
8. Press the [MENU] key to close the menu.



## 5.6 Hot Page Setup

Six user-arrangeable hot pages are provided for quick selection of desired display. If the default hot pages are not to your liking you may change them as shown below.

1. Press the [MENU] key followed by pressing the SYSTEM CONFIGURATION, SYSTEM SETUP, HOT PAGE & NAV DISP SETUP and HOT PAGE SETUP soft keys in that order.
2. Use the trackball to select the hot page number to set, then press the EDIT soft key. The "SELECT SCREEN TYPE" window appears.

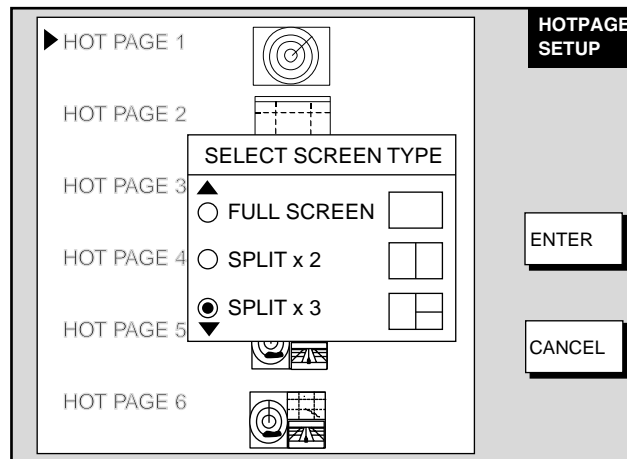

*Hot page setup menu*

3. Use the trackball to select screen type desired among FULL SCREEN, SPLIT X 2 and SPLIT X 3 and push the [ENTER] knob.

For the full-screen display, rotate the [ENTER] knob to select screen desired, then press the [ENTER] knob. If you selected a split screen, for example, SPLIT X 3, the display now looks as in the figure below.

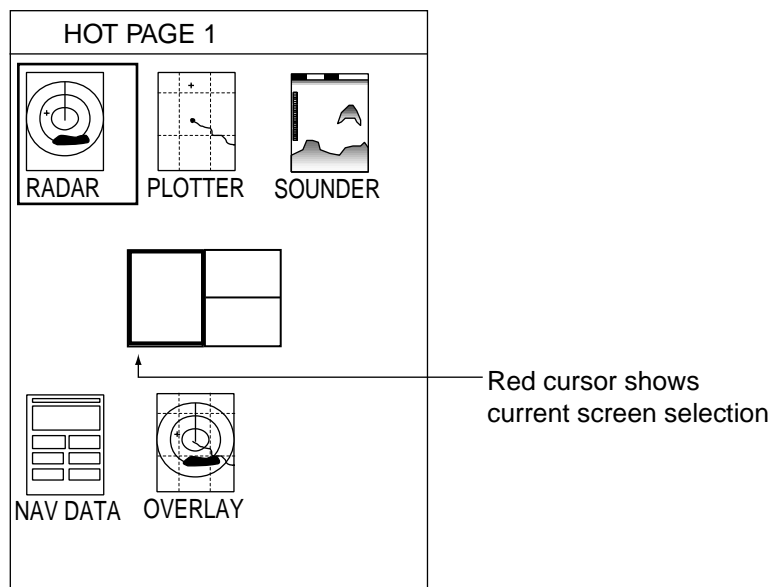

*Hot page setup menu, SPLIT X 3 screen, main screen selection*

## 5. CUSTOMIZING YOUR UNIT

4. Rotate the [ENTER] knob to select a main screen, then press the [ENTER] knob. For example, select the radar display. Your choice is then shaded to show that it has been selected.

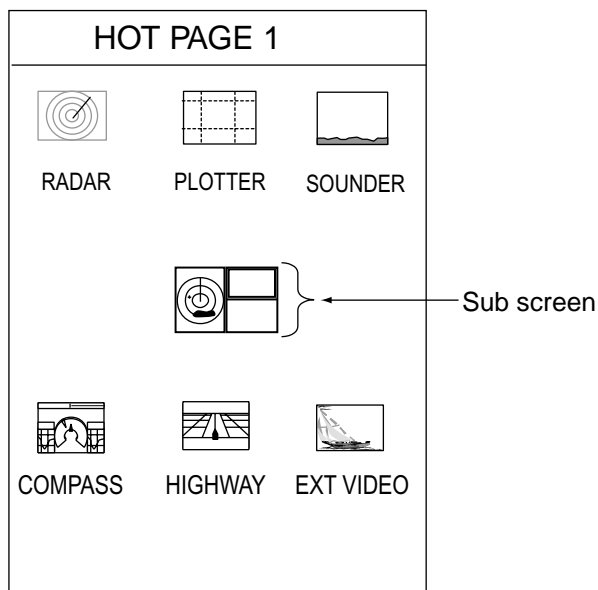

*Hot page setup menu, SPLIT X 3 screen, sub screen selection*

5. Rotate the [ENTER] knob to select the screen to show at the top right 1/4 screen, then press the [ENTER] knob or the ENTER soft key.
6. Rotate the [ENTER] knob to select the screen to show at the bottom right 1/4 screen, then press [ENTER] knob or the ENTER soft key.

**Note:** The SELECT WINDOW soft key functions to select the window to process.

7. Press the [MENU] key to close the menu.

## 5.7 Navigator Setup

This section provides the information necessary for selecting the type of navigator connected to your plotter.

### 5.7.1 Navigation data source

The NAV SETUP menu mainly selects the source of nav data. For GPS receiver other than the GP-310B/320B, speed averaging and local time

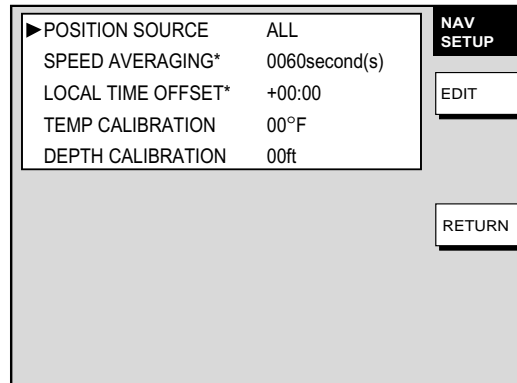

\* For GPS receiver other than GP-310B/320B.

Nav setup menu

offset (to use local time) are also available. Press the [MENU] key followed by the SYSTEM CONFIGURATION, NAV OPTION and NAV SOURCE SETTINGS soft keys to display this menu.

#### Contents of nav setup menu

Item	Description	Settings
Position Source	Chooses source of position data.	<b>FURUNO BB GPS:</b> GPS Receiver GP-310B/320B <b>GP:</b> GPS navigator (via NETWORK or NMEA port) <b>LC:</b> Loran C navigator (via NETWORK or NMEA port) <b>ALL:</b> Multiple navaid connection (via NETWORK or NMEA port)
Speed Averaging	Calculation of ETA is based on average ship's speed over a given period. If the period is too long or too short, calculation error will result. Change this setting if calculation error occurs. The default setting is suitable for most conditions.	0-9999 seconds
Local Time Offset	GPS uses UTC time. If you would rather use local time, enter the time difference between it and UTC. This setting is not necessary when the time difference is entered at the GPS navaid which is connected. Use the + <- -> - soft key to switch from plus to minus and vice versa.	-13:30 to +13:30 hours
Temp Calibration	Offsets NMEA water temperature data.	-40°F - 40°F
Depth Calibration	Offsets NMEA depth data.	-15 - +90 ft

### 5.7.2 GPS receiver setup (Set equipped with GP-310B/320B)

The GPS SETUP menu sets up the GPS Receiver GPS-310B/320B. Press the [MENU] key followed by the SYSTEM CONFIGURATION, NAV OPTION and GPS SENSOR SETTINGS soft keys to display this menu.

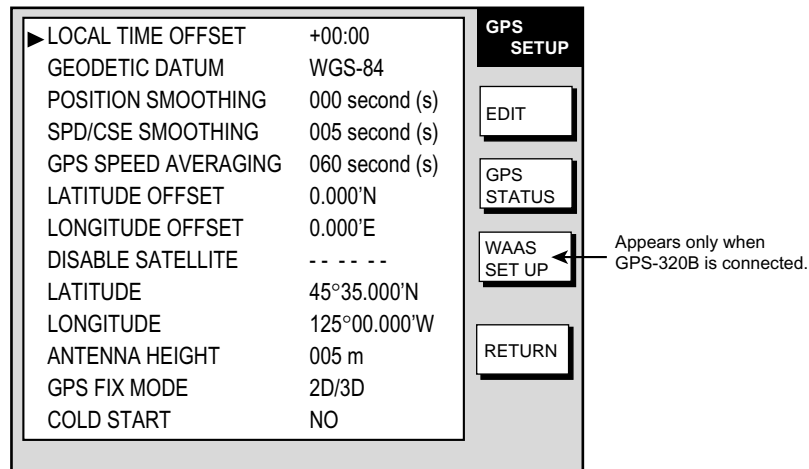

*GPS setup menu*

*Contents of GPS setup menu*

Item	Description	Settings
Local Time Offset	GPS uses UTC time. If you would rather use local time, enter the time difference between it and UTC. Use the +< - ->- soft key to switch from plus to minus and vice versa.	-13:30 to +13:30 hours
Geodetic Datum	Geodetic datum is a reference for geodetic survey measurements consisting of fixed latitude, longitude and azimuth values associated with a defined station of reference. You must have the correct geodetic datum selected in your plotter so that it will reference the correct point on the chart for a given latitude and longitude. Although WGS-84 is now the world standard, other categories of charts still exist. Refer to Appendix for a full list of geodetic datum.	See Appendix for full list.

*(Con't on next page)*

*Contents of GPS setup menu (con't from previous page)*

<b>Item</b>	<b>Description</b>	<b>Settings</b>
Position Smoothing	When the DOP or receiving condition is unfavorable, the GPS fix may change greatly, even if the vessel is not moving. This change can be reduced by smoothing the raw GPS fixes. A setting between 000 to 999 is available. The higher the setting the more smoothed the raw data. If the setting is too high, the response time required to show a change of latitude and longitude will be too long. This is especially noticeable if the vessel is moving fast. Increase the setting if the GPS fix changes randomly.	0-999 seconds
Spd/Cse Smoothing	During position fixing, ship's velocity (speed and course) is directly measured by receiving GPS satellite signals. The raw velocity data may vary too much depending on receiving conditions and other factors. You can reduce this random variance by increasing the smoothing. The higher the smoothing setting, the more the raw data will be averaged. If this setting is high, the response to speed and course changes will slow. For no smoothing, enter all zeroes.	0-999 seconds
GPS Speed Averaging	Calculation of ETA is based on average ship's speed over a given period. If the period is too long or too short, calculation error will result. Change this setting if calculation error occurs. The default setting is suitable for most conditions.	0-999 seconds
Latitude, Longitude Offset	Offsets latitude position to further refine position accuracy.	0.001'S – 9.999'N 0.001'E – 9.999'W

*(Con't on next page)*

## 5. CUSTOMIZING YOUR UNIT

### Contents of GPS setup menu (con't from previous page)

<b>Item</b>	<b>Description</b>	<b>Settings</b>
Disable Satellite	Every GPS satellite is broadcasting abnormal satellite number(s) in its Almanac, which contains general orbital data about all GPS satellites, including those which are malfunctioning. Using this information, the GPS receiver automatically eliminates any malfunctioning satellite from the GPS satellite schedule. However, the Almanac sometimes may not contain this information. If you hear about a malfunctioning satellite from another source, you can disable it manually. Enter satellite number (two digits, max. 3 satellites), then press the ENTER soft key.	Max. 3 satellites
Latitude	Sets initial latitude position after cold start. Use the N < - -> S soft key to switch coordinate.	—
Longitude	Sets initial longitude position after cold start. Use the W < - -> E soft key to switch coordinate.	—
Antenna Height	Enters the height of the GPS antenna unit above sea surface. For further details refer to the installation manual.	0-99 m
GPS Fix Mode	Chooses position fixing method: 2D (three satellites in view), 2D/3D (three or four satellites in view whichever is greater).	2D, 2D/3D
Cold Start	Clears the Almanac to receive the latest Almanac.	No, Yes
GPS STATUS (soft key)	Displays GPS satellite status display. Requires GPS Receiver GP-310B/320B or GPS navigator outputting the data sentence GSA or GSV. For further details see the chapter on Maintenance.	

**WAAS SETUP**

Press the WAAS SETUP soft key to show the WAAS SETUP display.

**Note:** This function requires GP-320B antenna. Also, confirm that your display unit has the program version no. shown below.

NavChart type: Ver. 12 and after

C-map type: Ver.8 and after

Contents of WAAS SETUP menu

Item	Description	Settings
WAAS MODE	Select ON to use the WAAS mode.	On, Off
WAAS SEARCH	WAAS satellite can be searched automatically or manually. For manual search, enter appropriate WAASsatellite number.	Auto, Manual
WAAS ALARM	When the WAAS signal is lost, the audible alarm sounds with the visual message "NO WAAS SIGNAL."  <b>On:</b> Alarm continues to sound until the WAAS positioning mode is available again or the alarm is recognized by key operation. <b>Off:</b> Alarm sounds three times.	On, Off
CORRECTION DATA SET	Selects the type of message for WAAS correction. Use "02 (default setting)" until the system becomes operational.	00 to 27, 99

### 5.7.3 TD display setup

The TD SETUP menu sets which Loran C or Decca chain to use to display TD position. (Connection of a Loran C or Decca navigator is not necessary to display TD position.)

1. Press the [MENU] key.
2. Press the SYSTEM CONFIGURATION, NAV OPTION and TD SETUP soft keys to display the TD SETUP menu.

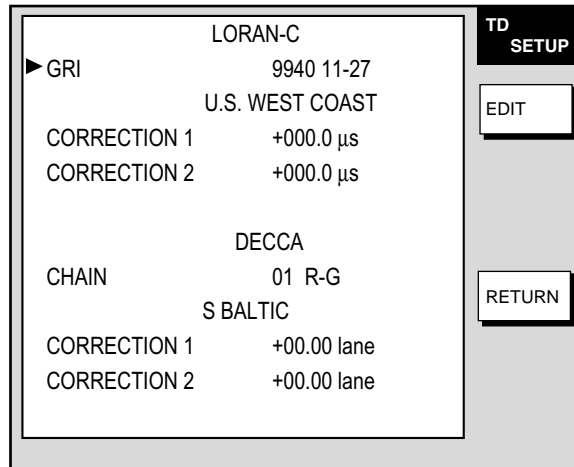

*TD setup menu*

#### Displaying Loran C TDs

1. Select GRI, then press the EDIT soft key to show the GRI & station pair window.

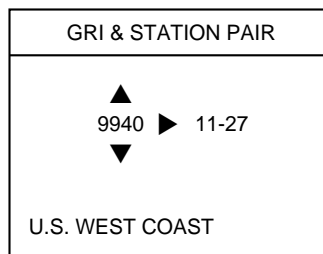

*Loran GRI & station pair window*

2. Adjust the trackball upward or downward to select GRI code.
3. Roll the trackball rightward to show the display below, to enable selection of station pair.

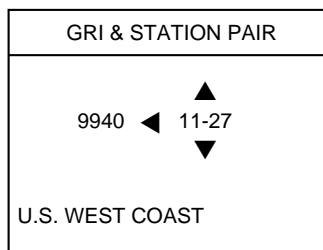

*Loran C GRI & station pair window*

4. Adjust the trackball vertically to select station pair.
5. Press the ENTER soft key to register your selection.



6. If necessary, you may enter a position offset to refine Loran C position accuracy. Select (GRI) CORRECTION 1 or CORRECTION 2, then press the EDIT soft key. Enter correction value with the trackball and alphanumeric keys. Use the + <--> - soft key to switch from plus to minus and vice versa. Press the ENTER soft key or push the [ENTER] knob.
7. Press the RETURN soft key twice.
8. Press the GENERAL SETUP soft key followed by the NEXT PAGE soft key.
9. Select "LORAN C" from "TD DISPLAY" and "TD" from "POSITION DISPLAY."
10. Press the [MENU] key twice to close the menu.

### **Displaying DECCA TDs**

1. Select CHAIN, then press the EDIT soft key to show the chain & station pair window.

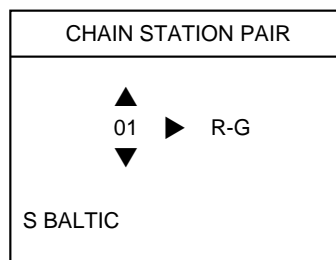

*Decca chain and station pair window*

2. Adjust the trackball upward or downward to select Decca chain number.
3. Roll the trackball rightward to show the display below, to enable selection of station pair.

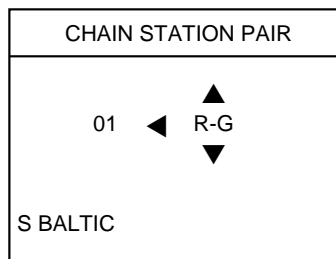

*Decca chain and station pair window*

4. Adjust the trackball upward or downward to select station pair (R: red, G: green and P: purple).
5. Press the ENTER soft key to register your selection.
6. If necessary, you may enter position offset to refine Decca position. Select (CHAIN) CORRECTION 1 or CORRECTION 2, then press the EDIT soft key. Enter correction value with the trackball and alphanumeric keys. Use the + <--> - soft key to switch from plus to minus and vice versa. Press the ENTER soft key or push the [ENTER] knob.
7. Press the RETURN soft key twice.
8. Press the GENERAL SETUP soft key followed by the NEXT PAGE soft key.
9. Select "DECCA" from "TD DISPLAY" and "TD" from "POSITION DISPLAY."
10. Press the [MENU] key twice to close the menu.

## 5.8 Nav Data Display Setup

The nav data display shows various navigation data, fed from a navigator, network equipment, etc. You may select the data to display and where to display it as follows:

1. Press the [MENU] key to open the main menu.
2. Press the SYSTEM CONFIGURATION, SYSTEM SETUP, HOT PAGE & NAV DISP SETUP and NAV DATA DISPLAY SETUP soft keys.

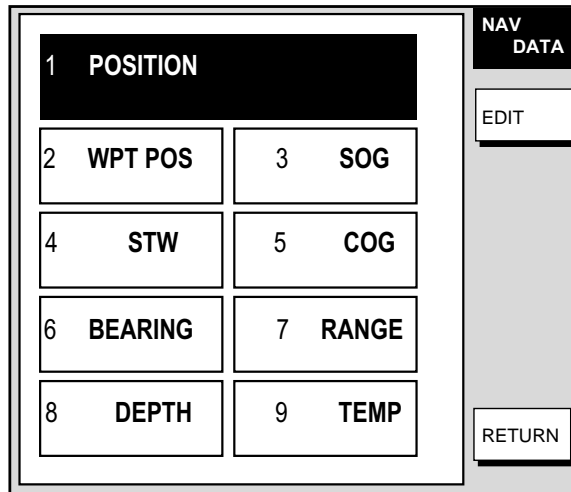

*Nav data setup screen*

3. Use the trackball to select a location.
4. Press the EDIT soft key. The following display appears.

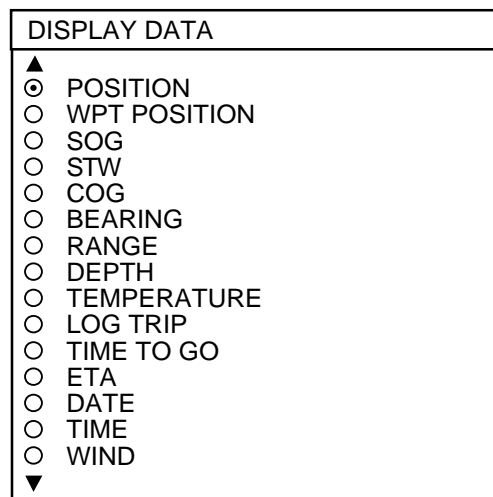

*Nav data setup window*

5. Select the data to display, then press the ENTER soft key or [ENTER] knob to register your selection.
6. Press the RETURN soft key followed by the [MENU] key to close the menu.

## 5.9 Sounder Setup

This section shows you how to customize your network sounder to your liking. You can set fish alarm sensitivity, fine tune sensors, etc.

### 5.9.1 System setup

1. Show the sounder display, then press the [MENU] key.
2. Press the SOUNDER SYSTEM SETUP soft key.

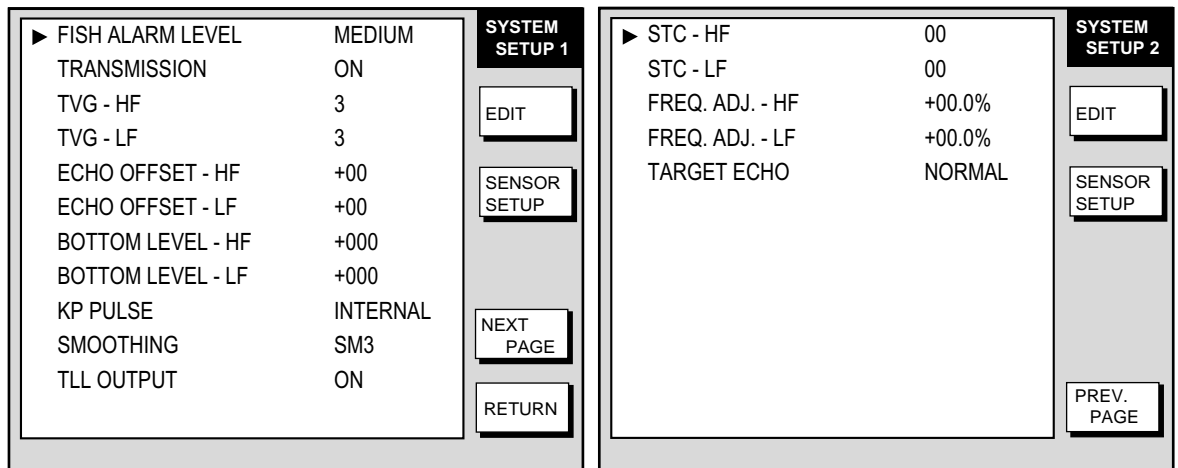

Page 1

Page 2

*Sounder system setup menu*

*Sounder system setup menu description*

Item	Description	Settings
Fish Alarm Level	Sets the fish alarm sensitivity; that is, the minimum echo strength which will trigger the fish alarms.	<b>High:</b> Orange and stronger echoes trigger the alarm.* <b>Medium:</b> Yellow and stronger echoes trigger the alarm.* <b>Low:</b> Green and stronger echoes trigger the alarm.*  * = 8-color display
Transmission	Turns TX power on/off.	On, Off
TVG (HF,LF)	TVG (Time Varied Gain) compensates for propagation attenuation of the ultrasonic waves. It does this by equalizing echo presentation so that fish schools of the same size appear in the same density in both shallow and deep waters. In addition, it reduces surface noise. Note that if the TVG level is set too high short range echoes may not be displayed.	0-9

(Continued on next page)

## 5. CUSTOMIZING YOUR UNIT

### Sounder system setup menu description (con't from previous page)

<b>Item</b>	<b>Description</b>	<b>Settings</b>
Echo Offset (HF, LF)	If the on-screen echo level appears to be too weak or too strong and the level cannot be adjusted satisfactorily with the gain control, adjust echo offset to compensate for too weak or too strong echoes.	-50 - +50
Bottom Level (HF, LF)	If the depth indication is unstable in automatic operation or the bottom echo cannot be displayed in reddish-brown by adjusting the gain control in manual operation, you may adjust the bottom echo level detection circuit, for both HF and LF, to stabilize the indication. Note that if the level is set too low weak echoes may be missed and if set too high the depth indication will not be displayed.	-100 - +100
KP Pulse	Selects source of keying pulse.	Internal, External (See installation manual.)
Smoothing	Smooths echoes to present stable display. The higher the setting the greater the smoothing.	SM1-SM4, OFF
TLL Output	Outputs current position to plotter where it is marked with TLL mark. Use soft key to output TLL.	ON, OFF
STC (HF, LF) (For ETR-30N only)	Adjusts STC level for the high and low frequencies, and is useful for suppressing surface noise. The setting range is 0-10; the higher the setting the greater the extent of suppression. Setting 10 suppresses noise up to several meters. Turn off the STC when there is no noise on the screen, otherwise weak echoes may be missed.	0-10
FREQ. ADJ. (HF, LF) (For ETR-30N only)	Interference from other acoustic equipment operating nearby or other electronic equipment on your boat may show itself on the display. You may suppress these type of interference by adjusting frequency.	-10 - +10 %
TARGET ECHO (For ETR-30N only)	Sets fishing objective. Normal for general fishing, Surface for detecting surface. Pulse repetition rate is higher than NORMAL on the specified transducer.	Normal, Surface
SENSOR SETUP soft key (See next page.)	Offsets speed, depth and water temperature indications and speed of sound.	See next section for details.

## 5.9.2 Sensor setup

The SENSOR SETUP menu lets you further refine speed, water temperature and depth data fed from the network sounder.

1. Show the sounder display, then press the [MENU] key.
2. Press the SOUNDER SYSTEM SETUP and SENSOR SETUP soft keys to show the SENSOR SETUP menu. The current ship's speed, water temperature, depth and speed of sound are shown at the bottom of the menu.

		SENSOR SETUP
▶ SPEED CALIBRATION + 00%		EDIT
TEMP. CALIBRATION + 00°F		
DEPTH CALIBRATION +00ft		
ACSTC SPD CALIBRATION + 000m/s		
SPEED 12.3kt	TEMP 78.8°F	RETURN
DEPTH 125.0ft	ACSTC SPD 1500m/s	

*Sensor setup menu*

3. Select item to adjust, then press the EDIT soft key.
4. Adjust the trackball upward or downward to set appropriate value.

**Speed and temperature calibrations:** Enter plus or minus value. For example, if the water temperature readout is 77°F but the actual water temperature is 75°F, enter -2(°F).

**Depth calibration:** If you desire the depth readout to show the distance between ship's draft and bottom (rather than transducer and bottom), set ship's draft here. Enter a plus or minus value.

**Acoustic speed calibration:** Sets the speed of sound used by the network sounder. Normally no adjustment is required, however if echoes are returning too slow or too fast adjust the value as appropriate. This is only used if water salinity is at an extreme level. Under normal circumstances, do not adjust.

*Sensor setup menu settings*

Item	Settings	Default Setting
Speed Calibration	-50 +50%	0 (no offset)
Temperature Calibration	-40°F – +40°F	0 (no offset)
Depth Calibration	-15 - +90 ft	0 (no offset)
Acoustic Speed Calibration	-500 - +500 m/s	0 (no offset)

5. Press the RETURN soft key followed by the [MENU] key.

### 5.9.3 Sounding range, zoom range, bottom lock range

This paragraph shows you how to set custom ranges for basic range, zoom range (marker and bottom zoom) and bottom lock range. All default basic ranges are restored whenever the unit of depth measurement is changed. Therefore, change the depth unit before changing the basic ranges.

1. Show the sounder display, then press the [MENU] key to open the main menu.
2. Press the SOUNDER RANGE SETUP soft key to show the SOUNDER RANGE SETUP menu.

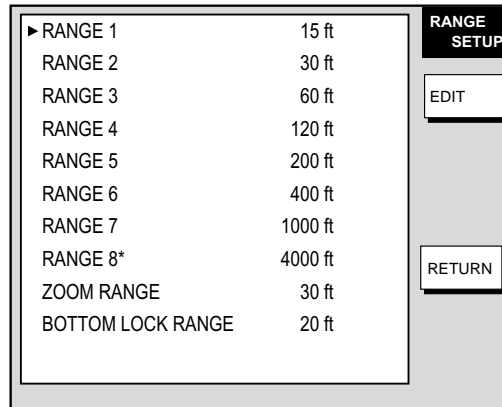

\*2000 ft on using ETR-6/10N

#### *Sounder range setup menu*

3. Select the range to change, then press the EDIT soft key.
4. Rotate the trackball or [ENTER] knob to set range desired, then press the RETURN soft key. For basic range, set depth from lowest to highest; a range cannot be higher than its succeeding neighbor.
5. Press the [MENU] key to finish.

#### Default basic ranges

Range 1	Range 2	Range 3	Range 4	Range 5	Range 6	Range 7	Range 8	
							ETR-6/10N	ETR-30N
5 m	10 m	20 m	40 m	80 m	150 m	300 m	1200 m	1500 m
15 ft	30 ft	60 ft	120 ft	200 ft	400 ft	1000 ft	4000 ft	4500 m
3 fa	5 fa	10 fa	20 fa	40 fa	80 fa	150 fa	650 fa	900 fa
3 P/B	5 P/B	10 P/B	30 P/B	50 P/B	100 P/B	200 P/B	700 P/B	900 P/B

**Setting range:** 2 m –1200 m, 7 ft – 4000 ft, 2 fa – 650 fa, 1 P/B – 1000 P/B

#### Zoom range and bottom-lock ranges

Item	Settings	Default Setting
Zoom Range	2 m – 120 m, 7 ft – 400 ft, 1 fa – 60 fa, 1 P/B – 70 P/B	10 m, 30 ft, 10 fa, 10 P/B
Bottom-lock Range	3 or 6 m, 10 or 20 ft, 2 or 3 fa, 2 or 3 P/B	6 m, 20 ft, 3 fa, 3 P/B

### 5.9.4 Function key setup

The function keys provide one-touch execution of a desired function. The default sounder function key settings are as shown in the table below.

Function Key	Default Function	Function Key Label
1	Output current position.	TLL
2	Suppress clutter.	CLT
3	Erase weak signal.	SLV
4	Suppress noise.	NL
5	Set picture advancement speed.	PA

If the above settings are not to your liking you may change them as follows:

1. Show the sounder display.
2. Press the [MENU] key.
3. Press the FUNCTION KEY SETUP soft key.

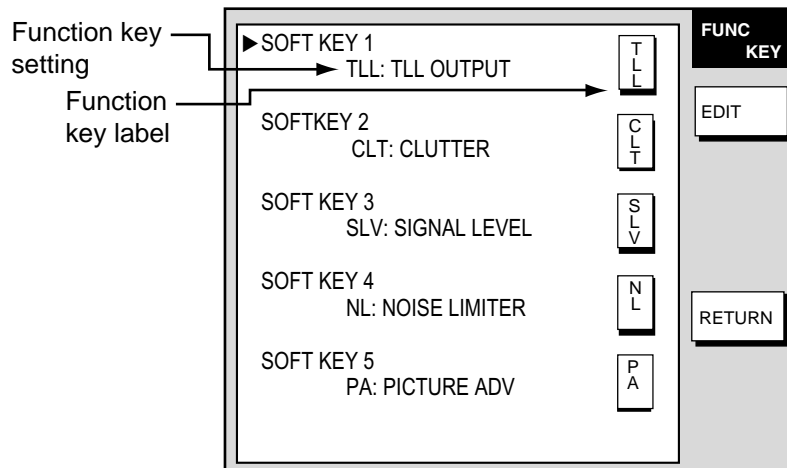

*Sounder function key menu*

4. Select the function key you want to program, then press the EDIT soft key.

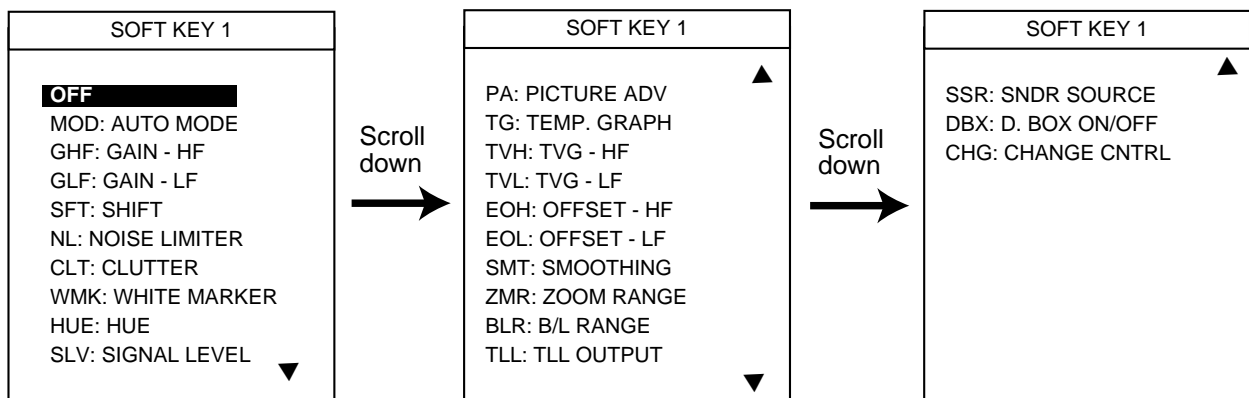

*Sounder function key options*

## 5. CUSTOMIZING YOUR UNIT

5. Select function desired with the trackball, then press the ENTER soft key or [ENTER] knob to register your selection.
6. Press the [MENU] key to close the menu.

### Sounder function keys

Menu Item	Function	Function Key Label
OFF	Assigns no function.	
MOD: AUTO MODE	Display automatic mode selection window.	MOD
GHF: GAIN – HF	Displays high frequency gain adjustment window.	GHF
GLF: GAIN – LF	Displays low frequency gain adjustment window.	GLF
SFT: SHIFT	Shifts range in manual operation.	SFT
NL: NOISE LIMITER	Suppresses noise.	NL
CLT: CLUTTER	Suppresses clutter.	CLT
WMK: WHITE MARKER	Sets white marker.	WMK
HUE: HUE	Sets hue.	HUE
SLV: SIGNAL LEVEL	Erases weak signals.	SLV
PA: PICTURE ADV	Sets picture advance speed.	PA
TG: TEMP. GRAPH	Turns temperature graph on/off.	TG
TVH: TVG – HF	Sets TVG for high frequency	TVH
TVL: TVG – LF	Sets TVG for low frequency.	TVL
EOH: OFFSET – HF	Offsets echo strength for high frequency.	EOH
EOL: OFFSET -LF	Offsets echo strength for low frequency.	EOL
SMT: SMOOTHING	Sets echo smoothing rate.	SMZ
ZMR: ZOOM RANGE	Sets zoom range.	ZMR
BLR: B/L RANGE	Sets bottom lock range for bottom-lock display.	BLR
TLL: TLL OUTPUT	Outputs current position to plotter. Also inscribes line on sounder and registers position as a waypoint on plotter.	TLL
SSR: SNDR SOURCE	Selects source for sounder data.	SSR
DBX: D. BOX ON/OFF	Turns data boxes on/off.	DBX
CHG: CHANGE CNTRL	Switches control in combination display.	CHG

**Note:** To use CHANGE CNTRL set it on all displays, with the same soft key number.



# 6. DATA TRANSFER

This chapter provides information for saving and replaying data to and from memory cards, uploading and downloading data, loading waypoint data from Yeoman, and outputting data through the network.

## 6.1 Memory Card Operations

The memory cards store these data: marks, lines, waypoints, routes, track, and setting data (plotter only).

### 6.1.1 Formatting memory cards

Before you can use a memory card it must be formatted. This prepares the card for use with the system. Note that formatting a memory card erases all data from the card.

1. Insert a blank memory card into the card slot.
2. Press the [MENU] key followed by the SYSTEM CONFIGURATION, DATA TRANSFER, UPLOAD/DOWNLOAD DATA and SAVE DATA TO MEMORY CARD soft keys to show the SAVE DATA menu.

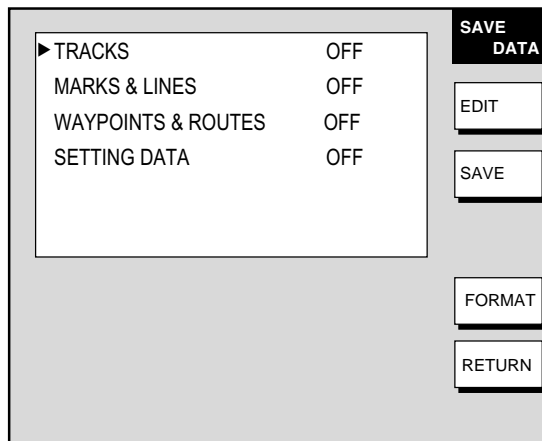

*Save data menu*

3. Press the FORMAT soft key. You are asked if you are ready to format the memory card.
4. Push the [ENTER] knob to format (or press the [CLEAR] key to escape). "NOW FORMATTING MEMORY CARD" appears. Do not remove the card while it is being formatting. When the formatting is completed, "FORMAT COMPLETED. PUSH ENTER KNOB TO CONTINUE." appears.
5. Push the [ENTER] knob to continue.

**Note:** If the memory card was not inserted correctly, the message "FAILED TO FORMAT MEMORY CARD." appears.

### 6.1.2 Saving data to a memory card

1. Insert a formatted memory card into the slot.
2. Press the [MENU] key followed by the CONFIGURATION, DATA TRANSFER, UPLOAD/DOWNLOAD DATA and SAVE DATA TO MEMORY CARD soft keys to show the SAVE DATA menu.

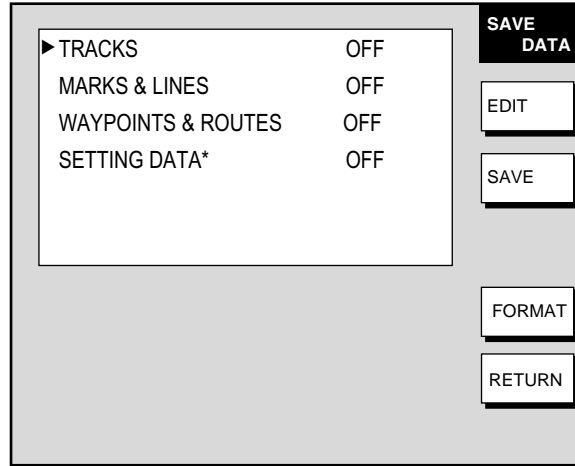

\* = Plotter data only

*Save data menu*

3. Use the trackball to select item to save.
4. Press the EDIT soft key.
5. Use the trackball to select ON.
6. Press the ENTER soft key.
7. Repeat steps 3 to 6 to choose other data to save if desired.
8. Press the SAVE soft key, then press the [ENTER] knob. The message "NOW SAVING DATA TO MEMORY CARD. DO NOT TURN OFF DISPLAY UNIT UNTIL COMPLETED." appears.

When saving is completed, "COMPLETED SAVING DATA. PUSH ENTER KNOB TO CONTINUE." appears. Push the [ENTER] knob to continue.

**Memory card messages**

Various memory card messages appear to alert you to memory card-related error. These are tabulated below.

*Memory card messages*

<b>Message</b>	<b>Reason</b>	<b>Remedy</b>
Memory card is not inserted. Please insert memory card. Push ENTER knob to continue.	Memory card not inserted.	Push the [ENTER] knob to return to the SAVE DATA display and then insert card.
Memory card is not formatted. Push ENTER knob to continue.	Unformatted memory card.	Push the [ENTER] knob to return to the SAVE DATA display. Format the card referring to page 6-1.
Wrong card is inserted. Please insert correct memory card. Push ENTER knob to continue.	Chart card inserted instead of memory card.	Remove chart card, insert memory card, and then push the [ENTER] knob to continue.
Overwrite data? (Track) (Mark) (WPT) (Config)	Data type to be recorded exists on memory card. (Two or more of same type of data cannot be recorded.)	Push the [ENTER] knob to overwrite same data type on the card, or press the [CLEAR] key to escape.

### 6.1.3 Playing back data from a memory card

Data (track, marks, lines, waypoints, routes and setting data) can be loaded from a memory card and displayed on the screen. This feature is useful for observing past data and setting up the equipment for a specific purpose with “setting data.”

1. Press the [MENU] key followed by the SYSTEM CONFIGURATION and DATA TRANSFER soft keys.
2. Press the UPLOAD/DOWNLOAD DATA soft key.
3. Press the LOAD DATA IN MEMORY CARD soft key to show the LOAD DATA menu.

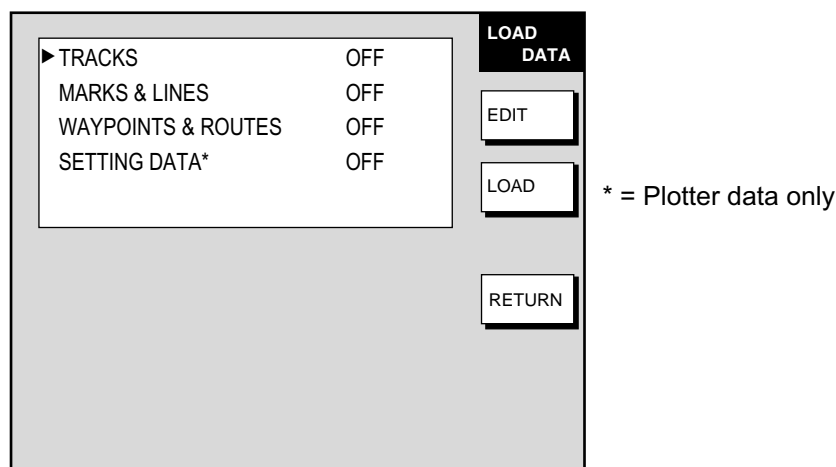

*Load data menu*

4. Use the trackball to select item to load.
5. Press the EDIT soft key. (The EDIT soft key is inoperative when no memory card is inserted or there is no data in the memory card.)
6. Use the trackball to select ON. (Select OFF to not load selected data.) Press the ENTER soft key. If the memory card does not contain the item selected, the unit beeps and ON cannot be selected.
7. After selecting all items desired, press the LOAD soft key, then press the [ENTER] knob. The message “START LOADING FROM MEMORY CARD.” appears.
8. After loading is completed, the message “COMPLETED LOADING DATA. PUSH ENTER KNOB TO CONTINUE.” appears. Push the [ENTER] knob to continue.

#### **Notes on loading data**

**Tracks:** Since loaded track data is added to internal track, oldest track will be erased when the track memory capacity is exceeded.

**Waypoints & routes:** The loaded data replaces like stored data.

**Marks & lines:** The loaded data is added to internal data. When the mark/line memory becomes full no marks may be entered.

**Setting data:** The loaded data replaces current configuration settings. If the memory card contents could not be loaded, push the [ENTER] knob to restart with default settings. Note that track memory capacity is not saved or loaded. To use loaded setting data, turn the power off and on again.

## 6.2 Uploading, Downloading Data

You can upload/download waypoints, routes, marks and lines from/to a PC, through the DATA 4 port at the rear of the display unit. Note that radar and sounder data cannot be uploaded or downloaded.

### 6.2.1 Setting communication software on the PC

The communication format (RS-232C) with the PC is as follows:

Baud Rate: 4800 bps  
 Character Length: 8 bits  
 Stop bit: 1 bit  
 Parity: None  
 X Control: XON/XOFF (fixed)

The following data can be downloaded/uploaded between a PC and this equipment:

- Waypoint data (In alphanumeric order)
- Route data (In order of route number)
- End of sentence

**Note 1:** There are two kinds of data for route data: route data and route comment data.

**Note 2:** DGPS position fix is not available when uploading or downloading data.

**Note 3:** Wiring information appears on the UPLOAD or DOWNLOAD menu.

### 6.2.2 Uploading or downloading data

1. Connect the PC to the equipment.
2. Press the [MENU] key to show the main menu.
3. Press the SYSTEM CONFIGURATION soft key.
4. Press the DATA TRANSFER soft key.
5. Press the UPLOAD/DOWNLOAD DATA soft key.
6. Press the DOWNLOAD WPT/ROUTE TO PC or UPLOAD WPT/ROUTE FROM PC soft key.

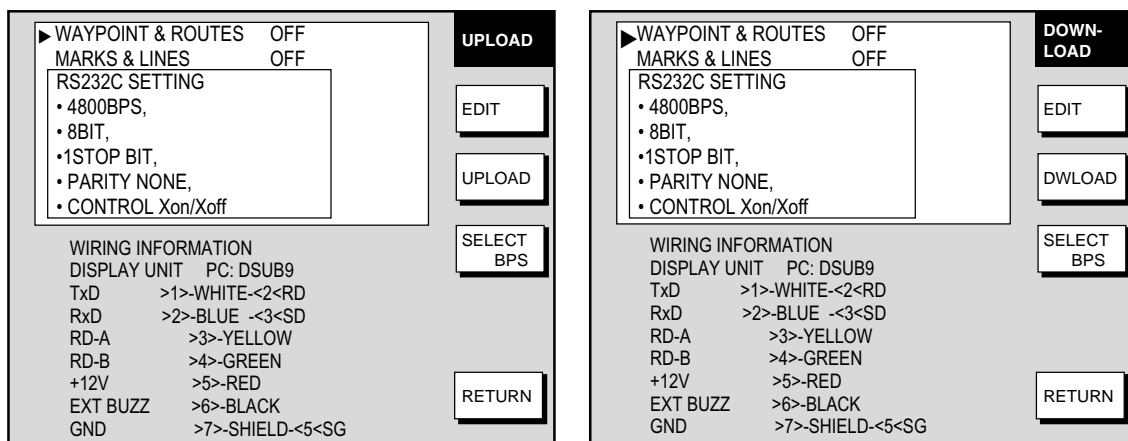

*Upload and download menus*

6. DATA TRANSFER

7. To change the baud rate, press the SELECT BPS soft key.

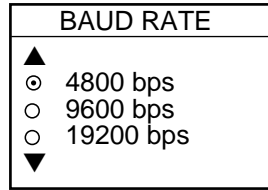

*Baud rate window*

- 8. Select baud rate, then press the ENTER soft key.
- 9. Press the DWLOAD or UPLOAD soft key. You are asked if you are ready to download or upload waypoints and routes.
- 10. Push the [ENTER] knob to download (upload).

**Waypoint data format**

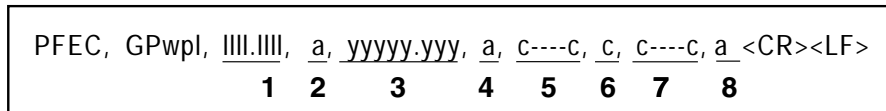

*Waypoint data format*

- 1: Waypoint latitude
- 2: N/S
- 3: Waypoint longitude
- 4: E/W
- 5: Waypoint name (Number of characters is fixed to 6 and space code is placed when the number of characters are less than 6.)
- 6: Waypoint color
- 7: Waypoint comment (1 byte for mark code + 13 characters of comment.)  
 1st byte of mark code: Fixed to “@”.  
 2nd byte of mark code: Internal mark code. See Note 1.
- 8. Information of marking waypoint. Always set to “A”.  
 “A”: Displayed  
 “V”: Not displayed

**Note 1:** The following characters can be used for comments:

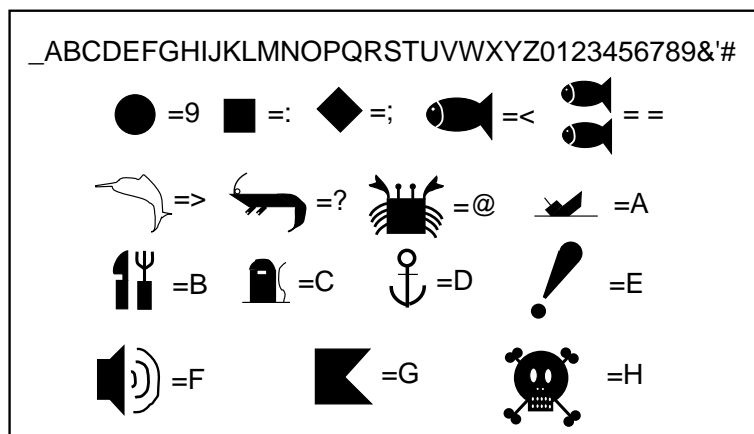

*Characters available for comment*

**Route data menu**

\$GPRTE, <u>x</u> , <u>x</u> , <u>a</u> , <u>ccc</u> , <u>c----c</u> , <u>c----c</u> , ... , <u>c----c</u> <CR><LF>
<div style="display: flex; justify-content: space-around; width: 100%;"> <span>1</span> <span>2</span> <span>3</span> <span>4</span> <span>5</span> <span>6</span> <span>12</span> </div>

*Route data format*

- 1: Number of sentences required for one complete route data (1 to 4). See Note 2.
- 2: Number of sentences currently used (1 to 4)
- 3: Message mode (Always set to C)
- 4: Route No. (001 to 300, 3 digits required)
- 5 through 12: Waypoint name (Max. 8 names, length of each waypoint name is fixed to 7 byte)

**Note 2:** A route can may contain 35 waypoints, and the GPRTE sentence for one route data may exceed 80 byte limitation. In this case, route data is divided into several GPRTE sentences (Max. 4 sentences). This value shows the number of sentences the route data has been divided.

**Route comment data format**

\$PFEC, GPrtc, <u>xx</u> , <u>c----c</u> <CR><LF>
<div style="display: flex; justify-content: space-around; width: 100%;"> <span>1</span> <span>2</span> </div>

*Route comment format*

- 1: Route No. (01 to 200, 3 digits required)
- 2: Route comment (Max. 16 characters, variable length)

The same characters of the comment for waypoint comment can be used.

**End of sentence**

\$PFEC, GPxfr, CTL, E <CR><LF>
--------------------------------

*End of sentence*

## 6.3 Loading Waypoint Data from Yeoman

Waypoint data can be loaded from a Yeoman to this equipment. Connect the Yeoman to a DATA port on this equipment and then follow the procedure below.

1. Press the [MENU] key.
2. Press the SYSTEM CONFIGURATION key.
3. Press the DATA TRANSFER soft key.
4. Press the RECEIVE YEOMAN DATA soft key.
5. You are asked if you are sure to receive waypoint data from Yeoman equipment. Push the [ENTER] knob to receive the data.

The message "NOW RECEIVING YEOMAN DATA. PUSH SOFT KEY 'STOP' TO STOP RECEIVING." Is displayed. If waypoint capacity is reached the message "WAYPOINTS FULL. NO MORE WAYPOINT CAN BE RECEIVED. PUSH ANY KEY TO STOP." appears.

6. To stop receiving, press the STOP soft key.
7. After waypoints have been received, press the [MENU] key.



## 6.4 Receiving Data Via Network Equipment

You can receive waypoints, routes, marks and lines from NavNet equipment.

1. Press the [MENU] key.
2. Press the SYSTEM CONFIGURATION soft key.
3. Press the DATA TRANSFER soft key.
4. Press the RECEIVE DATA VIA NETWORK soft key.

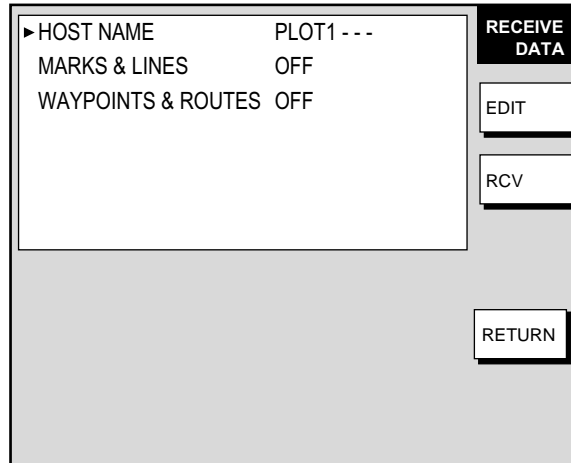

*Receive data menu*

5. Select HOST NAME, then press the EDIT soft key.

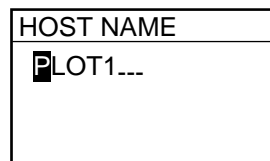

*Host name window*

6. Use the trackball and the alphanumeric keys to input host name from which to receive data, then push the [ENTER] knob.
7. Select the data you wish to receive, then press the EDIT soft key. For example, select MARKS & LINES.

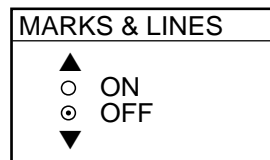

*Marks & lines window*

8. Select ON or OFF as appropriate, then press the ENTER soft key.
9. Turn WAYPOINTS & ROUTES on or off as appropriate.

10. Press the RCV soft key followed by the [ENTER] knob.

The message "START RECEIVING DATA VIA NETWORK." is displayed. If no data could be found, the message "(HOST NAME)' IS NOT FOUND." appears.

11. When the transfer is completed, the message "DATA TRANSFER COMPLETED. PUSH ENTER KNOB TO CONTINUE." appears. Push the [ENTER] knob to finish.
12. Press the [MENU] key to close the menu.

## 6.5 Outputting Data Through the Network

Follow the procedure below to output data through the network.

1. Press the [MENU] key to open the menu.
2. Press the SYSTEM CONFIGURATION, SYSTEM SETUP, PORT SETUP and OUTPUT THROUGH NETWORK soft keys.

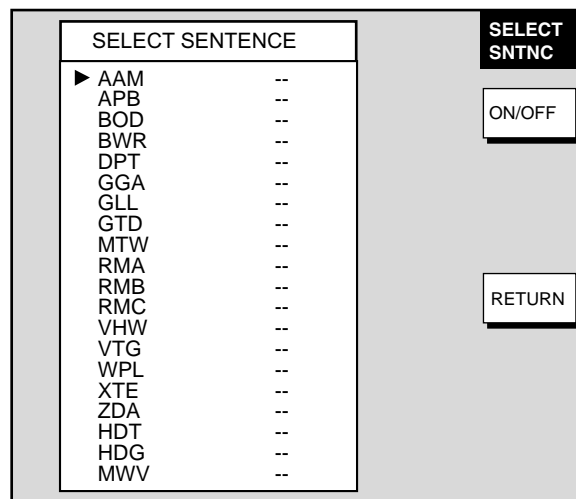

*Select sentence menu*

3. Select sentence with the trackball.
4. Press the ON/OFF soft key to turn sentence on or off.
5. Press the RETURN soft key.
6. Press the [MENU] key to close the menu.

AAM: Waypoint arrival alarm, APB: Autopilot sentence B, BOD: Bearing origin to destination, BWR: Bearing and distance to waypoint - rhumb line, DPT: Depth, GGA: Global positioning system(GPS) fix data, GLL: Geographic position - latitude/longitude, GTD: Own ship information-TD, MTW: Water temperature, RMA: Recommended minimum specific LORAN-C data, RMB: Recommended minimum navigation information, RMC: Recommended minimum specific GPS/TRANSIT data, VHW: Water speed and heading, VTG: Course over ground and ground speed, WPL: Waypoint location, XTE: Cross-track error, measured, ZDA: Time and date, HDT: Heading true, HDG: Heading, deviation and variation, MWV: Wind speed and angle

# 7. MAINTENANCE, TROUBLESHOOTING

This chapter provides information necessary for keeping your unit in good working order and remedying simple problems.

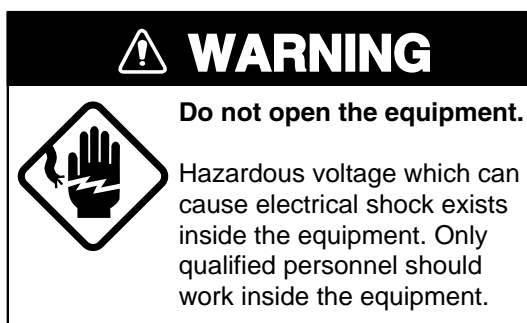

## 7.1 Preventive Maintenance

Regular maintenance is important for optimum performance. A maintenance program should be established and should at least include the items shown in the table below.

### *Maintenance program*

Item	Check point	Remedy
Display unit connectors	Check for tight connection.	Tighten loosened connectors.
LCD	The LCD will, in time, accumulate a coating of dust which tends to dim the picture. Wipe LCD lightly with soft cloth to remove dust.	Wipe the LCD carefully to prevent scratching, using tissue paper and an LCD cleaner. To remove dirt or salt deposits, use an LCD cleaner, wiping slowly with tissue paper so as to dissolve the dirt or salt. Change paper frequently so the salt or dirt will not scratch the LCD. Do not use solvents such as thinner, acetone or benzene for cleaning.
Ground terminal	Check for tight connection and corrosion.	Clean or replace ground wire as necessary.

## 7.2 Replacement of Battery

A lithium battery (Type CR2450-F2 ST2L, Code No. 000-144-941) fitted on a circuit board inside the display unit preserves data when the equipment is turned off, and its life is about three years. When its voltage is low the battery icon (🔋) appears at the top of the display. When the icon appears, contact your dealer to request replacement of the battery.

## 7.3 Replacement of Fuse

The fuse on the power cable protects the equipment from reverse polarity of the ship's mains and equipment fault. If the fuse blows, find out the cause before replacing it. Use the correct fuse. Using the wrong fuse will damage the equipment and void the warranty.

1823C, 1833C, 1933C, 1943C: 15A for 12V device, 7A for 24V device

1953C, GD-1900C: 7A for 12/24 V device

Power supply unit PSU-005 (1953C): 15A for 12V device, 7A for 24V device



## 7.4 Trackball Maintenance

If the cursor skips or moves abnormally, you may need to clean the trackball.

1. Turn the retainer ring counterclockwise 45° to unlock it.

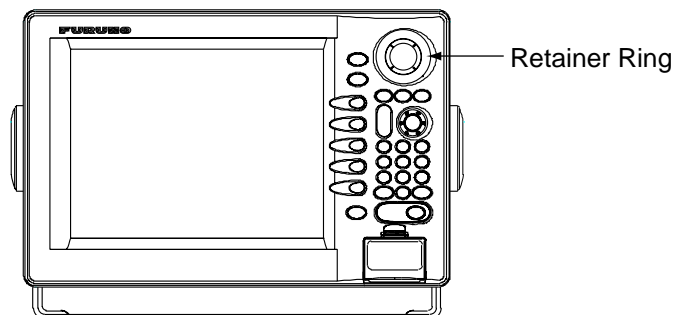

*Display unit*

2. Remove the retainer ring and ball.
3. Clean the ball with a soft lint-free cloth, and then blow carefully into the ball-cage to dislodge dust and lint.
4. Look for a build-up of dirt on the metal rollers. If dirty, clean the rollers using a cotton swab moistened lightly with isopropyl-rubbing alcohol.
5. Make sure that fluff from the swab is not left on the rollers.
6. Replace the ball and retainer ring. Be sure the retainer ring is not inserted reversely.

**Note:** Trackball maintenance parts are available as below.

Part	Type	Code No.
Retainer ring and ball	MU3721	000-144-645

## 7.5 Simple Troubleshooting

This section provides simple troubleshooting procedures which the user can follow to restore normal operation. If you cannot restore normal operation do not attempt to check inside the unit. Any trouble should be referred to a qualified technician.

### 7.5.1 General

#### General troubleshooting

If...	Then...
you cannot turn on the power	<ul style="list-style-type: none"> <li>• check for blown fuse.</li> <li>• check that the power connector is firmly fastened.</li> <li>• check for corrosion on the power cable connector.</li> <li>• check for damaged power cable.</li> <li>• check battery for proper voltage output (10.8 to 31.2 V).</li> </ul>
there is no response when a key is pressed	<ul style="list-style-type: none"> <li>• turn off and on the power. If there still is no response the key may be faulty. Request service.</li> </ul>

### 7.5.2 Radar

GD-1900C requires a network radar.

#### Radar troubleshooting

If...	But...	Then...
you pressed the [POWER/BRILL] key and the RADAR TX soft key to show the radar picture	nothing appears on the display	<ul style="list-style-type: none"> <li>• check that the antenna cable is firmly fastened.</li> <li>• check if radar source is correct.</li> </ul>
marks, legends appear	no echo appears	<ul style="list-style-type: none"> <li>• check Tx fuse in power cable. If it is blown, replace it.</li> </ul>
the picture is not updated or it freezes	—	<ul style="list-style-type: none"> <li>• check antenna cable.</li> <li>• for freeze up, turn the display unit on and off again.</li> </ul>
tuning is adjusted	sensitivity is poor	<ul style="list-style-type: none"> <li>• magnetron may need to be replaced. Contact your dealer.</li> </ul>
the range is changed	radar picture does not change	<ul style="list-style-type: none"> <li>• try to hit the [+] and [-] keys again.</li> <li>• turn the display unit off and on again.</li> </ul>
there is poor discrimination in range	—	<ul style="list-style-type: none"> <li>• adjust A/C SEA.</li> </ul>
the true motion presentation is not working properly	—	<ul style="list-style-type: none"> <li>• reselect true motion mode.</li> <li>• check if heading and speed are input.</li> </ul>
the range rings are not displayed	—	<ul style="list-style-type: none"> <li>• hit the RADAR DISPLY and RINGS soft keys to display them.</li> </ul>

**7.5.3 Plotter**

Requires GPS Receiver GP-310B.

*Plotter troubleshooting*

If...	Then...
position is not fixed within three minutes	<ul style="list-style-type: none"> <li>• check that antenna connector is firmly fastened.</li> <li>• check number of satellites received, on the GPS status display. (See page 7-11.) There should be three or more.</li> </ul>
position is wrong	<ul style="list-style-type: none"> <li>• check that the correct geodetic chart system is selected, on the GPS SENSOR SETTINGS menu.</li> <li>• enter position offset, on the GPS SENSOR SETTINGS menu.</li> </ul>
the track is not plotted	<ul style="list-style-type: none"> <li>• track is not being plotted. (“H” icon appears at the top of the display.) Press the TRACK HALT soft key on the TRACKS &amp; MARKS CONTROL menu to start plotting again.</li> </ul>
the bearing is wrong	<ul style="list-style-type: none"> <li>• check that correct magnetic variation is entered, on the GENERAL SETUP menu.</li> </ul>
Loran C (or Decca) TDs do not appear	<ul style="list-style-type: none"> <li>• check that LORAN C (or DECCA) is selected at TD DISPLAY on the GENERAL SETUP menu. Also, check that proper Loran C (Decca) chains codes are entered, on the TD SETUP menu.</li> </ul>
Loran C (or Decca) TDs are wrong	<ul style="list-style-type: none"> <li>• enter TD offset, on the TD SETUP menu.</li> </ul>
the ship’s speed indication is not zero after the ship is stopped	<ul style="list-style-type: none"> <li>• try to decrease speed/course smoothing, on the GPS SENSOR SETTINGS menu.</li> </ul>

## 7.5.4 Sounder

Requires Network Sounder ETR-6/10N/30N.

### Sounder troubleshooting

<b>If...</b>	<b>But...</b>	<b>Then...</b>
you selected a sounder display with the DISP key	picture does not appear	<ul style="list-style-type: none"> <li>• check that the network sounder's signal cable is firmly fastened.</li> <li>• Check that sounder source is correct.</li> <li>• check that the network sounder is plugged in. The LED on the network sounder should flash every second.</li> </ul>
marks and characters appear	picture does not appear	<ul style="list-style-type: none"> <li>• check for loosened transducer connector.</li> </ul>
the picture appears	zero line does not appear	<ul style="list-style-type: none"> <li>• the picture is shifted. Confirm shift setting.</li> </ul>
picture sensitivity is too low	—	<ul style="list-style-type: none"> <li>• check gain setting, if using manual operation.</li> <li>• marine life or air bubbles may be clinging to transducer face.</li> <li>• bottom may be too soft to return a suitable echo.</li> </ul>
the depth indication is not displayed	—	<ul style="list-style-type: none"> <li>• adjust gain and range to display the bottom echo (in reddish brown), if you are using the manual sounder mode.</li> </ul>
noise or interference shows on the display	—	<ul style="list-style-type: none"> <li>• check to be sure the transducer cable is not near ship's engine.</li> <li>• check the ground.</li> <li>• other video sounders of the same frequency as yours may be operating near you.</li> </ul>
the water temperature graph appears	data is wrong	<ul style="list-style-type: none"> <li>• check that sensor cable is tightly fastened.</li> </ul>

## 7.6 Diagnostics

This paragraph provides the procedures for testing the equipment for proper operation. Four tests are provided: Memory I/O test, Keyboard test, Remote controller test, and Test pattern.

### 7.6.1 Memory I/O test

The memory I/O test provides for individual testing of the display unit, GPS Receiver GP-310B/320B, Network Sounder ETR-6/10N, ETR-30N and ARP, displaying program number and checking for proper operation.

1. Press the [MENU] key to show the menu.
2. Press the SYSTEM CONFIGURATION soft key.
3. Press the SYSTEM SETUP soft key.
4. Press the TEST & CLEAR soft key.
5. Press the MEMORY I/O TEST soft key.

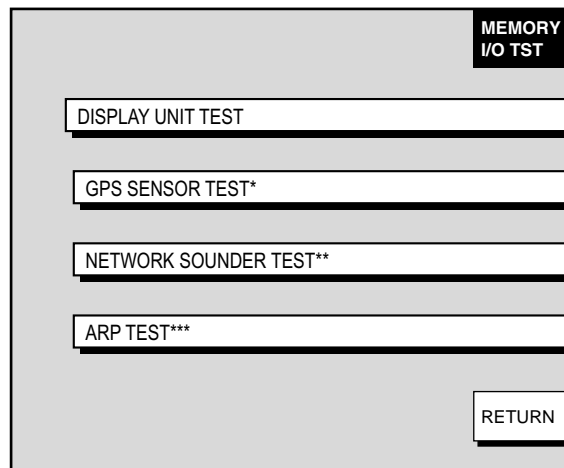

\* = Requires GPS Receiver GP-310B/320B.

\*\* = Requires Network Sounder ETR-6/10N or ETR-30N.

\*\*\* = Requires ARP-equipped Model  
1800/1900 series network radar.

*MEMORY I/O TEST menu*

6. Then, press appropriate soft key to start a diagnostic test.



**Display unit test**

Press the DISPLAY UNIT TEST soft key at the MEMORY I/O TEST menu to test the display unit. The equipment displays program version number and checks devices. Results for device checks are shown as OK or NG (No Good). For any NG, request service. A test connector is required to check ports. " - - " shown when no test connector is connected. Chart number shown when chart is inserted. Press the RETURN soft key to return the MEMORY I/O TEST menu.

\* = For FURUNO, NAVIONICS model. 19500010XX for C-MAP model.

No results appear when "sub" radar selected as radar source.

```

Program No. 19500020XX*
ROM1, 2      : OK
ROM3         : OK
ROM4         : OK
SDRAM        : OK
SRAM         : OK
INT. BATTERY : OK
PORT
NMEA IN/OUT 1 : --
NMEA IN/OUT 2 : --
NMEA IN       : --
RS232        : --
HEADING      : 352.2°
NETWORK      : --
CARD SLOT    :
CHART NUMBER:
HEADING PULSE : OK
BEARING PULSE : OK (XX.Xrpm)
TOTAL ON TIME : 000000.0 h
TOTAL TX TIME : 000000.0 h

Machine Status +130
    
```

XX = Program Version No.

Model 1800/1900 series

```

Program No. 19500020XX*
ROM1, 2      : OK
ROM3         : OK
ROM4         : OKS
SDRAM        : OK
SRAM         : OK
INTERNAL
BATTERY      : OK
PORT
NMEA IN/OUT 1 : --
NMEA IN/OUT 2 : --
NMEA IN       : --
RS232C       : --
HEADING      : 352.2°
NETWORK      : --
CHART NUMBER:

Machine Status +130
    
```

XX = Program Version No.

GD-1900C

*Display unit test results*

**GPS sensor test (Requires GPS Receiver GP-310B/320B)**

Press the GPS SENSOR TEST soft key at the MEMORY I/O TEST menu to test the GPS Receiver GP-310B/320B. The equipment displays GPS receiver program version number, and checks the GPS unit for proper operation, displaying OK or NG (No Good) as the result. For NG, request service. Press the RETURN soft key to return the MEMORY I/O TEST menu.

```

PROGRAM No. *48502180XX
GPS UNIT    : OK

Machine Status +115
    
```

\*: This is for GPS-310B,  
"48502380XX" appears for GPS-320B.

XX = Program Version No.

*GPS receiver test results*

**Network sounder test (Requires Network Sounder ETR-6/10N, ETR-30N)**

Press the NETWORK SOUNDER TEST soft key at the MEMORY I/O TEST menu to test the Network Sounder ETR-6/10N or ETR-30N. The equipment displays network sounder program version number, checks the ROM and RAM, and displays water temperature (appropriate sensor required) and depth. The results of the ROM and RAM check are shown as OK or NG (No Good). For any NG, request service. Press the RETURN soft key to return to the MEMORY I/O TEST menu.

PROGRAM No. 02523060XX ←
ROM 1, 2 : OK
RAM : OK
TEMPERATURE
: 77°F
DEPTH
: 4000ft
Machine Status +115

XX = Program Version No.  
 ETR-30N: 0252310XX.XX

*Network sounder test results*

**ARP test (Requires ARP pcb in Model 1800/1900 series network radar)**

The ARP test is mainly provided for the service technician. Press the ARP TEST soft key at the MEMORY I/O TEST menu to test the ARP. The results of the ROM and RAM check are shown as OK or NG (No Good). For any NG, request service. Press the RETURN soft key to return the MEMORY I/O TEST menu.

PROGRAM No. 18590271XX
ARP ROM : OK
ARP RAM : OK
SPEED : OK 12.3kt
COURSE : OK 359.9°
TRIGGER : OK
VIDEO : OK
BEARING PULSE : OK
HEADING PULSE : OK
MINIMUM HIT : 0003
SCAN-TIME : 0250
MANUAL ACQ : 00
AUTO ACQ : 00
FE-DATA1 : 000
FE-DATA2 : 000
Machine Status +115

XX = Program Version No.

*ARP test results*

## 7.6.2 Test pattern

The test pattern test checks the display for proper display of colors.

1. Press the [MENU] key to show the menu.
2. Press the SYSTEM CONFIGURATION soft key.
3. Press the SYSTEM SETUP soft key.
4. Press the TEST & CLEAR soft key.
5. Press the TEST PATTERN soft key to show the test pattern.
6. Push the [ENTER] knob consecutively to show white, red, green, blue and black colors individually.
7. Press the RETURN soft key.
8. Press the [MENU] key to close the menu.

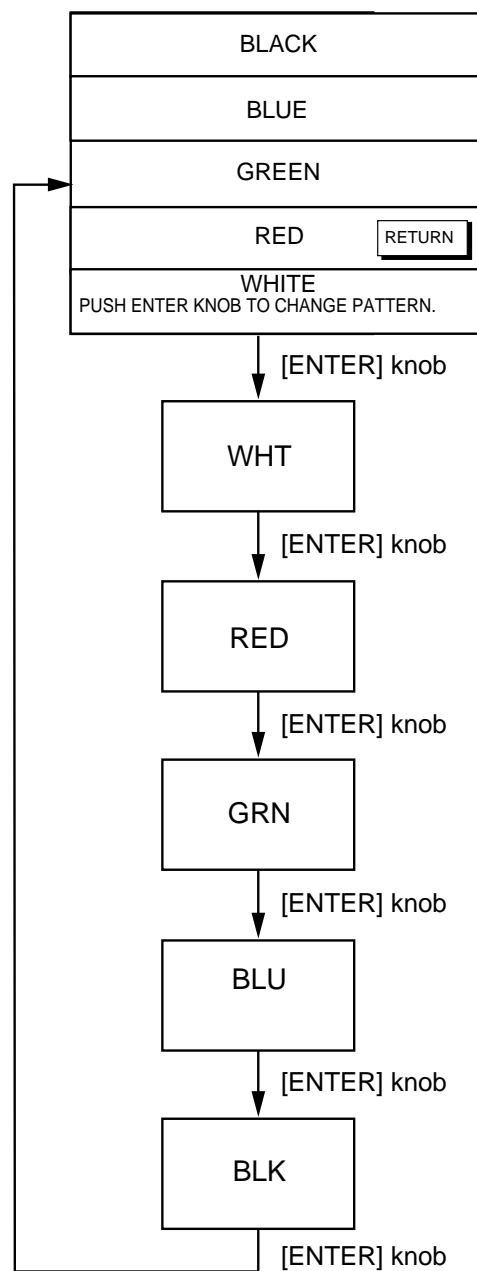

*Test pattern sequence*

### 7.6.3 Keyboard, remote controller test

The keyboard test checks the controls on the display unit and remote controller for proper operation.

1. Press the [MENU] key to show the menu.
2. Press the SYSTEM CONFIGURATION soft key.
3. Press the SYSTEM SETUP soft key.
4. Press the TEST & CLEAR soft key.
5. Press the KEYBOARD & REMOTE TEST soft key.

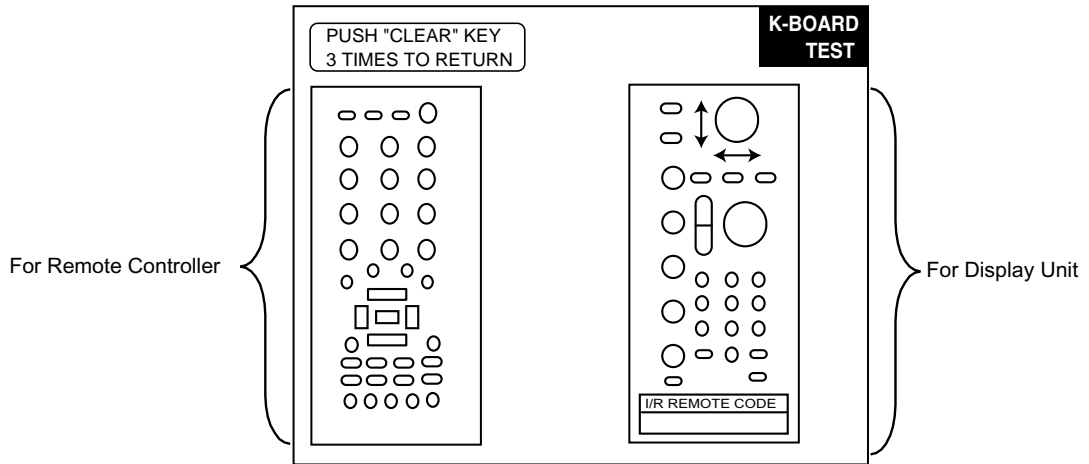

*Screen for testing keyboard, remote controller*

6. Operate each control on the keyboard and remote controller one by one. A key is functioning properly if its on-screen location "fills" in black when the key is pressed. For the [ENTER] knob and trackball, rotate them to show their X-Y positions digitally, and push the [ENTER] knob to confirm its function.
7. Press the [CLEAR] key three times on the display unit or remote controller to escape from the test.
8. Press the [MENU] key to close the menu.

## 7.7 GPS Status Display

The GPS status display provides data about the GPS satellites. It is available with connection of the GPS Receiver GP-310B/320B or a GPS navigator outputting the data sentence GSA or GSV.

1. Press the [MENU] key.
2. Press the SYSTEM CONFIGURATION, NAV OPTION and GPS SENSOR SETTINGS soft keys to display the GPS SENSOR SETTINGS menu.
3. Press the GPS STATUS soft key.

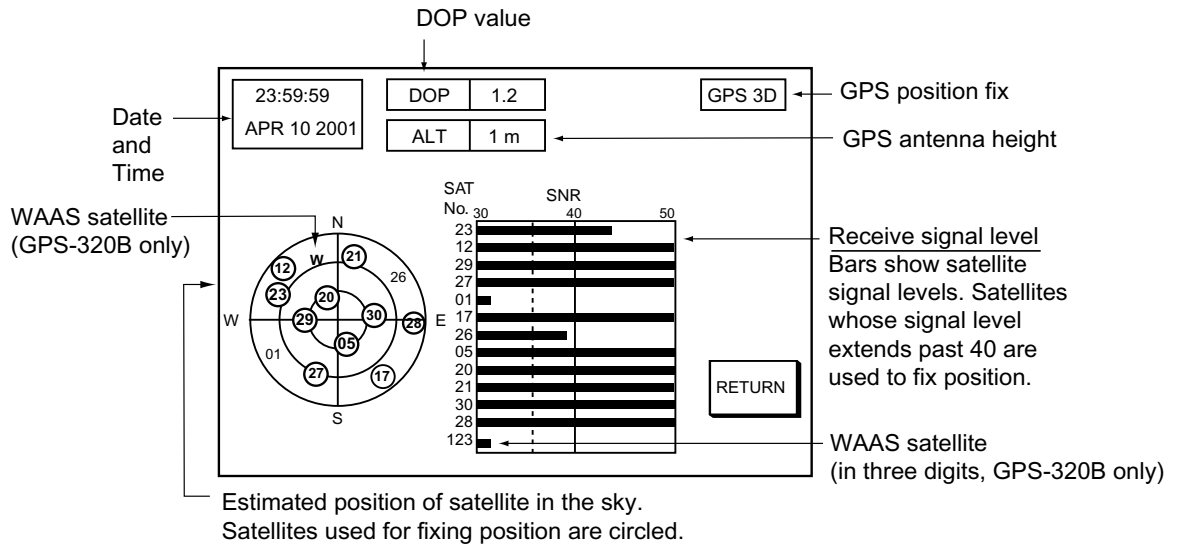

*GPS status display*

4. Press the RETURN soft key to quit the GPS status display.

## 7.8 Clearing Memories

Your equipment has a memory for each of the plotter, radar and sounder sections. These memories can be cleared to restart operation with default settings.

The following data are not cleared: **Radar**; Heading adjustment, timing adjustment, MBS level, tuning point, tuning indication (short, medium, long), video level, dead sector, antenna height, STC curve, antenna type, on time, tx time, **Sounder**; White marker, hue, signal level, TLL output, depth calibration, range.

1. Press the [MENU] key to open the menu.
2. Press the SYSTEM CONFIGURATION soft key.
3. Press the SYSTEM SETUP soft key.
4. Press the TEST & CLEAR soft key.
5. Press the MEMORY CLEAR soft key.

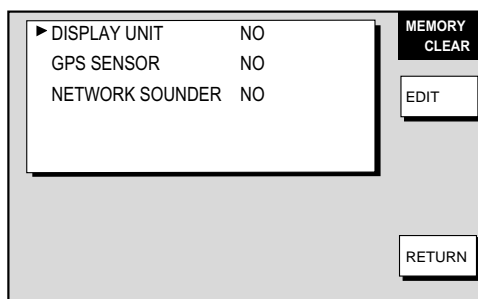

*Memory clear menu*

6. Use the trackball to choose the memory to clear.
7. Press the EDIT soft key.
8. Use the trackball to select YES, then press the ENTER soft key. One of the following displays appears depending on the selection made at step 6.

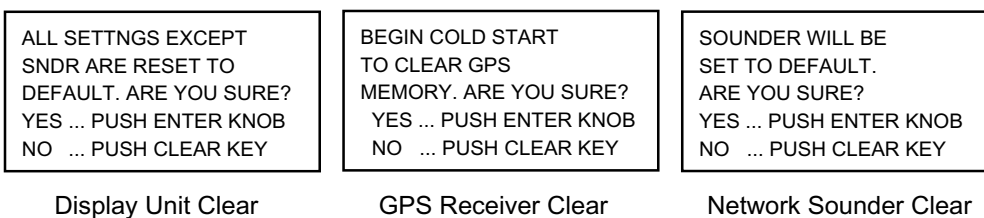

*Windows for clearing memory*

9. Push the [ENTER] knob to clear the memory selected.
10. Press the [MENU] key to close the menu.
11. Turn the power off and on again.

**Note:** Though the message “SYSTEM HAS FAILED START UP TEST. PLEASE CONTACT A LOCAL FURUNO REPRESENTATIVE FOR REPAIR. PUSH ANY KEY TO CONTINUE” may appear when powering on the display unit immediately after the clearing memories, there is no problem in fact. Press any key to continue the operation.

## 7.9 Error Messages

In addition to alarm messages your equipment also displays error messages.

### Error messages

<b>Error Message</b>	<b>Meaning</b>	<b>Remedy</b>
Connection with the ETR was cut.	Network sounder disconnected.	<ul style="list-style-type: none"> <li>• Check that display unit where the sounder is connected is turned on.</li> <li>• Check network sounder's cabling.</li> </ul>
Connection with the RADAR was cut.	Radar disconnected.	<ul style="list-style-type: none"> <li>• Check that display unit where the radar is connected is turned on.</li> <li>• Check antenna cable.</li> </ul>
Low Voltage! Internal Battery	Voltage of battery on circuit board in display unit is low.	Have a qualified technician replace the battery.
No bearing pulse detected.	No bearing pulse from radar antenna.	Check antenna cable.
No GPS fix!	GPS navigator is turned off or no GPS position data.	There may be obstacles around GPS antenna.
No position data.	An error may occur on GP-310B/320B.	Disconnect GPS cable from the display unit, and then contact your dealer.
No heading pulse detected.	No heading pulse	Check heading sensor.
HEADING DATA MISSING!		Check heading cable.

## 7. MAINTENANCE, TROUBLESHOOTING

This page is intentionally left blank.



# APPENDIX

## Menu Overview

### MENU key

#### Radar

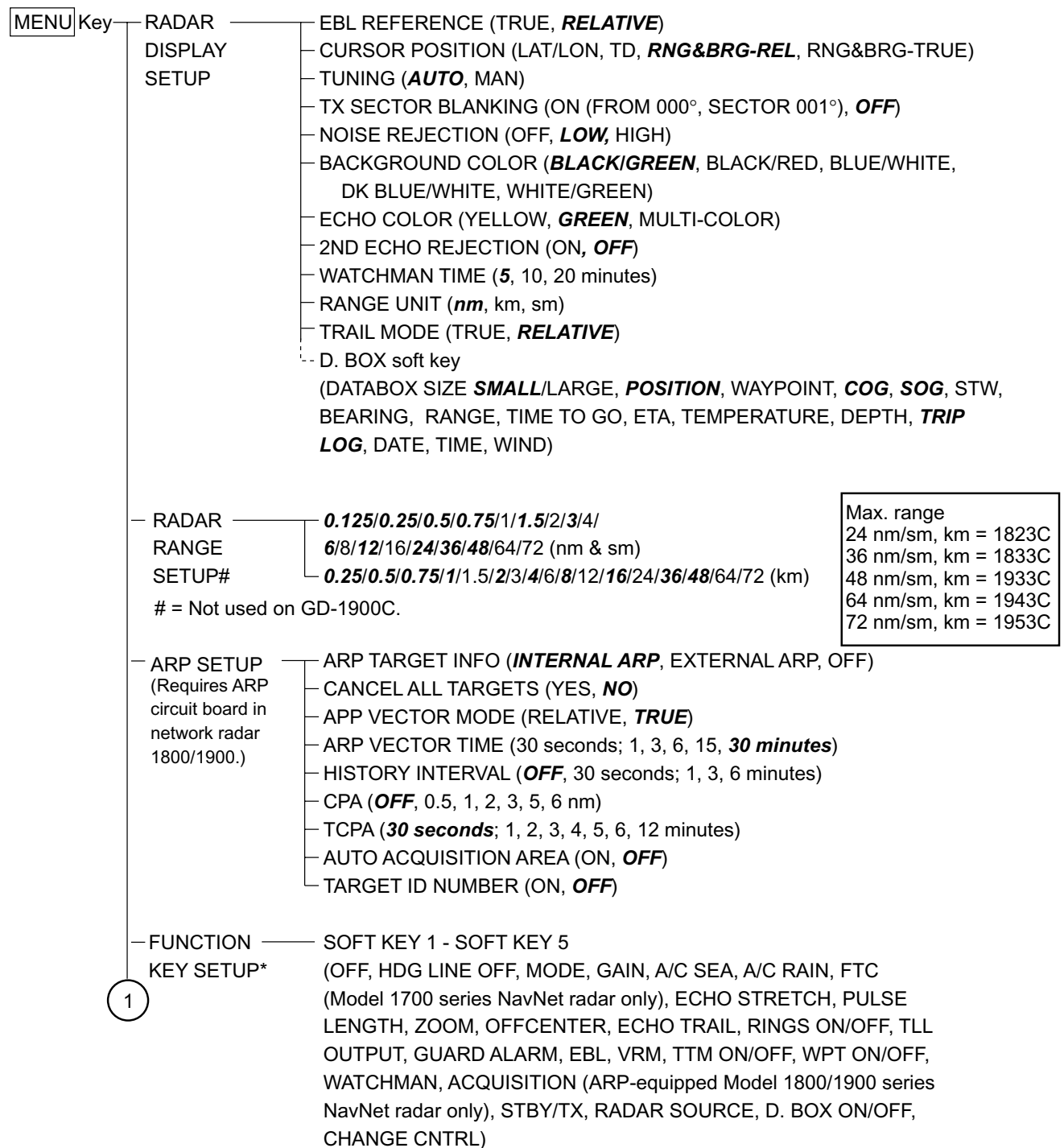

1

\* Default settings for function keys:  
 SOFT KEY 1, HDG LINE OFF; SOFT KEY 2, RINGS ON/OFF; SOFT KEY 3, ECHO TRAIL;  
 SOFT KEY 4, OFFCENTER, SOFT KEY 5, RADAR SOURCE

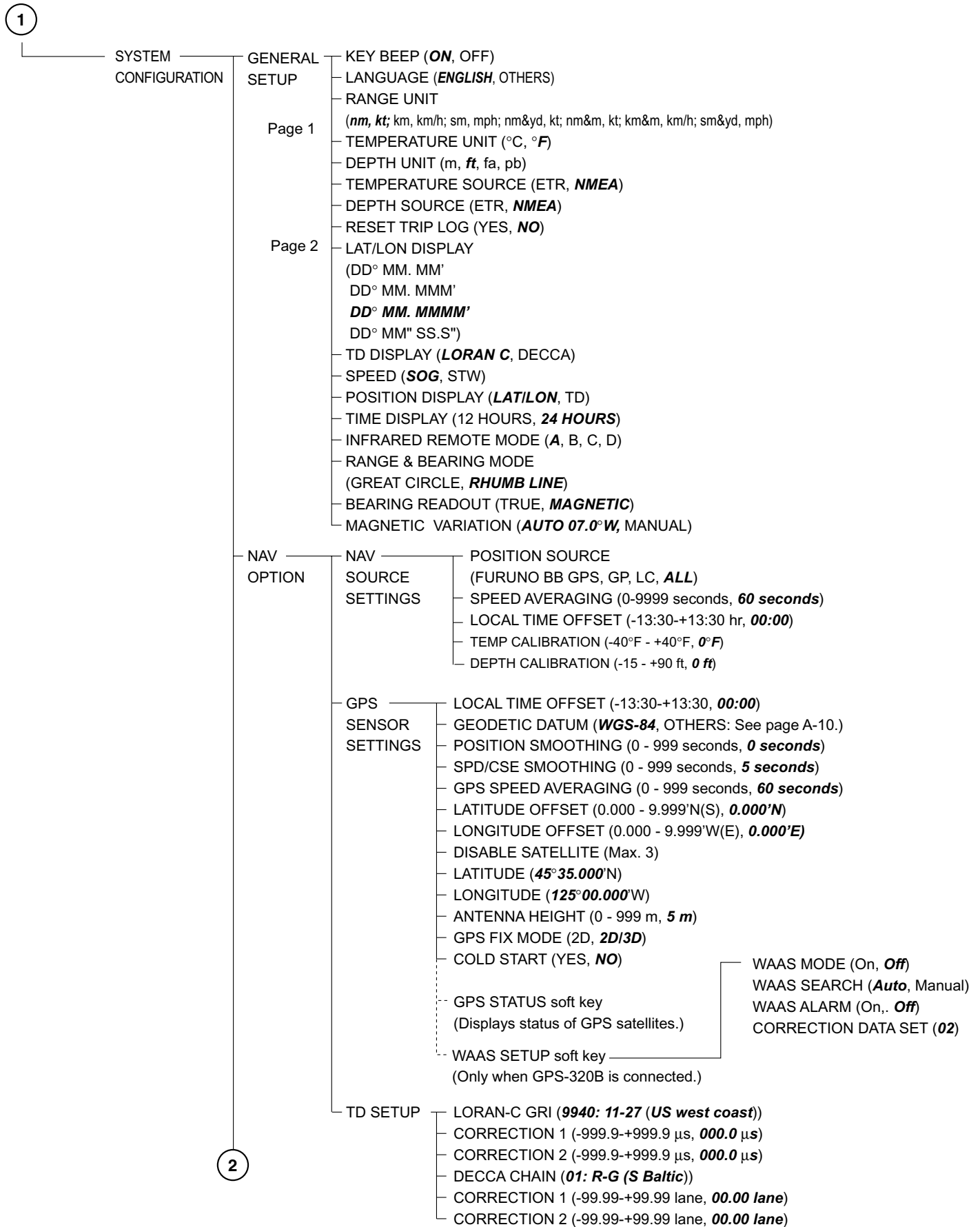

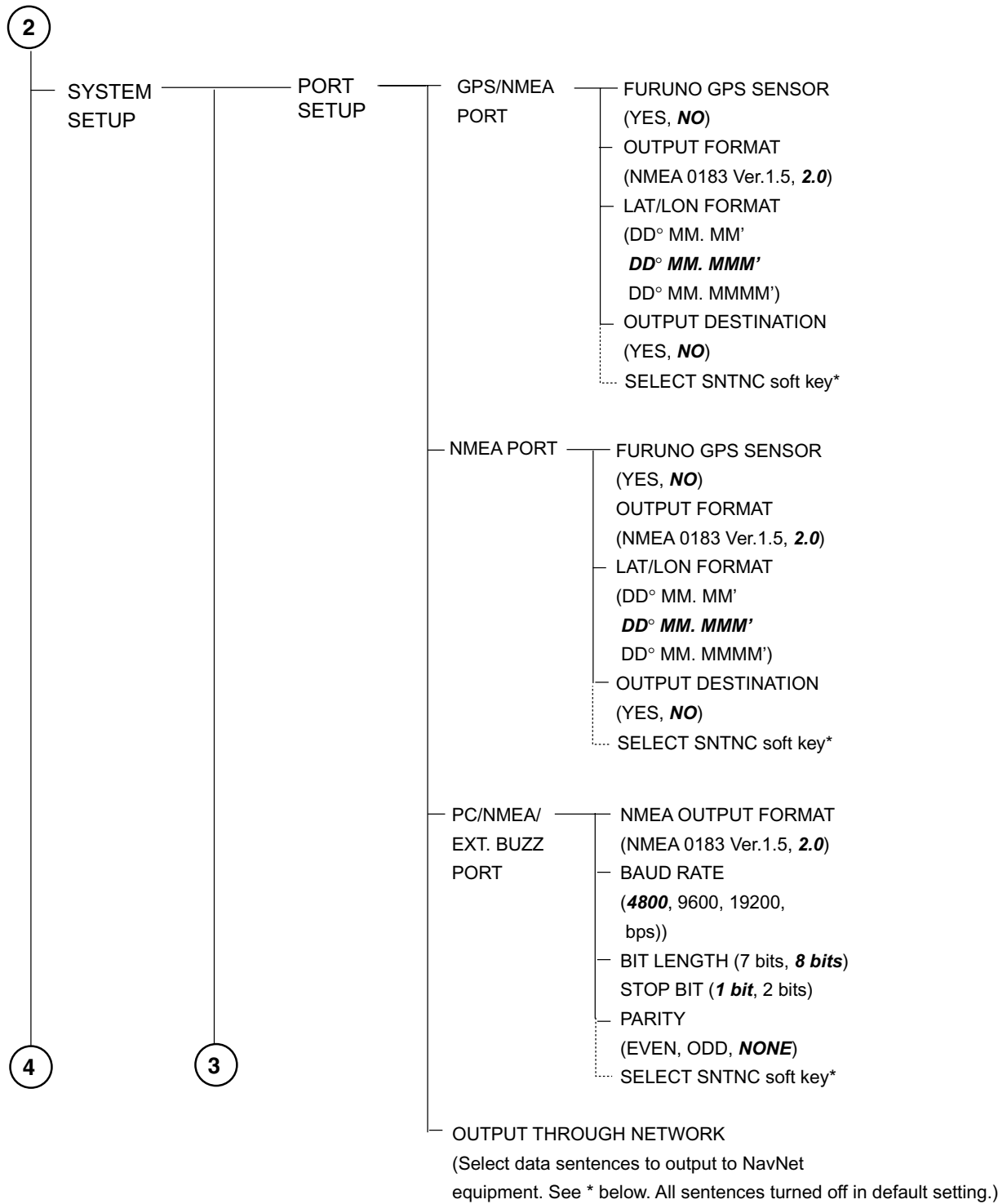

\* = AAM, **APB**, BOD, BWR(BWC)#1, DPT(DBT)#2, GGA, **GLL**, GTD, MTW, RMA, **RMB**, **RMC**, VHW, **VTG**, WPL, XTE, **ZDA**, HDT, HDG, MWV

#1= BWR for rhumb line, BWC for great circle

#2 = DBT for NMEA Ver. 1.5; DPT for NMEA Ver. 2.0

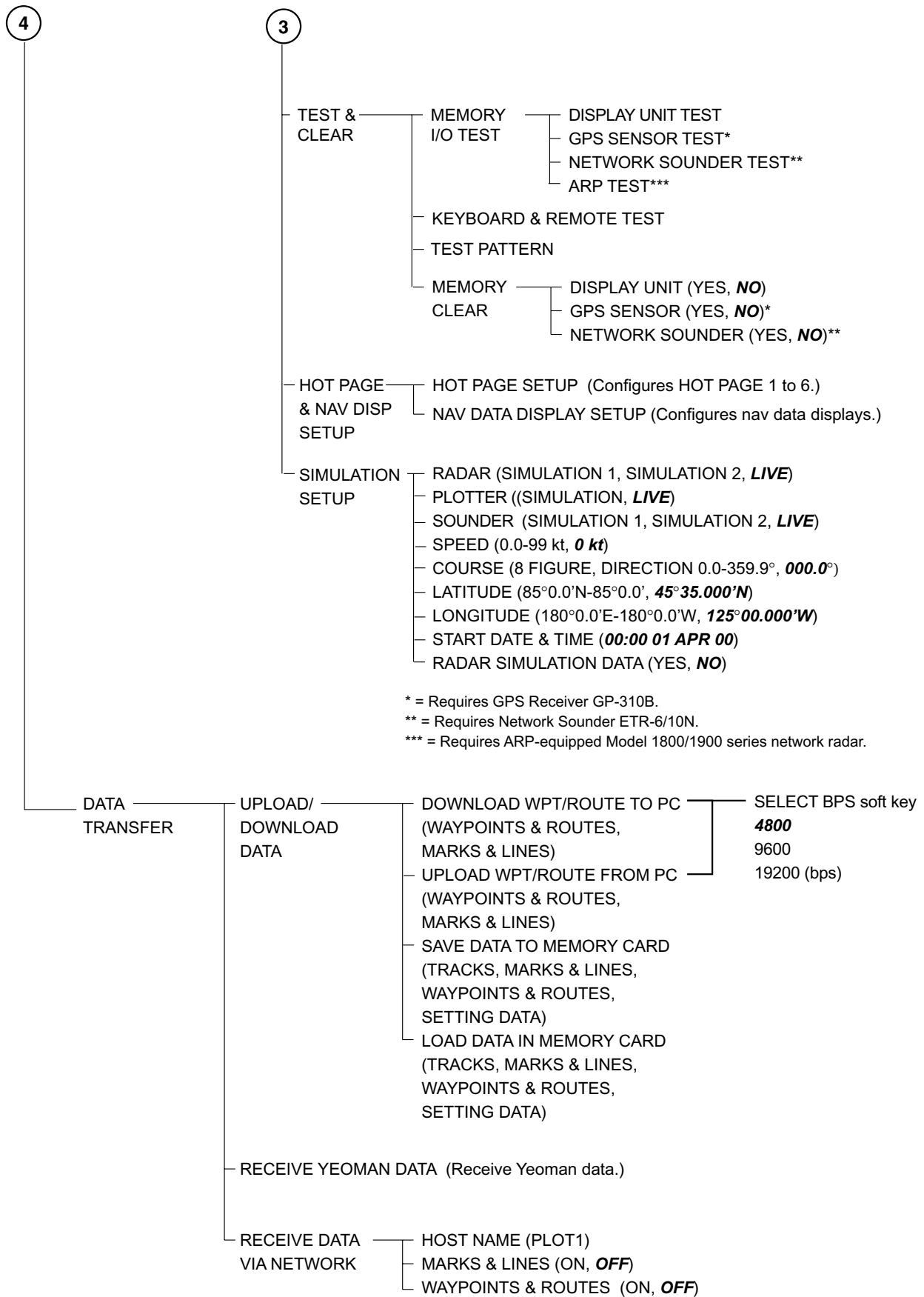

**Plotter**

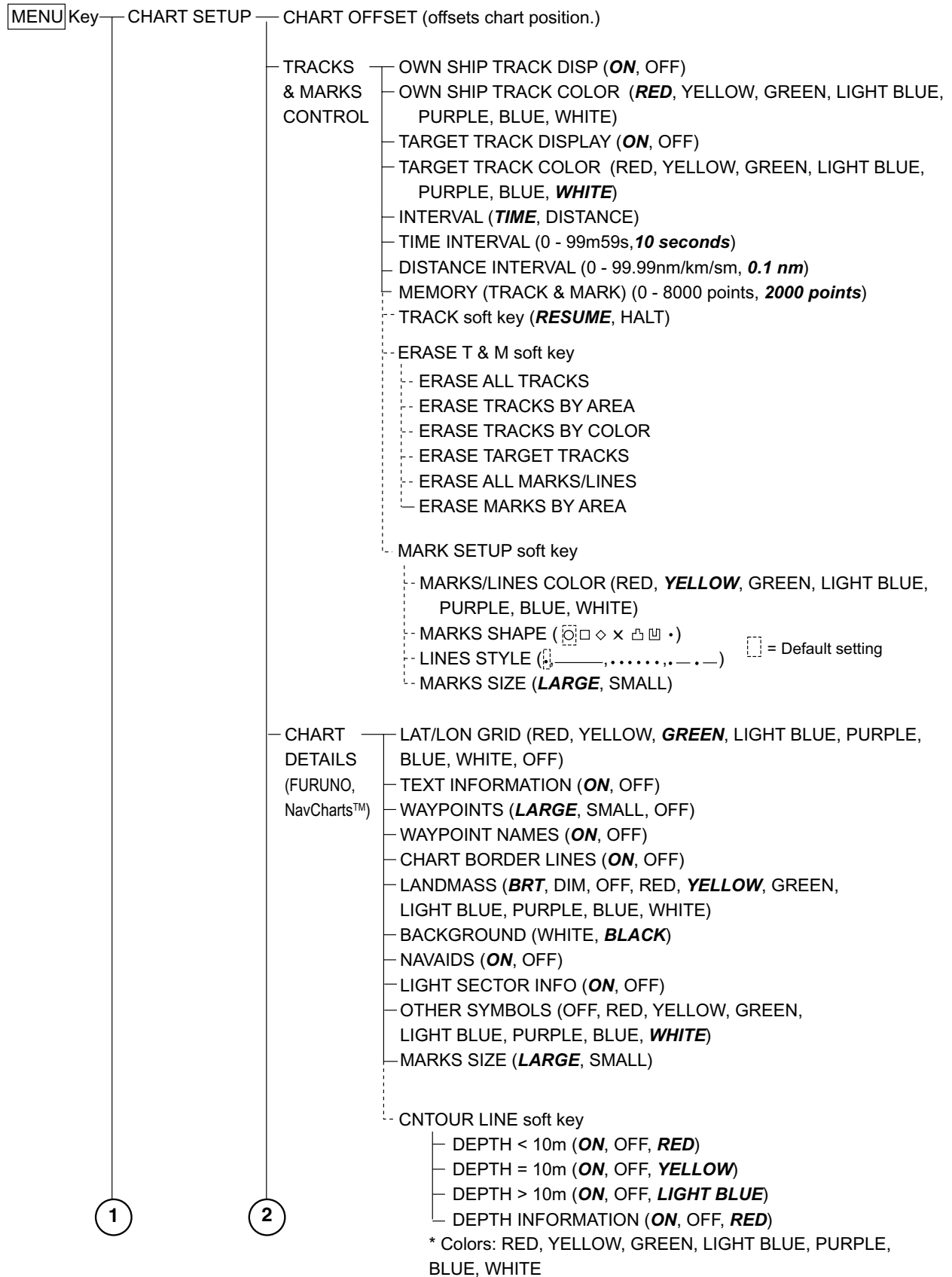

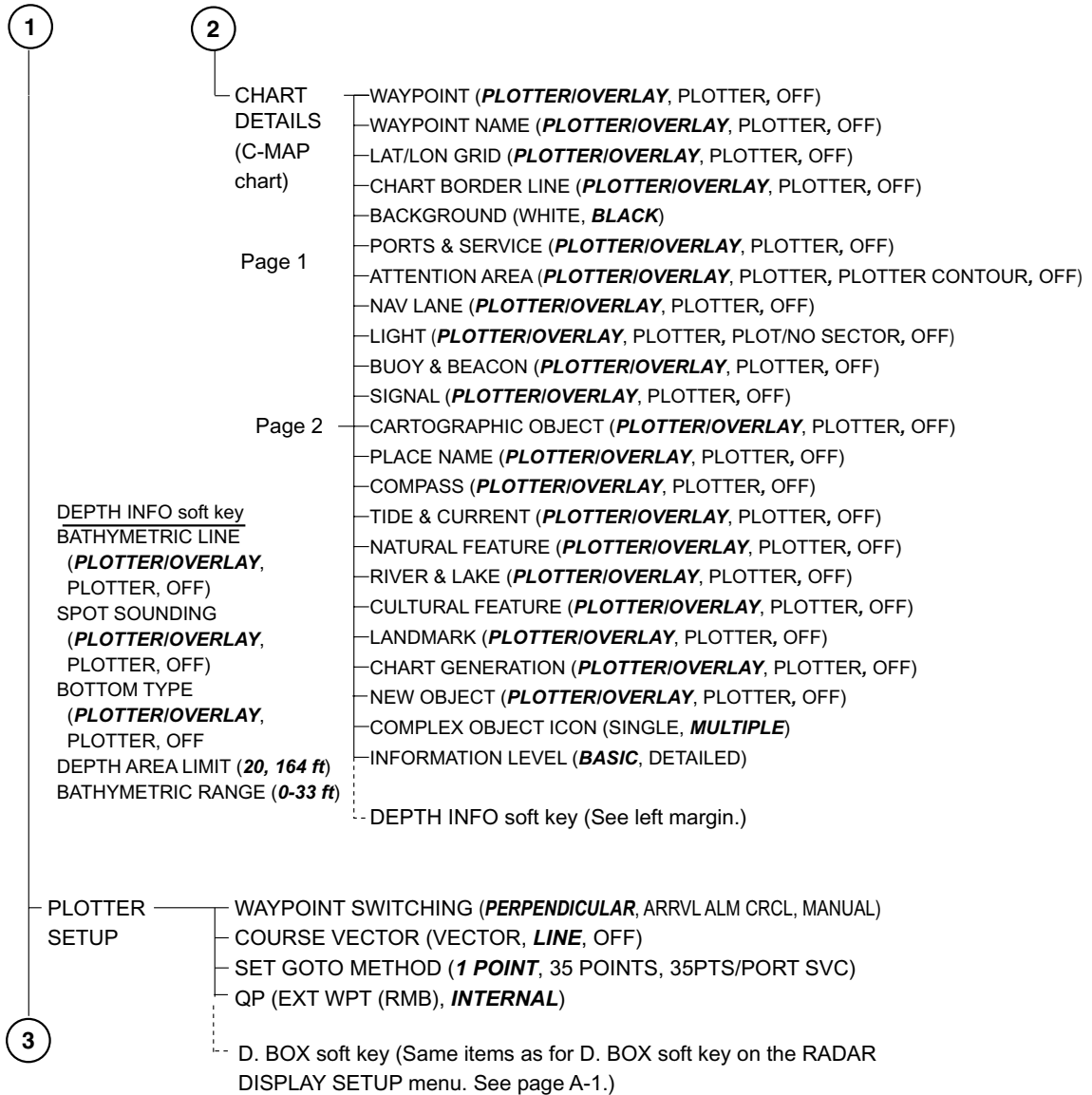

3

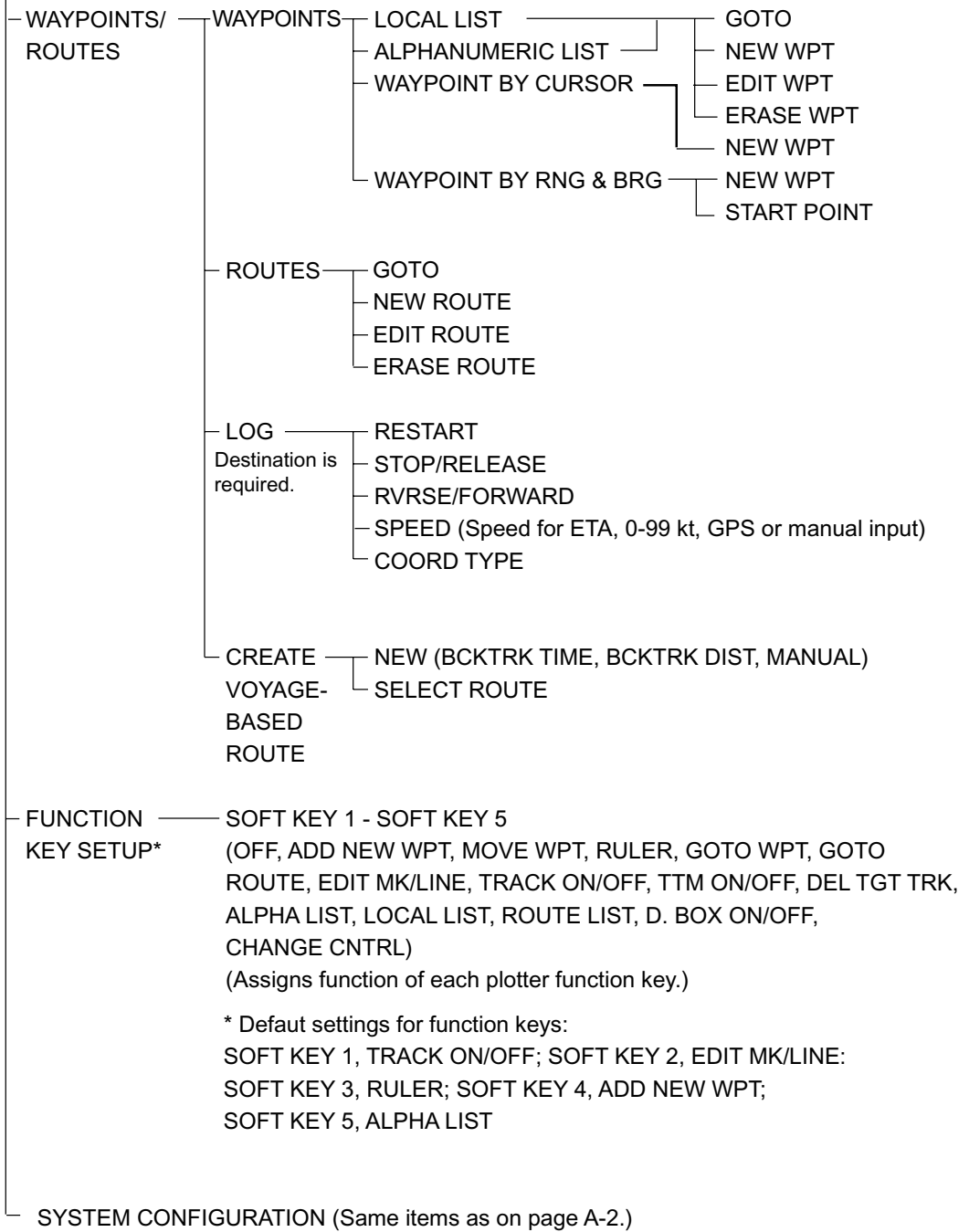

**Sounder**

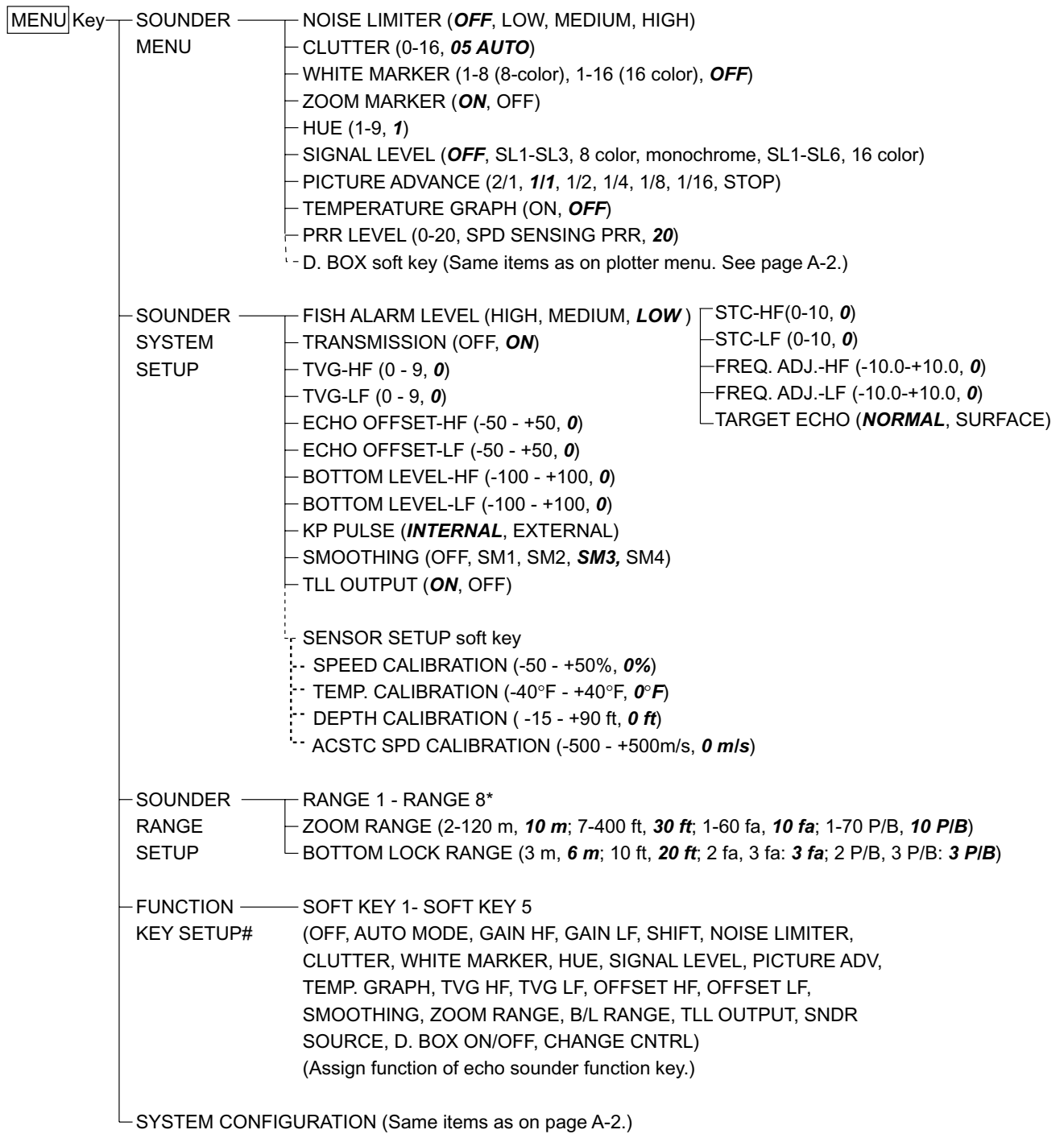

\* = Default sounder ranges

Range 1	Range 2	Range 3	Range 4	Range 5	Range 6	Range 7	Range 8	
							ETR-6/10N	ETR-30N
5 m	10 m	20 m	40 m	80 m	150 m	300 m	1200 m	1500 m
15 ft	30 ft	60 ft	120 ft	200 ft	400 ft	1000 ft	4000 ft	4500 ft
3 fa	5 fa	10 fa	20 fa	40 fa	80 fa	150 fa	650 fa	900 fa
3 P/B	5 P/B	10 P/B	30 P/B	50 P/B	100 P/B	200 P/B	700 P/B	900 P/B

# Default settings for function keys:

SOFT KEY 1, TLL OUTPUT; SOFT KEY 2, CLUTTER; SOFT KEY 3, SIGNAL LEVEL;  
SOFT KEY 4, NOISE LIMITER, SOFT KEY 5, PICTURE ADV



**EXT VIDEO**

**MENU** Key — CONFIGURATION — (Same items as on page A-2.)

**ALARM key****Radar Alarms**

**ALARM** key — SET GUARD 1 (ERASE GUARD 1)  
 — SET GUARD 2 (ERASE GUARD 2)

**Plotter Alarms**

**ALARM** key — AUDIO ALARM (INT & EXT BUZZ, **INTERNAL BUZZ**, OFF)  
 — ARRIVAL ALARM (ON, **OFF**, default range: 0.010 nm(km/sm))  
 — ANCHOR WATCH ALARM (ON, **OFF**, default range: 0.010 nm(km/sm))  
 — PROXIMITY ALARM (ON, **OFF**)  
 — XTE ALARM (ON, **OFF**, default range: 0.050 nm(km/sm))  
 — SPEED ALARM (WITHIN, UNDER/OVER, **OFF**)  
 — TRIP ALARM (ON, **OFF**)  
 — BOTTOM ALARM (ON, **OFF**)  
 — TEMPERATURE ALARM (WITHIN RANGE, OUT OF RANGE, **OFF**)  
 ..... NEXT INFO soft key (Shows which alarms have been violated.)  
 ..... CLEAR ALARM soft key (Acknowledges violated alarm.)

**Sounder Alarms**

**ALARM** key — AUDIO ALARM (INT & EXT BUZZ, **INTERNAL BUZZ**, OFF)  
 — BOTTOM ALARM (ON, **OFF**)  
 — TEMPERATURE ALARM (WITHIN RANGE, OUT OF RANGE, **OFF**)  
 — FISH ALARM (ON, **OFF**)  
 — FISH ALARM (B/L) (ON, **OFF**)  
 ..... NEXT INFO soft key (Shows which alarms have been violated.)  
 ..... CLEAR ALARM soft key (Acknowledges violated alarm.)







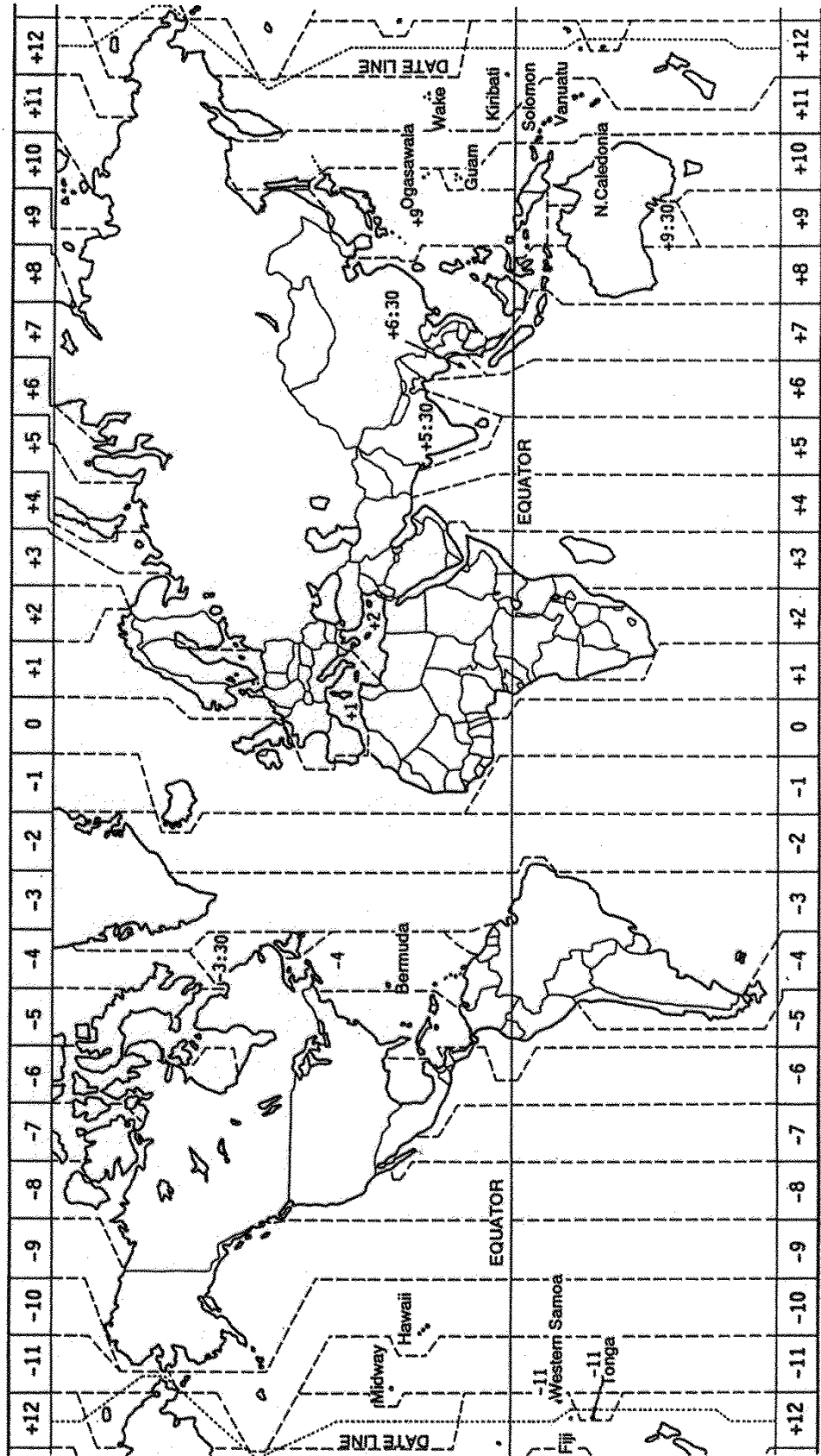

# Geodetic Chart List

001: WGS84	087: MAPARIMA, BWI : Trinidad and Tobago
002: WGS72	088: NORTH AMERICAN 1927 : Western United States
003: TOKYO : Mean Value (Japan, Korea, and Okinawa)	089: : Eastern United States
004: NORTH AMERICAN 1927 : Mean Value (CONUS)	090: : Alaska
005: EUROPEAN 1950 : Mean Value	091: : Bahamas (Excluding San Salvador Island)
006: AUSTRALIAN GEODETIC 1984 : Australia and Tasmania Island	092: : Bahamas San Salvador Island
007: ADINDAN : Mean Value (Ethiopia and Sudan)	093: : Canada (Including Newfoundland Island)
008: : Ethiopia	094: : Alberta and British Columbia
009: : Mali	095: : East Canada
010: : Senegal	096: : Manitoba and Ontario
011: : Sudan	097: : Northwest Territories and Saskatchewan
012: AFG : Somalia	098: : Yukon
013: AIN EL ABD 1970 : Bahrain Island	099: : Canal Zone
014: ANNA 1 ASTRO 1965 : Cocos Island	100: : Caribbean
015: ARC 1950 : Mean Value	101: : Central America
016: : Botswana	102: : Cuba
017: : Lesotho	103: : Greenland
018: : Malawi	104: : Mexico
019: : Swaziland	105: NORTH AMERICAN 1983 : Alaska
020: : Zaire	106: : Canada
021: : Zambia	107: : CONUS
022: : Zimbabwe	108: : Mexico, Central America
023: ARC 1960 : Mean Value (Kenya, Tanzania)	109: OBSERVATORIO 1966 : Corvo and Flores Islands (Azores)
024: : Kenya	110: OLD EGYPTIAN 1930 : Egypt
025: : Tanzania	111: OLD HAWAIIAN : Mean Value
026: ASCENSION ISLAND 1958 : Ascension Island	112: : Hawaii
027: ASTRO BEACON "E" : Iwo Jima Island	113: : Kaula
028: ASTRO B4 SOR. ATOLL : Tem Island	114: : Maui
029: ASTRO POS 71/4 : St. Helena Island	115: : Oahu
030: ASTRONOMIC STATION 1952 : Marcus Island	116: OMAN : Oman
031: AUSTRALIAN GEODETIC 1966 : Australia and Tasmania Island	117: ORDNANCE SURVEY OF GREAT BRITAIN 1936 : Mean Value
032: BELLEVUE (IGN) : Elate and Erromango Islands	118: : England
033: BERMUDA 1957 : Bermuda Islands	119: : England, Isle of Man, and Wales
034: BOGOTA OBSERVATORY : Colombia	120: : Scotland and Shetland Islands
035: CAMPO INCHAUSPE : Argentina	121: : Wales
036: CANTON ISLAND 1966 : Phoenix Islands	122: PICO DE LAS NIVIES : Canary Islands
037: CAPE : South Africa	123: PITCAIRN ASTRO 1967 : Pitcairn Island
038: CAPE CANAVERAL : Mean Value (Florida and Bahama Islands)	124: PROVISIONAL SOUTH CHILEAN 1963 : South Chile (near 53° s)
039: CARTHAGE : Tunisia	125: PROVISIONAL SOUTH AMERICAN 1956 : Mean Value
040: CHATHAM 1971 : Chatham Island (New Zealand)	126: : Bolivia
041: CHUAASTRO : Paraguay	127: : Chile Northern Chile (near 19° s)
042: CORREGO ALEGRE : Brazil	128: : Chile Southern Chile (near 43° s)
043: DJAKARTA (BATAVIA) : Sumatra Island (Indonesia)	129: : Colombia
044: DOS 1968 : Gizo Island (New Georgia Island)	130: : Ecuador
045: EASTER ISLAND 1967 : Easter Island	131: : Guyana
046: EUROPEAN 1950 (Cont'd) : Western Europe	132: : Peru
047: : Cyprus	133: : Venezuela
048: : Egypt	134: PUERTO RICO : Puerto Rico and Virgin Islands
049: : England, Scotland, Channel, and Shetland Islands	135: QATAR NATIONAL : Qatar
050: : England, Ireland, Scotland, and Shetland Islands	136: QORNOQ : South Greenland
051: : Greece	137: ROME 1940 : Sardinia Islands
052: : Iran	138: SANTNA BRAZ : Sao Maguel, Santa Maria Islands (Azores)
053: : Italy Sardinia	139: SANTO (DOS) : Espirito Santo Island
054: : Italy Sicily	140: SAPPER HILL 1943 : East Falkland Island
055: : Norway and Finland	141: SOUTH AMERICAN 1969 : Mean Value
056: : Portugal and Spain	142: : Argentina
057: EUROPEAN 1979 : Mean Value	143: : Bolivia
058: GANDAJIKKA BASE : Republic of Maldives	144: : Brazil
059: GEODETIC DATUM 1949 : New Zealand	145: : Chile
060: GUAM 1963 : Guam Island	146: : Colombia
061: GUX 1 ASTRO : Guadalcanal Island	147: : Ecuador
062: HJORSEY 1955 : Iceland	148: : Guyana
063: HONG KONG 1963 : Hong Kong	149: : Paraguay
064: INDIAN : Thailand and Vietnam	150: : Peru
065: : Bangladesh, India, and Nepal	151: : Trinidad and Tobago
066: IRELAND 1956 : Ireland	152: : Venezuela
067: ISTS 073 ASTRO 1969 : Diego Garcia	153: SOUTH ASIA : Singapore
068: JHONSTON ISLAND 1961 : Johnston Island	154: SOUTHEAST BASE : Porto Santo and Medeira Islands
069: KANDAWALA : Sri Lanka	155: SOUTHWEST BASE : Faial, Graciosa, Pico, Sao Jorge, and Terceira Islands
070: KERGUELEN ISLAND : Kerguelen Island	156: TIMBALAI 1948 : Brunel and East Malaysia (Sarawak and Sadah)
071: KERTAU 1948 : West Malaysia and Singapore	157: TOKYO : Japan
072: LA REUNION : Mascarene Island	158: : Korea
073: L.C. 5 ASTRO : Cayman Brac Island	159: : Okinawa
074: LIBERIA 1964 : Liberia	160: TRISTAN ASTRO 1968 : Tristan da Cunha
075: LUZON : Philippines (Excluding Mindanao Island)	161: VITI LEVU 1916 : Viti Levu Island (Fiji Islands)
076: : Mindanao Island	162: WAKE-ENIWETOK 1960 : Marshall Islands
077: MAHE 1971 : Mahe Island	163: ZANDERIJ : Suriname
078: MARCO ASTRO : Salvage Islands	164: BUKIT RIMPAH : Bangka and Belitung Islands (Indonesia)
079: MASSAWA : Eritrea (Ethiopia)	165: CAMP PAREA ASTRO : Camp Mcmurdo Area, Antarctica
080: MERCHICH : Morocco	166: G. SEGARA : Kalimantan Islands (Indonesia)
081: MIDWAY ASTRO 1961 : Midway Island	167: HERAT NORTH : Afghanistan
082: MINNA : Nigeria	168: HU-TZU-SHAN : Taiwan
083: NAHRWAN : Masirah Island (Oman)	169: TANANARIVE OBSERVATORY 1925 : Madagascar
084: : United Arab Emirates	170: YACARE : Uruguay
085: : Saudi Arabia	171: RT-90 : Sweden
086: NAMIBIA : Namibia	172: : Pulkovo 1942 : Russia

# World Time Chart

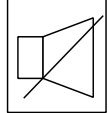
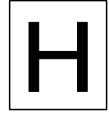
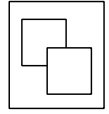

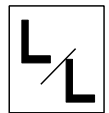
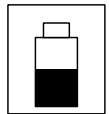
## Icons

Icon	Meaning
	North marker. Points to North.
	Correct chart and suitable scale - full chart reliability.
	Chart overenlarged.
	Chart card not inserted. Wrong chart card inserted. Chart scale too small.
	Plotter, radar, sounder alarm setting violated.
	Track is not being recorded or plotted.
	Chart offset applied.
	Voyage-based route currently being created.
	Latitude and longitude position offset applied.
	Voltage of battery on circuit board in display unit is low. Contact your dealer about replacement.
	Simulation mode.

# SPECIFICATIONS OF MARINE RADAR MODEL 1800C/1900C SERIES

## 1 GENERAL

1.1 Indication System PPI Daylight display, raster scan, color LCD

1.2 Range, Pulse length (PL) & Pulse Repetition Rate (PRR)

Range (nm)	Pulse length ( $\mu$ s)	PRR (Hz approx.)
0.125 to 1.5	0.08	2100
1.5 to 3	0.3	1200
3 to 72*	0.8	600

\*Maximum Range: M1823C: 24nm, M1833C: 36nm, M1933C: 48nm, M1943C: 64nm,  
M1953C: 72nm

1.3 Range Resolution M1823C: 10 m, Others: 15 m

1.4 Bearing Resolution M1823C: 5.5°, M1833C: 4.0°, M1933C: 2.4°, M1943C: 1.9°,  
M1953C: 1.9° (XN12A), 1.2° (XN13A)

1.5 Minimum Range M1823C: 27 m, Others: 42 m

1.6 Bearing Accuracy  $\pm 1^\circ$

1.7 Range Ring Accuracy 0.9 % of range or 8 m, whichever is the greater

## 2 ANTENNA UNIT

2.1 MODEL1823C:

2.1.1 Radiator Micro-strip

2.1.2 Polarization Horizontal

2.1.3 Antenna Rotation 30/24 rpm nominal (for short/long range)

2.1.4 Radiator Length 45 cm

2.1.5 Horizontal Beamwidth 5.2°

2.1.6 Vertical Beamwidth 25°

2.1.7 Sidelobe Attenuation -19 dB or less (within  $\pm 20^\circ$  of main-lobe)  
-21 dB or less ( $\pm 20^\circ$  of main-lobe or more)

2.2 MODEL1833C:

2.2.1 Radiator Printed waveguide array

2.2.2 Polarization Horizontal

2.2.3 Antenna Rotation 24 rpm nominal

2.2.4 Radiator Length 60 cm

2.2.5 Horizontal Beamwidth 3.9°

2.2.6 Vertical Beamwidth 20°

2.2.7 Sidelobe Attenuation -18 dB or less (within  $\pm 20^\circ$  of main-lobe)  
-23 dB or less ( $\pm 20^\circ$  of main-lobe or more)

2.3 MODEL1933C:

2.3.1	Radiator	Slotted waveguide array
2.3.2	Polarization	Horizontal
2.3.3	Antenna Rotation	24 or 48 rpm nominal High brilliance monitor: 24 rpm nominal only
2.3.4	Radiator Length	100 cm (XN10)
2.3.5	Horizontal Beamwidth	2.4°
2.3.6	Vertical Beamwidth	27°
2.3.7	Sidelobe Attenuation	-20 dB or less (within $\pm 20^\circ$ of main-lobe) -28 dB or less ( $\pm 20^\circ$ of main-lobe or more)

#### 2.4 MODEL1943C:

2.4.1	Radiator	Slotted waveguide array
2.4.2	Polarization	Horizontal
2.4.3	Antenna Rotation	24 or 48 rpm nominal High brilliance monitor: 24 rpm nominal only
2.4.4	Radiator Length	120 cm (XN12)
2.4.5	Horizontal Beamwidth	1.9°
2.4.6	Vertical Beamwidth	22°
2.4.7	Sidelobe Attenuation	-24 dB or less (within $\pm 20^\circ$ of main-lobe) -30 dB or less ( $\pm 20^\circ$ of main-lobe or more)

#### 2.5 MODEL1953C:

2.5.1	Radiator	Slotted waveguide array
2.5.2	Polarization	Horizontal
2.5.3	Antenna Rotation	24 or 48 rpm nominal
2.5.4	Radiator Length	120 cm (XN12), 180 cm (XN13, 24rpm only)
2.5.5	Horizontal Beamwidth	1.9° (XN12), 1.2° (XN13)
2.5.6	Vertical Beamwidth	22°
2.5.7	Sidelobe Attenuation	
	XN12:	-24 dB or less (within $\pm 20^\circ$ of main-lobe) -30 dB or less ( $\pm 20^\circ$ of main-lobe or more)
	XN13:	-24 dB or less (within $\pm 10^\circ$ of main-lobe) -30 dB or less ( $\pm 10^\circ$ of main-lobe or more)

### 3 TRANSCEIVER MODULE

3.1	Frequency and Modulation	9410 MHz $\pm 30$ MHz (X band), P0N
3.2	Peak Output Power	M1823C: 2.2 kW nominal, M1833C/1933C: 4 kW nominal, M1943C: 6 kW nominal, M1953C: 12 kW nominal
3.3	Modulator	FET Switching Method
3.4	Intermediate Frequency	60 MHz

- 3.5 Tuning Automatic or manual
- 3.6 Receiver Front End MIC (Microwave IC)
- 3.7 Bandwidth Tx pulselength 0.08  $\mu$ s and 0.3  $\mu$ s: 25 MHz  
Tx pulselength 0.8  $\mu$ s: 3 MHz
- 3.8 Duplexer Circulator with diode limiter
- 3.9 Warming up 90 s approx.

#### 4 DISPLAY UNIT

- 4.1 Display 10.4-inch rectangular TFT color LCD  
640(H) x 480(V) dots, Effective radar display dia.: 152 mm

##### 4.2 Range, Range Ring Interval (RI), Number of Rings

Range (nm)	0.125	0.25	0.5	0.75	1	1.5	2	3	4	6	8	12	16	24	36	48	64	72
RI (nm)	0.0625	0.125	0.125	0.25	0.25	0.5	0.5	1	1	2	2	3	4	6	12	12	16	18
Rings	2	2	4	3	4	3	4	3	4	3	4	4	4	4	3	4	4	4

Maximum range: M1823C: 24nm, M1833C: 36nm, M1933C: 48nm, M1943C: 64nm, M1953C: 72nm

- 4.3 Markers Heading Line, Bearing Scale, Range Rings,  
Variable Range Marker (VRM), Electronic Bearing Line (EBL),  
Alarm Zone, Waypoint Mark (navigation input required)
- 4.4 Alphanumeric Indications Range, Range Ring Interval, Interference Rejection (IR),  
Variable Range Marker (VRM), Electronic Bearing Line (EBL),  
Stand-by (ST-BY), Echo Averaging (EAV), TX Pulse width  
Guard Alarm (G(IN), G(OUT)), Echo Stretch (ES),  
Range and Bearing to Cursor or Cursor Position,  
Echo Trailing (TRAIL), Trailing Time,  
Data Box (Position, COG, SOG, STW etc. selectable on menu)
- 4.5 Input Data IEC 61162-1 (NMEA 0183 Ver1.5/2.0)
  - Own ship's position: GGA>RMC>RMA>GLL
  - Ship's speed: RMC>RMA>VTG>VHW
  - Bearing (True): HDT>HDG<sup>\*1</sup>>HDM<sup>\*1</sup>>VHW
  - Bearing (Magnetic): HDM>HDG<sup>\*1</sup>>HDT<sup>\*1</sup>>VHW
  - Course: RMC>RMA>VTG
  - Water depth: DPT>DBT>DBS>DBK
  - Wind: MWV>VWT>VWR
  - Water Temperature: MTW
  - Time: ZDA
- 4.6 Output Data
  - Alarm signal 12 VDC, 100 mA or less

\*1: calculated by magnetic deviation

NMEA 0183 Ver1.5      GGA, GLL, RMA, RMC, GTD, VTG, ZDA (GPS data required)  
 RMB, WPL, BWC or BWR, APB, AAM, BOD, XTE, VHW, MTW,  
 DPT or DBT, DBS (ETR required),  
 TLL (L/L, Heading data required), TTM (ARPA required)

## 5 PLOTTER FUNCTION

5.1	Projection	Mercator
5.2	Usable Area	85 latitude or below
5.3	Effective Area	211.2 x 158.4 mm
5.4	Display pixels	640 x 480 dots
5.5	Position Indication	Latitude/longitude, Loran C LOP or DECCA LOP
5.6	Effective Projection Area	0.125 nm to 1,024 nm (at equatorial area)
5.7	Track Display	Plot interval: by time (1 sec. to 99 min. 59 sec.) or by distance (0 to 99.9 nm)
5.8	Colors	Red, yellow, green purple, light-blue, blue, white
5.9	Memory Capacity	Track/mark: 8000 points, Waypoint: 999 points
5.10	Storage Capacity	Simple route: 200 routes with 35 waypoints each
5.11	MOB	1 point
5.12	Quick Routes	1 course with 35 waypoints max.
5.13	Electronic Chart	FURUNO chart card or NAVIONICS chart card available C-MAP chart card also available for C-MAP NT Model
5.14	Alarms	Arrival and Anchor watch, Cross track error and proximity alarms, Ship's speed in and out alarms, Water temperature, Trip alarm, Fish alarm, Bottom alarm (ETR required)

## 6 POWER SUPPLY

6.1	Rated Voltage/Current	
	M1823C	12-24 VDC: 5.5-2.7 A
	M1833C	12-24 VDC: 5.3-2.6 A (6.4-3.1 A)
	M1933C (24rpm)	12-24 VDC: 5.6-2.7 A (6.7-3.2 A)
	M1933C (48rpm)	12-24 VDC: 7.5-3.6 A
	M1943C (24rpm)	12-24 VDC: 6.3-3.1 A (7.4-3.5 A)
	M1943C (48rpm)	12-24 VDC: 8.1-3.8 A
	M1953C (24rpm)	12-24 VDC: 8.6-4.3 A
	M1953C (48rpm)	12-24 VDC: 10.3-5.1 A
		( ): for high brilliance monitor
6.2	Rectifier (option)	100-115/220-230 VAC, 1 phase, 50/60 Hz



## 7 ENVIRONMENTAL CONDITION

- 7.1 Ambient Temperature    Antenna Unit: -25°C to +70°C  
                                  Display Unit: -15°C to +55°C  
                                  Remote Controller: +5°C to +45°C  
                                  Power Supply Unit: -15°C to +55°C
- 7.2 Relative Humidity        93 % or less at +40°C
- 7.3 Waterproofing            Antenna Unit: IPX6  
                                  Display Unit: IPX5 (External monitor connected: IPX0)  
                                  Remote Controller, Power Supply Unit: IPX0
- 7.4 Bearing Vibration        IEC 60945-4<sup>th</sup>

## 8 COATING COLOR

- 8.1 Display Unit              N3.0
- 8.2 Antenna Unit
- M1823C/1833C            N9.5 (upper), 2.5PB3.5/10 (lower)
- M1933C/1943C/1953C    N9.5

## 9 COMPASS SAFE DISTANCE

- 9.1 Display Unit              Standard: 0.60 m    Steering: 0.40 m
- 9.2 Antenna Unit
- M1823C/1833C:            Standard: 0.90 m    Steering: 0.70 m
- M1933C/1943C/1953C:    Standard: 1.00 m    Steering: 0.75 m

# SPECIFICATIONS OF VIDEO PLOTTER GD-1900C

## 1 DISPLAY UNIT

1.1	Indication System	PPI Daylight display, raster scan, color LCD
1.2	Display	10.4-inch rectangular TFT color LCD, 640(H) x 480(V) dots
1.3	Input Data	IEC 61162-1 (NMEA 0183 Ver1.5/2.0)
	Own ship's position:	GGA>RMC>RMA>GLL
	Ship's speed:	RMC>RMA>VTG>VHW
	Bearing (True):	HDT>HDG <sup>*1</sup> >HDM <sup>*1</sup> >VHW
	Bearing (Magnetic):	HDM>HDG <sup>*1</sup> >HDT <sup>*1</sup> >VHW
	Course:	RMC>RMA>VTG
	Water depth:	DPT>DBT>DBS>DBK
	Wind:	MWV>VWT>VWR
	Water Temperature:	MTW
	Time:	ZDA
		<sup>*1</sup> : calculated by magnetic deviation
1.4	Output Data	
	Alarm signal	12 VDC, 100 mA or less
	NMEA 0183 Ver1.5	GGA, GLL, RMA, RMC, GTD, VTG, ZDA (GPS data required) RMB, WPL, BWC or BWR, APB, AAM, BOD, XTE, VHW, MTW, DPT or DBT, DBS (ETR required), TTM (ARPA required)

## 2 PLOTTER FUNCTION

2.1	Projection	Mercator
2.2	Usable Area	85 latitude or below
2.3	Effective Area	211.2 x 158.4 mm
2.4	Display pixels	640 x 480 dots
2.5	Position Indication	Latitude/longitude, Loran C LOP or DECCA LOP
2.6	Effective Projection Area	0.125 nm to 1,024 nm (at equatorial area)
2.7	Track Display	Plot interval: by time (1 sec. to 99 min. 59 sec.) or by distance (0 to 99.9 nm)
2.8	Colors	Red, yellow, green purple, light-blue, blue, white
2.9	Memory Capacity	Track/mark: 8000 points, Waypoint: 999 points
2.10	Storage Capacity	Simple route: 200 routes with 35 waypoints each
2.11	MOB	1 point
2.12	Quick Routes	1 course with 35 waypoints max.
2.13	Electronic Chart	FURUNO chart card or NAVIONICS chart card available C-MAP chart card also available for C-MAP NT Model
2.14	Alarms	Arrival and Anchor watch, Cross track error and proximity

alarms, Ship's speed in and out alarms, Water temperature,  
Trip alarm, Fish alarm, Bottom alarm (ETR required)

### **3 POWER SUPPLY**

- 3.1 Rated Voltage/Current 12-24 VDC: 2.1-1.1 A (3.1-1.6 A)  
( ): for high brilliance monitor
- 3.2 Rectifier (option) PR-62: 100/110/220/230 VAC, 1 phase, 50/60 Hz

### **4 ENVIRONMENTAL CONDITION**

- 4.1 Ambient Temperature -15°C to +55°C
- 4.2 Relative Humidity 93 % or less at +40°C
- 4.3 Waterproofing IPX5
- 4.4 Bearing Vibration IEC 60945-4<sup>th</sup>

### **5 COATING COLOR**

- 5.1 Display Unit N3.0

### **6 COMPASS SAFE DISTANCE**

- 6.1 Display Unit Standard: 1.00 m Steering: 0.80 m

This page is intentionally left blank.

# INDEX

---

## A

A/C RAIN .....	2-5
A/C SEA.....	2-4
ACQ soft key.....	2-35
ALARM key	
plotter .....	3-52
radar.....	2-29
sounder.....	4-20
Alarms	
anchor watch .....	3-54
arrival .....	3-53
audio .....	3-52
bottom .....	4-21
CPA/TCPA .....	2-42
fish .....	4-21
fish(B/L).....	4-22
guard.....	2-29
heading missing data.....	2-8
lost target .....	2-43
messages.....	3-59
messages (plotter) .....	3-59
messages (sounder) .....	4-25
proximity.....	3-56
speed .....	3-55
trip .....	3-56
water temperature.....	4-23
XTE (cross track error) .....	3-55
Anchor watch alarm .....	3-54
Antenna height (GPS Receiver GP-310B).....	5-24
ARP	
acquisition of targets .....	2-36
activating.....	2-35
ARP SETUP menu.....	2-35
CPA/TCPA alarm.....	2-42
data .....	2-41
deactivating.....	2-35
lost target alarm .....	2-43
past position display .....	2-40
test .....	7-8
tracking termination .....	2-38
vector .....	2-39
Arrival alarm.....	3-53
A-scope display.....	4-7

Audio alarm.....	3-52
Auto course-up mode .....	3-8
AUTO S.SPD soft key.....	2-20
AUTO/D. BOX soft key .....	4-9

## B

Battery replacement .....	7-1
Bearing measurement by EBL.....	2-14
Bearing reference .....	5-3
Bottom alarm .....	4-21
Bottom discrimination display .....	4-7
Bottom echo.....	4-26
Bottom-lock display.....	4-6
Bottom-zoom display .....	4-5
Brilliance .....	1-7

## C

CENTER soft key.....	1-13
CHART DETAILS menu.....	5-13
CHART OFFSET soft key.....	5-12
Charts	
C-MAP chart attributes .....	5-15
cursor and data display (C-MAP) .....	3-14
data for aids to navigation .....	3-12
FURUNO chart attributes .....	5-14
icon data (C-MAP) .....	3-15
icons .....	3-10
indices.....	3-11
inserting .....	1-5
NavCharts™ chart attributes .....	5-14
offsetting .....	5-12
port service icons.....	3-13
symbols for FURUNO, NavCharts™ .....	3-12
tide information (C-MAP) .....	3-16
CLEAR ALARM soft key .....	4-24
Clutter rejector .....	4-14
C-MAP charts	
attributes .....	5-15
cursor and data display .....	3-14
icon data .....	3-15
tide information .....	3-16
CNTOUR LINE soft key.....	5-14
Cold start (GPS Receiver GP-310B) .....	5-24

# INDEX

Colors		
radar display .....	5-5	
radar echoes .....	5-5	
sounder echoes .....	4-19	
Compass display .....	3-3	
Controls		
display unit .....	1-2	
remote controller .....	1-4	
Course-up mode		
plotter .....	3-8	
radar .....	2-9	
CPA/TCPA alarm .....	2-42	
Cursor		
display format .....	5-4	
shifting .....	1-13	
CURSOR soft key .....	2-18	
<b>D</b>		
Data boxes		
erasing .....	1-16	
hiding .....	1-15	
rearranging .....	1-16	
setup .....	5-18	
showing .....	1-15	
DEPTH INFO soft key .....	5-17	
Depth measurement .....	4-12	
Depth source .....	5-2	
Depth unit .....	5-2	
Diagnostics		
ARP test .....	7-8	
display unit test .....	7-7	
GPS sensor test .....	7-7	
keyboard test .....	7-10	
network sounder test .....	7-8	
test menu .....	7-6	
test pattern .....	7-9	
DISP key .....	1-10	
Display modes .....	1-9	
Display unit test .....	7-7	
DISPLY MODE soft key .....	4-2	
Downloading data .....	6-5	
Dual frequency display .....	4-4	
<b>E</b>		
E. AVG soft key .....	2-27	
E. STR soft key .....	2-26	
EBL reference .....	5-4	
EBL soft key .....	2-14	
EBL/VRM key .....	2-13, 2-14, 2-21, 2-22	
Echo averaging .....	2-27	
Echo offset (sounder) .....	5-29	
Echo stretch .....	2-26	
Echo trails		
color .....	2-25	
mode .....	2-25	
starting .....	2-24	
time .....	2-23	
EDIT XT-LMT soft key .....	3-4, 3-5	
Error messages .....	7-13	
ETA calculation .....	3-50	
<b>F</b>		
Fish alarm		
sensitivity .....	5-28	
setting .....	4-21	
Fish alarm (B/L)		
sensitivity .....	5-28	
setting .....	4-22	
Fish school echo .....	4-27	
Fix mode (GPS Receiver GP-310B) .....	5-24	
Formatting memory cards .....	6-1	
FREQ LF/HF soft key .....	4-3	
Function keys		
function execution .....	1-17	
setup (plotter) .....	5-10	
setup (radar) .....	5-7	
setup (sounder) .....	5-32	
Fuse replacement .....	7-2	
<b>G</b>		
GAIN key		
radar .....	2-2	
sounder .....	4-10, 4-11	
GENERAL SETUP menu .....	5-1	
Geodetic datum (GPS Receiver GP-310B) ..	5-22	
Geodetic datum codes .....	A-10	
GPS Receiver GP-310B setup .....	5-22	
GPS sensor (GP-310B) test .....	7-7	
GPS SETUP menu .....	5-22	
GPS status display .....	7-11	
Guard alarm		
cancelling .....	2-30	
setting .....	2-29	
<b>H</b>		
Heading line .....	2-16	
Head-up mode .....	2-9	
Highway display .....	3-5	

- HIWAY CNTRL soft key .....3-5
- HL OFF soft key .....2-16
- Hot page setup .....5-19
- Hue
- radar, plotter .....1-8
  - sounder .....4-19
- I**
- I. REJ. soft key .....2-17
- Icons ..... A-12
- Interference rejection
- radar .....2-17
  - sounder .....4-13
- K**
- Keyboard test .....7-10
- Keying pulse .....5-29
- L**
- Language .....5-2
- Latitude, longitude display .....5-2
- Lines
- entering .....3-25
  - erasing .....3-27
  - type .....3-26
- LOAD DATA menu .....6-4
- Local time
- GPS Receiver GP-310B .....5-22
  - navigator (GPS, Loran C) .....5-21
- Lost target alarm .....2-43
- M**
- Magnetic variation .....5-3
- Maintenance
- battery replacement .....7-1
  - fuse replacement .....7-2
  - preventive .....7-1
  - trackball .....7-2
- Marker-zoom display .....4-5
- Marks
- color .....3-25
  - entering .....3-25
  - erasing all .....3-27
  - erasing individual .....3-27
  - shape .....3-25
- Memory
- clearing .....7-12
  - testing .....7-6
- Memory cards
- error messages .....6-3
  - formatting .....6-1
  - playing back .....6-4
  - saving data to .....6-2
- Memory I/O test .....7-6
- Menu tree .....A-1
- Messages
- memory cards .....6-3
  - plotter alarms .....3-59
  - sounder alarms .....4-25
- MOB mark .....1-14
- Multiple echoes (radar) .....2-46
- N**
- Nav data display .....3-6
- NAV DATA menu .....5-27
- Nav data source .....5-21
- Nav data window .....3-2
- NAV OPTION menu .....5-21
- Navigation
- canceling route navigation .....3-51
  - port, port services .....3-46
  - quick point .....3-44
  - restarting .....3-49
  - routes .....3-48
  - switching waypoints in a route .....3-50
  - waypoints .....3-45
- Navigator setup .....5-21, 5-22
- NavNet
- image source .....1-12
  - receiving data from .....6-9
- Network sounder test .....7-8
- NEXT INFO soft key .....3-58, 4-24
- Noise limiter (sounder) .....4-13
- Noise rejection (radar) .....2-16
- North marker .....2-16
- North-up mode
- plotter .....3-7
  - radar .....2-10
- O**
- Offset EBL .....2-21
- OFFSET soft key .....2-21, 2-22
- P**
- Picture advance speed .....4-17
- PLOTTER SETUP menu .....5-9
- PLOTTR CNTRL soft key .....1-11

## INDEX

- Port, port services
  - icons.....3-13
  - navigating to.....3-46
- Position offset (GPS Receiver GP-310B) .....5-23
- Position smoothing (GPS Receiver GP-310B) .....5-23
- POWER/BRILL key ..... 1-6, 1-7
- Presentation mode
  - plotter .....3-7
  - radar.....2-8
- Proximity alarm .....3-56
- Pulselength (radar).....2-7
- R**
- Racon .....2-50
- RADAR SETTING menu.....5-3
- RADAR TX/ST-BY soft key .....2-2
- Range
  - measurement by cursor (radar) .....2-12
  - measurement by range rings (radar) .....2-11
  - measurement by VRM (radar) .....2-13
  - plotter .....3-9
  - radar.....2-6
  - setup (radar) .....5-6
  - setup (sounder) .....5-31
  - unit of measurement .....5-2
- RANGE key
  - plotter .....3-9
  - radar.....2-6
  - sounder .....4-10
- Remote controller
  - control description .....1-4
  - testing.....7-10
- RESET XTE soft key..... 3-4, 3-5
- RINGS soft key .....2-11
- Routes
  - cancelling navigation of.....3-51
  - connecting.....3-40
  - entering with cursor.....3-37
  - entering with existing waypoints .....3-36
  - erasing .....3-43
  - following .....3-48
  - inserting waypoint from plotter display.....3-42
  - inserting waypoint from route list .....3-41
  - removing waypoint from.....3-43
  - switching waypoints in route navigation....3-50
  - voyage based.....3-38
- S**
- SART .....2-48
- Satellite disable (GPS Receiver GP-310B) ..5-24
- SAVE DATA menu.....6-1
- SAVE/MOB key.....1-14
- Second-track echoes (radar) .....2-32
- Sensor setup.....5-29
- SENSOR SETUP menu.....5-30
- SENSOR SETUP soft key .....5-29
- Shadow sectors .....2-47
- Shift
  - automatic (radar) .....2-20
  - manual (radar) .....2-19
  - sounder .....4-11
- SHIFT soft key .....2-19, 4-11
- Sidelobe echoes .....2-46
- Signal level erasure (sounder).....4-15
- SIM SETUP menu.....1-18
- Simulation display.....1-18
- Smoothing echoes (sounder).....5-29
- SNDR CNTRL soft key .....1-11
- Soft keys .....1-3
- Speed alarm.....3-55
- Speed averaging
  - GPS Receiver GP-310B) .....5-23
  - navigator (GPS, Loran C) .....5-21
- Speed display.....5-2
- Speed/course smoothing (GPS Receiver GP-310B).....5-23
- SPLIT soft key.....4-8
- System configuration ..... x
- SYSTEM SETUP menu (sounder).....5-28
- T**
- TARGET INFO soft key.....2-41
- TARGET soft key .....2-23
- TD display .....5-2
- TD setup
  - Decca.....5-26
  - Loran C .....5-25
- TD SETUP menu .....5-25
- Test menu .....7-6
- Test pattern .....7-9
- Time measurement (sounder) .....4-12
- Time notation .....5-2
- TLL data output (radar) .....2-28
- TLL OUTPUT key .....2-28



- Track
- displaying other targets' .....3-19
  - displaying own ship's .....3-18
  - erasing all own ship's .....3-24
  - erasing all targets' .....3-24
  - erasing own ship's by area .....3-23
  - erasing own ship's by color .....3-24
  - memory distribution setting .....3-22
  - plotting interval .....3-21
  - plotting method .....3-21
  - plotting of own ship's .....3-19
- TRACK HALT soft key .....3-19
- TRACK RESUME soft key .....3-19
- Trackball
- cleaning .....7-2
  - operation .....1-13
- TRAIL COLOR soft key .....2-25
- TRAIL ON/OFF soft key .....2-24
- TRAIL soft key .....2-23
- TRAIL TIME soft key .....2-23
- Trip alarm .....3-56
- Trip distance resetting .....3-60
- Troubleshooting
- general .....7-3
  - plotter .....7-4
  - radar .....7-3
  - sounder .....7-5
- True motion mode .....2-10
- Tuning .....2-2
- TVG .....5-29
- Tx sector (radar) .....5-4
- U**
- Uploading data .....6-5
- V**
- Vector (ARP) .....2-39
- Virtual image .....2-47
- VRM (Variable Range Marker)
- radar .....2-13
  - sounder .....4-12
- VRM soft key .....2-14, 2-15
- W**
- WAAS .....5-25
- W. MAN soft key .....2-31
- Watchman .....2-31
- Water temperature alarm .....4-23
- Water temperature graph .....4-25
- Water temperature unit .....5-2
- Waypoint marker (radar) .....2-33
- Waypoints
- changing size .....3-34
  - color .....3-29
  - editing from waypoint list .....3-31
  - editing waypoint position .....3-32
  - editing with cursor .....3-31
  - entering at own ship position .....3-28
  - entering by range and bearing .....3-30
  - entering with cursor .....3-28
  - erasing from the menu .....3-33
  - erasing from waypoint list .....3-33
  - erasing with cursor .....3-33
  - loading from Yeoman .....6-8
  - navigating to .....3-45
  - searching .....3-35
  - shape .....3-29
  - switching in route navigation .....3-50
- White marker .....4-16
- World time chart .....11
- WPT MK soft key .....2-33
- X**
- XTE (cross track error) alarm .....3-55
- XTE monitor .....3-4, 3-5
- Y**
- Yeoman .....6-8
- Z**
- Zero line .....4-26
- Zoom .....2-18
- ZOOM/D. BOX soft key .....2-18

# FURUNO

**FURUNO ELECTRIC CO., LTD.**

9-52 Ashihara-Cho, Nishinomiya City, 662-8580, Hyogo, Japan

Tel: +81 798-65-2111 Fax: +81 798-65-4200

Pub NO. DOC-389

## Declaration of Conformity 0560

We FURUNO ELECTRIC CO., LTD.

(Manufacturer)

9-52 Ashihara-Cho, Nishinomiya City, 662-8580, Hyogo, Japan

(Address)

declare under our sole responsibility that the product

10.4" colour LCD radar Models 1833C (ø602 mm radome, 4 kW, 24 rpm), 1933C (1035 mm open, 4 kW, 24/48 rpm) and 1943C (1255 mm open, 6 kW, 24/48 rpm) with optional GPS receiver GP-310B for recreational crafts; the LCD is available in two versions: brightness level 300 cd/m<sup>2</sup> or 700 cd/m<sup>2</sup>

(Model name, type number(s))

are in conformity with the essential requirements as described in the Directive 1999/5/EC of the European Parliament and of the Council of 9 March 1999 on radio equipment and telecommunications terminal equipment (R&TTE Directive) and satisfies all the technical regulations applicable to the product within this Directive

EN 60945: 1997-01 (IEC 60945 Third edition: 1996-11)

KSR 142: October 1985, Annex 1

ITU-RR. App. S3: ed. 1998, Appendix S3, table 2

(title and/or number and date of issue of the standard(s) or other normative document(s))

For assessment, see

- Statement of Opinion N° 01214052/AA/00 of 27 March 2001 issued by KTL Certification, The Netherlands
- Test reports FLI 12-00-017, FLI 12-01-018, FLI 12-01-019, FLI 12-01-004, FLI 12-01-005, FLI 12-01-006, FLI 12-01-015, FLI-12-01-028 prepared by Furuno Labotech International Co., Ltd., Japan

On behalf of Furuno Electric Co., Ltd.

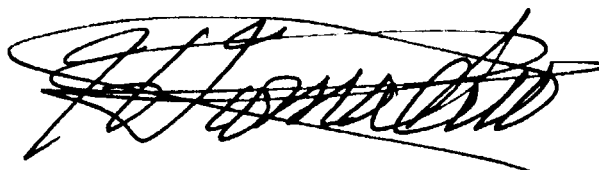

Hiroaki Komatsu  
Manager,  
International Rules and Regulations

Nishinomiya City, Japan  
May 25, 2001

(Place and date of issue)

(name and signature or equivalent marking of authorized person)

# FURUNO®

**FURUNO ELECTRIC CO., LTD.**

9-52 Ashihara-Cho, Nishinomiya City, 662-8580, Hyogo, Japan  
Tel: +81 798-65-2111 Fax: +81 798-65-4200

Pub NO. DOC-480

## Declaration of Conformity



We FURUNO ELECTRIC CO., LTD.

(Manufacturer)

9-52 Ashihara-Cho, Nishinomiya City, 662-8580, Hyogo, Japan

(Address)

declare under our sole responsibility that the product

Marine radar Model 1953C

(Model name, serial number)

is in conformity with the essential requirements as described in the Directive 1999/5/EC of the European Parliament and of the Council of 9 March 1999 on radio equipment and telecommunications terminal equipment (R&TTE Directive) and satisfies all the technical regulations applicable to the product within this Directive

EN 60945: 1997-01 (IEC 60945 Third edition: 1996-11)

EN 60950: 2000 (IEC 60950 Third edition: 1999-04)

KSR 142, Annex 1

(title and/or number and date of issue of the standard(s) or other normative document(s))

For assessment, see

- Statement of Opinion N° 02214128/AA/00 of 3 July 2002 issued by Telefication, The Netherlands
- KSR 142 Test Report FLI 12-02-007 of 10 April 2002, EMC Test Report FLI 12-02-014 of 10 April 2002 and Safety Test Report FLI 12-02-015 of 4 June 2002 prepared by Furuno Labotech International Co., Ltd.

On behalf of Furuno Electric Co., Ltd.

Hiroaki Komatsu

Manager,

International Rules and Regulations

Nishinomiya City, Japan

July 26, 2002

(Place and date of issue)

(name and signature or equivalent marking of authorized person)

**FURUNO****FURUNO ELECTRIC CO., LTD.**

9-52 Ashihara-Cho, Nishinomiya City, 662-8580, Hyogo, Japan

Tel: +81 798-65-2111 Fax: +81 798-65-4200

Pub NO. DOC-500

**Declaration of Conformity**We **FURUNO ELECTRIC CO., LTD.**

(Manufacturer)

9-52 Ashihara-Cho, Nishinomiya City, 662-8580, Hyogo, Japan

(Address)

declare under our sole responsibility that the product

**Marine radar Model 1823C**

(Model name, serial number)

is in conformity with the essential requirements as described in the Directive 1999/5/EC of the European Parliament and of the Council of 9 March 1999 on radio equipment and telecommunications terminal equipment (R&TTE Directive) and satisfies all the technical regulations applicable to the product within this Directive

EN 60945: 1997-01 (IEC 60945 Third edition: 1996-11)

EN 60950: 2000 (IEC 60950 Third edition: 1999-04)

KSR 142: 1985-10, Annex 1

ITU Radio Regulations App. S3: 1998, Appendix S3, table 2

(title and/or number and date of issue of the standard(s) or other normative document(s))

For assessment, see

- Statement of Opinion N° 02214271/AA/00 of 6 December 2002 issued by Telefication, The Netherlands
- Test Report FLI 12-02-042 of 06 September 2002, EMC Test Report FLI 12-02-043 of 25 November 2002 and Safety Test Report FLI 12-02-053 of 26 November 2002 prepared by Furuno Labotech International Co., Ltd.

On behalf of Furuno Electric Co., Ltd.

Hiroaki Komatsu  
Manager,  
International Rules and Regulations

Nishinomiya City, Japan

January 10, 2003

(Place and date of issue)

(name and signature or equivalent marking of authorized person)