

FURUNO

OPERATOR'S MANUAL

15" MULTI-COLOR HIGH-PERFORMANCE
SHIPBORNE RADAR AND ARPA

MODEL FR-1500 MARK-3 SERIES



FURUNO ELECTRIC CO., LTD.
NISHINOMIYA, JAPAN



(Elemental Chlorine Free)

The paper used in this manual
is elemental chlorine free.

© **FURUNO ELECTRIC CO., LTD.**

9-52 Ashihara-cho,
Nishinomiya 662-8580, JAPAN

Telephone : 0798-65-2111

Fax : 0798-65-4200

FURUNO Authorized Distributor/Dealer

All rights reserved.

Printed in Japan

Pub. No. OME-34500

(TATA) FR-1500 MARK-3 SER.

FIRST EDITION : OCT. 1998

V7 : APR. 21, 2005



* 0 0 0 8 0 8 4 0 4 1 1 *



* O M E 3 4 5 0 0 V 7 0 *

SAFETY INSTRUCTIONS



DANGER

Before turning on the radar/ARPA, make sure that there is not one near the antenna unit. Serious injury or even death may result if a rotating antenna strikes someone standing nearby.



WARNING

Radio frequency Radiation Hazard

The radar antenna emits electromagnetic radio frequency (RF) energy, which can be harmful, particularly to your eyes. Never look directly into the antenna aperture from a close distance while the radar is in operation or expose yourself to the transmitting antenna at a close distance.

SOFTWARE PROGRAM NO.

Model	Software (Prog No.)	Date
FR-1500 MARK-3	0359152109	March 00
	0359152110	Dec.01
	0359152111	June 04
ATA	1859041102	June 99
	1859042101	June 99
RP-17	0359155103	March 00
RP-180	0359219-01	June 04
	0359220-01	

For your safety:



WARNING

Do not open the equipment

Hazardous voltage which can cause electrical shock exists inside the equipment. Only qualified personnel should work inside the equipment.



Turn off the radar power switch before servicing the antenna unit. Post a warning sign near the switch indicating it should not be turned on while the antenna unit is being serviced.

Prevent the potential risk of being struck by the rotating antenna and exposure to RF radiation hazard.



Wear a safety belt and hard hat when working on the antenna unit.

Severe injury or death can result if someone falls from the radar antenna mast.

Do not disassemble or modify the equipment.

Fire, electrical shock or serious injury can result.

Turn off the power immediately if water leaks into the equipment or the equipment is emitting smoke or fire.

Continued use of the equipment can cause fire or electrical shock.



WARNING

Do not place liquid-filled containers on the top of the equipment.

Fire or electrical shock can result if a liquid spills into the equipment.

Do not operate the equipment with wet hands.

Electrical shock can result.

Keep heater away from equipment

Heat can alter equipment shape and melt the power cord, which can cause fire or electrical shock.



CAUTION

Do not use the equipment for other than its intended purpose.

Use of the equipment as a stepping stool, for example, can result in personal injury or equipment damage.

Replace the monitor when the picture becomes difficult to see.

The average life of the monitor screen is about 10 years. Replace it when the picture becomes difficult to see.

A warning label is attached to the equipment. Do not remove the label. If the label becomes soiled or illegible, contact a Furuno agent or dealer.

No one navigation device should be solely relied on for navigation of a ship.

Always confirm position against all available aids to navigation, for safety of ship and crew.

Compliance with MED and R&TTE Directive

This radar complies with MED 96/98/EC and its amendment 2002/75/EC of September 2, 2002 and also complies with the R&TTE Directive 1999/5/EC. In accordance with Article 6-3 of the above-mentioned R&TTE directive, FURUNO intends to put this radar on the market of the following countries in EU as well other markets.

Austria, Belgium, Cyprus, Denmark, Estonia, Finland, France, Germany, Greece, Hungary, Ireland, Italy, Latvia, Lithuania, Malta, Poland, Portugal, Slovenia, Spain, Sweden, The Netherlands, United Kingdom, Iceland, Norway

TABLE OF CONTENTS

INTRODUCTION	vi
Specifications of FR-1500 Mark-3 Series shipborne radar	ix
1 OPERATIONAL OVERVIEW	1.1
1.1 Turning on the Power	1
1.2 Transmitter ON.....	1
1.3 Control Description	2
1.4 CRT Brilliance	3
1.5 Control Panel Backlighting.....	3
1.6 Tuning the Receiver.....	3
1.7 Degaussing the Screen	4
1.8 Initializing the Compass Readout.....	4
1.9 Entering Own Ship's Speed	5
1.10 On-screen Legends and Markers	6
1.11 Presentation Modes.....	7
1.12 Selecting the Range Scale.....	10
1.13 Selecting the Pulselength	10
1.14 Adjusting the Sensitivity.....	11
1.15 Suppressing Sea Clutter	11
1.16 Suppressing Precipitation Clutter	12
1.17 Interference Rejector	12
1.18 Measuring the Range	13
1.19 Measuring Bearing.....	14
1.20 Collision Assessment by the Offset EBL	14
1.21 Measuring Range and Bearing Between Two Targets.....	16
1.22 Setting a Target Alarm Zone	17
1.23 Off-centering (shift).....	18
1.24 Echo Averaging	19
1.25 Electronic Plotting Aid (EPA).....	21
1.26 Target Trails (Echo Trails).....	24
1.27 Parallel Index Lines	27
1.28 Reference Mark (not available with Video Plotter RP-17 or RP-180).....	27
1.29 Zoom (R-type only).....	28
1.30 Markers	29
1.31 Suppressing Second-trace Echoes	30
1.32 [F1] Key.....	30
1.33 [F2] Key.....	31
1.34 FUNCTION Key.....	32
1.35 Adjusting Brilliance of Screen Data	34
1.36 Echo Stretch, Contrast, Enhanced Video	35
1.37 Watch Timer.....	36
1.38 Noise Rejector.....	37
1.39 Navigation Data.....	37
1.40 Alarm Output (R-type only)	37
1.41 Outputting Target Position (R-type only)	37
1.42 Degaussing Interval.....	38
1.43 Background Color.....	38
1.44 Clutter Sweep.....	38
1.45 Day, Night Brilliance	39
1.46 Contrast.....	39
1.47 Radar Map (RP-17 or RP-180 required).....	40
1.48 Alarms.....	44
1.49 Enlarging Close-in Targets (R-type only).....	46
1.50 A/D Converter Curve Setting (R-type only).....	46
1.51 Echo Area (R-type only).....	47

1.52	Real Time Heading Up (R-type only).....	47
2	OPERATION OF AUTOMATIC TRACKING AID (ATA) ARP-17	2.1
2.1	Introduction	1
2.2	Criteria of Tracking	2
2.3	Activating, Deactivating the ATA	4
2.4	Entering Own Ship's Speed	5
2.5	Acquiring Targets	6
2.6	Terminating Tracking of Targets	8
2.7	Vectors True or Relative	9
2.8	Displaying Target Data	9
2.9	Past Position Display	10
2.10	Set and Drift	10
2.11	Alarms	11
2.12	Track Test (Simulation Display)	13
2.13	Outputting Target Data	13
2.14	Diagnostic Sequence.....	14
2.15	Factors Affecting ARPA Functions	15
3	RADAR OBSERVATION.....	3.1
3.1	General	1
3.2	False Echoes.....	2
3.3	SART (Search and Rescue Transponder).....	4
3.4	RACON (Radar Beacon).....	6
4	OPERATION OF VIDEO PLOTTER RP-17 (OPTION).....	4.1
5	MAINTENANCE.....	5.1
5.1	Periodic Maintenance Schedule.....	1
5.2	Life Expectancy of Major Parts	2
5.3	Replacement of Batteries.....	2
6	TROUBLESHOOTING	6.1
6.1	Easy Troubleshooting	1
6.2	Advanced-level Troubleshooting	2
6.3	Diagnostic Test.....	6
6.4	Menu Hierarchy	8
7	OPTIONAL EQUIPMENT	7.1
7.1	Performance Monitor (Option).....	1
8	DIGITAL INTERFACE (IEC 61162-1 Edition 1 and 2))	8.1
	Description of Sentences.....	3
9	PARTS LOCATION and PARTS LIST	9.1
9.1	ANTENNA UNIT, SCANNER OUTLINE and RF MODULE	1
9.2	Circuit diagrams.....	5
9.3	Parts list	8
	Declaration of conformity to type	

INTRODUCTION

Word to the Owner of FURUNO Radar

Thank you for purchasing this FURUNO radar. We are confident you will discover why FURUNO has become synonymous with quality and reliability.

Dedicated in the design and manufacture of marine electronics equipment for half a century, FURUNO Electric Company has gained an unrivaled reputation as a world leader in the industry. This is the result of our technical excellence as well as our worldwide distribution and service network.

Please carefully read and follow the safety information and operating and maintenance instructions set forth in this manual before attempting to operate the equipment and conduct any maintenance. Your radar set will perform to the utmost of its ability only if it is operated and maintained in accordance with the correct procedures.

Features of This Series of Radars

- Daylight-bright rasterscan 15-inch multi-color, high-resolution display
- New microprocessing technology with high-speed high-density gate array and software expertise
- New cast aluminum scanner gearbox and new series of radiators
- Easy operation by combination of discrete keys, rotary controls, and menu operation, all logically arranged and configured
- Electronic Plotting Aid (EPA) fitted standard, Automatic Tracking Aid (ATA) option exceeding IMO and IEC standards
- Reliable CPA and TCPA warning in any plotting mode, accurate target data
- Stand-alone or integrated configuration
- Meets the current and future IMO and IEC standards as a shipborne radar. New radar standard MSC.64(67) Annex 4 must be met for new installation on and after January 1, 1999

FR-1500 Mark-3 Series of Radars

This Series of FURUNO radars are designed to meet various customers' needs and the exacting requirements of international and national standards and regulations including:

- IMO A.477(XII): Performance Standards for Radar Equipment (up to 31.12.1998)
- IMO MSC.64(67) Annex 4: Performance Standards for Radar Equipment (1.1.1999 and after)
- IEC 60936-1: Shipborne Radar Operational and Performance Requirement (1.1.1999 and after)
- IEC 60872-2: Automatic Tracking Aids (ATA)
- IEC 60945: 1996-11(3rd Ed) Marine Navigational Equipment General Requirements

Models

This series of radar and ARPA is available in the following models:

FR-1505 MARK-3	X-band 6 kW
FR-1510 MARK-3	X-band 12 kW
FR-1525 MARK-3	X-band 25 kW

All come with the EPA (Electronic Plotting Aid) fitted standard. An option is available to provide the full functionality of ATA (Automatic Tracking Aid). A Video Plotter (Chart Plotter), which provides Radar Map functions, and Performance Monitor are also optionally available.

The FR-1500 MARK-3 Series is available in the **Regular type** (R-type) and **IMO type**. The R-type satisfies the IMO and IEC standards but includes more flexibility of functionality. These radars comply with the carriage requirements on the relevant type of ships of the 1974 SOLAS Convention.

The table below shows the differences between R-type and IMO-type radars. Other functions and specifications are common. The operator cannot navigate between the two types.

Function	IMO type	Regular type (R-type)
Range scales	0.125, 0.25, 0.5, 0.75, 1.5, 3, 6, 12, 24, 48, 96 nm	0.125, 0.25, 0.5, 0.75, 1.5, 3, 6, 12, 24, 48, 72, 96 nm (sm, km on menu)
Target Alarm zones	Radar: 2 Target Alarm Zones. NO. 1 TAZ: between 3 and 6 nm in 0.5 nm depth, NO. 2: anywhere when NO. 1 is valid. ATA: One Guard Zone: Default GZ covers 3.5-4 nm, adjustable between 3 and 6 nm, in 0.5 nm range depth.	Radar: Target Alarm Zone: 1 st and 2 nd TAZs anywhere. Alarm can be selected for inside (as TAZ) or outside (as off-zone Anchor Watch). ATA: One Guard Zone: Anywhere
x2 Zoom	Not available	Available on menu
Echo colors	Monochrome yellow or green in 16 tones	Choice of monochrome in 16 tones or 3 colors depending on echo strengths
Speed mode	Manual, Log	Manual, Log, and NAV (GPS, DGPS)
Target trail intensity	Not available	1, 2, 3, 4
Close-in range enhancement	Not available	CENter ENHANCE on menu
A/D curve	Not available	A, B, C, D

When the gyrocompass or magnetic compass is not connected to IMO type radar, the functions mentioned below are inoperative.

In this case, the HDG SNSR on the SET UP 2 menu of the Installation menu should be set to OFF. (See page 5-7 in the installation manual.)

1. Alert and indication for heading sensor do not appear on the screen and also the indication of HDG does not appear on the screen.
2. The PLOT on the main menu is not accessible. Therefore, the menus of EPA and ATA are not accessible.
3. On the menu of "FUNC1 SET", "FUNC2 SET" and "FUNC3 SET", the ECHO AVG is not available. However, echo averaging can be turned on without gyrocompass connection by setting ECHO AVG ON on the OTHER menu of the Installation menu.
4. On the F.2 MENU, the following are inoperative.
 2. TRAIL MODE
 15. PLOT MENU
 16. MARK MODE
 18. DRIFT MENU
 26. EXT WP
 30. EBL/+/PI
5. MODE on the TGT TRAIL menu is not accessible. The mode of target trail is always relative.
6. SET & DRIFT on the OTHER menu is not accessible.
7. DEGS DEG on the DEGAUSS menu is not accessible.
8. EXT WPT on the NAV DATA menu is not accessible.
9. The MODE key is not accessible. The display mode is fixed to heading-up mode.
10. EBL/+/PI on the EBL/VRM/+ menu is not accessible.
11. HDG SET on the OTHERS menu is not accessible.
12. The cursor position (Lat./Long.) is not displayed but range and bearing from own ship to the cursor are displayed.
13. VECTOR T/R and ECHO AVG on the F.1 menu are not accessible.
14. MODE on the MARK menu is not accessible. The mark mode is always relative.
15. RP-17 and ARP-17 are not available.

Specifications of FR-1500 Mark-3 Series shipborne radar

ANTENNA RADIATORS

1. Type: Slotted waveguide array
2. Beamwidth:
 - Radiator type: XN12AF XN20AF XN24AF
 - Length: 4 ft 6.5 ft 8 ft
 - Beamwidth(H): 1.8° 1.23° 0.95°
 - Beamwidth(V): 20° 20° 20°
 - Sidelobe $\pm 10^\circ$: -28 dB (all radiators)
 - Polarization: Horizontal (all radiators)
3. Rotation: 24 rpm or 42 rpm
Note: 42 rpm is not available in 12 VDC system

RF TRANSCEIVER

1. Frequency: 9410 MHz ± 30 MHz (X-band)
2. Output power:
 - FR-1505M3: 6 kW
 - FR-1510M3: 12 kW
 - FR-1525M3: 25 kW
3. Range, Pulselength (PL) & PRF

Range scales	P/L (μ s)	PRF (Hz)
0.125, 0.25	0.07	3000
0.5	0.07/0.15	3000
0.75, 1.5	2 from 0.07/0.15/0.3	3000/1500
3	2 from 0.07.15/0.3/0.5/0.7	3000/1500
6, 12	2 from 0.3/0.5/0.7/1.2	1500/1000
24	2 from 0.5/0.7/1.2	1000/600
48, 96	1.2	600

4. IF: 60 MHz, Logarithmic. BW 28/3 MHz
5. Noise figure: 6 dB
6. Duplexer: Ferrite circulator with diode limiter

DISPLAY UNIT

1. Picture tube: 15" color CRT, effective diameter: 185 mm. Yellow or green echoes in 16 levels. Rasterscan non-interlace at 48.3 kHz hor, 60 Hz vert. R-type has yellow or green monochrome plus 3 color display with echo strengths.
2. Minimum range and range discrimination: 35 m
3. Range scales: 0.125, 0.25, 0.5, 0.75, 1.5, 3, 6, 12, 24, 48, 96 nm
4. Range accuracy: 1 % of the maximum range of the scale in use, or 30 m, whichever is the greater.
5. Bearing discrimination: Better than 2.5°
6. Bearing accuracy: $\pm 1^\circ$
7. Presentation: Head-up, Head-up TB, North-up, Course-up, TM sea or ground stabilization

8. Plotting facilities:

- EPA: 10 targets manual plot, automatic follow-up. Warning if not plotted within 10 min. Disabled when ATA board ARP-17 is accommodated.
- ATA: Automatic tracking for up to 20 targets (10 manually acquired plus 10 auto acquired, or 20 manually acquired). Complies with IMO MSC.64(67) Annex 4 and IEC 60872-2. Needs ARP-17 optionally.
- Common feature: Sea and ground stabilized Vectors and target trails

9. Radar map: Nav lines, coastlines, buoys, etc. produced by operator. 3000 pts in Radar mode, 6000 pts on IC card in Chart mode. Needs RP-17 Board to meet MSC.64(67) Annex 4.

10. Target Alarm Zone: TAZ: Two Target Alarm Zones
One GZ (ATA): Default 3.5-4.0 nm, $\pm 45^\circ$ of heading line (bow)

11. Parallel Index Line: Choice of 2 or 6 lines

INTERFACE

1. IEC 61162-1: RSD, TTM, etc.
2. Gyrocompass: Built-in interface (option) for sync signal (20-135 V, 50-400 Hz), or stepper signal (20-135 VDC), any polarity
3. Speed log: IEC 61162-1, contact closure or 200/400/500 pulses/nm

POWER SUPPLY

DC power

- FR-1505 MARK-3: 24 rpm: 12/24-32 VDC, 15.4/7.1-5.3 A (19.6/9.2-6.9 A)
42 rpm: 24-32 VDC, 7.5-5.6 A (10.4-7.8 A)
- FR-1510 MARK-3: 24 rpm: 12/24-32 VDC, 17.5/8.3-6.3 A (22.0/10.2-7.7 A)
42 rpm: 24-32 VDC, 8.8-6.6 A (11.5-8.6 A)
- FR-1525 MARK-3: 24 rpm: 24-32 VDC, 9.2-6.9/11.0-8.3 A
42 rpm: 24-32 VDC, 9.6-7.2 A (12.3-9.2 A)

AC power (100/110/115 or 220/230 VAC, 1 ϕ , 50-60 Hz)

- FR-1505 MARK-3: : (24/42 rpm): 2.7/2.9 (3.5/3.9) A at 100 V
- FR-1515 MARK-3: : (24/42 rpm): 3.1/3.3 (3.9/4.4) A at 100 V
- FR-1525 MARK-3: : (24/42 rpm): 3.4/3.6 (4.2/4.7) A at 100 V

(): at wind speed 100 kt

ENVIRONMENTAL CONDITIONS

- Ambient temperature (Complies with IEC 60945)
 - Display unit: -15 to +55°C
 - Antenna unit: -25 to +70°C (Storage)
- Relative humidity: 93% at 40°C

EQUIPMENT LIST

Standard

- Display unit RDP-119 (AC or DC)
- Scanner unit RSB-0074 (24 rpm), -0075 (42 rpm) with RF transceiver unit RTR-067 (6 kW), -062 (12 kW), -063 (25 kW)
- Antenna radiator
 - XN-12AF (4 ft), -20AF (6.5 ft), -24AF (8 ft)
- Antenna cable 15/20/25/30m (Specify)

COATING COLOR

- Display Unit: Panel: N3.0 (Dark grey)
Cover: 2.5GY5/1.5 (Light grey)
- Antenna Unit: N9.5 (White)

Option

- Power cable CVV-S8x2C 15 m (for DC set)
- Stepdown transformer RU-1803 (440 V, 1 ϕ)
- Rectifier RU-1746B-2 (115/230 V to 24 VDC)
- Rectifier RU-3424 (115/230 V to 24 VDC for 25 kW, 42 rpm)
- 42 rpm scanner motor
- ARPA board ARP-17
- Video plotter board RP-17 or RP-180 (Mandatory on IMO-type)
- ROM card (for digital charts), RAM card (for custom data) for RP-17 expanded radar map
- Sub display FMD-8001 (R-type)

Electromagnetic radiofrequency radiation

MODEL	RADIATOR TYPE	Distance to 100 W/cm ²	Distance to 10 W/cm ²	RF power density on antenna aperture
FR-1505 M3 (X, 6 kW)	XN12AF (4')	none	2.1 m	75 W/cm ²
	XN20AF (6.5')			
FR-1510 M3 (X, 12 kW)	XN12AF (4')	1.1 m worst case	10.0 m worst case	200 W/cm ² worst case
	XN20AF (6.5')			
FR-1525 M3 (X, 25 kW)	XN20AF (6.5')	1.1 m worst case	10.0 m worst case	200 W/cm ² worst case

Category of Equipment Units

Equipment for Protected Area	Equipment for Exposed Area
Display unit Power supply unit Interswitch unit	Antenna unit (Scanner unit, RF Transceiver unit) Performance monitor

Compass safe distance

Equipment unit	Standard compass	Steering compass	Remarks
Display unit RDP-119	0.80 (0.50) m	0.50 (0.30) m	
Antenna unit RTR-067 (6 kW)	1.40 (0.85) m	0.70 (0.45) m	For all radiators
Antenna unit RTR-062 (12 kW)	1.70 (1.05) m	0.90 (0.55) m	For all radiators
Antenna unit RTR-063 (25 kW)	2.10 (1.30) m	1.20 (0.75) m	For all radiators
RF Transceiver unit			
Performance monitor PM-30 (X-band)	0.4 m	0.3 m	

Measurements by the BSH, Germany, Cert Nr. 287/2. Figures in () apply to the coastal boats under German Regulations.

CONFIGURATION OF FR-1500 MARK-3 SERIES RADARS

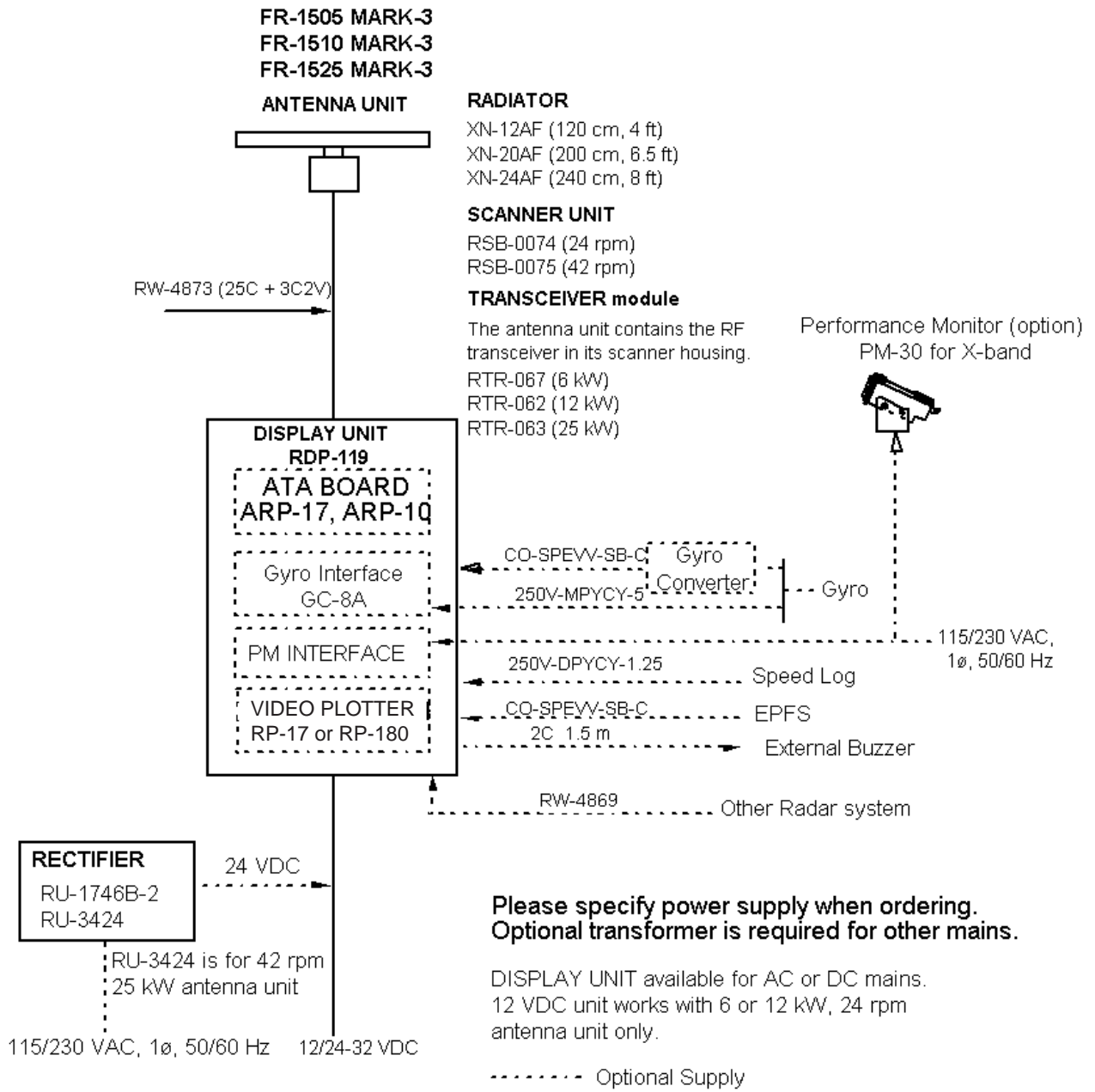

This page is intentionally left blank.

1 OPERATIONAL OVERVIEW

1.1 Turning on the Power

The [POWER] switch is located at the left corner of the display unit. Push it to switch on the radar set. To turn off the radar, push it again. The screen shows the bearing scale and digital timer approximately 15 seconds after power-on. The timer counts down three minutes of warm-up time. During this period the magnetron, that is, the transmitter tube, is warmed for transmission. When the timer has reached 0:00, the indication STBY appears, indicating that the radar is now ready to transmit pulses.

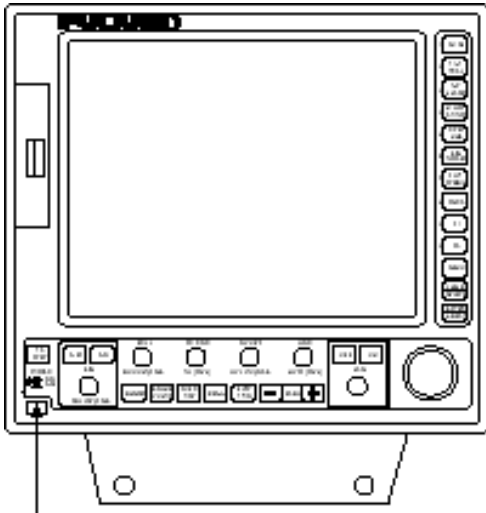

POWER
switch

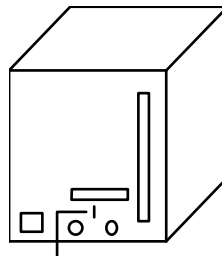

Switch S2

Notice for technicians

The display unit designed to run on AC voltage has a switch (S2) at its rear to cut off 115/230 V supply from internal circuits. Thus, the radar will not operate when this switch is turned off. Keep it in the ON position.

1.2 Transmitter ON

After the power is turned on and the magnetron has warmed up, STBY appears at the screen center, indicating the radar is ready to transmit radar pulses. Press the [STBY/TX] key to transmit. When you won't be using the radar for an extended period, but you want to keep it in a state of readiness, place it in standby by pressing the [STBY/TX] key. The display shows STBY.



Video Freeze-up Recovery

Video freeze-up or lock-up can occur unexpectedly on any digital rasterscan radars. This is mainly caused by heavy spike noise in the power line and can be noticed by carefully watching the nearly visible sweep line. If you suspect that the picture is not updated every scan of the antenna or no key entry is accepted notwithstanding the apparently normal pictures, do Quick Start to restore normal operation.

- .1 Turn off the Power Switch and within 10 seconds turn it on again.
- .2 Press the Transmit switch labeled STBY/TX for transmit condition.

1.3 Control Description

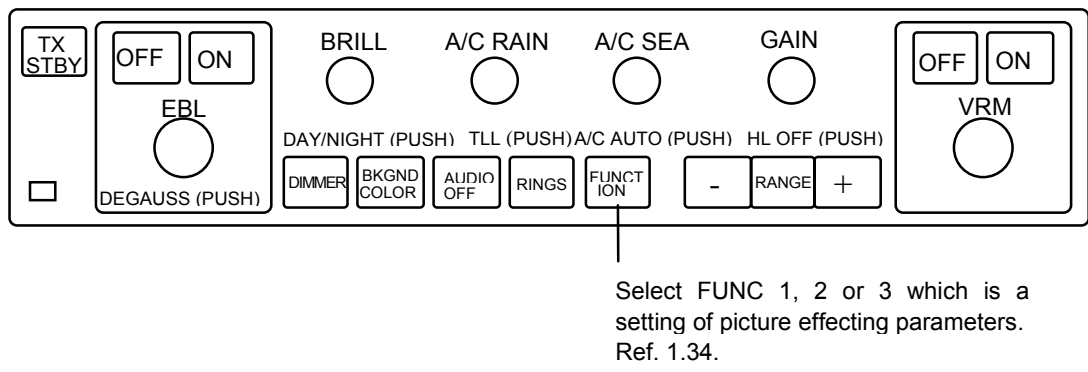
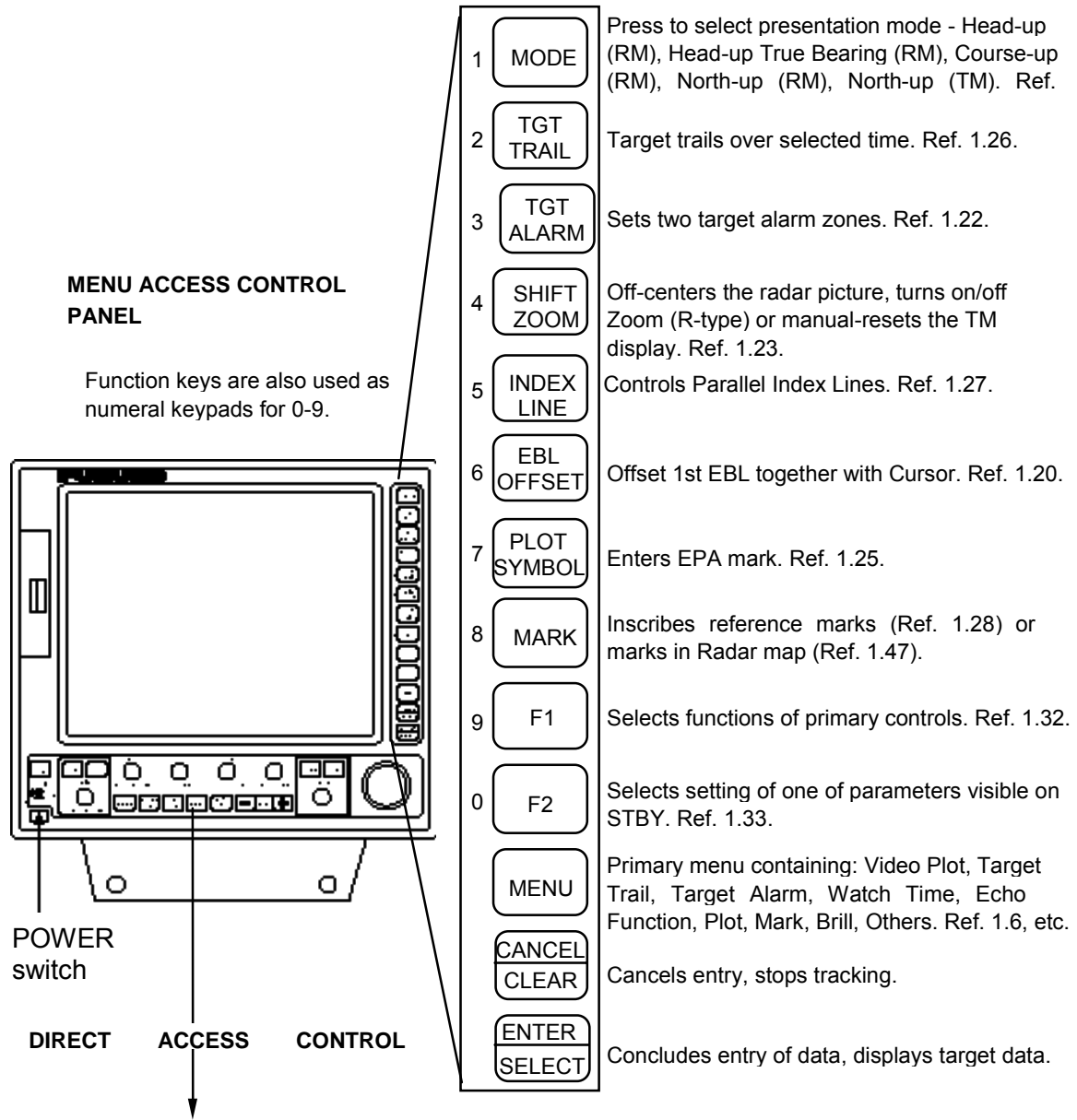

TLL: Target Latitude/Longitude outputted in IEC 61162-1 format.

1.4 CRT Brilliance

Operate the BRILL control on the control panel of the display unit to adjust the entire screen brightness. Note that the optimum point of adjustment varies with ambient lighting conditions, especially between daytime and nighttime.

1.5 Control Panel Backlighting

Operate the [DIMMER] key to adjust control panel backlighting.

1.6 Tuning the Receiver

1.6.1 Automatic tuning

The radar is set for automatic tuning at the factory. The radar receiver is tuned automatically each time the power is turned on. The tuning indicator and the label AUTO at the top right corner of the display unit show the tuning circuit is working. The receiver may become detuned, in automatic tuning, if own ship's radar receives the radar signal of another shipborne radar. To return, press the [STBY/TX] key twice.

1.6.2 Manual tuning

Press the GAIN control (Push for HL OFF) and adjust the VRM control after setting as below:

1. Press the [MENU] key.

MENU	
1.	VIDEO PLOT*/AIS
2.	TGT TRAIL
3.	TGT ALARM
4.	WATCH TIME
5.	ECHO SIG
6.	FUNC
7.	PLOT
8.	MARK
9.	BRILL
0.	OTHERS

(a) Main menu

OTHERS	
1.	HDG SET
2.	SPD MODE MAN LOG
	LOG (S-BT)
	LOG (S-WT)
3.	MAN SPD
4.	SET & DRIFT
5.	DISPLAY
6.	MARK/LINE
7.	TUNE
8.	NAV DATA
9.	EBL/+/PI
0.	↓

(b) OTHERS menu

TUNE	
1.	↑
2.	MODE AUTO MAN

(c) TUNE menu

* Requires RP-17 or RP-180. AIS not shown on RP-17.

2. Press the [0] key twice to display the OTHERS menu. (b)
3. Press the [7] key to display the TUNE menu. (c)
4. Press the [2] key to select the option MAN from the MODE field.
5. Press the [ENTER/SELECT] key. While observing the picture on the 48-mile scale, slowly adjust the VRM rotary control while holding down the GAIN control to find the best tuning point. Make sure that the radar has been set to the best tuning point. This condition is where the tuning indicator lights to about 80% of its total length. Note that the tuning indication will never extend to full length.
6. Press the [MENU] key to close the menu.

1.7 Degaussing the Screen

Each time the radar is turned on, the degaussing circuit automatically demagnetizes the CRT screen to eliminate color contamination caused by earth's magnetism or magnetized ship structure.

The screen is also degaussed automatically at certain time intervals, which may be selected on the menu. While being degaussed, the screen may be disturbed momentarily with vertical lines. If you wish to degauss by manual operation, push the EBL rotary control.

1.8 Initializing the Compass Readout

With a compass interfaced with the radar, ship's heading is displayed at the top of the screen. Upon turning on the radar, match the on-screen HDG readout with the compass reading by the procedure shown below. Once you have set the initial heading correctly, resetting is not usually required. However, if the HDG readout goes wrong for some reason, repeat the procedure to correct it.

1. Press the [MENU] key to display the main menu.
2. Press the [0] key twice to display the OTHERS menu.

OTHERS	
1. HDG SET	
2. SPD MODE	MAN LOG
	LOG (S-BT)
	LOG (S-WT)
3. MAN SPD	
4. SET & DRIFT	
5. DISPLAY	
6. MARK/LINE	
7. TUNE	
8. NAV DATA	
9. EBL/+/PI	
0. ↓	

NAV is additionally available in R-type. If accuracy is doubtful, do not use the speed data obtained from GPS or DGPS.

3. Press the [1] key to select HDG SET.
4. Operate the VRM rotary control to duplicate the compass readout on the radar menu display.
5. Press the [ENTER/SELECT] key.
6. Press the [MENU] key to close the menu.

1.9 Entering Own Ship's Speed

EPA requires an own ship speed input and compass signal. The speed can be entered from a speed log (automatic) or through the plotting keypad (manual).

1.9.1 Automatic speed input

1. Press the [MENU] key and the [0] key twice to show the OTHERS menu.

OTHERS	
1. HDG SET	
2. SPD MODE	MAN LOG
	LOG (S-BT)
	LOG (S-WT)
3. MAN SPD	
4. SET & DRIFT	
5. DISPLAY	
6. MARK/LINE	
7. TUNE	
8. NAV DATA	
9. EBL/+/PI	
0. ↓	

NAV is additionally available in R-type. If accuracy is doubtful, do not use the speed data obtained from GPS or DGPS.

2. Press the [2] key to select the menu item SPD MODE.
3. Press the [2] key again to select the LOG option.
4. Press the [ENTER/SELECT] key to confirm your selection followed by the [MENU] key to close the menu. The ship's speed readout at the right-hand side of the screen shows own ship's speed fed from the speed log with the label LOG, BT or WT.

Notes:

- 1) IMO Resolution A.823(19) for ARPA recommends that a speed log to be interfaced with an ARPA should be capable of providing through-the-water speed. The same concept applies to the ATA and the EPA.
- 2) Be sure not to select LOG when a speed log is not connected. If the log signal is not provided, the ship's speed readout at the screen top will be blank.

1.9.2 Manual speed input

If the radar is not interfaced with a speed log, or the speed log does not feed correct speed enter the ship's speed as follows:

1. Press the [MENU] key and the [0] key twice to show the OTHERS menu.
2. Press the [2] key several times to select MAN from the SPD MODE field.
3. Press the [3] key to select the MAN SPD.
4. Enter speed with the numeric keys.
5. Press the [ENTER/SELECT] key to confirm your selection followed by the [MENU] key to close the menu. The ship's speed readout at the right-hand side of the screen shows own ship's speed fed from the speed log with the label MAN.

1.10 On-screen Legends and Markers

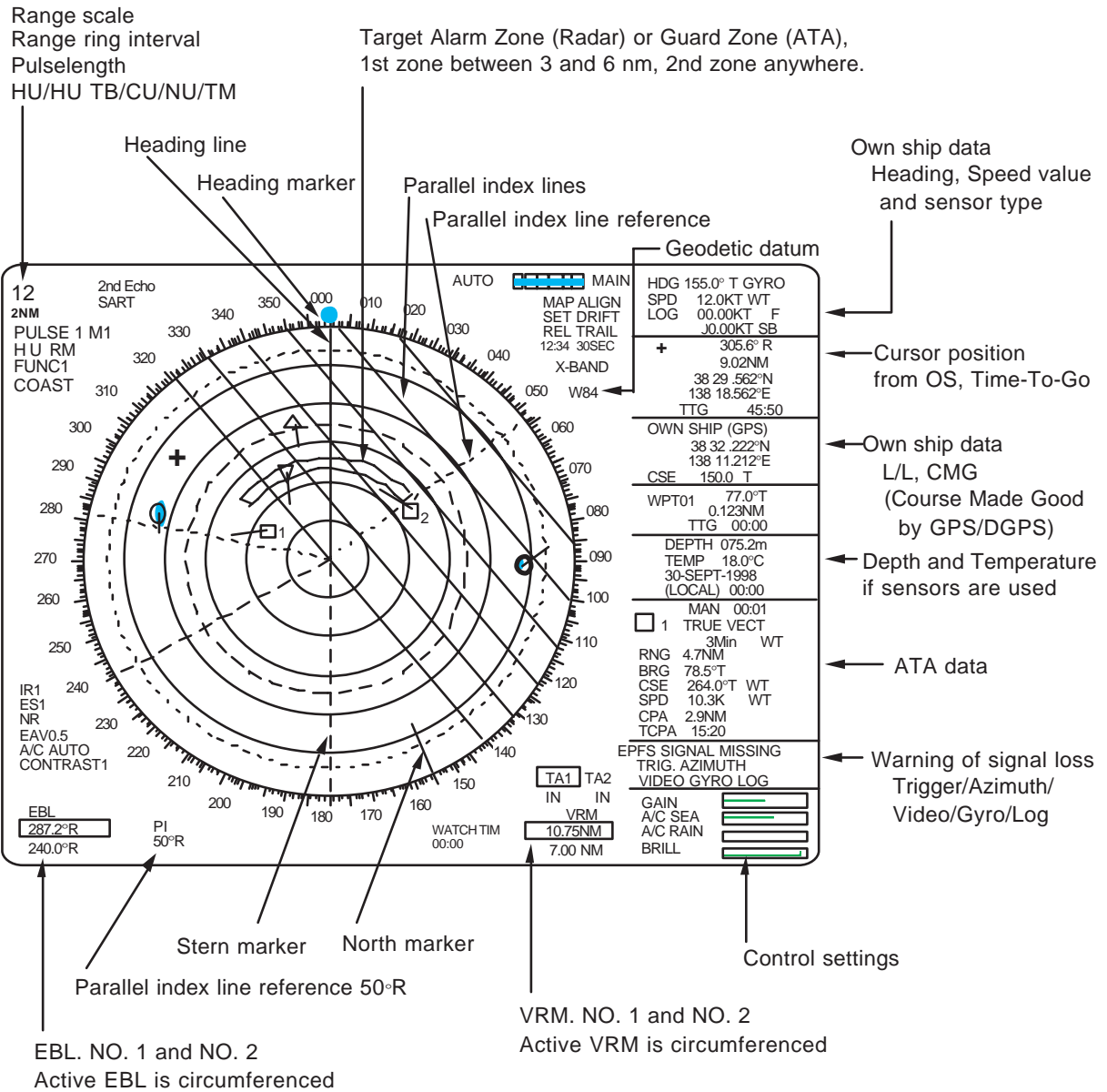

1.11 Presentation Modes

This radar has the following presentation modes: Head-up, Head-up/TB, Course-up, North-up, and True Motion.

1.11.1 Selecting presentation mode

Press the [MODE] key on the panel at the right side of the display unit. Each time the [MODE] key is pressed, the presentation mode and mode indication at the upper-left corner of the screen change cyclically.

Note: When a failure occurs in the gyrocompass, the radar will automatically be switched to unstabilized presentation mode. All compass related data will read Relative values.



Loss of Gyrocompass signal

When the compass signal is lost, the presentation mode automatically becomes head-up and the HDG (heading) readout at the top of the text area reads xxx.x°. Also GYRO SIGNAL MISSING appears in red at the lower right corner on the screen. Press the MODE key, and the x's go off. Then, match the on-screen HDG readout with the heading value.

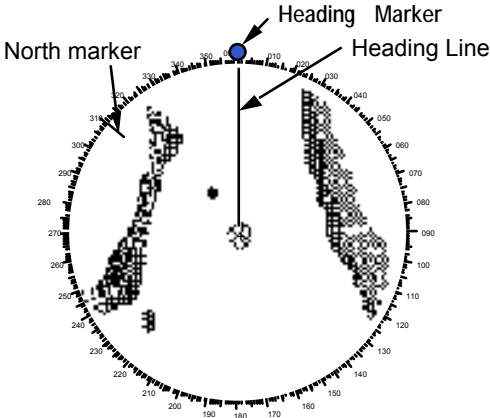
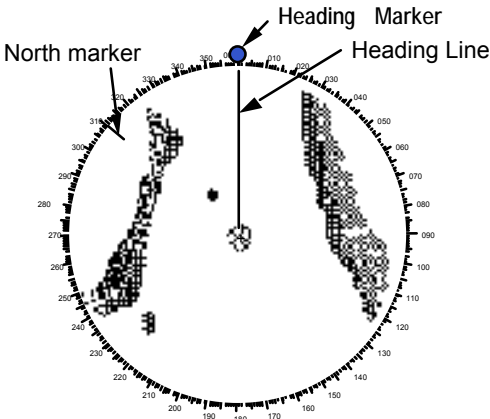
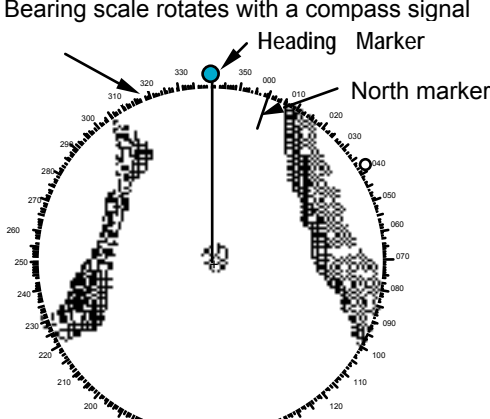
Presentation mode, representative display	Description
	<p>Head-up mode</p> <p>A display without azimuth stabilization in which the line connecting the center with the top of the display indicates own ship's heading.</p> <p>The target pips are painted at their measured distances and in their directions relative to own ship's heading.</p> <p>A shoreline on the bearing scale is the north marker indicating compass north. A failure of the compass input will cause the north marker to disappear and the readout to show xxx.x° and the message GYRO SIGNAL MISSING appears in red at the lower-right corner of the screen.</p>
	<p>Course-up mode</p> <p>An azimuth stabilized display in which a line connecting the center with the top of the display indicates own ship's intended course (namely, own ship's previous heading just before this mode has been selected).</p> <p>Target pips are painted at their measured distances and in their directions relative to the intended course which is maintained at the 0-degree position while the heading line moves in accordance with ship's yawing and course change. This mode is useful to avoid smearing of picture during course change. After a course change, press the [SHIFT] key to reset the picture orientation if you wish to continue using the course-up mode. The heading line gets back to scale zero.</p>
	<p>Head-up TB (True Bearing) mode</p> <p>Radar echoes are shown in the same way as in the head-up mode. The difference from normal head-up presentation lies in the orientation of the bearing scale. The bearing scale is compass stabilized. That is, it rotates in accordance with the compass signal, enabling you to know own ship's heading at a glance.</p> <p>This mode is available only when the radar is interfaced with a gyrocompass.</p> <p>If the compass fails, the bearing scale returns to the state of head-up mode.</p>

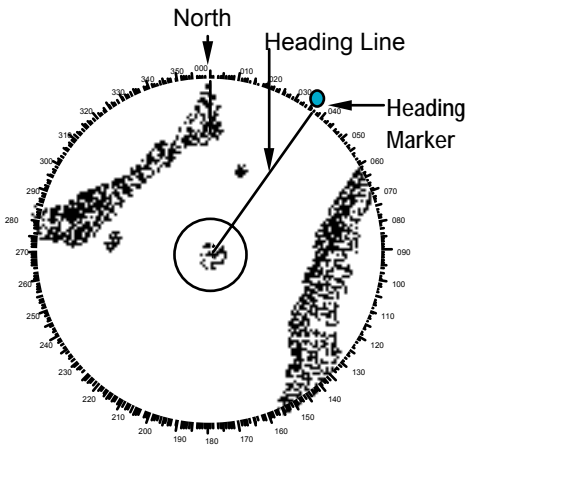
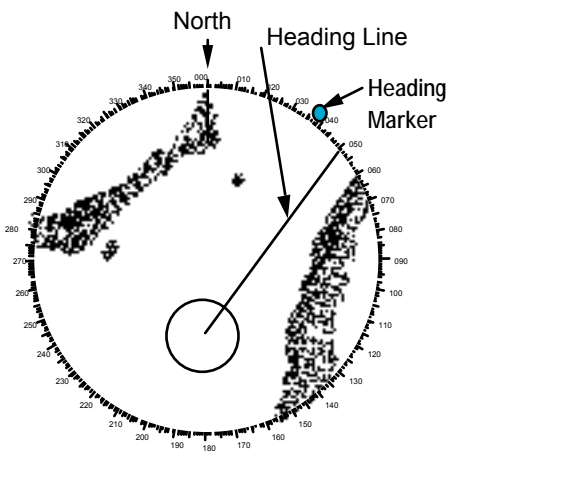
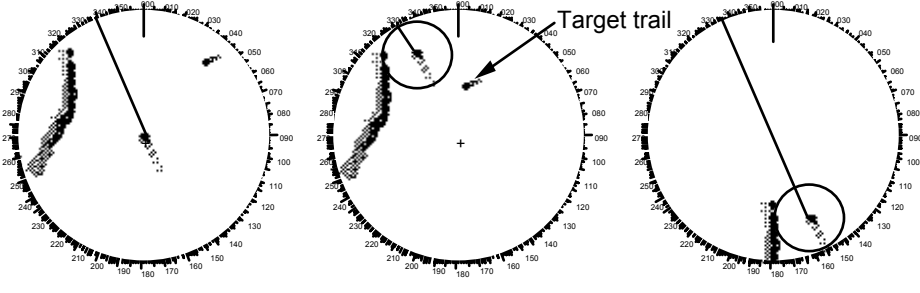
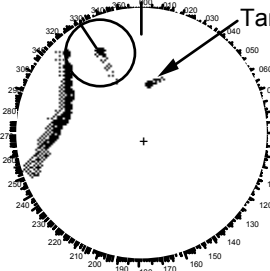
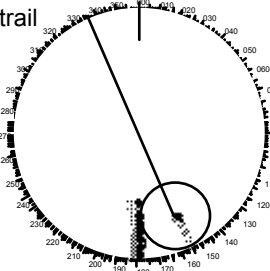
Presentation mode, representative display	Description
 <p>A circular radar display in North-up mode. The scale is in degrees from 000 to 360. A 'North' arrow points to 000. A 'Heading Line' is drawn from the center to a 'Heading Marker' at approximately 030 degrees. Landmasses are visible as dark, textured areas on the left and right sides of the display.</p>	<p>North-up mode □ In the north-up mode, target pips are painted at their measured distances and in their true (compass) directions from own ship, north bearing maintained up of the screen. The heading line changes its direction according to the ship's heading. □ If the gyrocompass fails, the presentation mode changes to head-up and the north marker disappears. Also, the HDG readout shows xxx.x°. And the message GYRO SIG MISSING appears in red at the lower-right corner of the screen.</p>
 <p>A circular radar display in True motion mode. The scale is in degrees from 000 to 360. A 'North' arrow points to 000. A 'Heading Line' is drawn from the center to a 'Heading Marker' at approximately 030 degrees. Landmasses are visible as dark, textured areas on the left and right sides of the display.</p>	<p>True motion mode Own ship and other moving objects move in accordance with their true courses and speed. In ground stabilized TM, all fixed targets, such as landmasses, appear as stationary echoes. In the sea stabilized TM without set and drift inputs, the landmass can move on the screen.</p> <p>When own ship reaches a point corresponding to 75% of the radius of the display, it is automatically reset to a point of 75% radius opposite to the extension of the heading marker passing through the display center. Resetting can be made at any moment before the ship reaches the limit by pressing the [SHIFT]. Automatic resetting is preceded by a beep sound.</p> <p>If the compass fails, the mode is changed to the head-up and the north marker disappears. The HDG readout shows xxx.x° and the message GYRO SIG MISSING appears in red at the lower-right corner of the screen.</p>
<div style="display: flex; justify-content: space-around; align-items: flex-end;"> <div style="text-align: center;">  <p>(a) True motion is selected</p> </div> <div style="text-align: center;">  <p>(b) Own ship has reached a point 75% of display radius</p> </div> <div style="text-align: center;">  <p>(c) Own ship is automatically reset to 75% of radius</p> </div> </div>	

1.12 Selecting the Range Scale

The display range scale is changed by pressing the [+] and [-] keys. The selected range scale and range ring interval are shown at the upper left corner on the screen. When a target of interest comes closer, reduce the range scale so that it appears in 50-90% of the display radius. The range scales are 0.125-0.25-0.5-0.75-1.5-3-6-12-24-48-96 nm.

Press the [RANGE] key to select range. The range, range ring interval and pulselength appear at the top left corner of the display.

1.13 Selecting the Pulselength

The pulselength in use is displayed at the upper-left position. Appropriate pulselengths are preset to individual range scales and function keys. Therefore, you are not usually required to select them. If you are not satisfied with the current pulselength settings, however, it is possible to change them by the ECHO SIG menu as below. The pulselength is selectable on the ranges 0.5 to 24 nm.

1.13.1 Selecting pulselength 1 or 2

1. Press the [MENU] key to display the Main menu.
2. Press the [5] key twice to select ECHO SIG.
3. Press the [6] key or [7] key to select PULSE 1 or PULSE 2 as appropriate.
4. Press the [ENTER/SELECT] key.
5. Press the [MENU] key.

The indication of PULSE 1 or PULSE 2 alternately appears at the upper left corner of the display.

PULSE 1			
1. ↑			
2. 0.5NM	<u>S1</u>	S2	
3. 0.75-1.5NM	S1	<u>S2</u>	M1
4. 3NM	S1	<u>S2</u>	M1 M2 M3
5. 6-12NM	M1	<u>M2</u>	M3 L 6.
24NM	M2	<u>M3</u>	L

Underlined is the default value on each range.

<u>0.07</u>	0.15	μs
0.07	<u>0.15</u>	0.3 μs
0.07	<u>0.15</u>	0.3 0.5 0.7 μs
0.3	<u>0.5</u>	0.7 1.2 μs
0.5 μs	<u>0.7</u>	1.2 μs

1.13.2 Presetting pulselengths 1 and 2

Pulselength 1 and 2 can be preset on the PULSE 1 and PULSE 2 in the ECHO SIG menu. A longer pulse provides an increased detection range, but with reduced discrimination. If you need discrimination in preference to detection, choose a shorter pulse. However short the radar satisfies the detecting requirements of the IMO.

1. Press the [MENU] key.
2. Press the [5] key twice to display the ECHO SIG menu.
3. Press the [6] or [7] key as appropriate to select PULSE 1 or PULSE 2.
4. Press appropriate numeric key among 2-7 to select pulselength and range.
5. Press the [ENTER/SELECT] key.
6. Press the [MENU] key.

1.14 Adjusting the Sensitivity

The GAIN control adjusts the sensitivity of the receiver. It works in precisely the same manner as the volume control of a broadcast receiver, amplifying the signals received.

The proper setting is such that the background noise is just visible on the screen. If you set up for too little sensitivity, weak echoes may be missed. On the other hand excessive sensitivity yields too much background noise; strong targets may be missed because of the poor contrast between desired echoes and the background noise on the display.

To adjust receiver sensitivity, transmit on long range, and adjust the GAIN control so background noise is just visible on the screen.

1.15 Suppressing Sea Clutter

Echoes from waves cover the central part of the display with random signals known as sea clutter. The higher the waves, and the higher the scanner above the water, the further the clutter will extend. When sea clutter masks the picture, suppress it by the A/C SEA control, rotate for manual adjustment, push for automatic adjustment.

1.15.1 Manual adjustment by the A/C SEA control

The A/C SEA control reduces the amplification of echoes at short ranges (where clutter is the greatest) and progressively increases amplification as the range increases, so amplification will be normal at those ranges where there is no sea clutter.

The proper setting of the A/C SEA control should be such that the clutter is broken up into small dots, and small targets become distinguishable.

If the control is set too low, targets will be hidden in the clutter, while if it is set too high, both sea clutter and targets will disappear from the display. In most cases adjust the control until clutter has disappeared to leeward, but a little is still visible windward.

1. Confirm that the sensitivity is properly adjusted, and then transmit on short range.
2. Adjust the A/C SEA control so small targets are distinguishable but some clutter remains on the display.

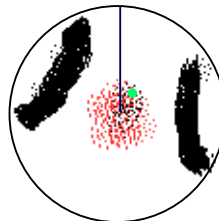

A/C SEA OFF

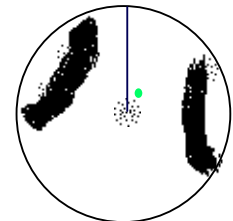

A/C SEA adjusted

1.15.2 Automatic adjustment by the A/C AUTO control

The A/C AUTO control automatically suppresses sea clutter as well as rain clutter. Push the A/C SEA control to turn on the automatic A/C circuit. A/C AUTO appears at the bottom left corner when the A/C circuit is on.



CAUTION

The auto A/C function can erase weak target echoes. Adjust the control carefully watching the display.

1.16 Suppressing Precipitation Clutter

The vertical beamwidth of the scanner is designed to see surface targets even when the ship is rolling. However, by this design the unit will also detect rain clutter (rain, snow, or hail) in the same manner as normal targets. Figure at right shows the appearance of rain clutter on the display.

The A/C RAIN control adjusts the receiver sensitivity as the A/C SEA control does but rather in a longer time period (longer range). Clockwise rotation of this control increases the anti-clutter effect.

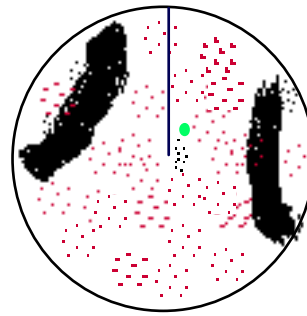

A/C RAIN OFF

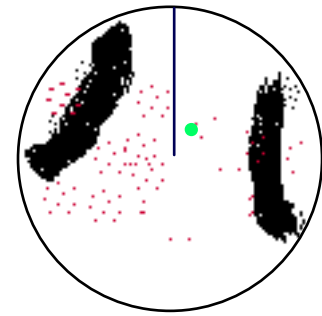

A/C RAIN ON – Thin clouds can be cleared

1.17 Interference Rejector

Mutual radar interference may occur in the vicinity of another shipborne radar operating in the same frequency band (9 GHz). It is seen on the screen as a number of bright spikes either in irregular patterns or in the form of usually curved spoke-like dotted lines extending from the center to the edge of the picture. Activating the interference rejector circuit can reduce this type of interference.

The interference rejector is a kind of signal correlation circuit. It compares the received signals over successive transmissions and suppresses randomly occurring signals. There are three levels of interference rejection depending on the number of transmissions that are correlated. These are indicated by the legends IR1, IR2 and IR3 at the upper-left position of the screen.

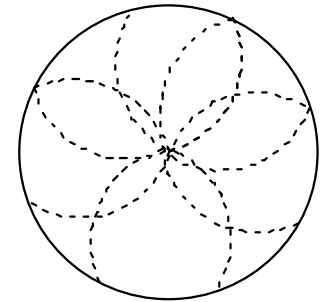

To activate the interference rejector;

1. Press the [F1] key. The following display appears.

1.	VECTOR	T/R
2.	PULSE	
3.	INT REJ	
4.	STRETCH	
5.	ECHO AVG	
6.	CONTRAST	
7.	N REJ	
8.	DISP SEL	
9.	PM	
0.	SART	

2. Press the [3] key to select interference rejection level (OFF, 1, 2, or 3) from the INT REJ field. Selected level is shown as IR1, IR2 or IR3 at the bottom left-hand corner on the display.

1.18 Measuring the Range

Use the fixed range rings to obtain a rough estimate of the range to a target. They are the concentric solid circles about own ship, or the sweep origin. The number of rings is automatically determined by the selected range scale and their interval is displayed at the upper-left position of the screen.

1.18.1 Measuring range by the variable range marker (VRM)

Use the Variable Range Markers (VRMs) for more accurate measurement of the range to a target. There are two VRMs, No.1 and No.2, which appear as dashed rings so that you can discriminate them from the fixed range rings. The two VRMs can be distinguished from each other by different lengths of dashes.

1. Press the [VRM ON] key to display either of the VRMs. Successive presses of the [VRM ON] key toggles the active VRM between No.1 and No.2 and the currently active VRM readout is circumscribed.
2. Rotate the VRM rotary control clockwise or counterclockwise to align the active VRM with the inner edge of the target of interest and read its distance (unit: nm) at the lower-right corner of the screen. Each VRM remains at the same geographical distance when you operate the [RANGE+] or [RANGE-] key. This means that the apparent radius of the VRM ring changes in proportion to the selected range scale.
3. Press the [VRM OFF] key to erase each VRM.

1.19 Measuring Bearing

Use the Electronic Bearing Lines (EBLs) to find bearing of a target. There are two EBLs, No.1 and No.2, which are toggled by successive presses of the [EBL ON] key. Each EBL is a straight dashed line extending out from the own ship position up to the circumference of the radar picture. The fine dashed line is the No.1 EBL and the coarse dashed one is the No.2 EBL.

1. Press the [EBL ON] key to display either of the EBLs. Successive presses of the [EBL ON] key toggles the active EBL between No.1, No.2 and index lines (if displayed) and the currently active EBL readout is circumscribed.
2. Rotate the EBL rotary control clockwise or counterclockwise until the active EBL bisects the target of interest, and read its bearing at the lower-left corner of the screen.
3. Press the [EBL OFF] key to erase each EBL.

The EBL readout is affixed by R (relative) if it is relative to own ship's heading, or T (true) if it is referenced to the North, as determined by the item EBL/VRM/+ on the OTHERS menu.

Note 1: Bearing reference cannot be selected for IMO type (no menu selection). For the IMO type, relative bearing is selected in the HU mode, and true bearing in HUTB, CU, NU and TM modes.

Note 2: The cursor may be returned to OS position by pressing the VRM control (R-type only).

1.20 Collision Assessment by the Offset EBL

The origin of the EBL can be placed anywhere with the trackball to enable measurement of range and bearing between any targets. This function is also useful for assessment of the potential risk of collision.

To assess possibility of collision:

1. Press the [EBL ON] key to display or activate the No.1 EBL.
2. Place the cursor (+) on a target appearing as threatening (A in the illustrated example) by operating the trackball.
3. Press the [EBL OFFSET] key, and the origin of the active EBL shifts to the cursor position. Press the [EBL OFFSET] key again to anchor the EBL origin.
4. After waiting for a few minutes (at least 3 minutes), operate the EBL rotary control until the EBL bisects the target at the new position (A'). The EBL readout shows the target ship's course, which may be true or relative depending on the settings on the OTHERS menu.

If relative motion is selected, it is also possible to read CPA (Closest Point of Approach) by using a VRM as shown below (Figure (a)). If the EBL passes through the sweep origin (own ship) as illustrated (Figure (b)), the target ship is on a collision course.

- To return the EBL origin to the own ship position, press the [EBL OFFSET] key again.

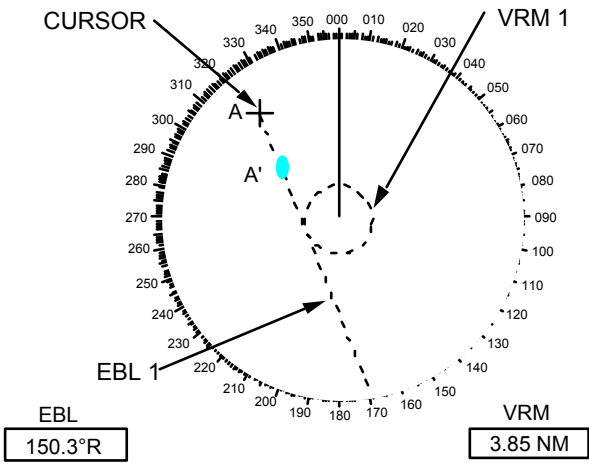

(a) Evaluating the target ship course in RM

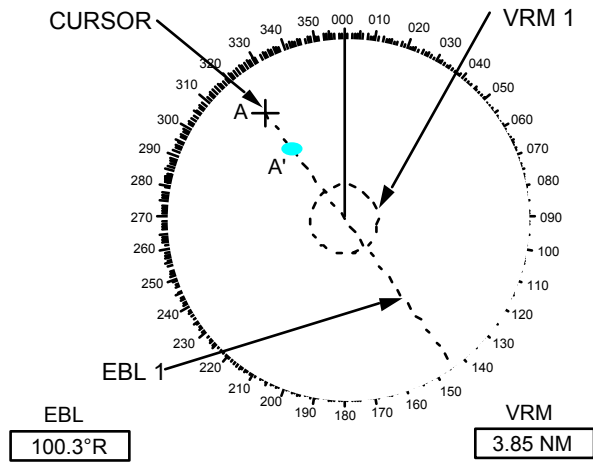

(b) Target ship on collision course

1.21 Measuring Range and Bearing Between Two Targets

1. Press the [EBL OFFSET] key, and place the origin of the No.1 EBL on a target of interest (target 1 in the illustrated example) by operating the trackball. Note: Only No. 1 EBL can be offset.
2. Turn the EBL rotary control until the EBL passes through another target of interest (target 2).
3. Turn the VRM rotary control until the range marker on the No. 1 EBL aligns with target 2. The NO. 1 VRM readout at the lower-right corner of the screen indicates the distance between the two targets.
4. To return the EBL origin to the own ship position, press the [EBL OFFSET] key again.

Bearing is shown relative to own ship with suffix "R" or as a true bearing with suffix "T" depending on EBL relative/true settings on the OTHERS menu.

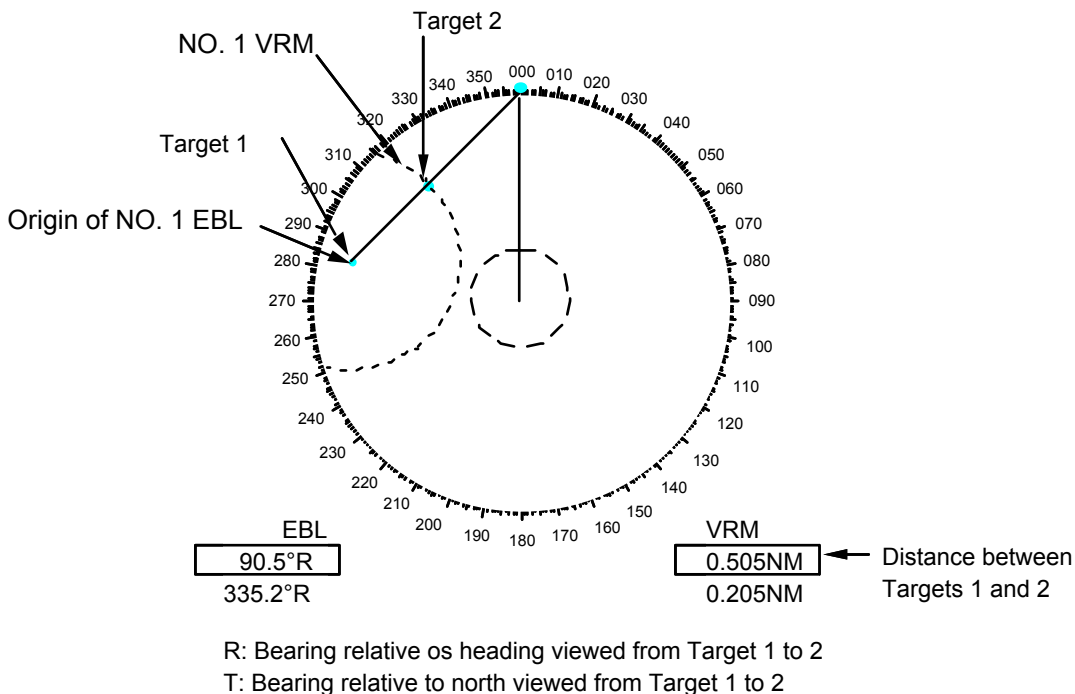

1.22 Setting a Target Alarm Zone



CAUTION

The target alarm feature should never be relied upon as the sole means for detecting the risk of potential collision. The operator of a ship is not relieved of the responsibility to keep lookout for avoiding collisions, whether or not the radar is in use.

1.22.1 Introduction

There are two independent Target Alarm Zones. NO. 1 zone has a default coverage of 3.5-4 nm and is adjustable within 3.0 to 6.0 nm. NO. 2 zone may be adjusted anywhere when the NO. 1 TAZ is valid. On the R-type, the outer and inner boundaries can be set at any distance. In any radar type, the sector of the zones can be set anywhere between 0 and 360 degrees in any direction. When the radar is equipped with Automatic Tracking Aid (ATA) or ARPA, a Guard Zone alarm is also available.

To set target alarm zones:

1. Press the [MENU] key and press the [3] key twice to show the TGT ALARM menu.

TGT ALARM			
1. AREA NO.	NO 1	NO 2	
2. MODE 1	IN	OUT	
3. MODE 2	IN	OUT	

In R-type, you can use NO. 1 as TAZ by selecting **IN** and NO. 2 as an Anchor Watch by selecting **OUT**. In IMO type, only IN is available.

2. Press the [1] key to select guard zone to use NO 1 or NO 2.
3. Press the [ENTER/SELECT] key.
4. Press the [MENU] key.
5. Place the cursor (+) at point "A" (see figure below) using the trackball. Press the [TGT ALARM] key. SET TA1(2) appears at the lower-right corner on the screen. When both alarms are prepared the active alarm is circumscribed.
6. Move the cursor (+) to point "B" and press the [TGT ALARM] key again. Then, an echo watch zone as illustrated is created and the label TA1 (or 2) appears instead of SET TA1 (or 2) at the lower-right corner of the screen.

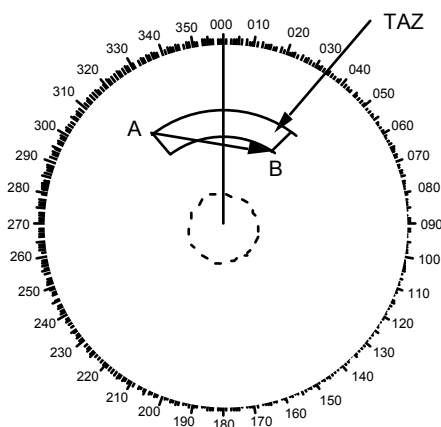

Target alarm zone (TAZ) can be set in any sector between 3 and 6 nm on IMO-type, and anywhere on the R-type.

When the radar has the ATA board ARP-17, a total of 3 alarm zones (two TAZs and one GZ) may be set.

The 2nd TAZ is available only when the 1st TAZ is valid.

Note: To create a target alarm zone having a 360-degree coverage around own ship, set point B in almost the same direction (approx. $\pm 3^\circ$) as point A and press the [TGT ALARM] key.

Two alarm zones can be set as described above. To change the active alarm zones, do steps 1 through 4 in the above procedure. (When both alarms are prepared the active alarm indication is circumscribed.)

1.22.2 Acknowledging alarm

A target entering the ALARM zone produces both visual (flashing) and audible (beeping) alarms. To silence the audible alarm, press the [AUDIO OFF] key shortly. ACK replaces IN (or OUT).

This will deactivate the audible alarm but will not stop the flashing of the target in the target alarm zone. To reactivate the audible alarm, press the [AUDIO OFF] key again.

To silence the audible alarm, you may press the [AUDIO OFF] key. However, in this case, the label ACKN does not appear.

Hold the [AUDIO OFF] key depressed for at least 5 seconds to disable the target alarm.

Note: The target alarm is given to targets having a certain level of echo strength. This level does not always imply a landmass, reef, ships or other surface objects but can mean returns from the sea surface or precipitation. Properly adjust the GAIN, A/C SEA, and A/C RAIN controls to reduce noise to avoid generation of the guard alarm against false targets.

On the R-type, an inward or outward target alarm can be selected on the TGT ALARM menu. On the IMO type, only the inward guard alarm is available. The inward guard alarm generates visual and audible warnings when a target enters the target alarm zone from any direction. The outward target alarm is produced when a target leaves the target alarm zone. (This is not a target alarm by definition but an anchor watch, which some users find valuable.)

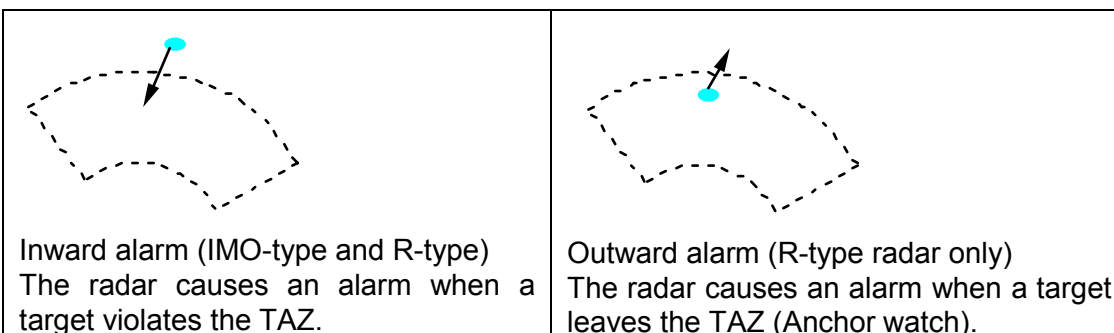

1.23 Off-centering (shift)

Own ship position, or sweep origin, can be displaced to expand the view field without switching to a larger range scale. The sweep origin can be off-centered to a point specified by the cursor, up to 75% of the range in use in any direction.

This feature is not available on the longest range scale or in the true motion mode. The number of range rings increases keeping the original range intervals unchanged. To off center the radar picture:

1. Place the cursor at a position where you wish to move the sweep origin by operating the trackball.
2. Press the [SHIFT/ZOOM] key with a touch-and-release action. Then, the sweep origin is off-centered to the cursor position. However, the heading line is left in the same position.
3. To cancel off-centering, press the [SHIFT/ZOOM] key again.

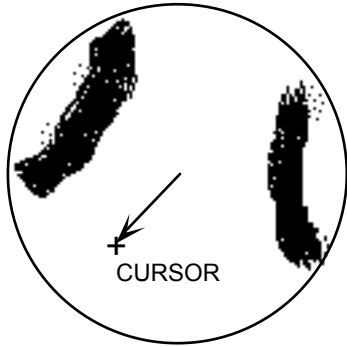

(a) Select location with cursor

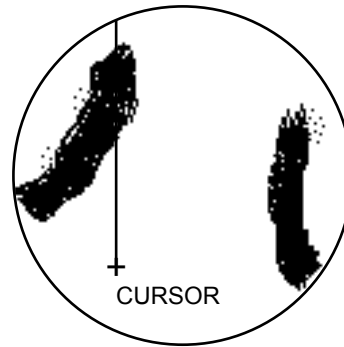

(b) Press SHIFT key to offcenter

Note: The display is automatically reset to 75% of the range in use whenever the cursor is placed at an edge of the effective display area. Note also that the heading marker (small circle on the bearing scale) leaves the heading line on off-centered display, always indicating the correct direction of the own ship heading.

1.24 Echo Averaging

The echo average feature effectively suppresses sea clutter. Echoes received from stable targets such as ships appear on the screen at almost the same position every rotation of the scanner. On the other hand, unstable echoes such as sea clutter appear at random positions.

To distinguish real target echoes from sea clutter, echo average performs scan-to-scan correlation. Correlation is made by storing and averaging echo signals over successive picture frames. If an echo is solid and stable, it is presented in its normal intensity. Sea clutter is averaged over successive scans resulting in the reduced brilliance, making it easier to discriminate real targets from sea clutter.

To properly use the echo average function, it is recommended to first suppress sea clutter with the A/C SEA control and then do the following:

1. Press the [F1] key.
2. Press the [5] key twice to select ECHO AVG.

ECHO AVG	
1.	VECTOR T/R
2.	PULSE
3.	INT REJ
4.	STRETCH
5.	ECHO AVG
6.	CONTRAST
7.	N REJ
8.	DISP SEL
9.	PM
0.	SART

3. Press the [5] key to select echo averaging level desired from the ECHO AVG field.

OFF: No averaging effect

0.5: Distinguishes small targets from sea clutter.

1: Helps distinguish targets from sea clutter and suppresses brilliance of unstable echoes.

2: Distinguishes small stationary targets such as navigation buoys.

3: Stably displays distant targets.



(a) Echo average OFF

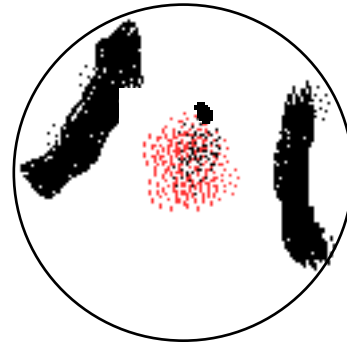

(b) Echo average ON

Echo averaging uses scan-to-scan signal correlation technique based on the true motion over the ground of each target. Thus, small stationary targets such as buoys will be shown while suppressing random echoes such as sea clutter. True echo average is not however effective for picking up small targets running at high speeds over the ground.

Echo average is inoperable when a compass signal is not available. If you wish to use this feature without a compass signal, consult a FURUNO representative.



Do not use the Echo Average function under heavy pitching and rolling; loss of target detection can result.

1.25 Electronic Plotting Aid (EPA)

10 targets can be plotted electronically to assess their motion trend. Five past positions can be displayed for each target. Working range of EPA is 0-48 nm irrespective of range scale. Note that EPA is disabled when the ATA (ARP-17) is accommodated.

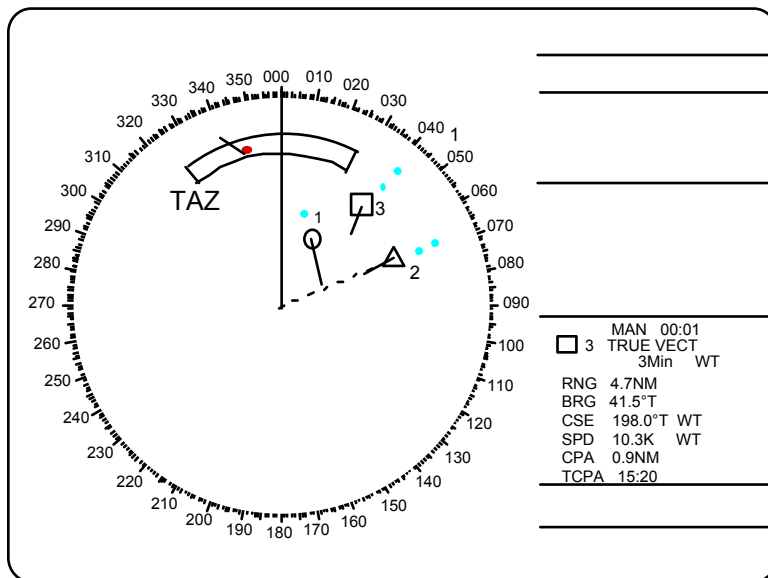

Target data is shown in the data display area including range, bearing, course, speed, CPA and TCPA of the last-plotted or selected target.

EPA SYMBOLS

- Target plotted
 - Plotted target and the data being read
- Flashing: Targets in Target Alarm Zone
- △ Target on a collision course

Target 2 is on a collision course as the extension of its vector goes through the own ship position. Placing the offset EBL will help for assessment. TCPA is counted up to 99.59 min and beyond that it is indicated as TCPA > 99.99 min.

Note: Plots will be lost when the compass or speed log fails.

1.25.1 Plotting a target

- Place a cursor on a target of interest and press the [PLOT SYMBOL] key. The target position changes with a calculated speed and course every 1-2 seconds by the auto follow-up feature, maintaining the calculation origin at point (a). If option (7) TRACK is ON, tracked positions are indicated by dots.
- In more than 30 seconds but within 10 minutes, place the cursor on the latest calculated position (b) and press the [ENTER/SELECT] key. The plot symbol changes from ○ to □. This step is to identify the target on which you want the plotting data.
- Place the cursor on the target within 5 seconds, maybe at a different location due to leeway at (c), and press [PLOT SYMBOL] key. The vector will be drawn based on a trip between (a) and (c). The target data is indicated in the text area to the right. Correction of plot position (c'), if necessary, is possible within 5 seconds, to show the course made good and speed made good (a-c').
- Do the same for other targets (maximum 10). For targets already in auto follow-up, do steps 2 and 3.

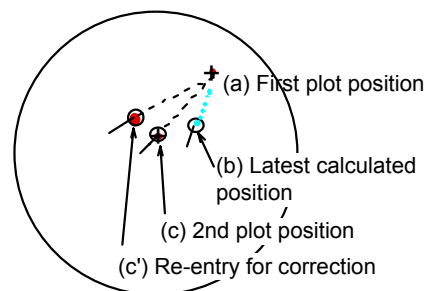

Note: If a target once plotted is not plotted again within 10 minutes, the warning “UPDATE PLOT” and plot number will appear on the lower right margin of the screen and the plot symbol of the target flashes. Plotting of a target will be ceased if the time between consecutive plots exceeds 10 minutes. If you want to continue plotting this target, reacquire it within 5 minutes. Otherwise, the target will be regarded as a “lost target” and its plot symbol and target data will be erased. The larger the plotting interval, the less accurate the plotted target data. Plotting of each target should normally be made every 3 or 6 minutes as far as possible. You can use the Watch Alarm to warn yourself every 3 or 6 minutes.

1.25.2 Cancelling

Place the cursor on the plot symbol and press the [CANCEL/CLEAR] key.

1.25.3 Vectors

Vectors can be displayed relative to own ship’s heading (Relative) or with reference to the North (True). This feature is available in all presentation modes (compass must be working correctly). The current vector mode is indicated at the right of the screen.

Vector time (or the length of vectors) can be set to 30 seconds, 1, 3, 6, 15 or 30 minutes and the selected vector time is indicated at the upper-right corner of the screen.

1. Press the [MENU] key followed by the [7] key twice to select PLOT.
2. Press the [3] key select REL or TRUE from the VECT REF field as appropriate and press the [ENTER/SELECT] key.
3. Press the [4] to select appropriate vector time from the VECT TIME field.
4. Press the [ENTER/SELECT] key to conclude your selection.
5. Press the [MENU] key to close the menu.

The vector tip shows an estimated position of the target after the selected vector time elapses. It can be valuable to extend the vector length to evaluate the risk of collision with any target.

The radar calculates motion trends (range, bearing, course, speed, CPA and TCPA) of all plotted targets.

In the head-up and head-up true bearing modes, target bearing, course and speed shown in the upper-right target data field become true (T) relative to north or relative (R) relative to own ship in accordance with true/relative vector setting. In the North-Up, Course-Up, and True Motion modes, the target data field always displays true bearing, true course and speed over the ground.

PLOT MENU 1	
1.	MARK DISP OFF <input checked="" type="checkbox"/> ON
2.	ERASE
3.	VECT REF REL TRUE
4.	VECT TIME (min) 30sec 1 3 6 15 30
5.	CPA SET OFF 0.5NM 1NM 1.5NM 2NM 3NM 4NM 5NM 6NM
6.	TCPA SET (min) 30sec 1 2 3 4 5 6 12 15
7.	TRACK OFF ON
8.	AUDIO ALARM OFF ON
9.	PLOT No. DISP OFF ON

1.25.4 Reading the target data

Place cursor on the target and press the [ENTER/SELECT] key. The selected target is marked with . The following target data is displayed at the right side of the CRT.

RNG/BRG (Range/Bearing): Range and bearing from own ship to last-plotted target with suffix T (True).

CSE/SPD (Course/Speed): Course and speed are displayed for the last-plotted target with suffix T (True).

CPA/TCPA: CPA (Closest Point of Approach) is the closest range the target will approach to own ship. TCPA is the time to CPA. Both CPA and TCPA are automatically calculated. TCPA is counted up to 99.59 min and beyond that it is indicated as TCPA > *99.59 MIN.

1.25.5 Terminating target plotting

With EPA you can plot up to 10 targets. You may wish to terminate plotting of less important targets to newly plot other threatening targets.

With Trackball: Place the cursor (+) on a target which you do not want to be tracked any longer by operating the trackball and press the [CANCEL/CLEAR] key.

All Targets: To terminate plotting of all targets at once:

1. Press the [MENU] key followed by the [7] key.
2. Press the [2] key twice to select OFF from the ERASE field.
3. Press the [ENTER/SELECT] key followed by the [MENU] key.

1.25.6 Setting CPA/TCPA alarm ranges

When the predicted CPA of any target becomes smaller than a preset CPA alarm range and its predicted TCPA less than a preset TCPA alarm limit, the EPA releases an audible alarm and displays the warning indication COLLISION on the screen. In addition, the EPA symbol changes to a triangle and flashes together with its vector.

Provided that this feature is used correctly, it will help prevent the risk of collision by alerting you to threatening targets. It is important that GAIN, A/C SEA, A/C RAIN and other radar controls are properly adjusted.

CPA/TCPA alarm ranges must be set up properly taking into consideration the size, tonnage, speed, turning performance and other characteristics of own ship.



CAUTION

CPA/TCPA

The CPA/TCPA alarm feature should never be relied upon as the sole means for detecting the risk of collision. The navigator is not relieved of the responsibility to keep visual lookout for avoiding collisions, whether or not the radar or other plotting aid is in use.

To set the CPA/TCPA alarm ranges:

1. Press the [MENU] key.
2. Press the [7] key twice to display the PLOT 1 menu.
3. Press the [5] key for CPA SET or [6] key for TCPA set.
4. Press the [5] key or [6] key again to select CPA or TCPA range desired.
5. Press the [ENTER/SELECT] key to register your selection.
6. Press the [MENU] key to close the menu.

1.25.7 Silencing CPA/TCPA audible alarm

Press the [AUDIO OFF] key to acknowledge and silence the CPA/TCPA audible alarm.

The warning label COLLISION and the flashing of the triangle plot symbol and vector remain on the screen until the dangerous situation is gone or you intentionally terminate tracking of the target by using the trackball.

1.25.8 Past plot points

Past plot points may be marked on the display by dots. Up to nine dots can be displayed as follows:

1. Press the [MENU] key.
2. Press the [7] key twice to reach the PLOT MENU 1.
3. Press the [7] key to select OFF or ON from the TRACK field as appropriate.
4. Press the [ENTER/SELECT] key to register your selection followed by the [MENU] key to close the menu.

1.25.9 Displaying plot No.

Plot numbers can be turned on/off as follows.

1. Press the [MENU] key followed by [7] key twice to show PLOT MENU 1.
2. Press the [9] key to select PLOT No. DISP ON or OFF as appropriate.
3. Press the [ENTER/SELECT] key to register your selection followed by the [MENU] key to close the menu.

1.26 Target Trails (Echo Trails)

It is possible to display the trails of the radar echoes of targets in the form of synthetic afterglow. Target trails are selected either relative or true and may be sea or ground stabilized. The simulated afterglow can be selected in a single tone or gradual shading depending on a setting on the TGT TRAIL menu.

1.26.1 True or relative trails

Target trails may be displayed relative to north or own ship's heading on Relative Motion, and only relative to north on True Motion. True motion trails require a compass signal and own ship speed input.

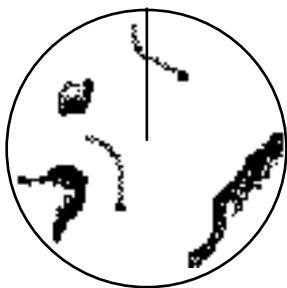

(a) True target trails – no smearing of stationary targets

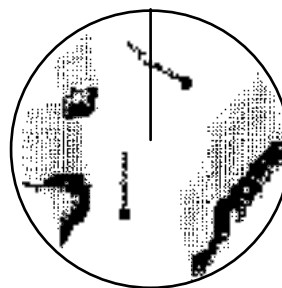

(b) Relative target trails – all targets moving relative to own ship

Note: When true trail is selected on the RM mode, the legend TRUE TRAIL appears in red.

To select true or relative target trail presentation:

1. Press the [MENU] key.
2. Press the [2] key twice to show the TGT TRAIL menu.

TGT TRAIL	
1. TIME (min)	15sec 30sec 1 3 6 15 30 CONT
2. MODE	REL TRUE
3. SHADE	MONO MULTI
4. LEVEL	1 2 3
5. TRAIL COPY	OFF ON
6. THIN TRAIL	OFF ON
7. THIN MODE	1 2 3 4

(7. R-type only)

3. Press the [2] key several times to select REL or TRUE from the MODE field as appropriate.
4. Press the [ENTER/SELECT] key to confirm your selection, then the [MENU] key to close the menu.

1.26.2 Trail gradation

Target trails may be shown in monotone or multitone. Gradual shading paints the trails getting thinner with time just like the afterglow on an analog PPI radar.



Monotone



Multitone

1. Press the [MENU] key.
2. Press the [2] key twice to select TGT TRAIL.
3. Press the [3] key to select MONO or MULTI from the SHADE field as appropriate.
4. Press the [ENTER/SELECT] key and the [MENU] key in order.

1.26.3 Displaying and erasing target trails

Press the [TGT TRAIL] key to activate or deactivate the target trails feature. The current target trail setting is displayed at the upper right-and corner of the screen.

Note: Holding the [TGT TRAIL] key depressed for about 3 seconds will cause a loss of target trail data so far stored in memory.

1.26.4 Thin trails

Target trails may be painted in thinner trails. This is useful when there are a lot targets and their trails would create congestion on the screen.

1. Press the [MENU] key.
2. Press the [2] key twice to select TGT TRAIL.
3. Press the [6] key to select ON or OFF from the THIN TRAIL field as appropriate.
4. **For the R-type radar**, you may select the degree of thinness from the THIN MODE field. The higher the number the thinner the trail. Press the [7] key to select degree of thinness desired.
5. Press the [ENTER/SELECT] key and the [MENU] key in order.

1.26.5 Restoring trails

Trails are cancelled and restarted whenever the range is changed. However, you can continue trails on the same range, without restarting, when the range is changed to a next larger or smaller range scale. Note however that when the range is changed, only those target trails within the previous range are continued; no trails are generated for targets outside of the previous range.

1. Press the [MENU] key.
2. Press the [2] key twice to select TGT TRAIL.
3. Press the [5] key to select ON from the TRAIL COPY field.
4. Press the [ENTER/SELECT] key and [MENU] key in order.

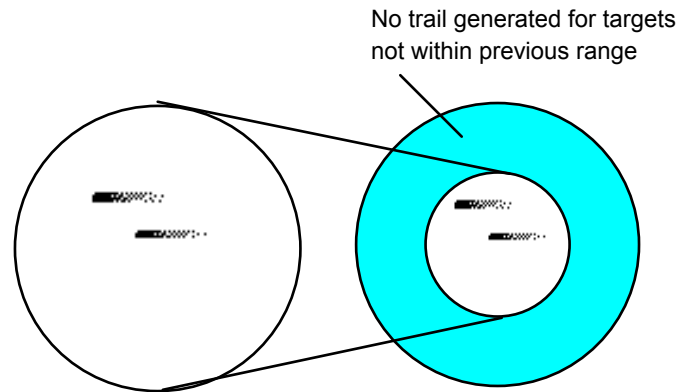

1.26.6 Resetting target trails

(a) Previous range

(b) New range

To reset (or clear) the target trail memory, hold the [TGT TRAIL] key depressed for about 3 seconds. Target trails are cleared and the trailing process restarts from time count zero at current target trail plot interval.

1.26.7 Trail brilliance

The brilliance of target trails can be adjusted on the BRILL menu as follows:

1. Press the [MENU] key.
2. Press the [9] key twice to display the BRILL menu.

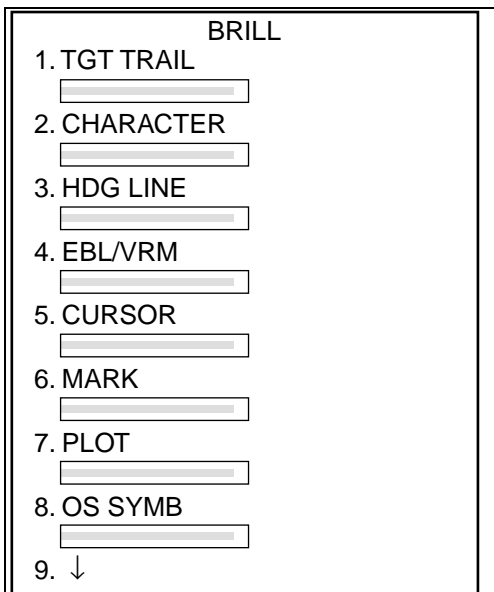

Menu item No. 9 requires RP-17 board.

3. Press the [1] key to select TGT TRAIL.
4. Operate the VRM rotary control to adjust brilliance. Current brilliance is shown by the bar graph.
5. Press the [ENTER/SELECT] key to conclude your selection followed by the [MENU] key to close the menu.

1.27 Parallel Index Lines

Parallel index lines are useful for keeping a constant distance between own ship and a coastline or a partner ship when navigating. The orientation of the index lines is controlled with the EBL rotary control and the intervals between the lines is adjustable with the VRM rotary control (provided that No.2 VRM is active).

1.27.1 Displaying/erasing the index lines

Press the [INDEX LINE] key to disconnect the VRM. Press the [INDEX LINE] key to display/erase the index lines.

1.27.2 Selecting number of index lines to display

Maximum number of the index lines can be set for 2 or 6 on the MARK/LINE sub menu in the OTHERS menu.

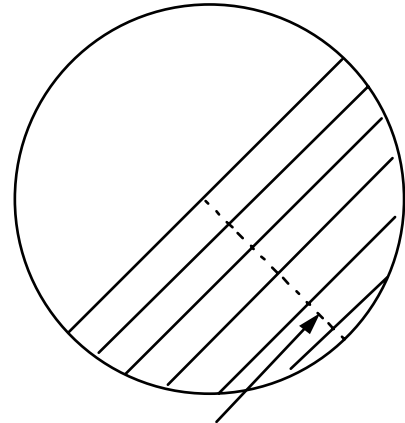

Bearing of PI Lines

1.28 Reference Mark (not available with Video Plotter RP-17 or RP-180)

You can mark any reference points, prominent target or a point of particular interest using the reference mark feature. This mark is geographically fixed, namely, ground stabilized. Twenty such reference marks can be entered. Note this feature is inoperative when the RP-17 or RP-180 is installed.

To use the reference mark:

1. Place the cursor (+) at a point where you want to place a reference mark by operating the trackball.
2. Press the [MARK] key. The reference mark appears at the cursor position. The cursor location is indicated on the screen.

1.28.1 Inscribing mark reference

The reference mark can be set relative to own ship, or referenced to land (sea or ground stabilized).

1. Press the [MENU] key.
2. Press the [8] key twice to select MARK.

	MARK	
1. ERASE		
2. MODE	REL TRUE	

3. Press the [2] to select the REL or TRUE as required.
4. Press the [ENTER/SELECT] key, then [MENU].

1.28.2 Erasing reference marks

Erasing individual reference marks

Select the Reference mark with the cursor and then press the [CANCEL/CLEAR] key.

1.28.3 Erasing all reference marks

1. Press the [MENU] key.
2. Press the [8] key twice to select MARK.
3. Press the [1] key twice.
4. Press the [MENU] key.

1.29 Zoom (R-type only)

The zoom function is available on the R-type radar only, and it enlarges an area of interest as large as twice the normal viewing.

1. Place the cursor (+) close to the point of interest by operating the trackball.
2. Press and hold down the [SHIFT/ZOOM] key for about two seconds. The area around the cursor and own ship is enlarged twice as large as the original size.
3. To cancel zoom, press and hold down the [SHIFT/ZOOM] key about two seconds.

Note: The zoom feature is inoperative when the display is off centered.

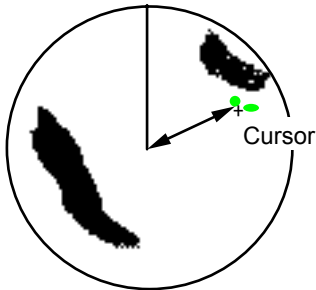

Place the cursor at a position of interest

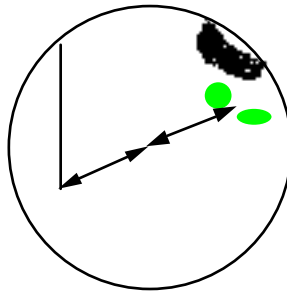

ZOOM in
(Regular type only)

1.30 Markers

Heading line, north marker, stern marker, own ship symbol

The heading line indicates the ship's heading in all presentation modes. It is a line from the own ship position to the outer edge of the radar display area and appears at zero degrees on the bearing scale in head-up mode, it changes the orientation depending on the ship orientation in the north-up and true motion modes. The heading marker appears as a small circle on the bearing scale to indicate the heading when the display is shifted or is in the north-up or TM mode.

Temporarily erasing heading line, north marker, stern marker, own ship symbol

To temporarily extinguish the heading line to look at targets existing dead ahead of own ship, press the GAIN control. The heading line reappears when the control is released.

Note that the Video Plotter screen (requires RP-17) is also temporarily erased when the GAIN control is pressed.

North marker

The north marker appears as a short dashed line. In the head-up mode, the north marker moves around the bearing scale in accordance with the compass signal.

Stern marker

The stern marker (a dot-and-dash line) appears opposite to the heading line. It can be displayed/erased on the MARK/LINE sub menu in the OTHERS menu ([MENU], [0], [0]).

Own ship symbol

The own ship symbol () can be displayed/erased on the MARK/LINE sub menu in the OTHERS menu. The symbol is scaled to indicate the length and beam of the vessel. If the largest dimension of the symbol gets smaller than 6 mm, the symbol will disappear and own ship will be represented with a small dot or circle depending on the range in use. NOTE: Details should be entered during installation.

1.31 Suppressing Second-trace Echoes

In certain situations, echoes from very distant targets may appear as false echoes (second-trace echoes) on the screen. This occurs when the return echo is received one transmission cycle later, that is, after a next radar pulse has been transmitted.

To activate or deactivate the second-trace echo rejector:

1. Press the [MENU] key followed by the [5] key twice to display the ECHO SIG menu.

ECHO SIG	
1. COLOR	YEL GRN *
2. CLTR SWEEP	OFF ON (LINK) ON(FIX)
3. SWEEP LEVEL	1 2 3
4. ENHANCE	OFF ON
5. 2 ND ECHO	OFF ON
6. PULSE 1	
7. PULSE 2	
8. A/D CURVE	A B C D
9. CNTR ENHANCE	OFF ON
0. REALTIME HU	OFF ON

* COLOR additional to R-type
(8. R-type only)
(9. R-type only)
(0. R-type only)

2. Press the [5] key to select OFF or ON.
3. Press the [ENTER/SELECT] key to conclude your selection followed by the [MENU] key to close the menu.

1.32 [F1] Key

The [F1] key allows instant access to the primary function controls.

1. Press the [F1] key. The following menu appears.

1. VECTOR	T/R	Vector mode: True or Relative. Press [F1], [1].
2. PULSE		Pulselength selection
3. INT REJ		Interference rejector; Ref. 1.17.
4. STRETCH		Echo stretch; Ref. 1.36.
5. ECHO AVG		Echo average; Ref. 1.24.
6. CONTRAST		Contrast of video; Ref. 1.36.
7. N REJ		Noise rejector; Ref. 1.38.
8. DISP SEL		[ENTER/SELECT] toggles display between Main and Sub.
9. PM		Activates Performance Monitor. Refer to Chapter 7.
0. SART		Optimum setting for detecting SART; Refer to 3.3.

2. Press appropriate numeric key. For example, press the [4] key to select desired echo stretch level. Each press of the [4] key selects echo stretch level.

1.33 [F2] Key

The [F2] key selects the level or setting for one of the parameters as selected at step 3 below on the STBY screen.

1.33.1 Presetting the [F2] key

1. In the STANDBY condition, press the [MENU] key.
2. Press the [6] key twice to display the FUNC menu.

FUNC		
1. FUNC 1	OFF	ON
2. FUNC 2	OFF	ON
3. FUNC 3	OFF	ON
4. FUNC 1 SET		
5. FUNC 2 SET		
6. FUNC 3 SET		
7. F•2 SET		

F2 SET option not valid in TX mode; valid on STBY only.

3. Press the [7] key twice to select F•2 SET. The following display appears:

[F2 MENU]	
Select by VRM knob and press ENTER key.	
1. TRAIL TIME	21. SART
2. TRAIL MODE	22. WATCH TIME
3. TRAIL SHADE	23. STERN MARK
4. TRAIL LEVEL	24. OS MARK
5. ALARM AREA	25. TUNE A/M
6. ALARM MODE	26. EXT WPT
7. TGT COLOR	27. OS POSN
8. ECHO AVG	28. CLTR SWEEP
9. INT REJ	29. P.MONITOR
10. ECHO STRETCH	30. EBL/+/PI
11. NOISE REJ	31. VRM/+ RNG*1
12. ECHO ENHANCE	32. AIS(1) MENU*2
13. 2ND ECHO	33. AIS DATA*2
14. CONTRAST	
15. PLOT MENU	
16. MARK MODE	
17. BRILL MENU	
18. DRIFT MENU	
19. NAV DATA	
20. DISPLAY	

*1: R-type only

*2: on IMO-type radar,
31 is AIS(1) MENU and
32 is AIS DATA. These
are not shown on RP-17.

(This screen appears only in the STBY condition.)

4. Select function desired with the VRM rotary control.
5. Press the [ENTER/SELECT] key to register your selection, and then press the [MENU] key to finish.

Then, a single press of [F2] turns on the function preprogrammed in the procedure above.

1.34 FUNCTION Key

The FUNCTION key works similar to the automatic dialing feature on a telephone, playing back control settings just as they were registered. Instead of manually adjusting controls to set up for a particular condition, for example, navigation in a harbor, you can have the [FUNCTION] key to do it for you.

1.34.1 Presetting the FUNCTION key

The radar's internal computer offers several navigation condition setups as outlined in the table below. For instance, you might want to preset the level of parameters as HBR (Harbor) in FUNC which you can later select among FUNC 1, 2 or 3 by pressing the [FUNCTION] key.

Each setup option defines a combination of several radar settings for achieving optimum setup for a particular navigating situation. Those involved are echo average, interference rejector, echo stretch, noise rejector, enhanced video, video contrast, automatic anti-clutter.

Adjusting these features on a function key menu changes the original function key settings. To restore the original settings for a particular function key, it is necessary to display the relevant function key menu and select appropriate menu options.

1. Press the [MENU] key (Ref. 1.33/1 – 2).
2. Press the [6] key twice to display the FUNC menu.
3. Press [4], [5] or [6] twice to select which function number to preset. For example, press the [4] key to select FUNC 1.

FUNC 1				FUNC 2				FUNC 3			
1.	↑			1.	↑			1.	↑		
2.	FUNC SEL	CST	OCEAN	2.	FUNC SEL	CST	OCEAN	2.	FUNC SEL	CST	OCEAN
		R-SEA	FLT BY			R-SEA	FLT BY			R-SEA	FLT BY
		HBR L	RAIN			HBR L	RAIN			HBR L	RAIN
3.	ECHO AVG	OFF	0.5 1 2 3	3.	ECHO AVG	OFF	0.5 1 2 3	3.	ECHO AVG	OFF	0.5 1 2 3
4.	INT REJ	OFF	1 2 3	4.	INT REJ	OFF	1 2 3	4.	INT REJ	OFF	1 2 3
5.	STRETCH	OFF	1 2	5.	STRETCH	OFF	1 2	5.	STRETCH	OFF	1 2
6.	N REJ	OFF	ON	6.	N REJ	OFF	ON	6.	N REJ	OFF	ON
7.	ENHANCE	OFF	ON	7.	ENHANCE	OFF	ON	7.	ENHANCE	OFF	ON
8.	CONTRAST	1	2 3	8.	CONTRAST	1	2 3	8.	CONTRAST	1	2 3
9.	A/C AUTO	OFF	ON	9.	A/C AUTO	OFF	ON	9.	A/C AUTO	OFF	ON
0.	PULSE			0.	PULSE			0.	PULSE		

Above does not mean the optimum setting, but just for explanation.

4. Press the [2] key several times to select function desired.
5. Press the [ENTER/SELECT] key. The settings of items 3-9 automatically change according to selection made at step 4.
6. Press the [MENU] key.

1.34.2 Activating/deactivating a function

Press the [FUNCTION] key. Each time the key is pressed a preset function the preset functions enabled on the FUNC menu are turned on or off cyclically.

You may enable/disable preset functions from the menu as follows:

1. Press the [MENU] key followed by the [6] key twice to display the FUNC menu.
2. Press the [1], [2] or [3] key to enable or disable a preset function as appropriate.
3. Press the [ENTER/SELECT] key to register your selection and the [MENU] key to close the menu.

The picture setup options assignable to any of the function keys are shown in the table below:

LABEL	DESCRIPTION	LABEL	DESCRIPTION
BUOY	Optimum setting for detecting navigation buoys, small vessels and other small surface objects	RAIN	Setting for radar operation in rainy condition
OCEAN	Transoceanic voyage using a range scale of 12 nm or larger	LONG	Optimum setting for long range detection using a range scale of 6 nm or larger
COAST	For coastal navigation using a range of 12 nm or less	HARBOR	Optimum setting for short range navigation in a harbor area using a range scale of 1.5 nm or less
ROUGH SEA	Optimum setting for rough weather or heavy rain	FLOAT	Optimum setting for detecting the floating buoys of seine net

Function keys default settings are as below:

LABEL	3 ECHO AVG Echo Average	4 INT REJ Interference rejector	5 ECHO STRETCH Echo Stretch	6 NOISE REJ Noise Rejector	7 ENHANCE Enhance Video	8 CONTRAST Video Contrast	9 A/C AUTO A/C Auto
COAST	0.5	1	OFF	OFF	OFF	2	OFF
OCEAN	0.5	1	OFF	OFF	OFF	2	OFF
R-SEA	1	1	OFF	OFF	OFF	2	OFF
FLT	1	1	OFF	OFF	OFF	2	ON
BY	3	1	2	ON	OFF	3	OFF
HBR	0.5	1	OFF	OFF	OFF	2	OFF
L	3	1	1	ON	OFF	3	OFF
RAIN	0.5	1	OFF	OFF	OFF	2	OFF

1.35 Adjusting Brilliance of Screen Data

You can adjust relative brilliance levels of various marks and alphanumeric readouts displayed on the screen as follows:

1. Press the [MENU] key.
2. Press the [9] key twice to show the BRILL menu.
3. Select a desired menu item by pressing the corresponding numeric key. As an example, press the [1] key if you want to change the brilliance of target trails.

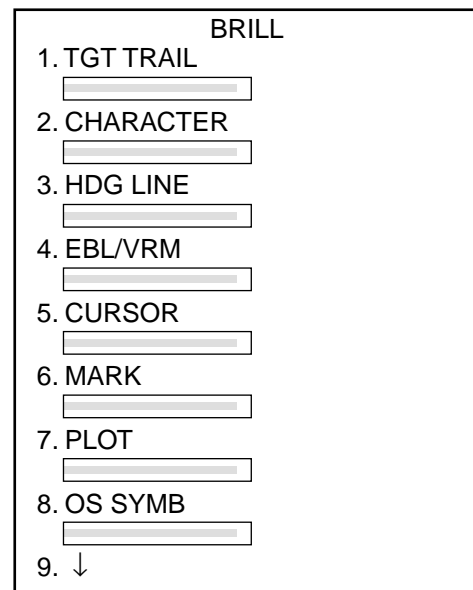

Menu item No. 9 requires RP-17 board

4. Operate the VRM rotary control to adjust brilliance. Current brilliance level is displayed by the bar-graph beneath each menu item.
5. Press the [ENTER /SELECT] key conclude your selection followed by the [MENU] key to close the menu.

1.36 Echo Stretch, Contrast, Enhanced Video

On long ranges target echoes tend to shrink in the bearing direction, making them difficult to see. On short and medium ranges such as 1.5, 3 and 6 nm scales, the same size targets get smaller on screen as they approach the own ship. These are due to the inherent property of the radiation pattern of the antenna. To enhance target video, use the echo stretch function. There are two types: echo stretch 1 (ES1) to enlarge in bearing direction for long range detection, and echo stretch 2 (ES2) to enlarge in range direction on 1.5-6 nm scales.

1.36.1 Echo stretch

1. Press the [F1] key.
2. Press the [4] key twice to display the ECHO SIG menu.
3. Press the [4] key to select echo stretch function desired. A selected level appears at the lower left-hand position. Each selection works as in the figure below.

1.	VECTOR	T/R
2.	PULSE	
3.	INT REJ	
4.	STRETCH	
5.	ECHO AVG	
6.	CONTRAST	
7.	N REJ	
8.	DISP SEL	
9.	PM	
0.	SART	

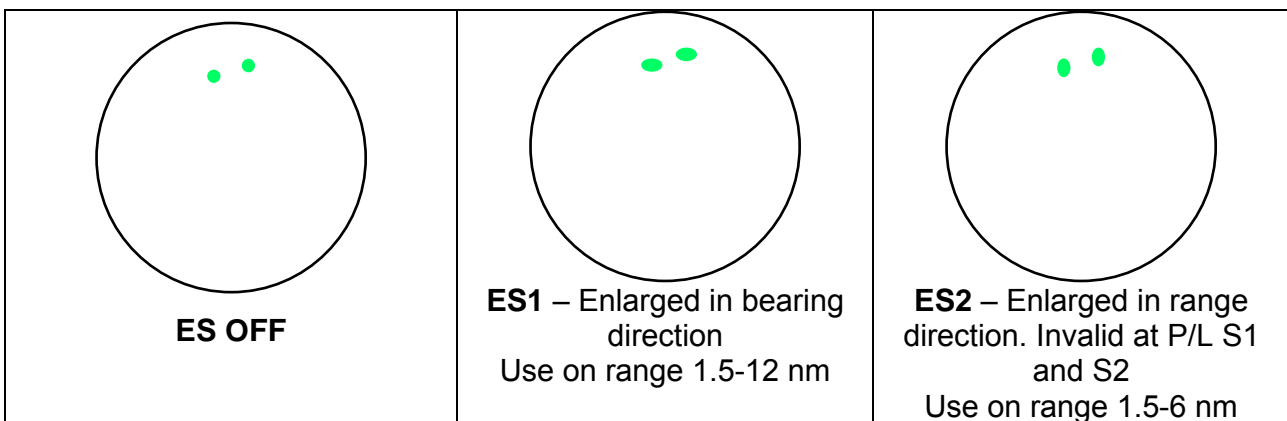

Notes:

- 1) If the 1.5 nm range is preset for pulselength of S1 or S2, and the 3 nm scale for S2, the echo stretch is not available on those range scales.
- 2) The echo stretch magnifies not only small target pips but also returns (clutter) from sea surface, rain and radar interference. For this reason make sure these types of interference have been sufficiently suppressed before activating this function.

1.36.2 Contrast

Contrast is adjustable in 3 levels according to the radar video sampling level. Press [F1], [6] and select the level so that the picture shows up most clearly from the background.

1.36.3 Enhanced video

The enhanced video function works similar to the echo stretch function, enlarging target echoes in bearing and range direction on 1.5-6 nm scales.

		ECHO SIG		
1.	COLOR	YEL	GRN	*
2.	CLTR SWEEP	OFF	ON (LINK)	ON(FIX)
3.	SWEEP LEVEL	1	2	3
4.	ENHANCE	OFF	ON	
5.	2ND ECHO	OFF	ON	
6.	PULSE 1			
7.	PULSE 2			
8.	A/D CURVE	A	B	C D
9.	CNTR ENHANCE	OFF	ON	
0.	REALTIME HU	OFF	ON	

* Color available on R-type.

8., 9., 0. R-type only.

1. Press the [MENU] key followed by the [5] key twice to show the ECHO SIG menu.
2. Press the [4] key to select OFF or ON from the ENHANCE field as appropriate.
3. Press the [ENTER/SELECT] key, and then press the [MENU] key.

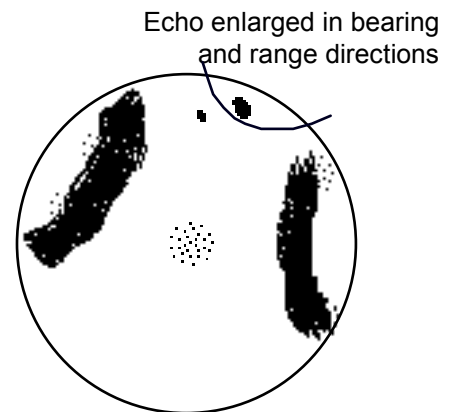

1.37 Watch Timer

The watch timer works like an alarm clock, sounding visual WATCH and audible alarms at a predetermined interval.

To silence the alarm, press the [AUDIO OFF] key. The label WATCH turns to normal color and the alarm timer is reset to the initial and starts the count-down sequence again.

To activate the timer:

1. Press the [MENU] key followed by the [4] key twice to select WATCH TIME.

WATCH TIME	
1. ALM INTVL	OFF 3min 6min 12min 15min 20min

2. Press the [1] key to select desired interval (3, 6, 12, 15, 20 min) from the ALM INTVL field.
3. Press the [ENTER/SELECT] key to conclude your selection followed by the [MENU] key to close the menu.

1.38 Noise Rejector

The noise rejector suppresses white noise, which appears on the screen as many dots scattered randomly over the display.

To suppress white noise:

1. Press the [F1] key.
2. Press the [7] key to turn the noise rejector on or off as appropriate. NR appears at lower left-hand position when the noise rejector is on.

1.39 Navigation Data

Various navigation data can be displayed (and their format selected) with connection of appropriate external sensors. You can select which navigation data to display as follows:

1. Press the [MENU] key, and then the [0] key twice to show the OTHERS menu.
8. Press the [8] key twice to select display the NAV DATA menu.
9. Press appropriate numeric key to turn data on/off, select format. You may select navigator (GPS, Loran C), position display format (L/L, TD, none), unit of depth measurement (meters, feet, fathoms), unit of water temperature measurement (°C, °F), display local time, and turn external waypoint on/off. Note that TDs are input from a Loran C navigator and are for display only.
4. Press the [ENTER/SELECT] key, and then press the [MENU] key.

1.40 Alarm Output (R-type only)

Alarm signal can be output on the R-type radars.. Select the alarm(s) to output as follows. Requires connection of external buzzer (OP03-21) to J212 on the SPD Board.

1. Press the [MENU] key.
2. Press the [0] key twice.
3. Press the [0] key twice again to select the sub menu OTHER.

OUTPUT ALM		
1. ↑		
2. TIMER	OFF	<input type="checkbox"/>
3. TGT ALM	OFF	<input type="checkbox"/>
4. ATA/EPA	OFF	<input type="checkbox"/>
5. PLOTTER	OFF	<input type="checkbox"/>

4. Press the [4] key twice to select OUTPUT ALM.
5. Press appropriate numeric key to select the alarm you want to output.
6. Press the [ENTER/SELECT] key followed by the [MENU] key.

1.41 Outputting Target Position (R-type only)

Target position can be output (in IEC 61162-1 format) to a video plotter and marked on its screen with a symbol. Select target with the trackball and push the A/C RAIN control. Target position is output to the video plotter connected to the NAV connector on the SPU Board inside the radar display unit. This function requires position data and compass signal.

1.42 Degaussing Interval

The screen is degaussed automatically at certain time intervals, as well as each time the radar is turned on, to eliminate color contamination caused by earth's magnetism or magnetized ship structure. You can select the degaussing interval and the degaussing degree as follows:

1. Press the [MENU] key followed by the [0] key four times to select OTHERS.
10. Press the [3] key to display the DEGAUSS menu.
11. Press the [2] key to select desired degaussing interval (OFF, 30 seconds, 1, 2 minutes) in the DEGS INTVL field.
12. Press the [3] key to select desired degaussing degree (45°, 90°, 135°) in the DEGS DEG field. For example, selecting 45° will automatically degauss the screen when the ship makes a turn which is between 45° and 89°.
5. Press the [ENTER/SELECT] key followed by the [MENU] key.

DEGAUSS					
1.	↑				
2.	DEGS INTVL	OFF	30 sec	1	2 min
3.	DEGS DEG	OFF	45°	90°	135°

1.43 Background Color

The [BKGND COLOR] key selects the color of the background, characters, menu, markers and indications as below. Each press of the key selects one of five color combinations.

Marks	Setting				
	1	2	3	4	5
Radar display area	BLK (black)	L-BLU (light blue)	L-BLU (light blue)	L-BLU (light blue)	BLK (black)
Outside radar display area	BLK (black)	BLK (black)	BLK (black)	L-BLK	BLK (black)
Characters	GRN (green)	GRN (green)	GRN (green)	WHT (white)	RED
Menu	YEL (yellow)	YEL (yellow)	YEL (yellow)	YEL (yellow)	YEL (yellow)
Menu highlight	YEL	YEL	YEL	YEL	RED
EBL/VRM	BLU (blue)	GRN (green)	GRN (green)	GRN (green)	L-BLU (blue)
Range rings	GRN (green)	WHT (white)	WHT (white)	WHT (white)	GRN (green)
Cursor	WHT (white)	GRN (green)	GRN (green)	GRN (green)	WHT (white)
Heading line	GRN (green)	WHT (white)	WHT (white)	WHT (white)	GRN (green)
Target alarm zone	WHT (white)	L-BLU (blue)	L-BLU (blue)	L-BLU (blue)	WHT (white)
North mark	GRN (white)	WHT (blue)	WHT (blue)	WHT (blue)	GRN (white)
Stern marker	GRN (white)	WHT (blue)	WHT (blue)	WHT (blue)	GRN (white)

1.44 Clutter Sweep

The clutter sweep feature suppresses sea and rain clutters within the trackball-selected area, to discriminate specific targets from noise. The user may select the area to process and the level of suppression to apply as follows:

1. Press the [MENU] key.
2. Press the [5] key twice to select the ECHO SIG menu.

3. Press the [2] key to turn on/off the clutter sweep function:
OFF: Turns off clutter wiper feature.
ON(LINK): Sweep area moves with trackball operation. Sweep cursor shown by dashed lines.
ON(FIX): Sweep area is fixed on the screen. Sweep cursor shown by solid lines.
4. Press the [3] key (SWEEP LVL) several times to select level of suppression to use; "3" provides the highest level of noise suppression.
5. Press the [ENTER/SELECT] key to register your selection and the [MENU] key to finish.
6. Operate the trackball to select area to process.

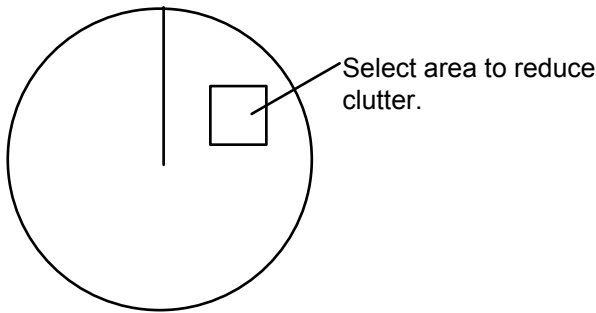

The clutter sweep feature may also be activated by the [F2] key.

1.45 Day, Night Brilliance

Press the BRILL control for day or night use; the whole screen is brightened or dimmed. This function has no effect on panel illumination.

1.46 Contrast

The contrast of video is adjustable in three levels according to the radar video sampling level. Select the level so that the radar picture shows up most clearly from the background.

1. Press [F1].
2. Press the [6] key to select desired contrast level from the CONTRAST field. Selected level is indicated as CONTRAST1, CONTRAST2 or CONTRAST3 at the lower-left corner on the screen.
3. Press the [MENU] key to finish.

1.47 Radar Map (RP-17 or RP-180 required)

A radar map is a combination of map lines and symbols whereby the user can define and input the navigation data, route planning and monitoring data. **Map lines** (also called nav lines) are navigational facility whereby the observer can define lines to indicate channels or traffic separation schemes. These lines can be ground stabilized to stop them from drifting. (Definition in IEC 60936-1 and IEC 60872-1)

In this series of radar, the standard radar map has the capacity of 3,000 points of mark and line. The map data can be memorized to facilitate the repeated use on the routine navigation area.

The user can create a radar map on-real time while using the radar for navigation or at leisure time at anchor or while the radar is not being used. Place of a map can be made for any waterways apart from the actual own ship location. The map data is stored in the memory. When the optional RP-17 card is installed in the display unit, much more data can be created and copied to another card.

1.47.1 Preparation

Selecting navaid

1. Press the [MENU] key.
2. Press the [0] key twice.
3. Press the [8] key twice again to display the NAV DATA menu.
4. Press [2] key to select navigation data input device.
5. Press the [ENTER/SELECT] key to register your selection and the [MENU] key to close the menu.

Notes:

- 1) Own ship position display requires an input from radionavigational equipment such as a GPS receiver in accordance with the data format as defined by IEC 61162-1.
- 2) Wind, ocean current, depth, water temperature are displayed when the relevant sensors are fitted and the data from these may be used to influence other data such as set/drift.

Displaying external waypoint

Waypoint defined on another navaid can be displayed by setting EXT WP to ON on the NAV DATA menu. This can be done by the keying sequence of MENU, [0], [0], [8], [8], [3].

Note: When the waypoint is more than 5000 nm away from own ship, the data shows > 5000 nm.

1.47.2 Making a radar map















Mark entry

Marks can be entered in three different ways.

1. Press the [MENU] key and the [8] key twice to display the MARK menu.
2. Press the [4] key to select the entry mode: Cursor, L/L or OS Position. For L/L, key in position with the numeral keys. Use + or – to specify N/E or S/W. Marks can be entered at OS position only when menu is displayed.
3. Press the [ENTER/SELECT] key.
4. Press the [1] key and key in mark to enter with the ten keys.
5. Press the [ENTER/SELECT] key.
6. Press the [MARK] key to enter mark.
7. Repeat step 6 to continue entering the same mark with the same entry method. To enter a different mark or change mark entry method, repeat above procedure. The map is automatically stored in the radar's memory.

Example: How to draw a coastline by cursor

1. Press the [MENU] key and the [8] key twice to display the MARK menu.
2. Press [1] [1] [7] (for coastline mark) and press the [ENTER/SELECT] key.
3. Press the [4] key to select Cursor and press the [ENTER/SELECT] key.
4. Press the [MENU] key.
5. Place the cursor mark on a required position and press the [MARK] key.
6. Place the cursor at a next position and press the [MARK] key. One line appears connecting designated two points.
7. Repeat step 6 to establish the coastline.

1.Mark Selection	
01 	02 
03 	04 
05 	06 
07 	08 
09 	10 
11 	12 
13 	14 -
15 ---	
16 Nav Line ---	
17 Coastline -	
18 Depth Contour ---	
19 Prohibited Area 	
20 Cable 	
21 Erase	
2.Display	
<input type="checkbox"/> On	Off
3.Erase	
<input type="checkbox"/> No	
	Erase Display
	Erase All
4.Entry method	
<input type="checkbox"/> Cursor	
	L/L
	OS Position
	00°00.000'N
	000°00.000'E
5.Posiiton Correction	
Mark in use	
	0/3000

1.47.3 Position and bearing correction

There may be some instances where the map latitude and longitude are out of radar pictures for several seconds. You can compensate this error as follows:

1. Press the [MENU] key.
2. Press the [8] key twice to display the MARK menu.
3. Press the [5] key to display the Position Correction menu.

Position Correction

1. ↑
2. Position Corr.
 No Yes
3. Delta L/L Entry
4. Variation Corr.
 Off Manu. Auto
5. Manual Entry

Delta L/L
000. 0'S
000. 0'W

Manual $\Delta\theta$
000. 0°W

Auto $\Delta\theta$
000. 0°W

Note: Variation Corr. and correction values appear only when a magnetic compass is connected.

4. For position correction, press the [2] key to select Yes from the Position Corr field and press the [ENTER/SELECT] key.
5. Press the [3] key to select Delta L/L Entry and press the [ENTER/SELECT] key.
6. Use the trackball to shift chart data.
7. Press the [ENTER/SELECT] key.
8. For bearing correction, press the [4] key to select Manu. from the Position Corr field, and then press the [ENTER/SELECT] key.
9. Press the [5] key to select Manual Entry and press the [ENTER/SELECT] key.
10. Use the EBL or VRM control to rotate chart data.
11. Press the [ENTER/SELECT] key followed by the [MENU] key.

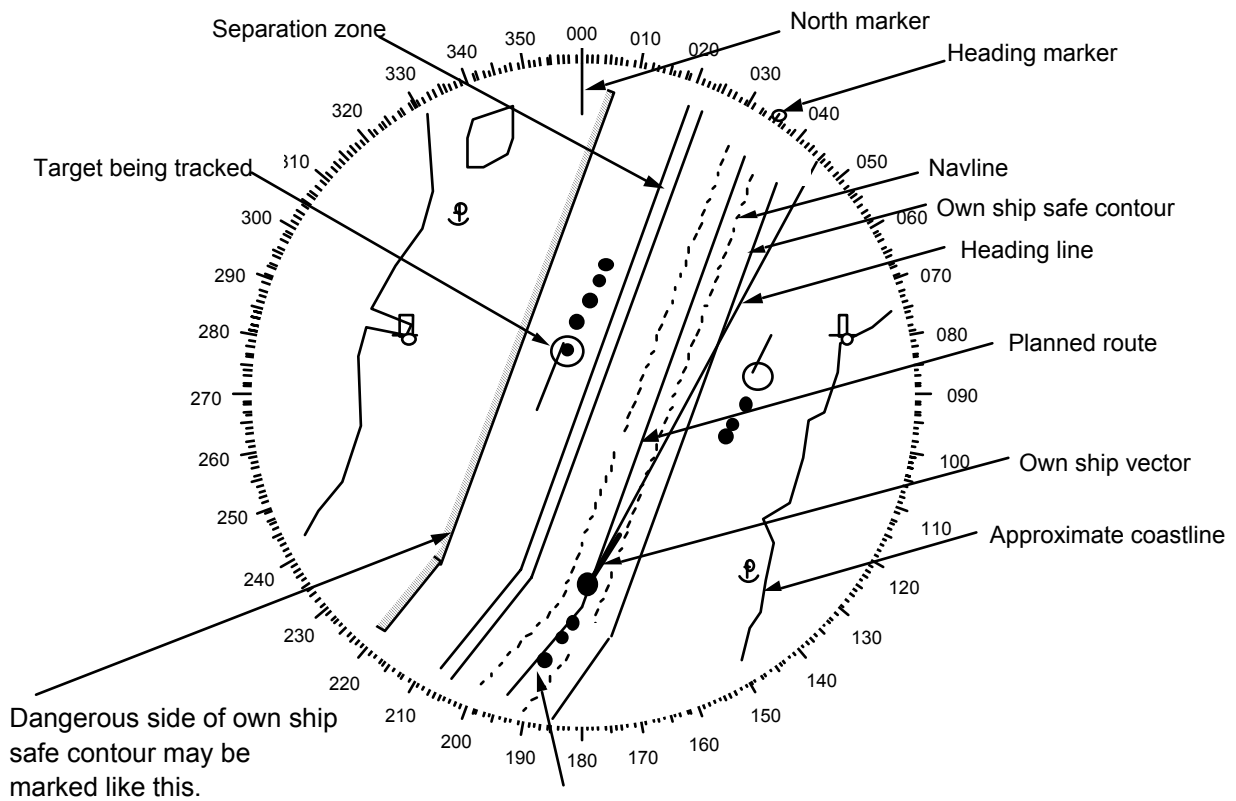

Past position
 ATA: Equally time-spaced positions of any targets being tracked.
 EPA: Past plot positions may not be equally time-spaced, up to the operator. Targets not plotted over 10 min will be dropped.

1.47.4 Displaying the radar map

1. Press the [MENU] key to display the Main menu.
2. Press the [8] key twice to display the MARK menu.
3. Press the [2] key to select ON from the DISP field.
4. Press the [ENTER/SELECT] key followed by the [MENU] key.

1.47.5 Erasing contents of the radar map

1. Press the [MENU] key.
2. Press the [8] key twice to display the MARK menu.
3. Press the [3] key 2-3 times to select the method of erasure: NO (individual marks), DISPLAY (marks currently displayed), or ALL (all marks).
4. Press the [ENTER/SELECT] key followed by the [MENU] key.

1.48 Alarms

The table below summarizes alarms which may occur at various warning conditions.

Warning	Audible alarm	Visual alarm	To quit alarm status
HEADING failure	2 beeps	HDG label reads xxx.x° and the message GYRO SIG MISSING appears in red. Display is automatically switched to head-up mode within 1 min. When the heading signal from the gyrocompass restores normal, the indication HDG SET appears in red.	Match the on-screen HDG readout with the actual compass reading, if necessary. To stop the audible alarm press the AUDIO OFF key. Press the MODE key to erase HDG SET and correct the heading readout.
Target alarm (TAZ)	Beeps	Target flashes.	Press [TARGET ALARM] key.
WATCH alarm	Beeps	WATCH 0:00 (Label WATCH TIM turns red and time count freezes at 0:00).	Press the [AUDIO OFF] key. The label WATCH turns to normal video and the timer is reset.
Own ship lat/lon Cursor lat/lon	None	xxx.x° In own ship position field xxx.x° In cursor position field	Make sure that own ship position data is fed from external radionav equipment.
System failure	None	Message AZIMUTH SIGNAL MISSING appears. No radar echoes.	
Incorrect keystroke	Double beep tone	None	Correct keystroke creates a single beep provided that KEY BEEP ON is selected in initial settings.
Log failure	2 beeps	LOG xx.x and LOG SIGNAL MISSING appear, if a log signal is absent for 30 sec while an os speed has been > 5.0 kt.	If the SDME has failed, use the Manual Speed mode or other appropriate sensor.
EPFS failure	Continuous beep	EPFS in red (EPFS: electronic position-finding system) The indication also appears when the GPS mode is switched between GPS and DGPS.	To silence the beep, press the [AUDIO OFF] key.
TRUE VECTOR indication	None	TRUE VECTOR (red) appears in the second data cell when the presentation mode is RM, goes off in the North-up TM.	
UPDATE PLOT	None	If you have failed to enter a next EPA plot within 10 min, this indication flashes. Plot symbol of the target also flashes.	Re-acquire the flashing target within 5 min. Leave it if it is not important.
COLLISION	Continuous beep	COLLISION comes on when EPA- or ATA-tracked target is on collision course.	Take evasive action or terminate tracking of target. Then, visual indication goes off.

General Warning	Beep or may not beep	<p>Corresponding labels turn red on the SIGNAL MISSING cell.</p> <p>TRIG: no trigger signal from the scanner unit.</p> <p>AZIMUTH: no azimuth signal (turning signal). See SYSTEM FAILURE column.</p> <p>VIDEO: no video signal from the RF transceiver.</p> <p>GYRO: no gyrocompass signal due to disconnected lines(s).</p> <p>LOG: see LOG FAILURE column.</p>	
CPU	None	LEDs light on the processor board 03P9230.	<p>Call a service representative.</p> <p>Note: US Regulation prohibits unqualified person to open the covers.</p>

1.49 Enlarging Close-in Targets (R-type only)

All targets within the first range ring can be enlarged as follows:

1. Press the [MENU] key to open the menu.
2. Press the [5] key twice to display the ECHO SIG menu.

ECHO SIG				
1. COLOR	YEL	GRN	*	
2. CLTR SWEEP	OFF	ON (LINK)	ON(FIX)	
3. SWEEP LEVEL	1	2	3	
4. ENHANCE	OFF	ON		
5. 2 ND ECHO	OFF	ON		
6. PULSE 1				
7. PULSE 2				
8. A/D CURVE	A	B	C	D
9. CNTR ENHANCE	OFF	ON		
0. REALTIME HU	OFF	ON		

*Color available on R-type

8., 9., 0. R-type only

3. Press the [9] key to select OFF or ON from the CNTR (Center) ENHANCE field as appropriate.
4. Press the [ENTER/SELECT] key followed by the [MENU] key.

1.50 A/D Converter Curve Setting (R-type only)

You may select an A/D curve according to objective, referring to the table below. The default setting is A.

1. Press the [MENU] key to open the menu.
2. Press the [5] key twice to display the ECHO SIG menu.
3. Press the [8] to select desired curve referring to the table below.
4. Press the [ENTER/SELECT] key followed by the [MENU] key.

A	A lot of green but little red. Noise is green in color.	Float detection. Reduce sea reflections. General navigation.
B	Between A and C.	Normal use: Useful for target discrimination.
C	Little green but lot of red. Fine noise. Noise in yellow and red.	Long range detection. Buoy detection.
D	Little green but lot of red. Fine noise. Noise in red.	Long range detection. Buoy detection. Longer range detection than C

1.51 Echo Area (R-type only)

You may select the size of the area in which echoes are displayed as follows:

1. Press [MENU], [0], [0], [5], [5] to show the DISPLAY menu.

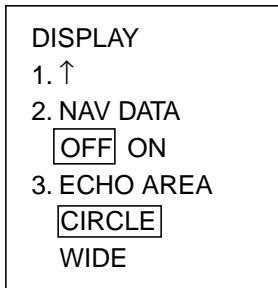

2. Press the [3] key to select CIRCLE or WIDE referring to the illustration below.

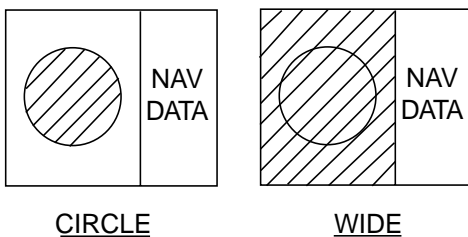

3. Press the [ENTER/SELECT] key followed by the [MENU] key.

1.52 Real Time Heading Up (R-type only)

The real time picture on the head-up mode can be displayed (default setting). If you prefer traditional picture to the real time picture, select it as follows.

1. Press the [MENU] key to open the menu.
2. Press the [5] key twice to display the ECHO SIG menu.
3. Press the [0] key to select OFF or ON from the REALTIME HU field as appropriate.
4. Press the [ENTER/SELECT] key followed by the [MENU] key.

This page is intentionally left blank.

2 OPERATION OF AUTOMATIC TRACKING AID (ATA) ARP-17

2.1 Introduction

The FR-1500 MARK-3 series radar can accommodate an optional ATA (Automatic Tracking Aid) module complying with IMO MSC.64(67) Annex 4 and IEC 60872-2. With the optional ATA circuit board (ARP -17) fitted in the display unit, the radar will automatically acquire 10 targets coming into the acquisition area. Once a target is acquired automatically or manually it is automatically tracked within 0.2 to 32 nm, whether inside or outside the acquisition area.

Principal specifications

Auto tracking range: 0.1 - 32 nm, irrespective of range scale and acquisition range

Vector length: 0.5 sec., 1, 2, 3, 6, 12, 15, 30 min.

Orientation: True velocity or relative velocity

Stabilization: Sea or Ground stabilization

Motion trend: Displayed within 20 scans, full accuracy within 60 scans after acquisition.

Past positions: 10 past positions at intervals of 30 sec, 1, 2, 3 or 6 min.

Alarms: Visual and audible alarms against targets violating CPA/TCPA limits, lost targets, targets crossing guard zone, system failure and target full status.

ATA Menu tree

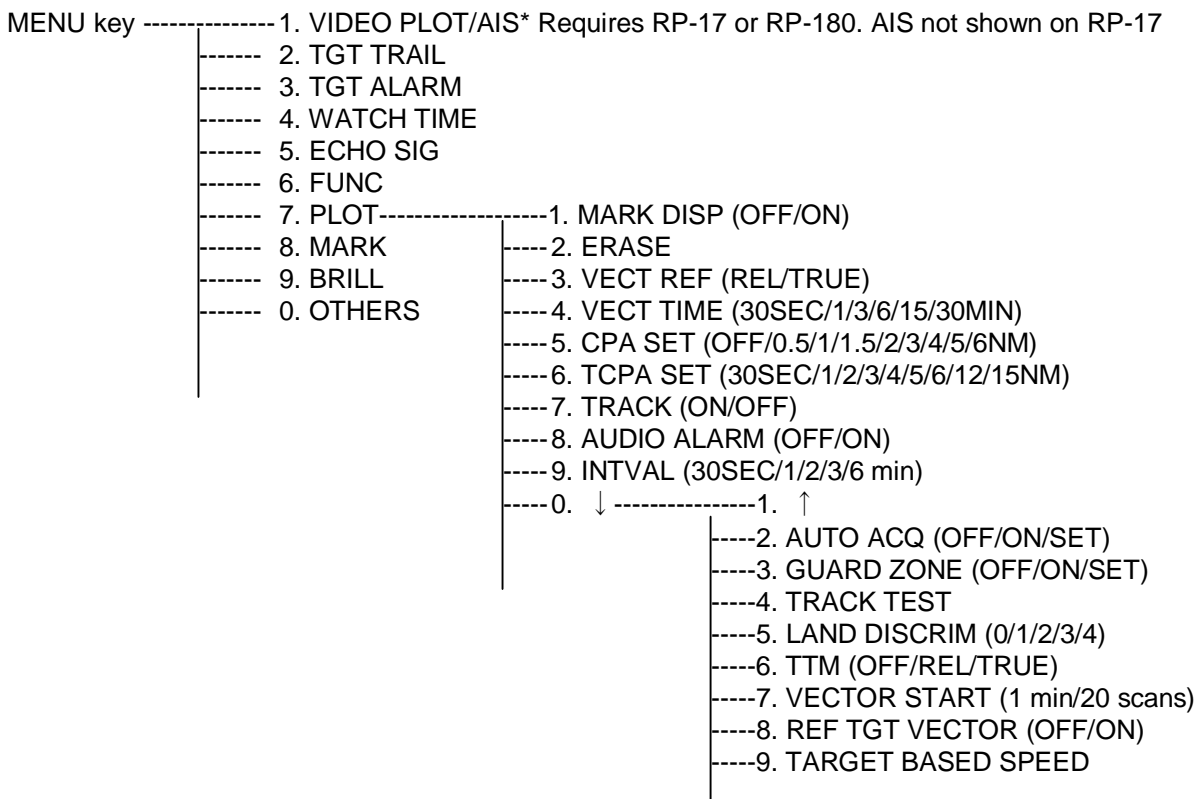

2.2 Criteria of Tracking

A target measuring 800 m or more in the radial or circumferential direction is regarded as a landmass and not acquired or tracked. Echoes smaller than 800 m are regarded as targets to be tracked.

The FURUNO ARPA ATA video processor detects targets in the midst of noise and discriminates radar echoes on the basis of their size. Target whose echo measurements are greater than those of the largest ship in range or tangential extent are usually land and are displayed only as normal radar video. All smaller ship-sized echoes which are less than this dimension are further analyzed and regarded as ships and displayed as small circles superimposed over the video echo.

When a target is first displayed, it is shown as having zero true speed but develops a course vector as more information is collected. In accordance with the International Marine Organization Automatic Radar Plotting Aid (IMO ARPA) requirements, an indication of the motion trend should be available within 20 scans of antenna and full vector accuracy within 60 scans. The FURUNO ARPAs/ATAs comply with these requirements.

Acquisition and tracking

A target which is hit by 5 consecutive radar pulses is detected as a radar echo. Auto acquisition is not defined in paints but in time, which should be less than 3 seconds of initial stage.

Manual acquisition is done by designating a detected echo with the trackball. Automatic acquisition is done in the acquisition areas when a target is detected 5-7 times continuously depending upon the congestion. Tracking is achieved when the target is clearly distinguishable on the display for 5 consecutive or alternate paints out of 10 consecutive scans whether acquired automatically or manually. Required tracking facilities are available within 0.1-32 nm on range scales including 3, 6, 12 nm; full plotting information is available within one scan when the range scale has been changed. Targets not detected in 5 consecutive scans become "lost targets".

Quantization

The entire picture is converted to a digital form called "Quantified Video". A sweep range is divided into small segments and each range element is "1" if there is radar echo return above a threshold level, or "0" if there is no return.

The digital radar signal is then analyzed by a ship-sized echo discriminator. As the antenna scans, if there are 5 consecutive radar pulses with 1's indicating an echo presence at the exact same range, a target "start" is initiated. Since receiver noise is random, it is not three bang correlated, and it is filtered out and not classified as an echo.

The same is true of radar interference. Electronic circuits track both the closet and most distant edges of the echo. At the end of the scanning of the echo, the discriminator indicates the measured maximum range extent and total angular extent subtended by the echo. If the echo is larger than a ship-sized echo in range extent and/or angular width, adjusted as a function of range, it is declared to be a coastline and the closet edge is put into memory as a map of the area.

This land outline is used to inhibit further acquisition and tracking of ship sized echoes beyond the closest coast outline. 5 consecutive scans of coastal outline are retained in memory to allow for signal variation. All smaller echoes are declared to be ship sized and the middle of the leading edge is used to provide precise range and bearing coordinates of each echo on every scan. This range/bearing data is matched to previous data and analyzed from scan-to-scan for consistency. When it is determined to be as consistent as a real target, automatic acquisition occurs and tracking is initiated.

Continued tracking and subsequent calculation develop the relative course and speed of the target just as a man would do when plotting the relative course and speed of the target on the scope with a grease pencil.

The true course and speed of own ship are computed from own ship's gyro and speed inputs, and the resulting course and speed of each tracked target is easily computed by vector summing of the relative motion with own ship's course and speed. The resulting true or relative vector is displayed for each of the tracked targets. This process is updated continually for each target on every scan of the radar.

Automatic acquisition areas and suppression lines

Performance of auto-acquisition is enhanced by controlling the limit lines (suppression lines) in the former series of FURUNO ARPAs. In the ATA, the automatic acquisition rings are used instead of the limit lines.

Auto acquisition rings work as suppression lines when viewed from the opposite direction. They should be placed clear of a landmass or shoreline. The acquisition areas may be a full 360 degree circle or sector of any angles. They are gyro stabilized.

Qualitative description of tracking error

The FURUNO ARPA or ATA accuracy complies with or exceed IMO standards.

Own ship maneuvers

For slow turns there is no effect. For very high turning rates (greater than 150°/ minute, depending on gyro), there is some influence on all tracked targets which last for a minute or two and then all tracked targets revert to full accuracy.

Other ship maneuvers

Target ship courses, lag 15 to 30 seconds at high relative speed, or 3 to 6 seconds at low (near 0) relative speed. It is less accurate during a turn due to lag, but accuracy recovers quickly.

2.3 Activating, Deactivating the ATA

The ATA is activated/deactivated through the menu. Acquired targets are tracked internally when the ATA is deactivated.

1. Adjust the A/C RAIN, A/C SEA and GAIN controls for proper radar picture.
2. Press [MENU], [7] to show the PLOT MENU 1

PLOT MENU 1	
1. MARK DISP	OFF <input checked="" type="checkbox"/> ON
2. ERASE	
3. VECT REF	REL TRUE
4. VECT TIME	(min)
	30sec 1 3 6
	15 30
5. CPA SET	OFF 0.5NM 1NM
	1.5NM 2NM 3NM
	4NM 5NM 6NM
6. TCPA SET	(min)
	30sec 1 2 3 4
	5 6 12 15
7. TRACK	OFF ON
8. AUDIO ALARM	OFF ON
9. INTVAL (min)	30sec 1 2
	3 6

3. Press the [1] key to select ON or OFF from the MARK DISP field.
4. Press the [ENTER/SELECT] key.
5. Press the [MENU] key to close the menu.

2.4 Entering Own Ship's Speed

The ATA requires own ship's speed and heading data. Of these, the speed data can be entered automatically from a speed log, navaid or manually through the menu.

Note: It is customary to use a speed relative to water for collision avoidance and a speed over the ground for navigation purpose.

2.4.1 Automatic speed input

1. Press [MENU], [0], [0] to display the OTHERS menu.

```

                OTHERS
1. HDG SET
2. SPD MODE      MAN  LOG
                  LOG (S-BT)
                  LOG (S-WT)
3. MAN SPD
4. SET & DRIFT
5. DISPLAY
6. MARK/LINE
7. TUNE
8. NAV DATA
9. EBL+/PI
0. ↓
```

2. Press the [2] key to select LOG or NAV (R-type only) from the SPD MODE field.
3. Press the [ENTER/SELECT] key.
4. Press the [MENU] key to close the menu.

Notes:

- 1) IMO Resolution A.823(19) for ARPA recommends that a speed log to be interfaced with an ARPA should be capable of providing through-the-water speed. This applies to the ATA as well.
- 2) Be sure not to select LOG when a speed log is not connected. If the log signal is not provided, the ship's speed readout at the screen top will be blank.
- 3) SPEED xx.x and SIGNAL MISSING "LOG" appears if no log signal is present for 30 seconds while the ship speed has been more than 5.0 kt.

2.4.2 Manual speed input

Select MAN at step 2 in preceding procedure, press the [3] key twice, and enter a speed with numeral keypads.

Target-based speed input

This mode is used when the ship's SDME (log) is not operating properly or the vessel has no device which detects ship's leeward movement (Doppler sonar 2-axis speed log, etc.) and leeward movement is not disregarded.

If you select target-based speed, the radar calculates own ship's speed relative to fixed reference targets. The number of targets may be 1, 2 or 3. They appear as tracked targets, each shown in a small circle, but without a vector. When a plural of reference targets are selected, the mean value is used for stabilization and speed. A vector can be displayed for the reference target. This can be done with REF TGT VECTOR on the PLOT menu 2.

1. Select a small ground mass target (small island, lighthouse) 0.2 to 24 nautical miles from own ship.
2. Place the cursor on the target.
3. Press [MENU], [7], [7], [0], [0], [9], [9].
4. Press the [MENU] key. The reference target mark (see below) appears at the cursor position and the own ship data label changes from "LOG," "NAV" or "MENU" to "REF." Note that it takes 60 scans before a new speed is displayed. If tracking has failed for a reference target, the target is marked with a lost target mark (symbol formed with two triangles).

 changes to  R in 60 scans

Reference targets are marked with a circle having a reference number (R1, R2, R3).

Note: Targets under automatic tracking condition **should not** be selected as reference Targets.

	PLOT MENU 2
1.	↑
2.	AUTO ACQ OFF ON SET
3.	GUARD ZONE OFF ON SET
4.	TRACK TEST OFF ON
5.	LAND DISCRIM 0 1 2 3 4
6.	TTM OFF REL TRUE
7.	VECT START 1min 20SCAN
8.	REF TGT VECTOR OFF ON
9.	TARGET BASED SPEED

2.5 Acquiring Targets

The ATA permits automatic acquisition (10 targets) plus manual acquisition (10 targets), or fully manual acquisition (20 targets) within a range of 0.2 to 32 miles. The targets are automatically numbered and the same numbers are not used more than once until the maximum capacity is reached.







Before starting the ATA, check that heading and speed readouts at the top of the screen are correct.

2.5.1 Manual acquisition

1. Place the cursor (+) on a target of interest by operating the trackball.
2. Press the [PLOT SYMBOL] key.

The plot symbol changes its shape according to the status as below. A vector appears in about one minute after acquisition, indicating the target's motion trend. If the target is consistently detected for three minutes, the plot symbol changes to a solid mark. If acquisition fails, the target symbol blinks and disappears shortly.

List of plot symbols

	Reference target under steady tracking condition
	20 scans of initial tracking
	60 scans of initial tracking (Steady tracking)
	Target selected for data readout
	CPA alarm
	Target in guard zone
	Lost target is indicated by flashing diamond symbol. The diamond is formed from two equal triangles. The lost target disappears after a while.



CAUTION - TARGET SWAP

When a target being tracked nears another target being tracked, the targets may be swapped. When two targets acquired either automatically or manually come close to each other, one of the two may become a Lost Target. Should this happen, manual re-acquisition of the Lost Target may be required after the two have separated.

2.5.2 Automatic acquisition

1. Press [MENU], [7], [7] to display the PLOT menu.
2. Press the [0] key twice.
3. Press the [2] key to select SET from the AUTO ACQ field.
4. Press the [ENTER/SELECT] key.
5. Place the cursor at upper (lower) left edge of area and press the [ENTER/SELECT] key.
6. Place the cursor at the lower (upper) right edge of the area and press the [ENTER/SELECT] key.

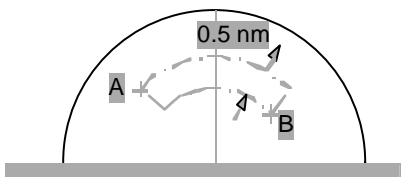

2.5.3 Changing plot symbol mark

The plot symbol for a target may be changed after acquiring the target. This feature is available on the R-type radar.

1. Place the cursor on the plot symbol mark you wish to change.
2. Press the [ENTER/SELECT] key successively while pressing and holding down the [HL OFF] control to select plot symbol mark desired.

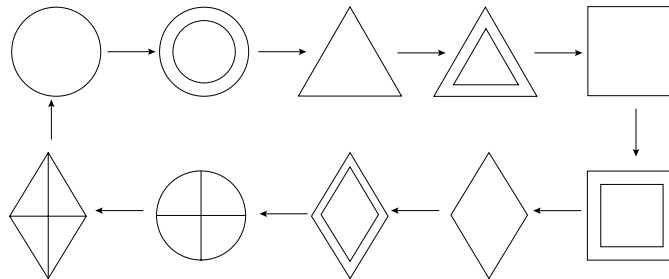

Plot symbols

Note: Changing the plot symbol mark while a target is under acquisition (target marked with dashed square) will cause all plot symbol marks above to be shown with dashed lines.

3. To inscribe a smaller plot symbol mark, place the cursor on any plot symbol, then press the [ENTER/SELECT] key. Mark size can be alternately selected to large or small by repeating this step.

2.6 Terminating Tracking of Targets

When the ATA has acquired 20 targets, no more acquisition occurs unless targets are lost. Should this happen, cancel tracking of individual targets or all targets by the procedure described below.

2.6.1 Individual targets

Place the cursor (+) on a target which you do not want to be tracked any longer by operating the trackball and press the [CANCEL/CLEAR] key.

2.6.2 All targets

All targets can be canceled from the PLOT menu as follows.

1. Press [MENU], [7], [7] to show the PLOT menu.
2. Press the [2] key twice to select ERASE.
3. Press the [ENTER/SELECT] key.
4. Press the [MENU] key.

2.7 Vectors True or Relative

Target vectors are displayed in relative or true mode. Own ship does not have a vector in relative mode. You may select true or relative vector with VECT REF on the PLOT MENU 1.

2.7.1 Vector time

From the PLOT MENU 1, VECT TIME (or the length of vectors) can be set to 30 seconds, 1, 3, 6, 15 or 30 minutes and the selected vector time is indicated on the screen.

The vector tip shows an estimated position of the target after the selected vector time elapses. It can be valuable to extend the vector length to evaluate the risk of collision with any target.

2.7.2 Vector start time

Whenever the range is changed the vectors for tracked targets is reestablished. You can select when to start re-establishment of the vectors with VECT START on the PLOT MENU 2. The operator has the choices of 1 min or 20 scans.

2.8 Displaying Target Data

The ATA calculates motion trends (range, bearing, course, speed, CPA and TCPA) of all targets under tracking, and displays data of selected target at the top right corner of the screen.

Note: At a speed under 5 kt the target data is displayed with a delay due to filtration processing.

Displaying data

Place the cursor on a wanted target and press the [ENTER/SELECT] key. Data on the selected target is displayed on the screen. The data includes the follows;

BRG/RNG (Bearing/Range): **RNG/BRG** (Range/Bearing): Range and bearing from own ship to the selected target with suffix T (True).

CSE/SPD (Course/Speed): Course and speed are displayed for the selected target with suffix T (True).

CPA (Closest Point of Approach) is the closest range a target will approach to own ship. Do not confuse it with the operator preset CPA alarm limit.

TCPA is the time to CPA measured with present speeds of own ship and the targets. Both CPA and TCPA are automatically calculated. When a target ship has passed clear of own ship, the CPA is displayed and the TCPA appears as “**.*” TCPA is counted up to 99.59 min. and beyond this it is indicated as TCPA>99.9 min.

Note 1: MARK DISP on the PLOT menu must be turned on to display target data.

Note 2: Target data may be displayed with reference to North (True) or own ship heading (Relative). The desired reference may be selected with TARGET DATA on the PLOT menu.

2.9 Past Position Display

The ATA displays equally time-spaced dots (maximum 10 dots at intervals of 30 seconds, 1, 2, 3 or 6 minutes) marking the past positions of any targets being tracked.

If a target changes its speed, the spacing will be uneven. If it changes the course, its plotted course will not be a straight line in TM mode. In True Motion, the past position display is produced relative to North (True Trails). In Relative Motion, it is relative to North or Heading as selected.

To turn the past position display on/off:

1. Press [MENU], [7], [7] to display the PLOT menu.
2. Press the [7] key to select ON or OFF from the TRACK field as appropriate.

Selecting plotting interval

On the PLOT MENU 1, select desired past position display plotting interval from the 9. INTVAL field.

2.10 Set and Drift

Set, the direction of ocean current, can be manually entered in the nearest degree. Drift, the speed of current, can also be entered manually, in 0.1 knot increments. Set and drift corrections are beneficial for increasing the accuracy of the vector data. The correction is best made on relative motion with true vector, watching landmasses, buoys, or stationary targets. Thus, the speed and course of own ship over the ground are reciprocally calculated and compared with the relative bearing and range to the reference target to produce a Set and Drift. These values are applied to all targets. If stationary objects have vectors, the set and drift should be corrected until they lose their vectors.

If own ship is equipped with a device to indicate ocean current movements, the values shown on it may be used.

1. Press [MENU], [0], [0] to display the OTHERS menu.
2. Press the [4] key twice to select SET & DRIFT.

SET & DRIFT	
1.	↓ ↑
2.	SET & DRIFT <input type="text" value="OFF"/> ON
3.	SET 000.0°
4.	DRIFT 00.0kt

3. Press the [2] key to select ON from the SET & DRIFT field, and then press the [ENTER/SELECT] key.
4. Press the [3] key, enter SET value, and then press the [ENTER/SELECT] key.
5. Press the [4] key, enter DRIFT value, and then press the [ENTER/SELECT] key.
6. Press the [MENU] key.

2.11 Alarms

2.11.1 CPA/TCPA alarm

Visual and audible alarms are generated when the predicted CPA and TCPA of any target become less than their preset limits.

The ATA continuously monitors the predicted range at the Closest Point of Approach (CPA) and predicted time to CPA (TCPA) of each tracked target to own ship.

When the predicted CPA of any target becomes smaller than a preset CPA alarm range and its predicted TCPA less than a preset TCPA alarm limit, the ATA releases an audible alarm. In addition, the target plot symbol changes to a triangle and flashes together with its vector.

Provided that this feature is used correctly, it will help prevent the risk of collision by alerting you to threatening targets. It is important that GAIN, A/C SEA, A/C RAIN and other radar controls are properly adjusted and the ATA is set up so that it can track targets effectively.

CPA/TCPA alarm ranges must be set up properly taking into consideration the size, tonnage, speed, turning performance and other characteristics of own ship.

The CPA/TCPA alarm feature should never be relied upon as a sole means for detecting the risk of collision. The navigator is not relieved of the responsibility to keep visual lookout for avoiding collisions, whether or not the radar or other plotting aid is in use.

Follow the steps shown below to set the CPA/TCPA alarm ranges:

1. Press [MENU], [7], [7] to display the PLOT menu.
2. Press [5] (CPA SET) to select CPA limit desired from the CPA SET line.
3. Press the [ENTER/SELECT] key.
4. Press [6] (TCPA SET) to select a TCPA limit desired.
5. Press the [ENTER/SELECT] key.
6. Press the [MENU] key to close the menu.

Silencing CPA/TCPA audible alarm

Press the [AUDIO OFF] key to acknowledge and silence the CPA/TCPA audible alarm.

The flashing of the triangle plot symbol and vector remain on the screen until the dangerous situation is no longer present or you intentionally terminate tracking of the target by using the [CANCEL/CLEAR] key.

2.11.2 Lost target alarm

When the system detects a lost target, tracking on the target is discontinued and the target symbol becomes a flashing diamond, finally disappearing from the display. The normal plotting symbol is restored to the target when the target is manually acquired.

Confirming lost target

1. Place cursor on target.
2. Press the [CANCEL/CLEAR] key.

2.11.3 Guard zone alarm

When a target comes in a guard zone, the audible alarm comes on with the visual indication GUARD ZONE. The intruding target is denoted by an inverted triangle mark. If the target leaves the zone, it changes to a normal tracking symbol (O).

You can set the guard zone as follows:

1. Press the [MENU], [7], [7] to display the PLOT menu.
2. Press the [0] key twice.
3. Press the [3] key to select GUARD ZONE.
4. Press the [3] key again to select SET and press the [ENTER/SELECT] key.
5. Set the cursor on one boundary of the guard ring and press the [ENTER/SELECT] key. Set the cursor on the other boundary and press the [ENTER/SELECT] key.

The default (setting at switching on) Guard Zone covers 3.5-4 nm in a sector $\pm 45^\circ$ of the heading. The range and sector of the GZ may be adjustable to cover full 360° as selected by the operator. To disable the guard zone, select OFF at step 4 in the above procedure and press the [ENTER/SELECT] key.

2.12 Track Test (Simulation Display)

Do this test when the radar is not being used.

The simulation display tests the ATA processor for proper operation. The figure below shows the starting picture of the simulation display. Each mark moves as time passes. Check that each target's data is reasonable.

1. Press [MENU], [7], [7], [0], [0], [4], [4].
2. Press the [ENTER/SELECT] key to start the test.
3. It takes approximately three minutes for all vectors to be displayed completely on the screen. The simulation display does not need radar, gyrocompass nor speed log input; seven targets on various courses and speeds are provided.

Target	Course	Speed (kt)	CPA (nm)	TCPA (min)
Target A	90.0°T	10.0	1.0	10.4
Target B	0.0°T	0.0	4.0	-
Target C	180.0°T	10.0	1.7	28.2
Target D	216.5°T	23.8	0.9	15.0
Target E	273.5°T	14.2	6.0	22.5
Target F	180.0°T	20.0	0.0	30.0
Target G	24.6°T	15.6	4.0	43.6

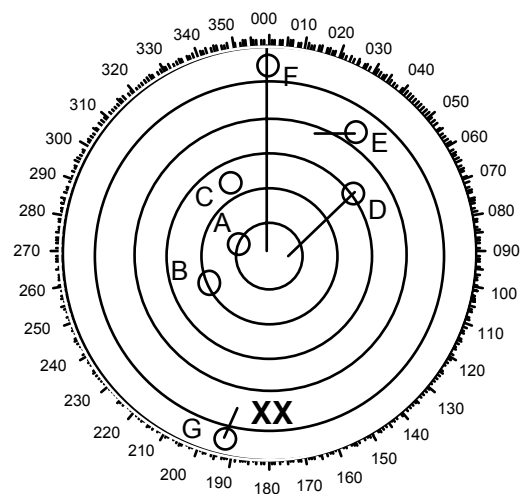

4. The simulation continues for five minutes and then repeats. To quit the test sequence, repeat step 1.

2.13 Outputting Target Data

Target data may be output to external equipment as follows:

1. Press [MENU], [7], [7], [0], [0].
2. Press the [6] key to select OFF, REL, TRUE from the TTM field as appropriate.
1. Press the [ENTER/SELECT] key followed by the [MENU] key.

2.14 Diagnostic Sequence

You can check the ATA Board for proper operation as follows. The self test does not require operator intervention. It runs automatically when the power is placed on at regular intervals or on operator demand.

1. Press [MENU], [0], [0], [0], [0].
2. Press the [2] key twice to start the diagnosis sequence. The results of the test appear as shown below.

FR-1500 M-3 TEST		
1. Program No.	03591521**	Press MENU key to escape.
2. ROM Check	OK	Press ENTER to check CRT.
3. RAM Check	OK	** = Program Version No.
4. Antenna Rotation	24rpm	
5. TX Trigger Frequency	3000Hz	
6. Video Level	000	
7. Video Signal	OK	
ARP TEST		
1. Program No.	18590411**	18590421**
2. ROM Check	OK	OK
3. RAM Check	OK	
4. Speed Log	OK	0.0KT
5. Course	OK	
6. Trigger	OK	
7. Video Signal	OK	
8. Bearing Pulse	OK	
9. Heading Pulse	OK	
10. Minimum Hit	OK	
11. Scan Time	0274	
12. Manual Acq	00	
13. Auto Acq	00	
14. FE-Data 1	0000	
15. FE-Data 2	0000	

If NG appears for any ATA-related item, call for service.

2.15 Factors Affecting ARPA Functions

Sea returns

If the radar anti-clutter control is adjusted properly, there is no serious effect because distant wave clutter, not eliminated by this control, is filtered out by more than one bang correlation and scan-to-scan matching of data.

Rain and snow

Clutter can be acquired and tracked as targets. Adjust the A/C RAIN control. If it is heavy rain, switch to S-band if provided, or switch on the interference rejector on the radar. If heavy clutter still exists, switch to manual acquisition. Accuracy can be affected.

Low clouds Usually no effect. If necessary, adjust the A/C RAIN control.

Non-synchronous emissions No effect.

Low gain

Insufficient or low radar receiver gain will result in some targets not being acquired at long distance. ARPA display will be missing on one or more targets that could only be visible if the radar sensitivity control (GAIN control) were increased.

The setting of the correct radar receiver gain is not critical but the target should be on the radar display area and be clearly visible and well defined.

Manual acquisition is done if a target is positively displayed more than once. Automatic acquisition is done when the target is detected 5-7 times continuously. Tracking is achieved when the target is detected 5 times (not necessarily continuously) out of 10 scans. If not detected 6 times out of 10 scans, the target will become a "lost target." The ARPA or ATA will acquire a radar echo that is present once in every six antenna scans and continue tracking if 1 in 10.

Second trace echoes

When the radar beam is super refracted, strong echoes may be received at such long ranges that they appear on a different timebase sweep than the transmitted pulse. This gives an incorrect range indication. Second and third trace echoes can be tracked if they are consistent enough to meet acquisition and tracking criteria but target course and speed data will be in error.

Blind and shadow sectors

Radar shadow or blind areas caused by obstructions aboard ship, for example, funnels and masts, in the path of the radar beam can result in reduction of radar beam intensity in that particular direction. This may eliminate the detection of some targets. The ARPA or ATA system will lose track of targets shortly after they are lost on the radar picture and if they remain in a blind zone. These targets will however be acquired and tracked when they pass out of the blind zone and again present normal radar echo. The angular width and bearing of any shadow sector should be determined for their influence on the radar. In certain cases false echoes in the shadow sector cause the ARPA or ATA system to acquire, track, and vector them. Shadow sectors should be avoided.

Indirect echoes

A target at close range is usually picked up directly, but it can also be received as reflection from a large, flat surface. This will result in the radar presenting two or more echoes on the display, each at a different range. The ARPA or ATA can acquire and track the false echo if it is detected by five consecutive scans. Reduction in radar GAIN can eliminate the multiple echoing but care should be taken as range detection also will be reduced.

Radar interference

If interference is extreme due to another radar operating at close range, spiral "dotting" and/or false targets may appear momentarily. The interference rejector can clear the display.

To receive radar beacon or SART signals, turn off the radar interference rejection and echo average which operate on the correlation technique.

3 RADAR OBSERVATION

3.1 General

Minimum range

The minimum range is defined by the shortest distance at which, using a scale of 1.5 or 0.75 nm, a target having an echoing area of 10 m² is still shown separate from the point representing the scanner position.

It is mainly dependent on the pulselength, scanner height, and signal processing such as main bang suppression and digital quantization. It is a good practice to use a shorter range scale as far as it gives favorable definition or clarity of picture. The IMO Resolution A. 477 (XII) and IEC 936 require the minimum range to be less than 50 m. All FURUNO radars satisfy this requirement.

Maximum range

The maximum detecting range of the radar, R_{max}, varies considerably depending on several factors such as the height of the scanner above the waterline, the height of the target above the sea, the size, shape and material of the target, and the atmospheric conditions.

Under normal atmospheric conditions, the maximum range is equal to the radar horizon or a little shorter. The radar horizon is longer than the optical one by about 6% because of the diffraction property of the radar signal. The R_{max} is given in the following equation.

$$R_{\max} = 2.2 \times (\sqrt{h_1} + \sqrt{h_2})$$

where R_{max}: radar horizon (nautical miles)
 h₁: scanner height (m)
 h₂: target height (m)

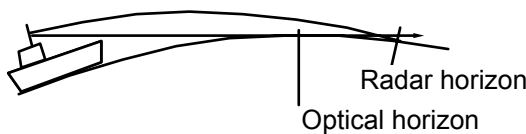

For example, if the height of the scanner above the waterline is 9 meters and the height of the target is 16 meters, the maximum radar range is;

$$R_{\max} = 2.2 \times (\sqrt{9} + \sqrt{16}) = 2.2 \times (3 + 4) = 15.4 \text{ nm}$$

It should be noted that the detection range is reduced by precipitation (which absorbs the radar signal).

X-band and S-band

In fair weather, the above equation does not give a significant difference between X- and S-band radars. However, in heavy precipitation condition, an S-band radar would have better detection than an X-band radar.

Radar resolution

There are two important factors in radar resolution (discrimination): bearing resolution and range resolution.

Bearing resolution

Bearing resolution is the ability of the radar to display as separate pips the echoes received from two targets which are at the same range and close together. It is proportional to the scanner length and reciprocally proportional to the wavelength. The length of the scanner radiator should be chosen for a bearing resolution better than 2.5° (IMO Resolution). This condition is normally satisfied with a radiator of 1.2 m (4 ft) or longer in the X-band. The S-band radar requires a radiator of nominal 12 feet (3.6 m) in our product range.

Range resolution

Range resolution is the ability to display as separate pips the echoes received from two targets which are on the same bearing and close to each other. This is determined by pulselength only. Practically, a 0.08 microsecond pulse offers the discrimination better than 35 m as do so with all FURUNO radars.

Test targets for determining the range and bearing resolution are radar reflectors having an echoing area of 10 m^2 .

Bearing accuracy

One of the most important features of the radar is how accurately the bearing of a target can be measured. The accuracy of bearing measurement basically depends on the narrowness of the radar beam. However, the bearing is usually taken relative to the ship's heading, and thus, proper adjustment of the heading line at installation is an important factor in ensuring bearing accuracy. To minimize error when measuring the bearing of a target, put the target echo at the extreme position on the screen by selecting a suitable range.

Range measurement

Measurement of the range to a target is also a very important function of the radar. Generally, there are two means of measuring range: the fixed range rings and the variable range marker (VRM). The fixed range rings appear on the screen with a predetermined interval and provide a rough estimate of the range to a target. The variable range marker's diameter is increased or decreased so that the marker touches the inner edge of the target, allowing the operator to obtain more accurate range measurements.

3.2 False Echoes

Occasionally echo signals appear on the screen at positions where there is no target or disappear even if there are targets. They are, however, recognized if you understand the reason why they are displayed. Typical false echoes are shown below.

Multiple echoes

Multiple echoes occur when a transmitted pulse returns from a solid object like a large ship, bridge, or breakwater. A second, a third or more echoes may be observed on the display at double, triple or other multiples of the actual range of the target as shown below. Multiple reflection echoes can be reduced and often removed by decreasing the gain (sensitivity) or properly adjusting the A/C SEA control.

Side lobe echoes

Every time the radar pulse is transmitted, some radiation escapes on each side of the beam, called "side lobes." If a target exists where it can be detected by the side lobes as well as the main lobe, the side echoes may be represented on both sides of the true echo at the same range. Side lobes show usually only on short ranges and from strong targets. They can be reduced through careful reduction of the gain or proper adjustment of the A/C SEA control.

Virtual image

A relatively large target close to your ship may be represented at two positions on the screen. One of them is the true echo directly reflected by the target and the other is a false echo which is caused by the mirror effect of a large object on or close to your ship as shown in the figure below. If your ship comes close to a large metal bridge, for example, such a false echo may temporarily be seen on the screen.

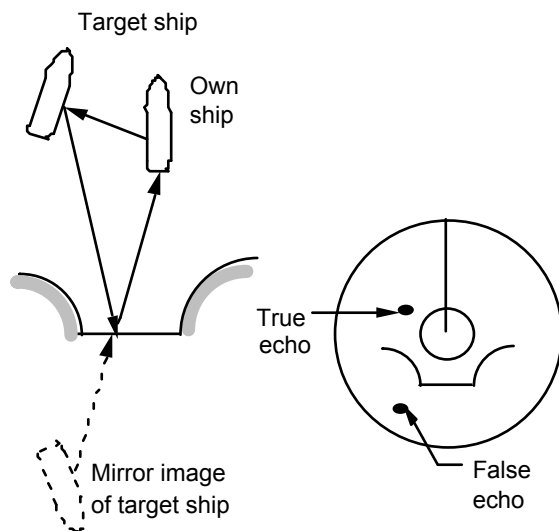

Virtual image by mirror effect

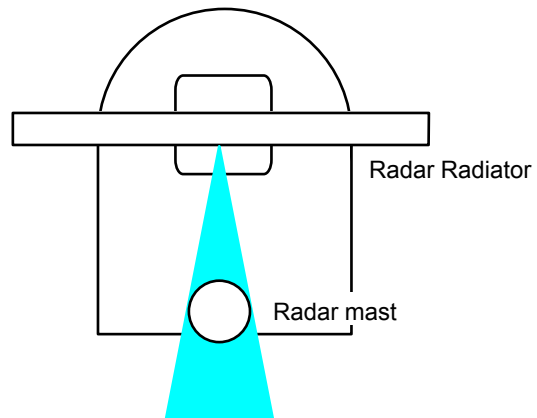

Shadow sector by stern block

Shadow sectors (see above right)

Funnels, stacks, masts, or derricks in the path of the scanner block the radar beam. If the angle subtended at the scanner is more than a few degrees, a non-detecting sector may be produced. Within this sector targets can not be detected.

3.3 SART (Search and Rescue Transponder)

A Search and Rescue Transponder (SART) is generally carried on the SOLAS Convention ships under the GMDSS scheme. It serves as a homing device for the rescue party to reach the survival craft in distress. It is triggered by any X-Band (3 cm) radar within a range of approximately 5 nm (IMO Resolution A.802 (19)). Each radar pulse received causes it to transmit a response which is swept repetitively across the complete radar frequency band. When interrogated, it first sweeps rapidly ($0.4 \mu\text{s}$) through the band before beginning a relatively slow sweep ($7.5 \mu\text{s}$) through the band back to the starting frequency. This process is repeated for a total of twelve complete cycles. At some point in each sweep, the SART frequency will match that of the interrogating radar and be within the pass band of the radar receiver. When the SART is within about 1 nm, the radar display may show 12 responses equally spaced by 0.64 nautical miles.

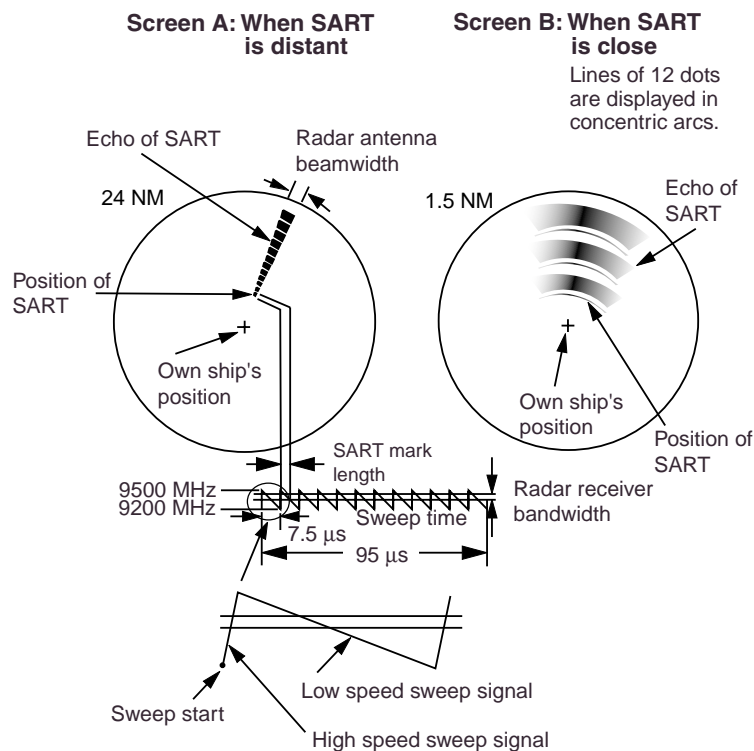

Summary to detect SART response

No particular facilities are required to detect the SART responses; however, the following precautions are necessary.

1. Use range scale of 6 or 12 nm as the spacing between the SART responses is about 0.6 nm (1125 m) to distinguish the SART.
2. To avoid a chance of regarding SART signals as noise, do the following:
 - Turn off the automatic clutter suppression.
 - Turn off the Interference Rejector.
 - Turn off the signal processor such as Echo Average.

The FR-1500 Mark-3 series radars have a macro feature for easy detection of SART.

Press **[F1]**, **[0]**, **[ENTER/SELECT]**. The following setting is factory provided.

IR (Interference Rejector):	OFF	ECHO AVG:	OFF
A/C AUTO:	OFF	N REJ:	OFF
Signal processor:	OFF	ES:	OFF
Range:	12 nm		

General remarks on receiving SART

Radar range scale

When looking for a SART it is preferable to use either the 6 or 12 nautical mile range scale. This is because the total displayed length of the SART response of 12 (or 24) dots may extend approximately 9.5 nautical miles beyond the position of the SART and it is necessary to see a number of response dots to distinguish the SART from other responses.

SART range errors

When responses from only the 12 low frequency sweeps are visible (when the SART is at a range greater than about 1 nm), the position at which the first dot is displayed may be as much as 0.64 nm beyond the true position of the SART. When the range closes so that the fast sweep responses are seen also, the first of these will be no more than 150 meters beyond the true position.

Radar bandwidth

This is normally matched to the radar pulselength and is usually switched with the range scale and the associated pulselength. Narrow bandwidths of 3-5 MHz are used with long pulses on long range scales and wide bandwidths of 10-25 MHz with short pulses on short ranges.

A radar bandwidth of less than 5 MHz will attenuate the SART signal slightly, so it is preferable to use a medium bandwidth to ensure optimum detection of the SART.

Radar side lobes

As the SART is approached, side lobes from the radar antenna may show the SART responses as a series of arcs or concentric rings. These can be removed by the use of the anti-clutter sea control although it may be operationally useful to observe the side lobes as they may be easier to detect in clutter conditions and also they will confirm that the SART is near to own ship.

Detuning the radar

To increase the visibility of the SART in clutter conditions, the radar may be detuned to reduce the clutter without reducing the SART response. Radar with automatic frequency control may not permit manual detune of the equipment. Care should be taken in operating the radar in the detuned condition as other wanted navigational and anti-collision information may be removed. The tuning should be returned to normal operation as soon as possible.

Gain

For maximum range SART detection the normal gain setting for long range detection should be used, i.e., with a light background noise speckle visible.

A/C SEA control

For optimum range SART detection, this control should be set to the minimum. Care should be exercised as wanted targets in sea clutter may be obscured. Note also that in clutter conditions the first few dots of the SART response may not be detectable, irrespective of the setting of the anti-clutter sea control. In this case, the position of the SART may be estimated by measuring 9.5 nautical miles from the furthest dot back towards own ship.

Some sets have automatic/manual anti-clutter sea control facilities in which case the operator is advised to use manual control initially until the SART has been detected. The effect of the auto sea control on the SART response can then be compared with manual control.

A/C RAIN control

This should be used normally (i.e. to break up areas of rain) when trying to detect a SART response which, being a series of dots, is not affected by the action of the anti-clutter rain circuitry. Note that RACON responses, which are often in the form of a long flash, will be affected by the use of this control.

Some sets have automatic/manual anti-clutter rain control facilities in which case the operator is advised to use manual control initially until the SART has been detected. The effect of the auto sea control on the SART response can then be compared with manual control.

This information is excerpted from IMO SN/Circ 197 OPERATION OF MARINE RADAR FOR SART DETECTION.

3.4 RACON (Radar Beacon)

A RACON is a radar beacon which emits pulses in the radar frequency spectrum (X or S band). There are several signal formats; in general, the RACON signal appears on the radar screen as a rectangular echo originating at a point just beyond the position of the radar beacon. It has a Morse coded pattern. Sometimes, the echo may appear solid, sometimes separated, depending on the code and radar range scale in use.

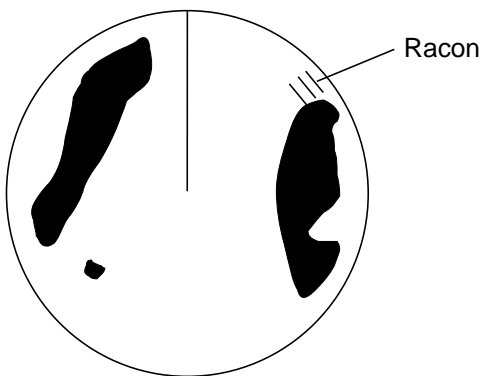

4 OPERATION OF VIDEO PLOTTER RP-17 (OPTION)

(Needed for Radar Mapping)

The Video Plotter RP-17 is an optional circuit board which is accommodated in the display unit of the FR-1500 MARK-3 series radars. It permits use of two memory cards: a memory card(RAM) for storing the operator-created radar maps, and the other is a chart card(ROM) storing FURUNO made digital charts.

The memory card enables the operator to create radar maps more precisely than the standard supplied radar map card. The radar map can hold a maximum of 6,000 points. The card permanently retains the data you have entered from the radar display or by Lat/Long positions. Own ship and other ship tracks may be stored at a selected interval.

Charts are superimposed on the radar picture without disturbing the radar observation. The chart area is dependent on the radar range in use.

The drive for the ROM card can also drive the Electronic Reference Chart (ERC). The ERC is a digital chart published by the Japanese Hydrographic Bureau. Note it is not an ENC used for ECDIS.

For details, refer to the separate manual for the Video Plotter RP-17.

Note: The RP-17 may be used with the IMO specification radar, however the video plotter display is not available.

This page is intentionally left blank.

5 MAINTENANCE



WARNING

Do not open the equipment

Hazardous voltage which can cause electrical shock exists inside the equipment. Only qualified personnel should work inside the equipment.

Turn off the radar power switch before servicing the antenna unit. Post a warning sign near the switch indicating it should not be turned on while the antenna unit is being serviced.

Prevent the potential risk of being struck by the rotating antenna and exposure to RF radiation hazard.

Wear a safety belt and hard hat when working on the antenna unit.

Severe injury or death can result if someone falls from the radar antenna mast.

Notice for technicians

The display unit designed to run on AC voltage has a switch (S2) at its rear to cut off 115/230 V supply from internal circuits. Turn off the switch when accessing inside the display unit.

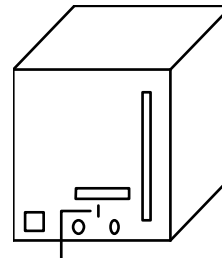

Switch S2

5.1 Periodic Maintenance Schedule

Periodic checks and maintenance are important for proper operation of any electronic systems. This chapter contains maintenance instructions to be followed to obtain optimum performance and the longest possible life of the equipment.

Interval	Check point	Check and measures	Remarks
3 to 6 months	Exposed nuts and bolts on antenna unit	Check for corroded or loosened nuts and bolts. If necessary, clean and repaint them thickly. Replace them if heavily corroded.	Sealing compound may be used instead of paint. Apply a small amount of grease between nuts and bolts for easy removal in future.
	Antenna radiator	Check for dirt and cracks on radiator surface. Thick dirt should be wiped off with a soft cloth dampened with fresh water. If a crack is found, apply a slight amount of sealing compound or adhesive as a temporary remedy, then call for repair.	Do not use plastic solvent (acetone) for cleaning. If you need to remove ice from antenna unit, use a wooden hammer or plastic head hammer. Crack on the unit may cause water ingress, causing serious damages to internal circuits.

	Terminal strips and plugs in antenna unit	Open antenna cover to check terminal strip and plug connections inside. Also check the rubber gasket of antenna covers for deterioration.	When closing antenna covers in position, be careful not to catch loose wires between covers and unit.
6 months to one year	CRT and surrounding components	High voltage at CRT and surrounding components attract dust in environment which will cause poor insulation. Ask your nearest FURUNO representative or dealer to clean internal high-voltage components.	If CRT anode rubber cap or wire sheath is cracked, ask your dealer to replace it. Wait for at least 3 minutes until high voltage components (CRT and HV capacitors) discharge their residual charges before accessing them.
	Terminal strips, sockets, earth terminal	Check for loose connections. Check contacts and plugs for proper seating, etc.	

5.2 Life Expectancy of Major Parts

Parts	Type	Life expectancy	Remarks
Antenna motor	D8G-571 (X-band) 42 rpm D8G-571 (X-band) 24 rpm	Gears more than 10,000 h	Wind load 100 kt
Magnetron	MG5389, X-band, 6 kW MAF1422B, X-band, 6 kW MG4006, X-band, 6 kW MAF1425B, X-band, 12 kW MG4010, X-band, 12 kW MG5436, X-band, 25 kW	2,000 - 3,000 h	

5.3 Replacement of Batteries

The GYRO CONVERTER Board (option) and the RP Board have a battery. The battery for the RP Board preserves data when the power is turned off, and its life is about five years. When the battery voltage of the battery on the RD Board is low, NG (No Good) appears at the diagnostic test for the RP board. When this happens, contact your dealer to request replacement of the battery.

6 TROUBLESHOOTING

6.1 Easy Troubleshooting

This paragraph describes how to cure operational problems, which can be made by observing the radar picture and using operator controls and keys without opening the display unit, antenna unit or other equipment units.

Problem	Remedy
Power turned on but radar does not operate at all. Control panel is not illuminated.	Check fuse. If it is blown, replace it.
Marks, legends and noise appear but no echo.	Check Tx fuse. If it is blown, replace it.
Picture not updated or picture freeze up.	<ul style="list-style-type: none">• Check connection of signal cables.• For video freeze up turn off and on the radar.
TUNE control adjusted but poor sensitivity.	<ul style="list-style-type: none">• Clean the radiator surface.• Remove water from the feeder line.• Second trace rejection is on. Turn it off. (See paragraph 1.31.)
Range changed but radar picture does not change.	<ul style="list-style-type: none">• Try to hit the [+] and [-] keys several times.• Turn off and on the radar.
Only 2 parallel index lines when 6 lines are wanted.	Set index line interval correctly on the OTHER menu.
Poor discrimination in range.	Adjust A/C SEA control.
True motion presentation not working properly.	Try to press MODE key a little harder.
Target not tracked correctly.	Adjust A/C SEA and A/C RAIN controls.
Range rings are not displayed.	Adjust brilliance of range rings on BRILL menu.
No own ship marker	On R-type check setting of OS MRK on OTHER menu.

6.2 Advanced-level Troubleshooting

This paragraph describes how to cure hardware and software troubles which should be carried out by qualified service personnel.

Note: This radar equipment contains complex modules in which fault diagnosis and repair down to component level are not practicable by users.

Serviceman qualification

All adjustments of radio transmitter during or coinciding with the installation, servicing, or maintenance which may affect the proper operation must be performed by or under the immediate supervision and responsibility of a person holding an operator certificate containing a ship radar endorsement.

This is what the U.S. Codes of Federal Regulations part 80.169 implies (not exact extract).

As such, every administration sets forth its own rule; service personnel must be aware of this kind of competency requirements.

Service call

When making a service call to your service agent, check S/N and symptom beforehand.

Problem	Probable causes or check points	Remedy
Power turned on but radar does not operate at all. Control panel is not illuminated.	1 Blown fuse F1 and F2. 2 Mains voltage/polarity 3 Power supply board 4 Illumination lamps	1 Replace blown fuse. 2 Correct wiring and input voltage. 3 Replace power supply board. 4 Replace defective lamps.
CRT brilliance adjusted but no picture.	1 CRT high tension voltage 2 SPU board	1 Check high tension voltage supply with utmost care. DANGER. 2 Replace SPU board.

(Continued on next page)

Problem	Probable causes or check points	Remedy
Antenna not rotating	<ol style="list-style-type: none"> 1 Antenna drive mechanism (note that the message BRG SIG MISSING appears in standby). 2 Defective antenna drive motor relay (thermal relay K2, 200/220/380, 440/100 VAC) 	<ol style="list-style-type: none"> 1 Make sure that there is no short circuit across #1 and #2 of J482 on HV 9017 board. 2 Press relay reset button.
Data and marks not displayed in Transmit status	<ol style="list-style-type: none"> 1 SPU board 	<ol style="list-style-type: none"> 1 Replace SPU board.
Adjust GAIN control with A/C SEA control set at minimum. Marks and legends appear but no noise or echo.	<ol style="list-style-type: none"> 1 IF amplifier 2 Signal cable between antenna and display 3 Video amplifier board 	<ol style="list-style-type: none"> 1 Replace IF amplifier. 2 Check continuously and isolation of coaxial cable. Note: Disconnect the plug and lugs at both ends of coaxial cable before checking it by ohmmeter. 3 Check video coax line for secure connection. If connection is good, replace SPU board.
Marks, legends and noise appear but no echo: (Transmission leak representing own ship position is absent.)	<ol style="list-style-type: none"> 1 TX fuse F801 (Transmitter unit) 2 Magnetron 3 Modulator board 4 SPU board 	<ol style="list-style-type: none"> 1 If fuse is blown, replace it. If it blows again, the modulator or associated circuit may be defective. 2 Check magnetron current with the check meter in the sub panel. Replace magnetron. 3 Replace modulator board. 4 Replace SPU board.
Picture not updated or picture freeze-up.	<ol style="list-style-type: none"> 1 Bearing signal generator board (in antenna unit) 2 SPU board 3 Video freeze-up 	<ol style="list-style-type: none"> 1 Check the connection of signal cables. 2 Replace SPU board. 3 Turn off and on the radar.
Incorrect orientation of picture	<ol style="list-style-type: none"> 1 SPU board 2 Gyro interface 	<ol style="list-style-type: none"> 1 HD SIG MISSING appears when the heading pulse is not received during standby. 2 Replace the gyro interface.

(Continued on next page)

Problem	Probable causes or check points	Remedy
TUNE control adjusted but poor sensitivity.	<p>1 Deteriorated magnetron</p> <p>1 Detuned MIC</p> <p>3 Dirt on radiator face</p> <p>4 Water ingress to the waveguide or other feeder line</p> <p>5 Second trace rejection is ON</p>	<p>1 With radar transmitting on 48 nm range, check magnetron current. If current is below normal, magnetron may be defective. Replace it.</p> <p>2 Check MIC detecting current. If it is below normal value, MIC may have become detuned. MIC must be tuned.</p> <p>3 Clean the radiator surface.</p> <p>4 Remove water from the feeder line.</p> <p>5 Disable the second-trace rejector referring to section 1.31.</p>
Range changed but radar picture not changing.	<p>1 Defective range key</p> <p>2 SPU board</p> <p>3 Mother board</p> <p>4 Video freeze-up</p>	<p>1 Try to hit [+] and [-] range keys several times. If unsuccessful, replacement of keypad may be required.</p> <p>2 Replace SPU board.</p> <p>3 Replace mother board.</p> <p>4 Turn off and on radar.</p>
Interference rejector inoperable (interference rejection level not displayed)	<p>1 Bad contact of key</p> <p>2 SPU board</p> <p>3 Mother board</p>	<p>1 Repair contact of key.</p> <p>2 Replace SPU board.</p> <p>3 Replace mother board.</p>
Echo stretch ineffective (Neither ES1 nor ES2 is displayed)	<p>1 SPU board</p>	<p>1 Replace SPU board.</p>
Only 2 parallel index lines when 6 lines are wanted.	<p>1 Incorrect setting of index line intervals</p>	<p>1 Set index line interval adequately</p>
Range rings are not displayed.	<p>1 Adjust the brilliance of range rings at the BRILL menu to see if intensity is increased.</p> <p>2 SPU board</p>	<p>1 Replace associated circuit board if unsuccessful.</p> <p>2 Replace SPU board.</p>

(Continued on next page)

Problem	Probable causes or check points	Remedy
Poor discrimination in range	1 Sea clutter control not functioning properly	1 Improper setting of A/C SEA control. If A/C SEA is seen only at very close range, suspect inaccurate frequency of reference oscillator.
True motion presentation not working correctly	1 Poor contact of MODE key 2 Selection not accessed 3 Speed entry incorrect 4 TM display inaccurate	1 Try to press MODE key a little harder. 2 Press MODE key until TM appears. 3 Enter correct own ship speed adequately 4 Make sure that speed and compass inputs are accurate.
Target not tracked correctly	1 Poor definition of targets in sea clutter	1 Adjust A/C SEA and A/C RAIN controls adequately.

6.3 Diagnostic Test

A diagnostic test program is provided to enable testing of major circuit boards in the radar display unit. Note that the normal radar picture is lost during this test.

Proceed as follows to execute the diagnostic test:

1. Press [MENU] [0] [0] to show the OTHERS main.
2. Press the [0] key twice to select the OTHERS sub menu.
3. Press the [2] key twice to select TEST.

The diagnostic test is executed and the screen shows test results as shown on the next page. OKs appear for normal operation. ARP TEST results appear only when optional ARP Board is mounted. If NG (No Good) appears, corresponding components may be defective. Consult your dealer.

4. Small squares displayed on the test results screen are for testing the controls and keys (except POWER and [ENTER/SELECT] keys). As you operate these controls and keys, corresponding squares are highlighted, indicating that your control/key operations are properly recognized.
5. Press the [ENTER/SELECT] key to check the display circuit. See the illustration page 6-7.
6. To terminate the diagnostic test, press the [MENU] key.

Sequence for diagnostic test

[MENU] KEY

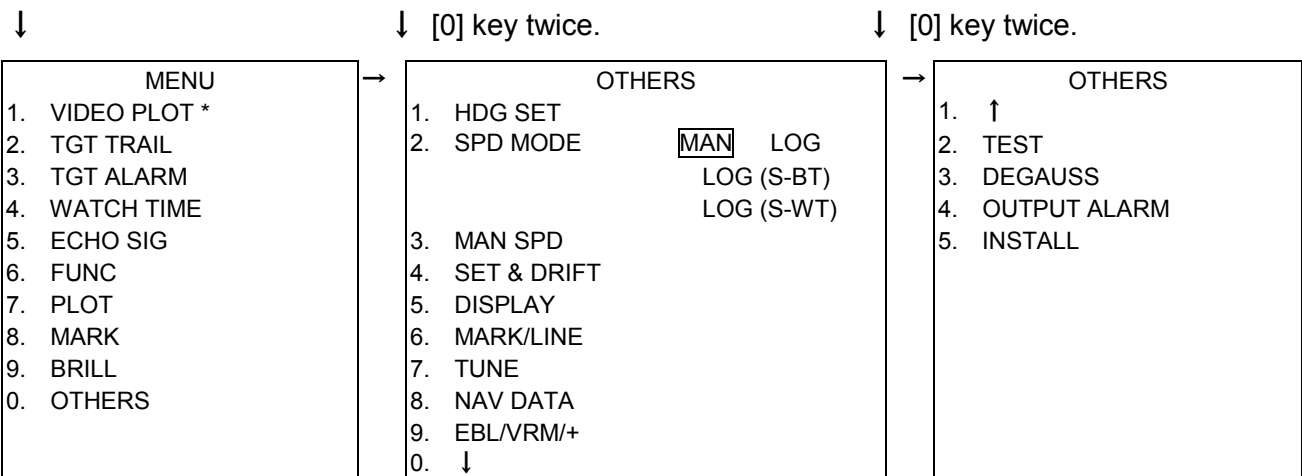

Press the [2] key twice to start test. The following appears.

FR-1500 M-3 SERIES TEST

1. Program No.	0359152107		
2. ROM Check	OK	EPA	OK
3. RAM Check	OK		
4. Antenna Rotation	rpm		
5. TX Trigger Frequency	3000Hz		
6. Video Level	000		
7. Video Signal	OK		

Press MENU key to escape
Press ENTER key to check CRT.

(Color Pallet
From left: Red, Green,
Yellow, Blue, Pink, Light
Blue, White)

ARP TEST

1. Program No.	1859041102	1859042101
2. ROM Check	OK	OK
3. RAM Check	OK	
4. Speed Log	OK 0.0KT	
5. Course	OK	
6. Trigger	OK	
7. Video Signal	OK	
8. Bearing Pulse	OK	
9. Heading Pulse	OK	
10. Minimum Hit	0003	
11. Scan Time	0804	
12. Manual Acq.	00	
13. Auto Acq.	00	
14. FE-Data 1	0000	
15. FE-Data 2	0000	

Control check: Bar increases in length with clockwise rotation.

EBL control check

VRM control check

This test pattern appears when you punch [MENU], [0], [0], [2].

CRT ADJ

1. CRT ADJ
2. H SIZE
3. H POSITION
4. V SIZE
5. V POSITION
6. PIN CUSHION
7. BRIGHTNESS

This test pattern appears when you punch [MENU], [0], [0], [2], [ENTER/SELECT].

6.4 Menu Hierarchy

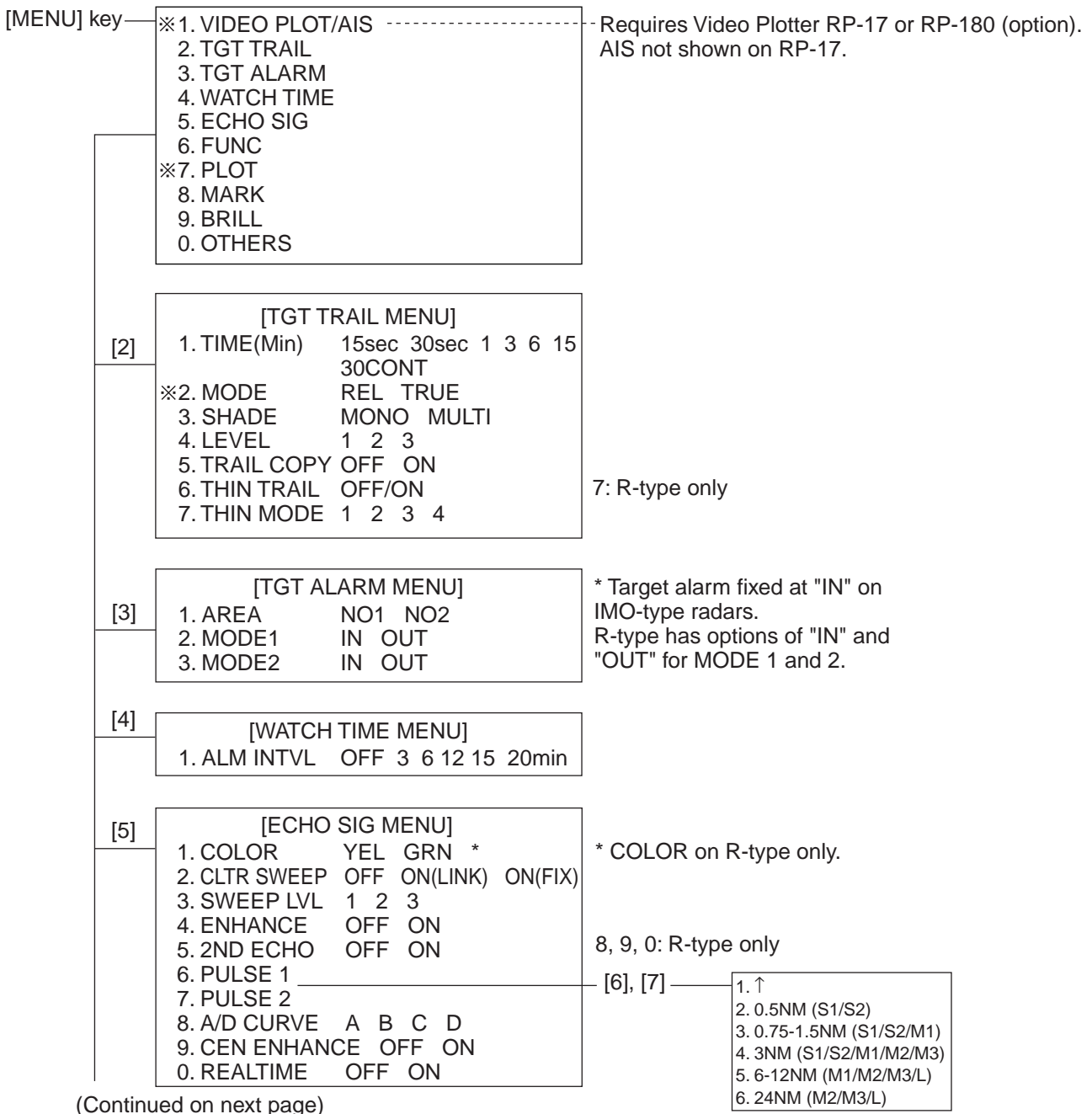

※ : When the heading sensor is not connected, these functions are inoperative.

[MENU] key +

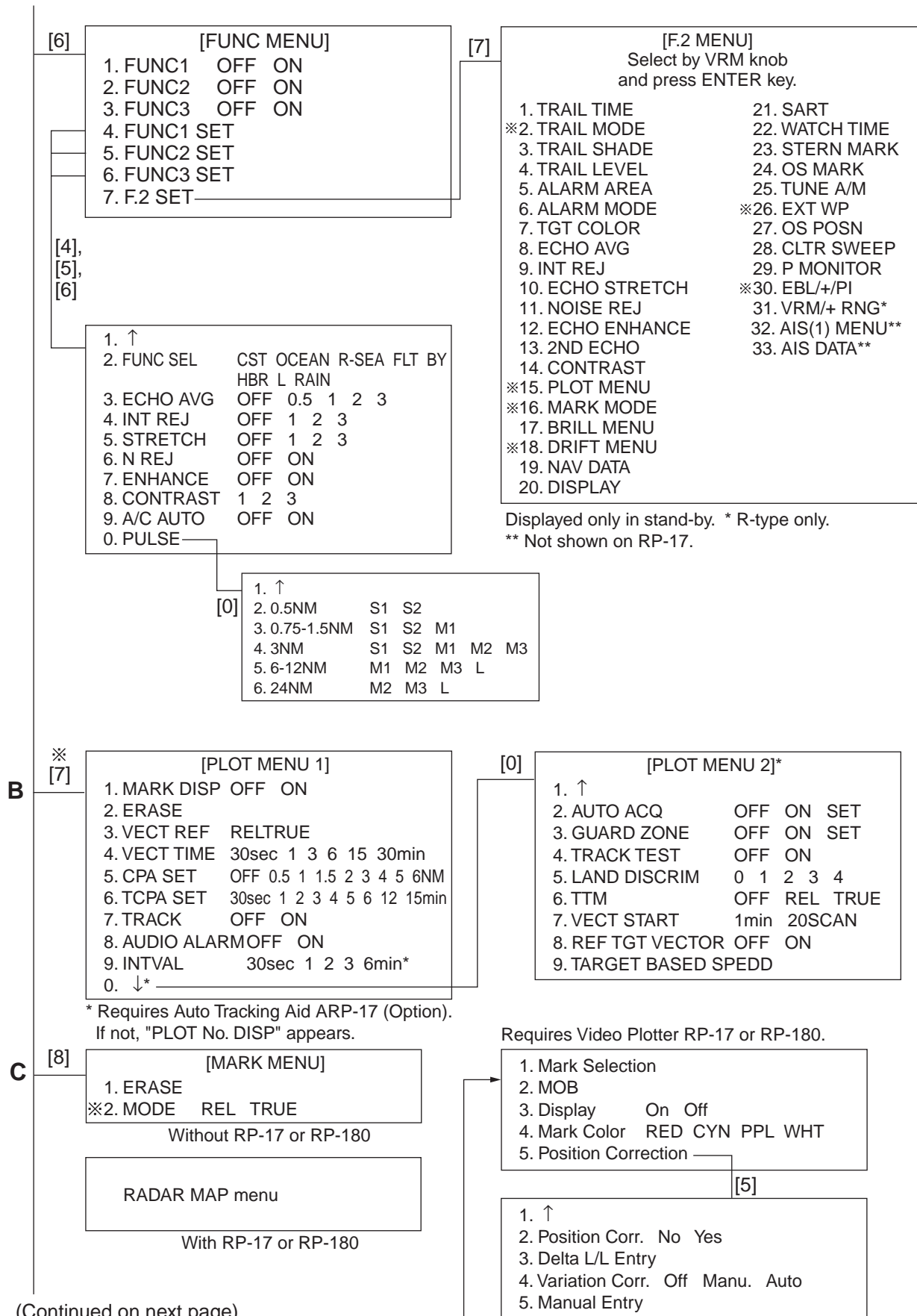

(Continued on next page)

[MENU] key +

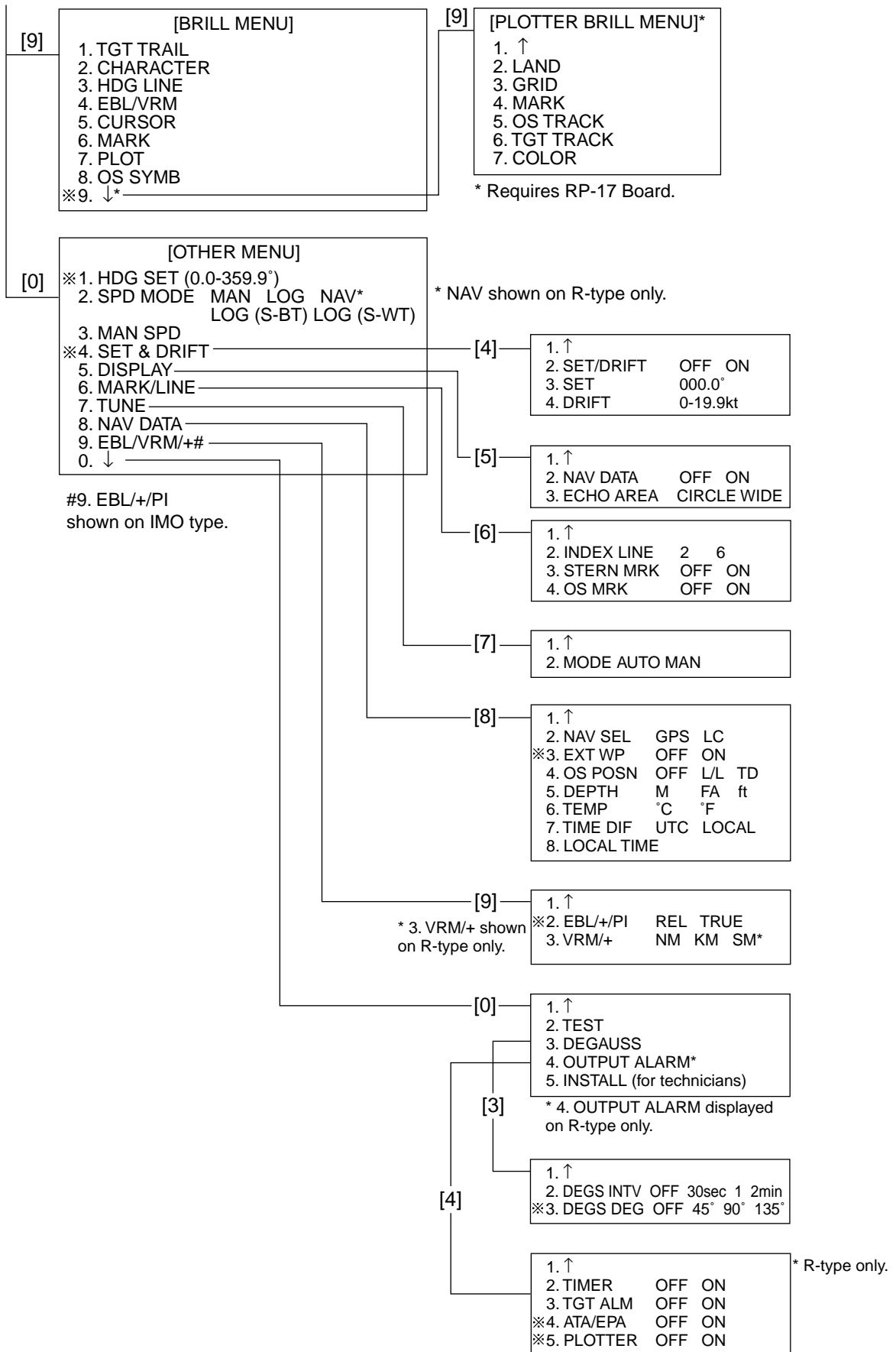

7 OPTIONAL EQUIPMENT

7.1 Performance Monitor (Option)

A performance monitor is required for a radar installed on certain type of ship as determined by the Administrations. The FURUNO PM-30 (for X-band radars) covers 9410 ± 50 MHz.

It works on the transponder principle. It sends response back to the radar antenna upon receiving the pulse from the radar antenna and determines if transmitter or receiver or both are deteriorated in comparison with the state of the precious calibration.

Operating the performance monitor

1. When Radar Interswitch is connected (depending on the type), set it to the "straight" mode.
2. Press [F1], [9] keys in this order. Monitoring arcs do not harm the radar performance but if they disturb to radar observation, turn it off by pressing [F1] [9]. ([F1] [9] toggles Performance Monitor ON and OFF.)
3. When the Performance Monitor is on by [F1], [9] the following condition results:
PM power: ON, IR: OFF, ECHO AVG: OFF, ES: OFF, A/C AUTO: OFF, N REJ: OFF, RANGE: 24 nm

Wait for 10 minutes and the radar screen will show several arcs, opposite to the heading marker (provided that the performance monitor is installed behind the radar antenna as is normally the case). If the radar transmitter and receiver are in good working conditions in as much as the original state when the monitor was tuned up, the innermost arc should appear at 12 nm and there should be a total of 4 arcs.

The range of the innermost arc reduces 3 nm with every 3 dB loss of transmitted power. Receiver sensitivity can be evaluated from the number of visible arcs; one arc is lost every 3 dB deterioration of the sensitivity.

Transmitter performance		Receiver performance	
Range to innermost arc	Loss	Number of arcs	Loss
12 nm	0 dB	4	0 dB
9 nm	3 dB	3	3 dB
6 nm	6 dB	2	6 dB
3 nm or less or none	> 10 dB	1	> 9 dB
		0	> 12 dB

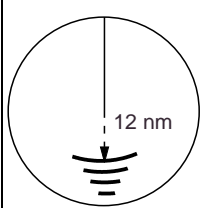

4 arcs starting at 12 nm

Transmitter: normal

Receiver: normal

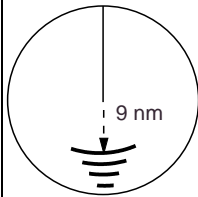

Transmitter: 3 dB loss
(Transmitter system has lost a half of initial power. Suspect magnetron.)

Receiver: normal

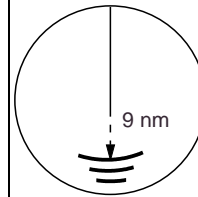

Transmitter: 3 dB loss
(Transmitter system has lost a half of initial power. Suspect magnetron.)

Receiver: 3 dB loss (Receiver has lost a half of initial sensitivity. Suspect receiver front end, water ingress in feeder system, etc.)

8 DIGITAL INTERFACE (IEC 61162-1 Edition 1 and 2)

1 I/O Sentences for Channel 1

Input

BWC, BWR, DBK *, DBS *, DBT, DPT, GDD *, GGA, GLL, GTD *, HDG, HDM *, MDA *, MTW (*),
RMA, RMB, RMC, VBW, VHB, VTG(*), ZDA

(*) not recommended in IMO type, * R-Type Only

Output

RSD (every 4 s), TLL * (When A/C RAIN control is pressed.) * R-Type Only

2 I/O Sentences of Channel 2

Channels 2 sentences have priority over channel 1 signals.

Input

DBK *, DBS *, DPT, MDA *, MTW, VBW * R-type only

Output

TTM (Interval: 1-7 tgts, 2.5 sec.; 8-15 tgts, 5.0 sec., 16-20 tgts, 10.0 sec.)

3 I/O Sentences of Channel 3

Heading data, I/O sentences of channels 3 have priority over channel 1 signals when both are input.

Input

HDB *, HDG, HDM, HDT, VHW * R-type only

Output

None

4 Sentence Description

See pages which follow.

5 Priority

Nav data sentences below are read left to right, and in case of timeout the sentence right of last read sentence is read. In case of multiple high priority sentences the sentences having the highest priority is read. ** is read regardless of talker. Timeout is 90 seconds unless specified otherwise.

Position data

GPS: GPGGA > GPRMC > GPGLL
LC: LCRMA > LCGLL
Timeout: 30 seconds
Time difference (TD)
LCRMA > LCGLC > LCGTD * (* R-type only)

Date, time data

GPZDA
Timeout: 10 seconds

Course heading, speed over ground

In the case of log

**VBW

In the case of EPFS

GPS: GPVTG > GPRMC
LC: LCVTG > LCRMA

Speed through water

**VBW

Water depth data

**DPT > **DBT (IMO-type)
**DPT > **DBK > **DBS > **DBT (R-type)

Water temperature data

**MTW (IMO type)
**MDA > **MTW (R-type)

Waypoint range and bearing data

Without RP-17
GPS: GPBWR > GPBWC > GPRMB
LC: LCBWR > LCBWC > LCRMB
With RP-17
Waypoint L/L data
GPS: GPBWR > GPBWC > GPRMB
LC: LCBWR > LCBWC > LCRMB

Ship's heading

T: **HDT > **HDG > **HDM ± VAL > **VHW
R: **HDM > **HDG > **HDT ± VAL > **VHW
NOTE: ATA uses only AD-10 format gyrocompass data.

Description of Sentences

Note: Checksum for RMA, RMB and RMC is mandatory. Checksum for other sentences is evaluated if it exists. If there is no checksum, data is treated as valid data.

BWC - Bearing and distance to waypoint

BWR - Bearing and distance to waypoint - rhumb line

Time (UTC) and distance and bearing to, and location of, a specified waypoint from present position. \$--BWR data is calculated along the rhumb line from present position rather than along the great circle path.

\$--BWC, hhmmss.ss, llll.ll, a yyyyy.yy, a, x.x, T, x.x, M, x.x, N, c--c, a*hh<CR><LF>

\$--BWR, hhmmss.ss, llll.ll, a yyyyy.yy, a, x.x, T, x.x, M, x.x, N, c--c, a*hh<CR><LF>

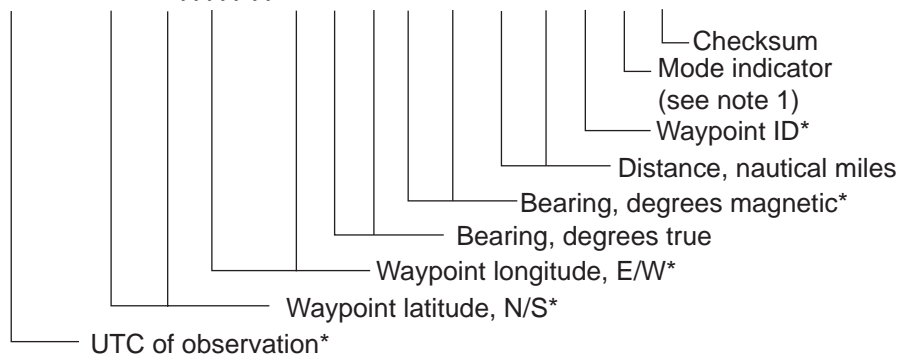

*: Not used

NOTE 1: Positioning system Mode indicator:

A= Autonomous mode

D= Differential mode

E= Estimated (dead reckoning) mode

M= Manual input mode

S= Simulator mode

N= Data not valid

The Mode indicator field shall not be a null field.

DBS - Depth below sea surface

\$--DBS,x,x,f,x,x,M,x,x,F*hh<CR><LF>

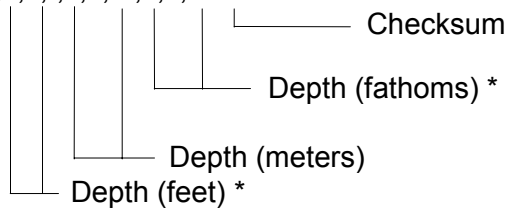

* Not used

DBK - Depth below keel

DBT - Depth below transducer

Water depth referenced to the transducer.

\$--DBT, x.x, f, x.x, M, x.x, F*hh<CR><LF>

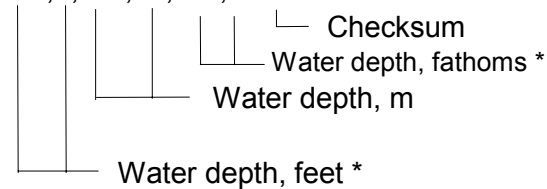

* Not used

DPT - Depth

IMO Resolution A.224 (VII). Water depth relative to the transducer and offset of the measuring transducer. Positive offset numbers provide the distance from the transducer to the waterline. Negative offset numbers provide the distance from the transducer to the part of the keel of interest.

\$--DPT, x.x, x.x*hh<CR><LF>

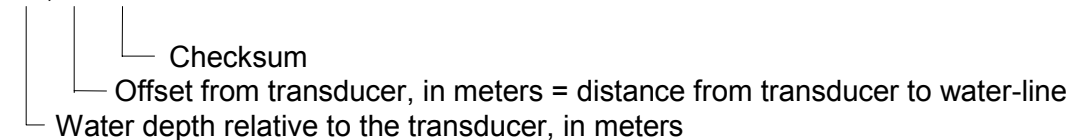

* Not used

GGA - Global positioning system (GPS) fix data

Time, position and fix related data for a GPS receiver.

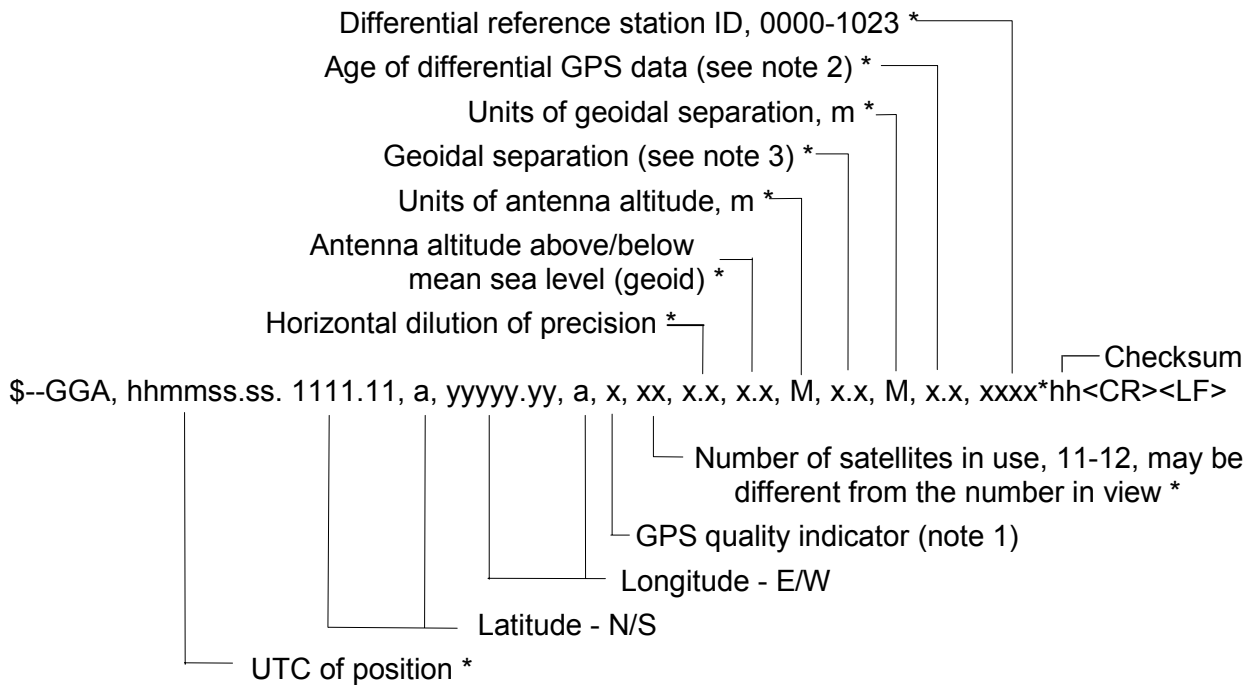

* Not used

NOTES

- 1 GPS quality indicator:
- | | |
|--|-------------------------------------|
| 0 = fix not available or invalid | 6 = Estimated (dead reckoning) mode |
| 1 = GPS SPS mode, fix valid | 7 = Manual input mode |
| 2 = differential GPS, SPS mode, fix valid | 8 = Simulator mode |
| 3 = GPS PPS mode GPS fix valid | |
| 4 = Real Time Kinematic. Satellite system used in RTK mode with fixed integers | |
| 5 = Float RTK. Satellite system used in RTK mode with fixed floating integers | |

2 Time in seconds since last SC104 type 1 or 9 update, null field when DGPS is not used.

3 Geoidal separation: the difference between the WGS-84 earth ellipsoid and mean sea level (geoid), "-" = mean sea level below ellipsoid.

GLL - Geographic position - latitude/longitude

\$-GLL, llll.ll, a yyyy.yy, a, hhmmss.ss, A, a *hh<CR><LF>

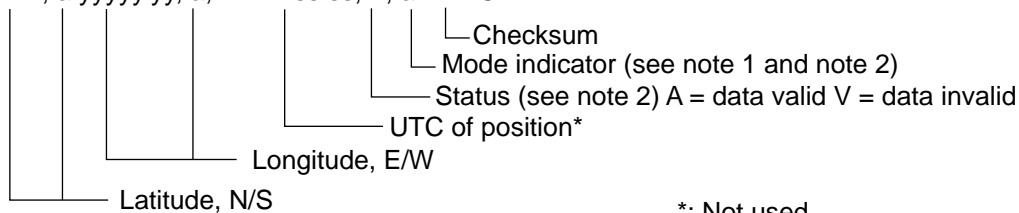

*: Not used

NOTE 1: Positioning system Mode indicator:

A= Autonomous mode

D= Differential mode

E= Estimated (dead reckoning) mode

M= Manual input mode

S= Simulator mode

N= Data not valid

NOTE 2: The Mode Indicator field supplements the Status field (field 6). The Status field shall be set to V = invalid for all values of Operating Mode except or A = Autonomous and D = Differential. The positioning system Mode indicator and Status fields shall not be null fields.

HDG - Heading, deviation and variation

IMO Resolution A.382 (X). Heading (magnetic sensor reading), which if corrected for deviation, will produce magnetic heading, which if offset by variation will provide true heading.

\$--HDG, x.x, x.x, a, x.x, a*hh<CR><LF>

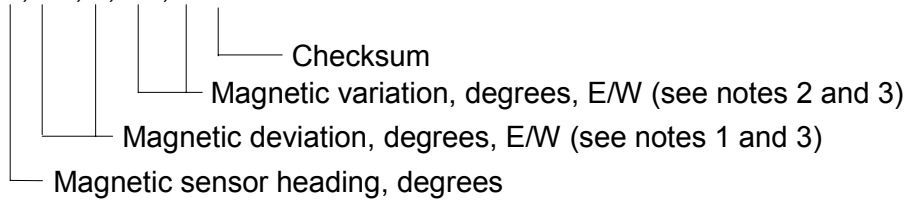

* Not used

- NOTES
- To obtain magnetic heading: Add easterly deviation (E) to magnetic sensor reading
Subtract westerly deviation (W) from magnetic sensor reading
 - To obtain true heading: Add easterly variation (E) to magnetic heading
Subtract westerly variation (W) from magnetic heading
 - Variation and deviation fields will be null fields if unknown.

HDT - Heading True

\$--HDT, x.x, T*hh<CR><LF>

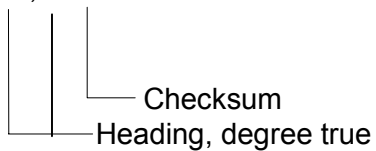

* Not used

MTW - Water temperature

\$--MTW, x.x, C*hh<CR><LF>

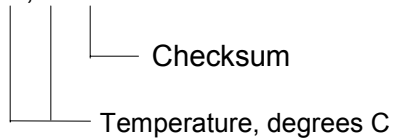

* Not used

RMA - Recommended minimum specific LORAN-C data

Position, course and speed data provided by a LORAN-C receiver. Time differences A and B are those used in computing latitude/longitude. Checksum is mandatory in this sentence. This sentence is transmitted at intervals not exceeding 2 s and is always accompanied by RMB when a destination waypoint is active. RMA and RMB are the recommended minimum data to be provided by a LORAN-C receiver. All data fields must be provided, null fields used only when data is temporarily unavailable.

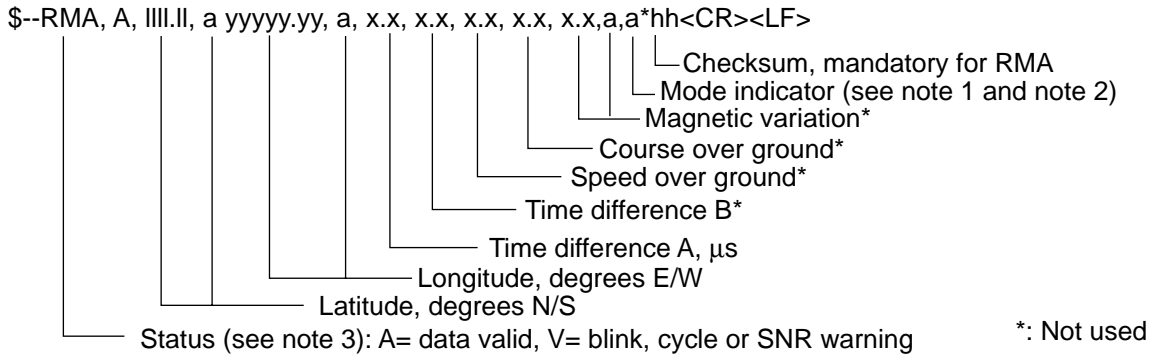

NOTE 1: Positioning system Mode indicator:

- A= Autonomous mode
- D= Differential mode
- E= Estimated (dead reckoning) mode
- M= Manual input mode
- S= Simulator mode
- N= Data not valid

NOTE 2: The positioning system Mode indicator field supplements the Status field (field No.1), which shall be set to V = invalid for all values of Mode indicator except for A = Autonomous and D = Differential. The positioning system Mode indicator and Status fields shall not be null field.

See paragraph 1.39 on page 1.37 for more information.

RMB - Recommended minimum navigation information

Navigation data from present position to a destination waypoint provided by a LORAN-C, TRANSIT, OMEGA, GPS, DECCA, navigation computer or other integrated navigation system. Checksum is mandatory in this sentence. This sentence always accompanies RMA or RMC sentences when a destination is active when provided by a LORAN-C, TRANSIT or GPS receiver, other systems may transmit \$--RMB without \$--RMA or \$--RMC.

\$--RMB, A, x.x, a, c--c, c--c, llll.ll, a yyyyy.yy, a,x.x, x.x, x.x,A,a*hh<CR><LF>

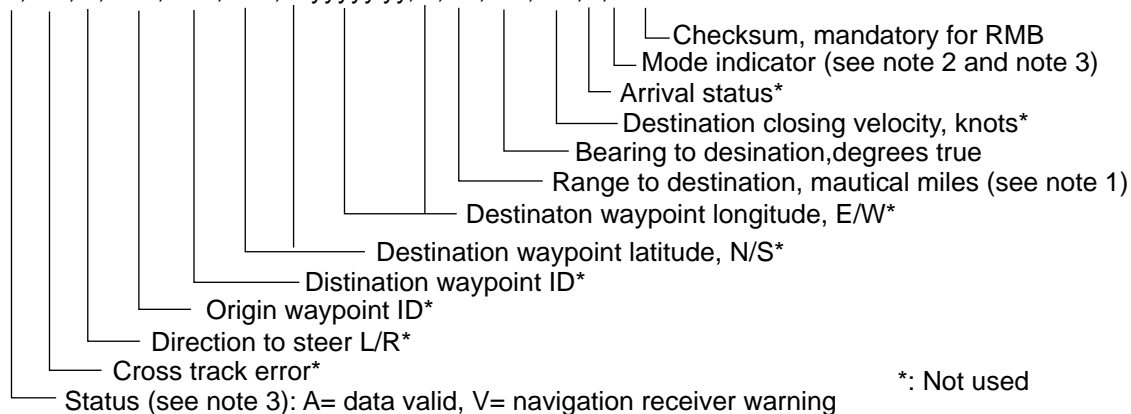

NOTE 1: If range to destination exceeds 999,9 nautical miles, display 999,9.

NOTE 2: Positioning system Mode indicator:

- A= Autonomous mode
- D= Differential mode
- E= Estimated (dead reckoning) mode
- M= Manual input mode
- S= Simulator mode
- N= Data not valid

NOTE 3: The positioning system Mode indicator field supplements the Status field (field No.1), which shall be set to V = invalid for all values of Mode indicator except for A = Autonomous and D = Differential. The positioning system Mode indicator and Status fields shall not be null field.

RMC - Recommended specific GPS/TRANSIT data

Time, date, position, course and speed data provided by a GPS or TRANSIT navigation receiver. Checksum is mandatory in this sentence. This sentence is transmitted at intervals not exceeding 2 s and is always accompanied by RMB when a destination waypoint is active. RMC and RMB are the recommended minimum data to be provided by a GPS or TRANSIT receiver. All data fields must be provided, null fields used only when data is temporarily unavailable.

\$--RMC, hhhmmss.ss, A, llll.ll, a yyyyy.yy, a, x.x, x.x, xxxxxx, x.x,a, a*hh<CR><LF>

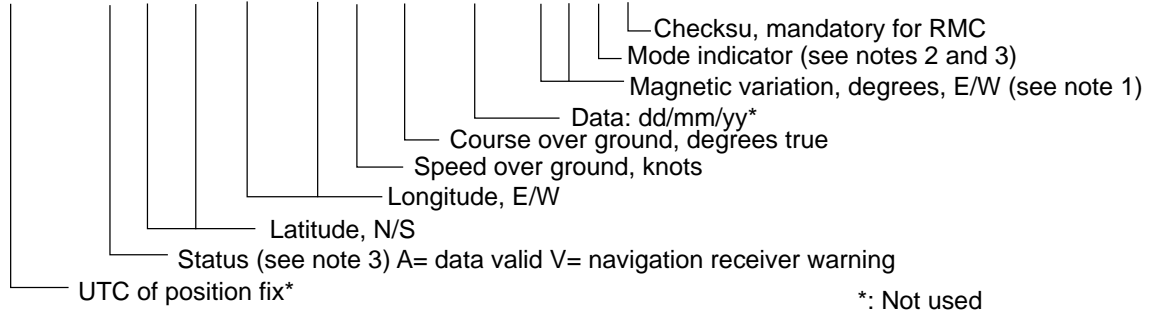

NOTE 1: Easterly variation (E) subtracts from true course. Westerly variation (W) adds to true course.

NOTE 2: Positioning system Mode indicator:

- A= Autonomous mode
- D= Differential mode
- E= Estimated (dead reckoning) mode
- M= Manual input mode
- S= Simulator mode
- N= Data not valid

NOTE 3: The positioning system Mode indicator field supplements the Status field (field No.2), which shall be set to V = invalid for all values of Mode indicator except for A = Autonomous and D = Differential. The positioning system Mode indicator and Status fields shall not be null fields.

RSD - Radar system data

IMO Resolution A.477 (XII). Radar display setting data.

\$--RSD, x.x, x.x, x.x, x.x, x.x, x.x, x.x, x.x, x.x, x.x, a, a*hh<CR><LF>

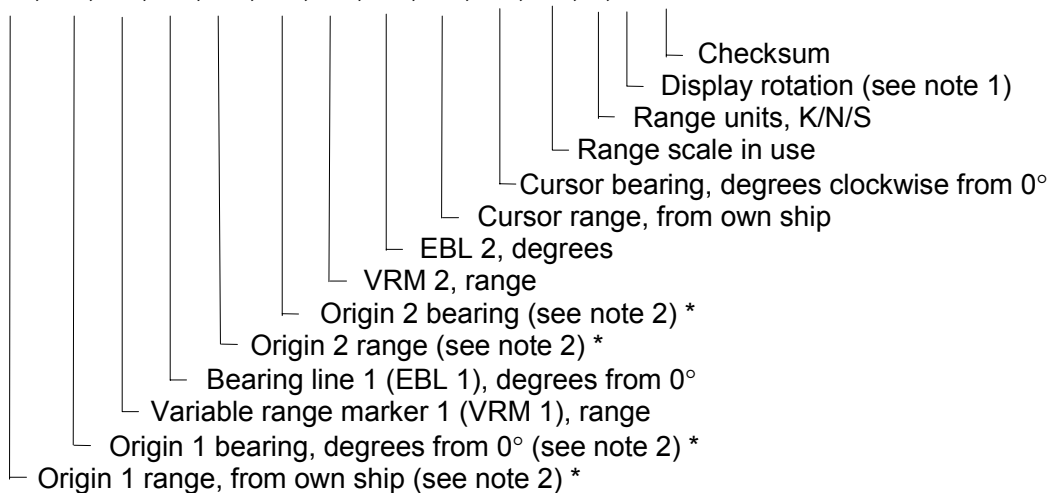

* Not used

NOTES 1 Display rotation: C = course-up, course-over-ground up, degrees true
 H = head-up, ship \pm s heading (center-line) 0° up
 N = north-up, true north is 0° up

2 Origin 1 and 2 are located at the stated range and bearing from own ship and provide for two independent sets of variable range markers (VRM) and electronic bearing lines (EBL) originating away from own ship position.

TLL - Target latitude and longitude

Target number, name, position and time tag for use in systems tracking targets.

\$--TLL, xx, 1111.11, a, yyyy.yy, a, c--c, hhmmss.ss, a, a*hh<CR><LF>

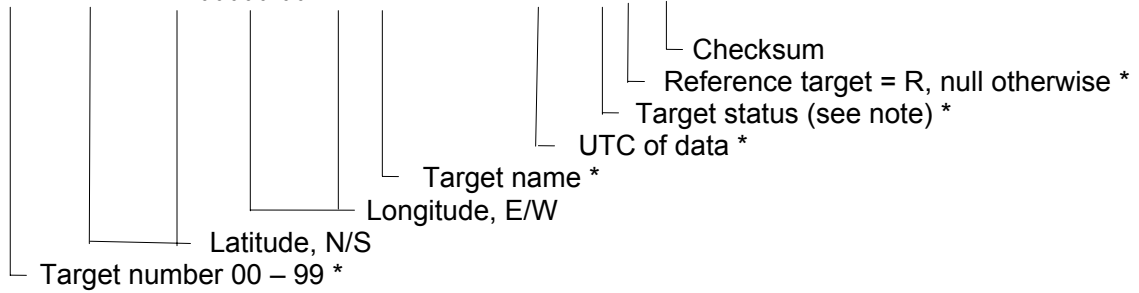

* Not used

NOTE - Target status:

L = lost, tracked target has been lost

Q = query, target in the process of acquisition

T = tracking

TTM - Tracked target message

\$RATTM,xx,x.x,x.x,a,x.x,x.x,a,x.x,x.x,a,c---c,a,a,hhmmss.ss,a*hh<CR><LF>

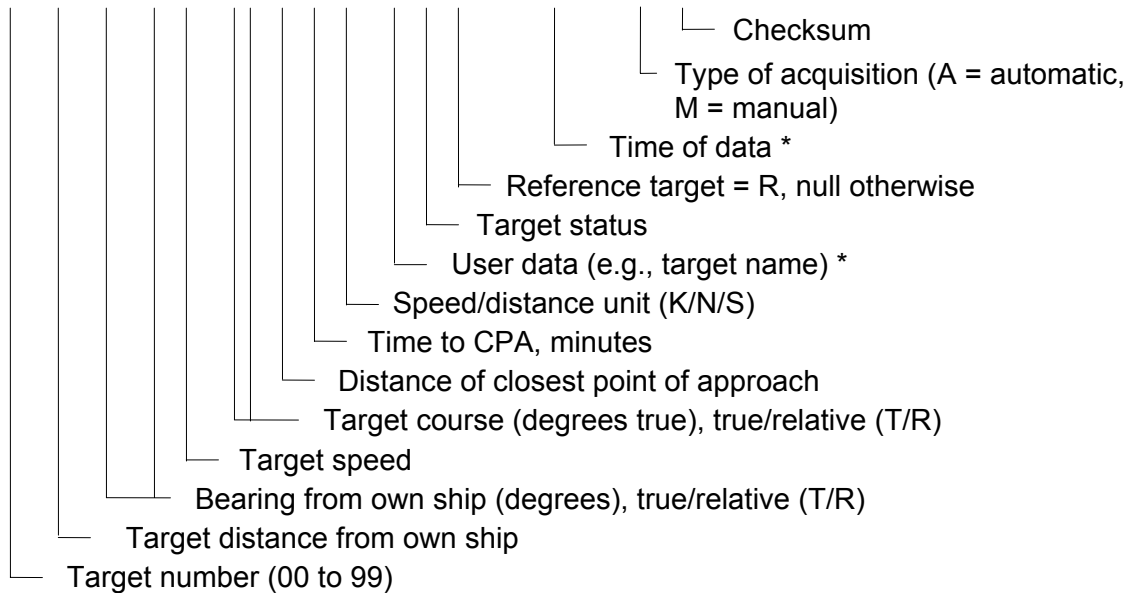

Not used *

VBW - Dual ground/water speed: This sentence to be expanded as shown below:

\$--VBW, x.x, x.x, A, x.x, x.x, A, x.x, A, x.x, A *hh<CR><LF>

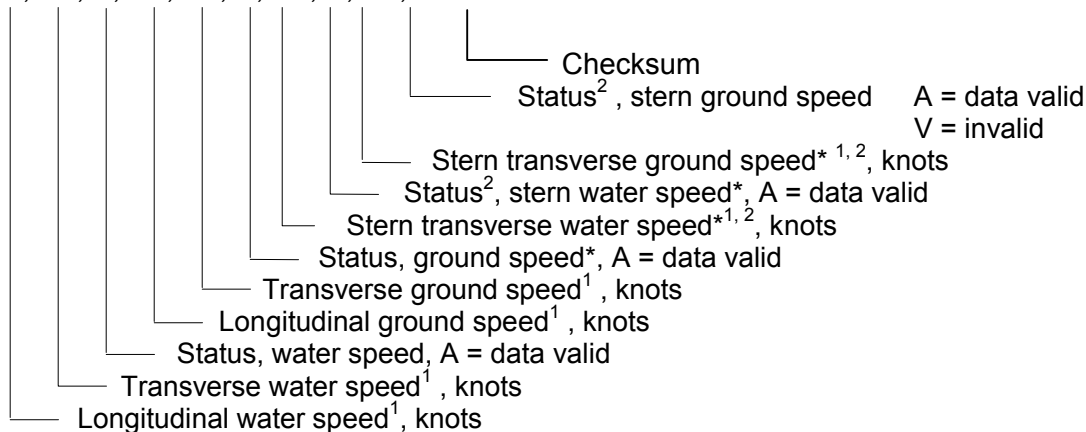

* = Not used

NOTES

1. Transverse speed: “-“ = port, Longitudinal speed: “-“astern.
2. For vessels equipped with dual water and/or ground speed systems ; data for the equipment mounted towards the stern are reported in these fields.

VHW - Water speed (R-type only) and heading

The compass heading to which the vessel points and the speed of the vessel relative to the water.

\$--VHW, x.x, T, x.x, M, x.x, N, x.x, K *hh<CR><LF>

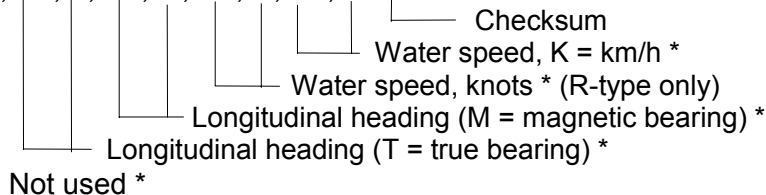

VTG - Course over ground and ground speed (R-TYPE ONLY)

The actual course and speed relative to the ground.

\$--VTG, x.x, T, x.x, M, x.x, N, x.x, K*hh<CR><LF>

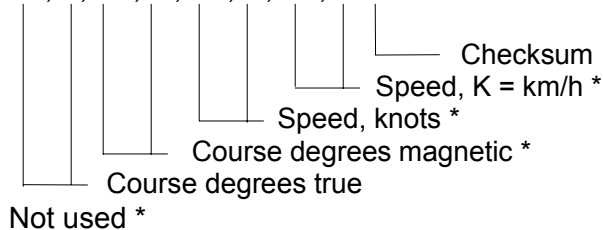

ZDA - Time and date

UTC, day, month, year and local time zone.

\$--ZDA. hhmmss.ss, xx, xx, xxxx, xx, xx*hh<CR><LF>

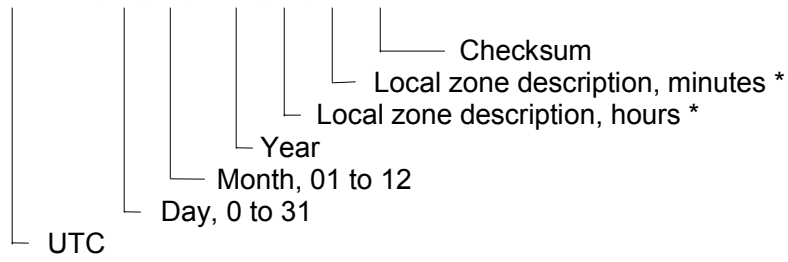

Not used *

LOCAL = UTC + Time difference

9 PARTS LOCATION and PARTS LIST

9.1 ANTENNA UNIT, SCANNER OUTLINE and RF MODULE

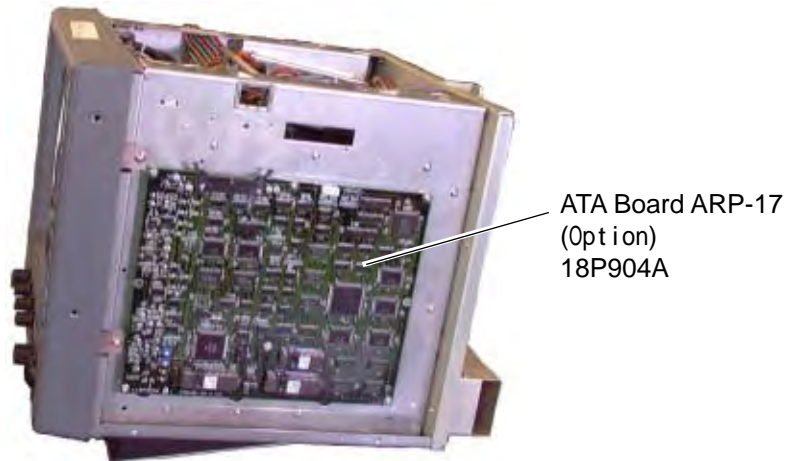

Figure A-1 Display unit, right side view

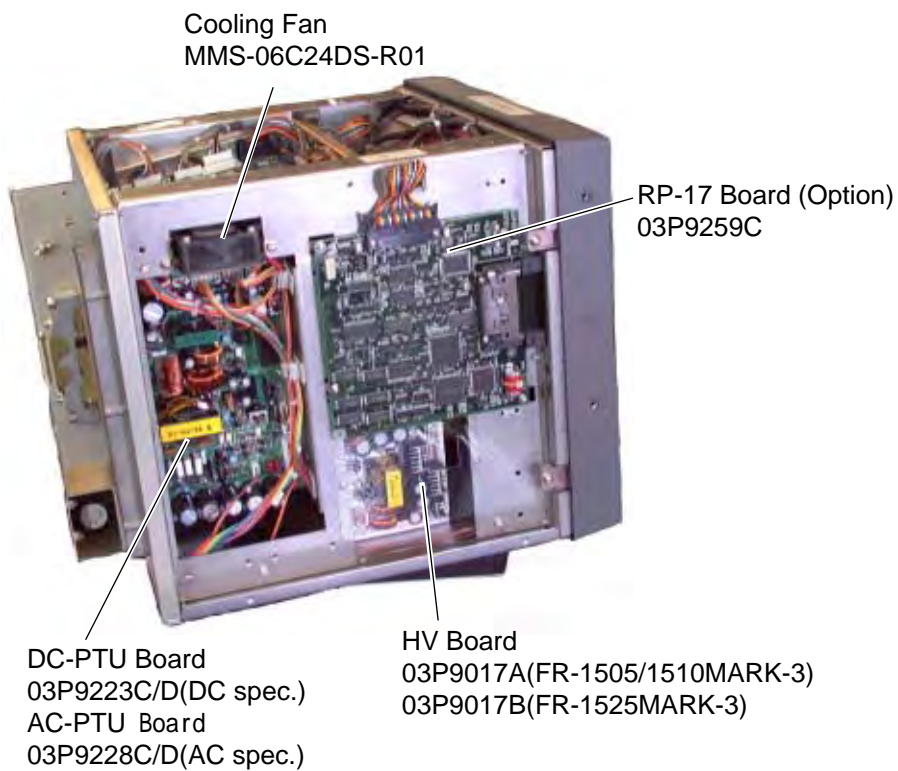

Figure A-2 Display unit, left side view

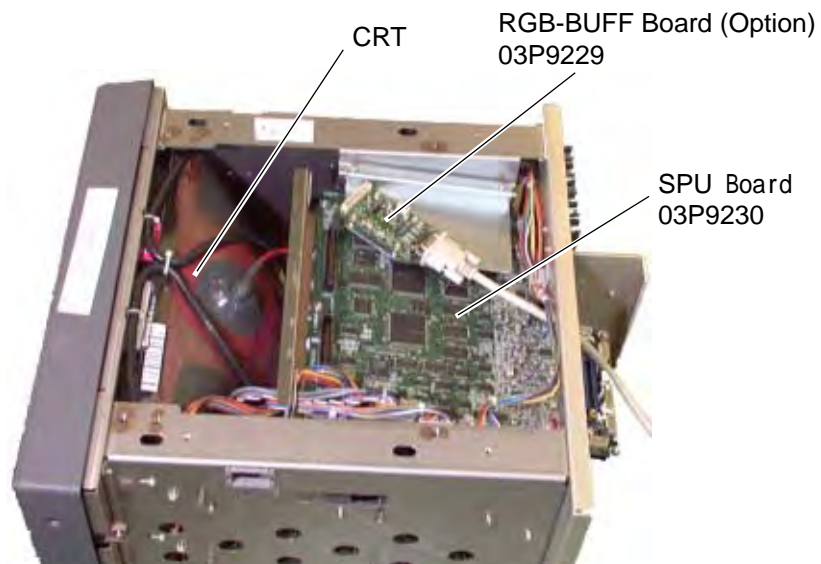

Figure A-3 Display unit, top view

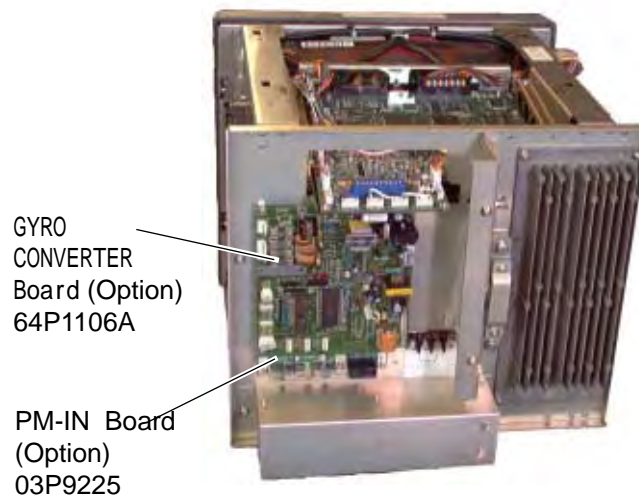

Figure A-4 Display unit, rear view

Figure A-5 Scanner unit

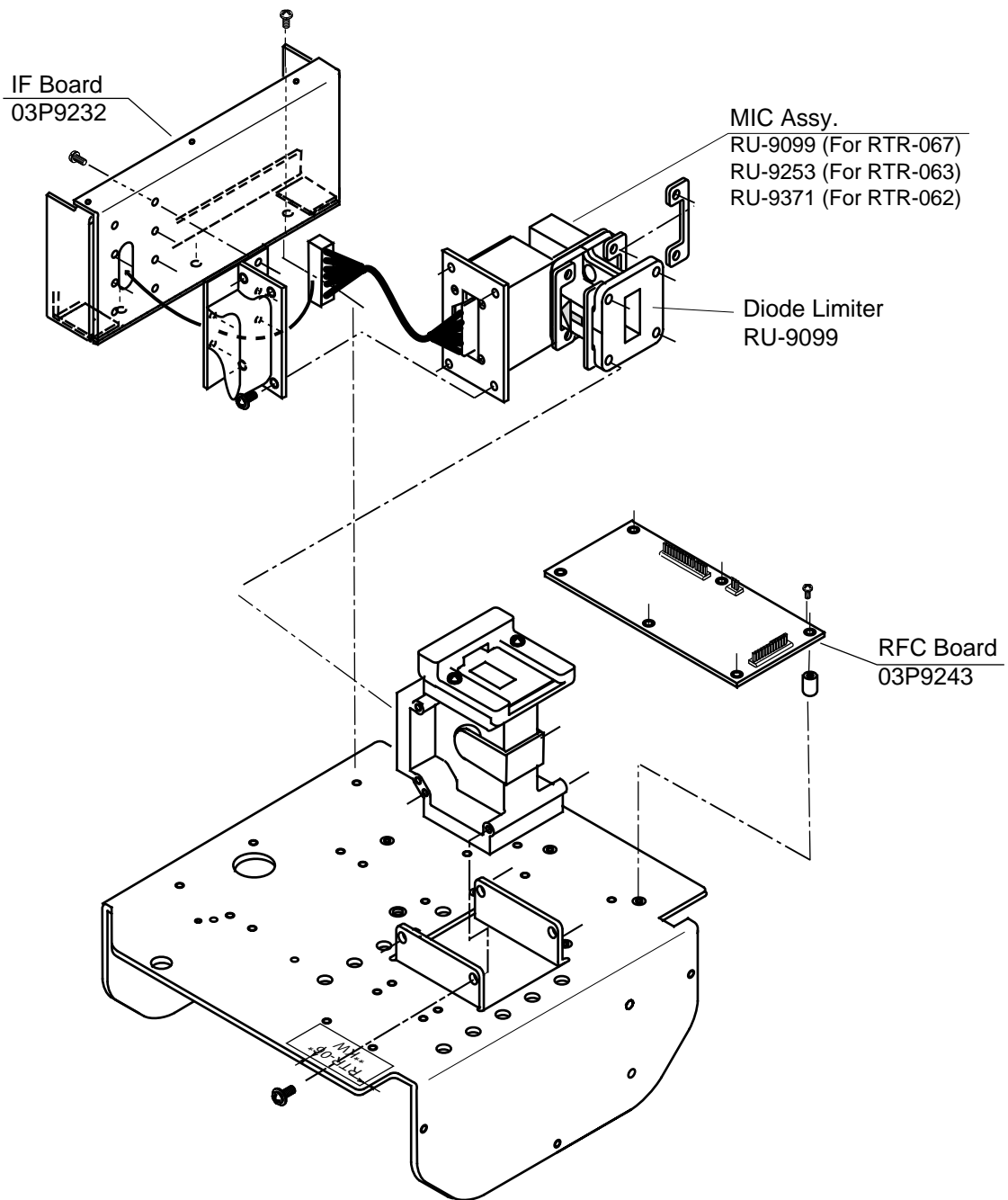

Figure A-6 RF module

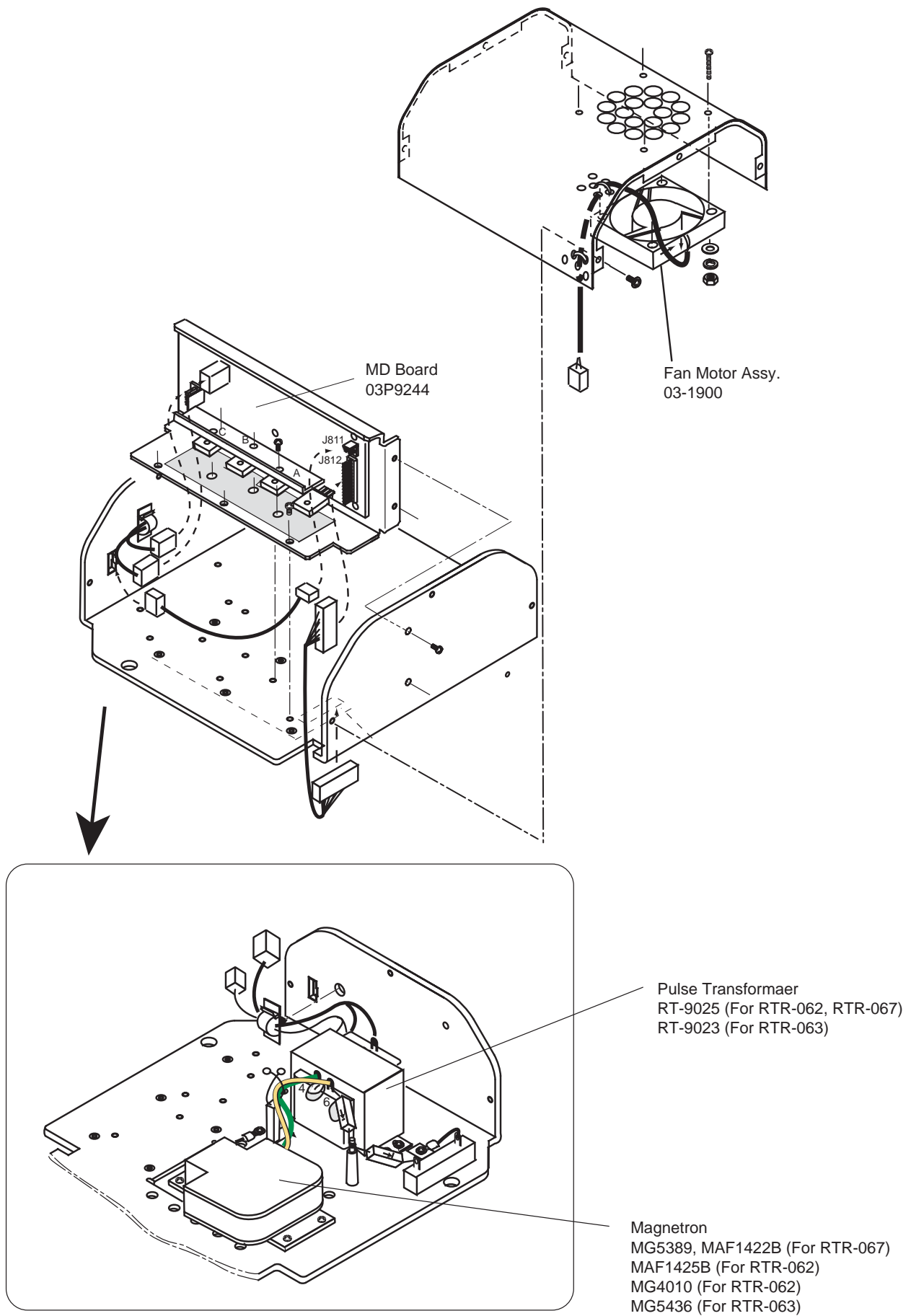
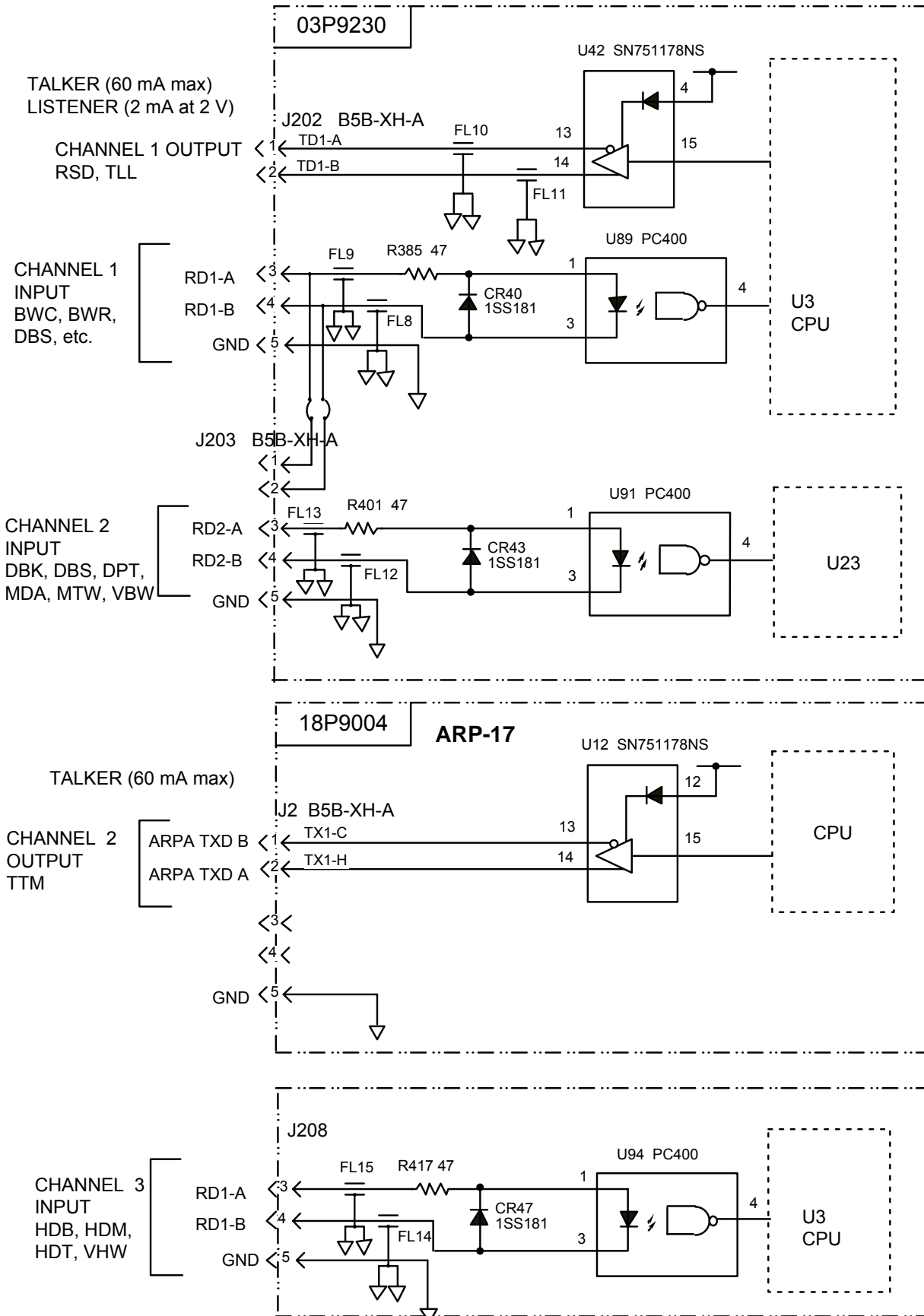

Figure A-7 RF module, rear view

9.2 Circuit diagrams

FR-1500 Mark-3 SERIES SERIAL INTERFACE I/O CIRCUIT



FR-1500 MARK-3 series interfacing diagram

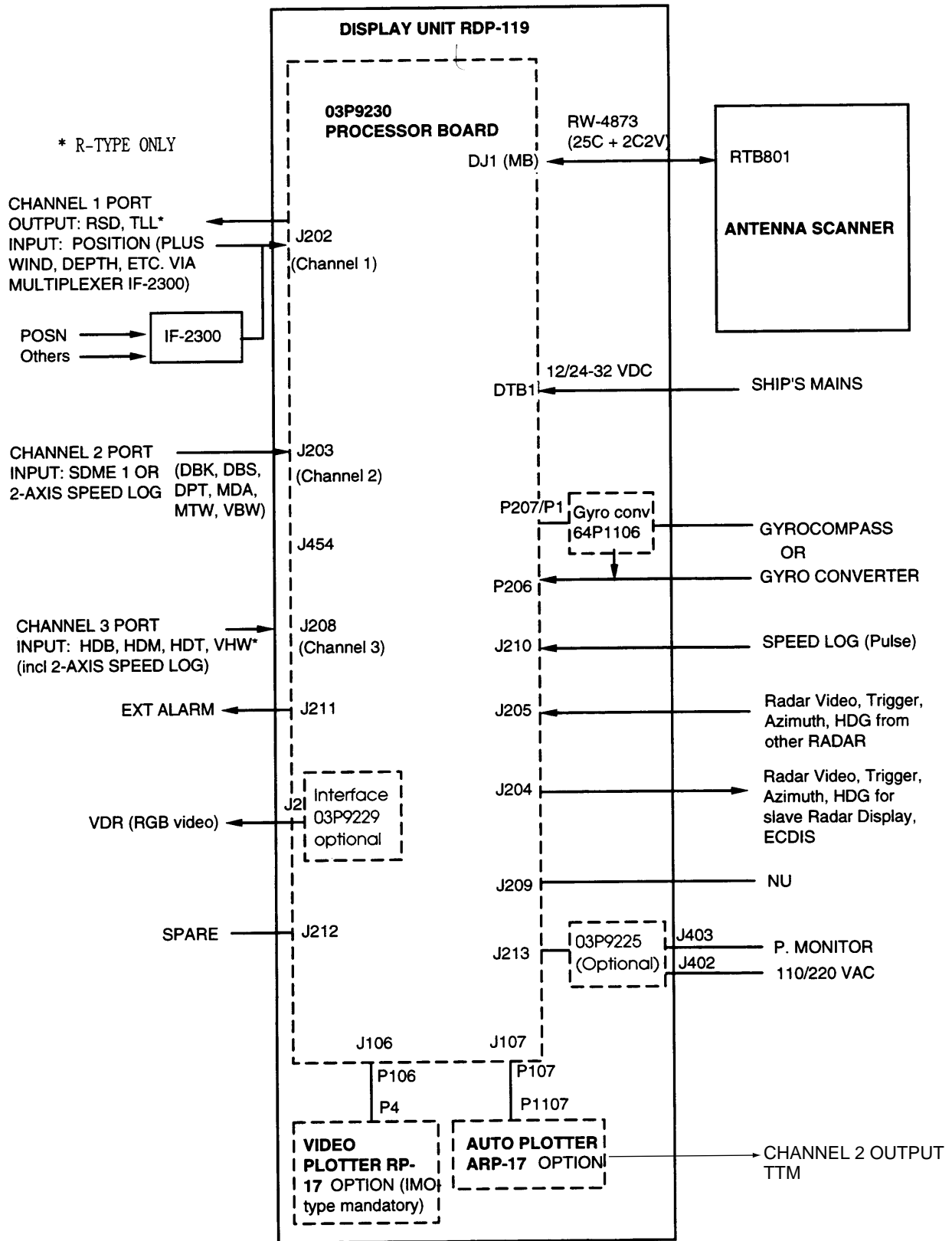

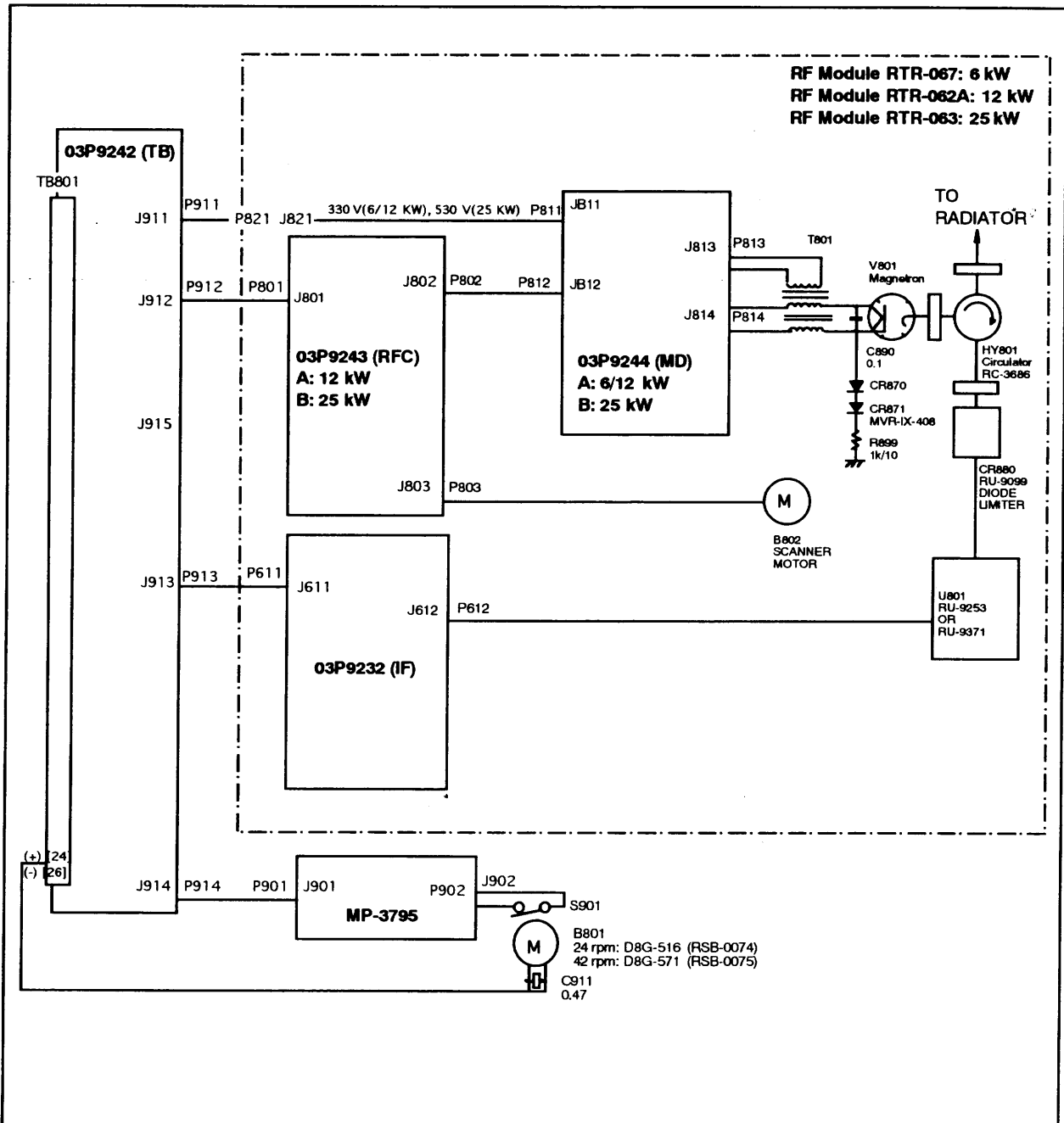

**ANTENNA UNIT
 SCHEMATIC DIAGRAM
 (For more detail, refer to installaiton manual or service manual)**

9.3 Parts list

.1 FR-1505/1515/1525 MARK-3 DISPLAY UNIT RDP-119

FR-2115/2125 ELECTRICAL PARTS LIST 98/5		Unit	DISPLAY UNIT RDP-119	
		Ref. Dwg.	C3464-K02-A	
		Blk. No.		
SYMBOL	TYPE	CODE No.	REMARKS	SHIPPABLE ASSEMBLY
PRINTED CIRCUIT BOARD				
1B4	HV9017A, HV	008-481-630	1505, 1510 M3	X
	HV9017B, HV	008-481-640	1525 M3	X
1B5	03P9230A, SPU	008-490-980		X
4B1	64P1106A, GC	004-412-220	OPTIONAL	X
4B2	03P9259C, RP-17	008-492-900	OPTIONAL	X
4B3	18P9004, ARP-17	008-458-550	OPTIONAL	
	18P9007, ARP-10	008-478-300	OPTIONAL	
CRT ASSEMBLY				
1B8	0A1510	000-141-033		
PANEL ASSEMBLY				
-	RDP-119, PNL/SW	008-490-080	PAF BOARD	X
		008-487-390	English	X
POWER BLOCK ASSY				
	RDP-119-6/10/25 KW	008-490-290	115 VAC	X
	RDP-119-6/10/25 KW	008-490-300	230 VAC	X
	RDP-119-6/10 KW	008-490-270	12 V	X
	RDP-119-10/25 KW	008-490-280	24/32 V	X
FUSE				
F1351	20A		24/32 V MAINS	
	25 A		12 V	
	FGB0 5A		220 V	
FILTER				
FL1	LF-205A	000-588-411	For 115/230 VAC	
FAN ASSY				
	03-1950, FAN-P2P			
SWITCH				
S1	SDDL D	000-129-228	POWER	
S2	S-331	000-474-214	AC UNIT	

Model	FR-2115/2125	Unit	SCANNER UNIT	RSB-0074/0075
ELECTRICAL PARTS LIST 98/5		Ref. Dwg.	C3466-K02-B	
		Blk. NO.		
SYMBOL	TYPE	CODE No.	REMARKS	SHIPPABLE ASSEMBLY
PRINTED CIRCUIT BOARD				
2B2	03P9243A, RFC	008-487-260	6,12 KW	X
	03P9243B, RFC	008-487-280	25 KW	X
2B3	03P9244A, MD	008-487-300	6,12 KW	X
	03P9244B, MD	008-487-320	25 KW	X
2B4	03P9232, IF	008-487-240		X
2B6	03P9242, TB	008-487-230		X
2B7	MP-3795	008-312-370		X
SCANNER CHASSIS				
-	RSB-0074	008-488-010	24 rpm, w/o RF module	X
-	RSB-0075	008-488-030	42 rpm, w/o RF module	X
RF MODULE				
-	RTR-062	008-487-160	10, 12 KW	X
-	RTR-063	008-487-170	25 KW	X
-	RTR-067	008-490-580	6 KW	X
MIC ASSEMBLY				
U801	RU-9253	008-487-350	25 KW	X
	RU-9371	008-487-340	6, 12 KW	X
MOTOR				
B801	D8G-516	000-631-715	24 rpm, w/capacitor	
	D8G-571	000-136-566	42 rpm, w/capacitor	
B802	109P0824H602	000-140-764	25 kW, w/cable	X
SWITCH				
S901	RS-1 NO	000-478-301		
DIODE				
CR870	HVR-1X-40B	000-121-156	10, 12 KW	
	MD-12N1	000-133-735	25 KW	
CR871	HVR-1X-40B	000-121-156	6 KW	
DIODE LIMITER				
CR880	RU-9099	000-126-369		

SYMBOL	TYPE	CODE No.	REMARKS	SHIPPABLE ASSEMBLY
CIRCULATOR				
HY801	RC-3686	000-106-850		
RESISTOR				
R899	ERF-10HMJ102	000-123-395		
TRANSFORMER				
T801	RT-9025	000-123-823	6, 10, 12 KW	
	RT-9023	000-123-394	F25 KW	
MAGNETRON				
V801	M5436	000-140-762	25 kW	
	MAF1425B	000-146-872	12 kW	
	MG4010	000-150-839	12 kW	
	MG5389	000-135-146	6 kW	
	MAF1422B	000-146-871	6 kW	
	MG4006	000-150-838	6 kW	

FURUNO®

FURUNO ELECTRIC CO., LTD.9-52 Ashihara-Cho, Nishinomiya City, 662-8580, Hyogo, Japan
Tel: +81 798-65-2111 Fax: +81 798-65-4200

Pub No. DOC-733

Declaration of conformity

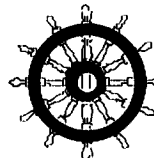

0735

We **FURUNO ELECTRIC CO., LTD.**

(Manufacturer)

9-52 Ashihara-Cho, Nishinomiya City, 662-8580, Hyogo, Japan

(Address)

hereby declare under our sole responsibility that the product

Shipborne radar with ATA, EPA and AIS display types FR-15X5 MARK-3
(for details, see Configuration matrix at page 2/2 of this Declaration)

(Model names, type numbers)

to which this declaration relates conforms to the following standard(s) or normative document(s)

IMO Performance StandardsIMO Resolution A.694 (17)
IMO Resolution A.813 (19)
IMO Resolution MSC.64(67) Annex 4IEC Test standardsIEC 60936-1 Ed. 1.1: 2002-08
IEC/PAS 60936-5 Ed. 1: 2003-09
IEC 60872-2 Ed. 1: 1999-01
IEC 60872-3 Ed. 1: 2000-12
IEC 60945 Ed. 3: 1996-11
IEC 61162-1 Ed. 2: 2000-07

(title and/or number and date of issue of the standard(s) or other normative document(s))

For assessment, see

- EC TYPE EXAMINATION (MODULE B) CERTIFICATE No. 6522/1130/1/2004, and USCG Approval Nos. 165.111/EC0735/1130-1/1/2004 (ATA) and 165.121/EC0735/1130-2/1/2004 (EPA) of 4 October, 2004 issued by Federal Maritime and Hydrographic Agency (BSH), The Federal Republic of Germany
- EC QUALITY SYSTEM (MODULE D) CERTIFICATE No. BSH-022-03-1999/4 of 15 June 2004 and Annex to BSH-022-03-1999/4 of 11 October 2004 issued by Federal Maritime and Hydrographic Agency (BSH), The Federal Republic of Germany

This declaration is issued according to the provisions of European Council Directive 96/98/EC on marine equipment modified by Commission Directive 2002/75/EC.

On behalf of Furuno Electric Co., Ltd.

Hiroaki Komatsu
Manager,
International Rules and RegulationsNishinomiya City, Japan
October 28, 2004

(Place and date of issue)

(name and signature or equivalent marking of authorized person)

Configuration matrix of FR-15X5 MARK-3 series
(This is part of Declaration of conformity DOC-733)

Designation		Type	FR-1505 MARK-3	FR-1510 MARK-3	FR-1525 MARK-3	Remarks
Scanner	XN12AF		x	x	x	4 ft (120 cm), X-band
	XN20AF		x	x	x	6.5 ft (200 cm), X-band
	XN24AF		x	x	x	8 ft (240 cm), X-band
Transceiver	RTR-062			x		12 kW, X-band, TR-up
	RTR-063				x	25 kW, X-band, TR-up
	RTR-067		x			6 kW, X-band, TR-up
Turning unit	RSB-0074		x	x	x	24 rpm
	RSB-0075		x	x	x	42 rpm
Display unit	RDP 119		x	x	x	15" (180 mm) color display
Other mandatory equipment	PM-30		x	x	x	Performance monitor, X-band
	AD-100		x	x	x	Either one of AD-100 (Gyro converter) or GC-8 (Gyro interface)
	GC-8		x	x	x	
	ARP-17		x	x	x	ARPA board (ATA function)
	RP-17		x	x	x	Video plotter board; either one of RP-17 (map function) or RP-180 (AIS information display and map functions)
	RP-180		x	x	x	
Optional equipment	IF-2300					Multiplexer

FURUNO®**FURUNO ELECTRIC CO., LTD.**9-52 Ashihara-Cho, Nishinomiya City, 662-8580, Hyogo, Japan
Tel: +81 798-65-2111 Fax: +81 798-65-4200

Pub NO. DOC-758

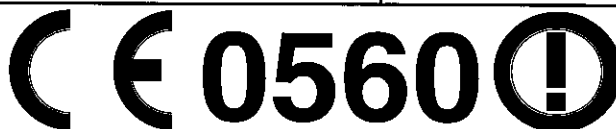
Declaration of ConformityWe **FURUNO ELECTRIC CO., LTD.**

(Manufacturer)

9-52 Ashihara-Cho, Nishinomiya City, 662-8580, Hyogo, Japan

(Address)

declare under our sole responsibility that the product

Shipborne radar – Types: FR-1505 MARK-3 and FR-1510 MARK-3
(See Configuration matrix at page 2/2 of this Declaration for details.)

(Model name, serial number)

are in conformity with the essential requirements as described in the Directive 1999/5/EC of the European Parliament and of the Council of 9 March 1999 on radio equipment and telecommunications terminal equipment (R&TTE Directive) and satisfies all of the following rules, technical standards and recommendations applicable to the product:

EN 60945: 1997-01 (IEC 60945 Third edition: 1996-11)

KSR 142, Annex 1: 1985-10

ITU-R.R. App.S3: 1998, Appendix S3, table 2

(title and/or number and date of issue of the standard(s) or other normative document(s))

For assessment, see

- Statement of Opinion N°: 02214201/AA/00 of 18 September 2002 issued by Telefication, The Netherlands
- Test Reports 98387232 of 15 January 1999 and 98387230 of 18 March 1999 prepared by KTL, The Netherlands
- Test Reports FLI 12-02-041 of 6 September 2002 and FLI 12-98-019 of 11 September 1998 prepared by Furuno Labotech International Co., Ltd.

On behalf of Furuno Electric Co., Ltd.

Hiroaki Komatsu
Manager,
International Rules and RegulationsNishinomiya City, Japan
February 17, 2005

(Place and date of issue)

(name and signature or equivalent marking of authorized person)