

new balance

6.0u



OWNER'S MANUAL

*FOR MAXIMUM EFFECTIVENESS
AND SAFETY, PLEASE READ THIS
OWNER'S MANUAL BEFORE USING YOUR
NEW BALANCE 6.0u UPRIGHT BIKE*

TABLE OF CONTENTS

Important Safety Instructions	2
Unit Warning Labels	3
Specifications & Parts	3
Introduction	4
Assembly Instructions.....	5-8
Getting Started	9
Using Your New Balance 6.0u Upright Bike	9-10
Operating the Computer	11-13
Exercise Guidelines	14
Knowing the Basics.....	14
A Complete Exercise Program	14-15
Aerobic Exercise: How Much? How Often?	15
When to Exercise	15
Measuring Your Heart Rate	15-16
Clothing	16
Tips to Keep You Going.....	16
Heart Rate Target Zone Chart.....	17
Warm Up & Cool Down Stretches	18-19
Care & Storage of Your New Balance 6.0u	20
Workout Progress Charts.....	21-22
Exercise Data Charts.....	23-24

New Balance Fitness Equipment

©2004 Fitness Quest® Inc. All rights reserved. Made in Taiwan.
Fitness Quest, Inc., d/b/a New Balance Fitness Equipment.
New Balance and NB logo are trademarks of New Balance Athletic Shoe Inc.
Fitness Quest® Inc. is the exclusive licensee of New Balance Athletic Shoe Inc.

5/24/04

IMPORTANT SAFETY INSTRUCTIONS

Read all instructions before using this machine

CAUTION:

Exercise of a strenuous nature, as is customarily done on this equipment, should not be undertaken without first consulting a physician. No specific health claims are made or implied as they relate to the equipment.

- 1)** Before starting this or any other exercise program, consult your physician, who can assist you in determining the target heart rate zone appropriate for your age and physical condition. Certain exercise programs or types of equipment may not be appropriate for all people. This is especially important for people over the age of 35, pregnant women, or those with pre-existing health problems or balance impairments.
- 2)** Monitor your heart rate while you exercise and keep your estimated pulse rate within your target heart rate zone. Follow the instructions on pages 15 and 16 in this manual regarding heart rate monitoring and how to determine your appropriate target heart rate zone. When used properly, the heart rate pulse sensors and display monitor provide a reasonably accurate estimate of your actual heart rate. This estimate is not exact and persons with medical conditions and/or a specific need for accurate heart rate monitoring should not rely on the estimations provided.
- 3)** Warm up before any exercise program by doing 8 minutes of aerobic activity, followed by stretching.
- 4)** Wear comfortable clothes that allow freedom of movement and that are not tight or restricting.
- 5)** Wear comfortable shoes made of good support with non-slip soles. Follow the instructions on page 9 for exercising in your bare or sock covered feet.
- 6)** Breathe naturally, never holding your breath during an exercise.
- 7)** Avoid over training. You should be able to carry on a conversation while exercising.
- 8)** After an exercise session, cool down with slow walking and stretching.
- 9)** This machine should not be used by or near children.
- 10)** Handicapped or disabled people must have medical approval before using this machine and should be under close supervision when using any exercise equipment.
- 11)** If you are taking medication which may affect your heart rate, a physician's advise is absolutely essential.
- 12)** Use this machine only for its intended use as described in this manual. Do not use attachments not recommended by the manufacturer.
- 13)** Only one person at a time should use this machine.
- 14)** Do not put hands, feet, or any foreign objects on or near this machine when in use by others.
- 15)** Always use this machine on a level surface.
- 16)** Never operate the machine if the machine is not functioning properly.
- 17)** Start exercise slowly and gradually increase the amount of resistance.
- 18)** If the user experiences dizziness, nausea, chest pain, or any other abnormal symptoms, stop exercise at once and consult a physician immediately.
- 19)** Use caution not to pinch fingers or hands in moving parts when using the unit.
- 20)** Risk of electrical shock. This unit is to be used only indoors and in a dry location.

KEEP THESE INSTRUCTIONS

UNIT WARNING LABELS

Important: See below for placement of the following warning labels on your unit.

WARNING LABEL 1

⚠ WARNING

DO NOT PLUG THE AC ADAPTER INTO WALL UNTIL ELECTRONICS MONITOR IS COMPLETELY ASSEMBLED.

WARNING LABEL 2

⚠ WARNING

FAILURE TO READ AND FOLLOW THE SAFETY INSTRUCTIONS STATED IN THE OWNER'S MANUAL MAY RESULT IN POSSIBLE SERIOUS INJURY OR DEATH. KEEP CHILDREN AWAY. MAXIMUM USER WEIGHT 300 LBS. REPLACE THIS LABEL IF DAMAGED, ILLEGIBLE OR REMOVED.

WARNING LABEL 3

⚠ WARNING

RISK OF ELECTRICAL SHOCK. THIS UNIT IS TO BE USED ONLY INDOORS AND IN A DRY LOCATION.

WARNING LABEL 4

⚠ WARNING

MAKE SURE THE ADJUSTMENT PIN IS LOCKED AND TIGHTENED IN PLACE BEFORE BEGINNING EXERCISES.

SPECIFICATIONS & PARTS

New Balance 6.0u Specifications:

Approximate:

Length: 45-3/4"

Width: 22"

Height: 59"

Product Weight: Approx. 106 lbs.

Maximum User Weight: 300 lbs.

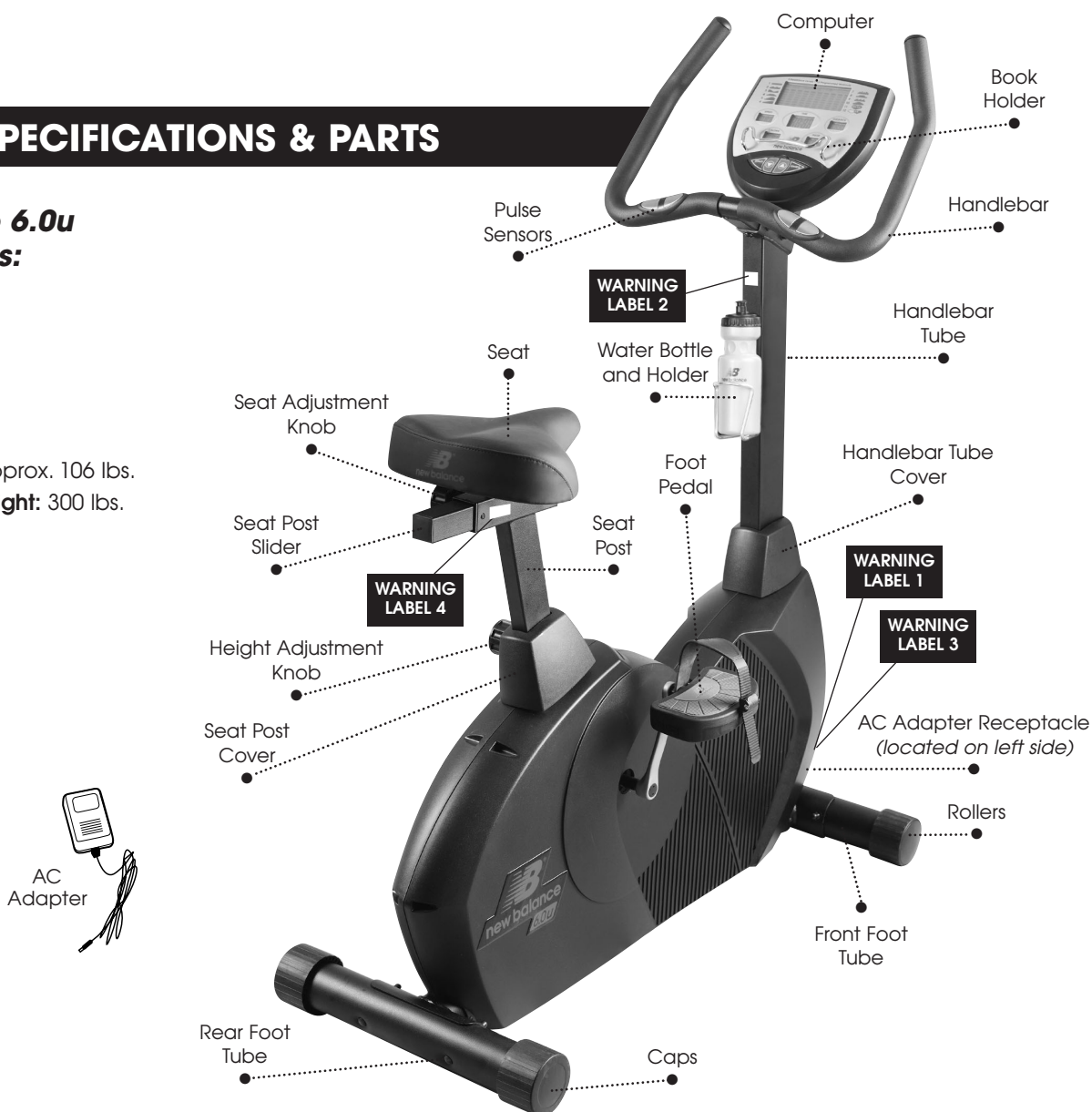

INTRODUCTION

CONGRATULATIONS ON PURCHASING YOUR NEW BALANCE 6.0u UPRIGHT BIKE

With this product in your home, you have everything you need to start your own workout program to tone and firm the major muscle groups of your lower body. This is vital for all of us, regardless of age, sex, or fitness level, and regardless of whether your primary goal is toning, health maintenance, or more energy for daily activities.

Proper exercise, including a low fat diet, strength training and aerobic exercise, tones and conditions the muscles we use every day to stand, walk, lift and turn. It can actually transform our body composition by reducing body fat and increasing the proportion of lean muscle in our bodies. Using the 6.0u Upright Bike will help in reducing body fat and increasing cardiovascular endurance.

Be sure to read through this Owner's Manual carefully.

It is the authoritative source of information about your New Balance 6.0u Upright Bike.

Retain this manual for future reference.

COMMENTS OR QUESTIONS

Dear Customer,

Congratulations on your purchase of the New Balance 6.0u Upright Bike.

We're sure that you will be completely satisfied with the product and we invite your comments so that we can hear about your success.

Please write or call our Customer Service Specialists at the address or phone number listed below, or contact us by email or on our web site, with any comments or questions you may have.

**New Balance 6.0u
Customer Service Department
1400 Raff Road SW, Canton OH 44750-0001**

1-800-292-5009, Monday through Friday
9:00am to 5:00pm, Eastern Standard Time

Email: customersupport@fitnessquest.com

www.newbalancefitness.com

ORDERING MISSING OR DEFECTIVE PARTS

When ordering parts, always provide the following information:

- 1) Name, Mailing Address and Telephone Number
- 2) Date of Purchase
- 3) Where Product was Purchased
(Name of Retail Store, City)
- 4) Model Number (NBP01060-2)
- 5) Part Order Number and Description

All details depicted in this Owner's Manual, and of the product itself, are subject to change without notice.

ASSEMBLY INSTRUCTIONS

Occasionally our products contain components that are pre-lubricated at the factory. We recommend that you protect flooring, or anything else the parts may contact, with newspaper or cloth.

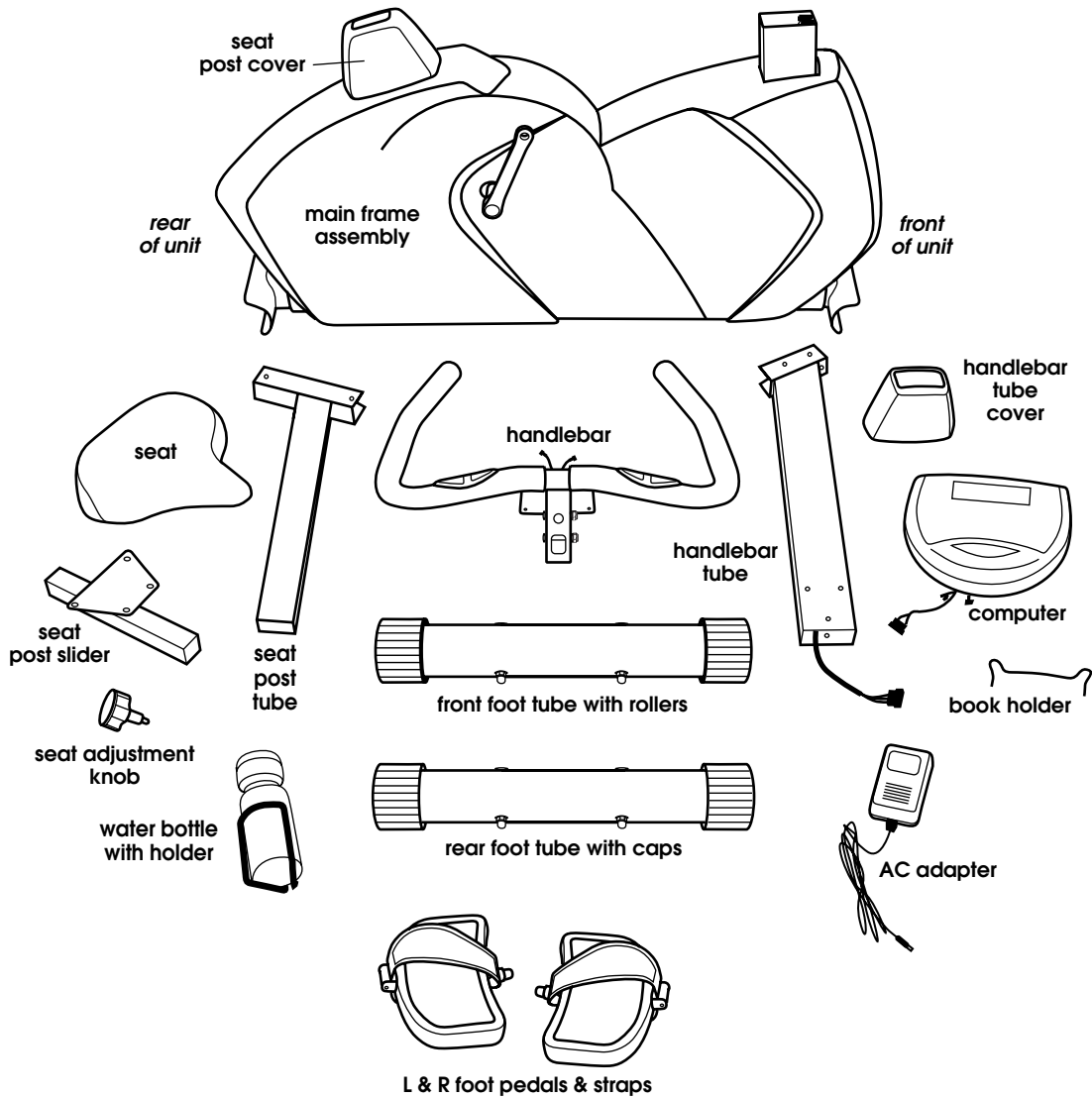

Tools Required: (included)

Multi Hex Tool with
Phillips Screwdriver

Allen Wrench

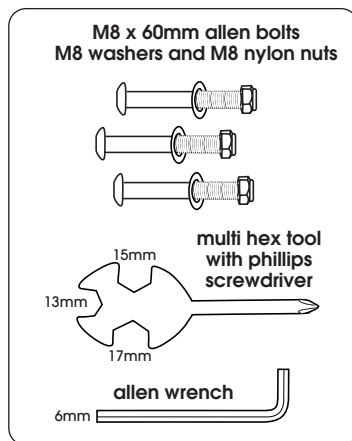

Fastener Pack

STEP 1 - Foot Tube Assembly

Remove the two Carriage Bolts, Washers and Nylon Nuts from both the Front Foot Tube with Rollers and the Rear Foot Tube with Caps.

Align the Rear Foot Tube with the rear of the Main Frame Assembly. Make sure the square holes in the Rear Foot Tube are on the outside. Insert Bolt through the Rear Foot Tube and Main Frame Assembly. Secure with Washers and Nuts you just removed. Tighten with the Wrench provided.

Repeat on the front of the unit using the **Front Foot Tube with Rollers**.

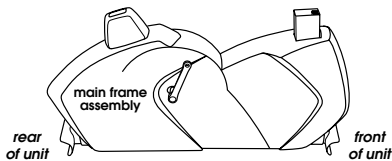
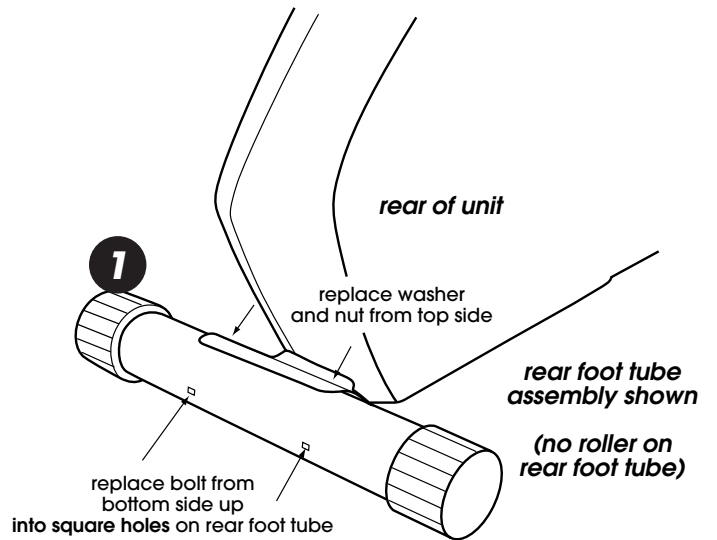

STEP 2 - Seat Assembly

- Lay the Seat upside down. Remove the four Nuts and Washers on the underside of the Seat. Place the Seat Post Slider over the Bolts on the back of the Seat. Replace the Washers and Nuts. Tighten with the Wrench provided.
- Slide the Seat Post into the rear of the Main Frame by loosening the Height Adjustment Knob (aligning the holes with the adjustment Knob). Once in position, turn the Height Adjustment Knob to tighten it.
- Slide the Seat Post Slider into the Seat Post making sure the Seat is facing forward.
- Insert the Seat Adjustment Knob into the hole on the Seat Post and tighten into place. **Make sure the Seat Post Slider is pushed into the Seat Post far enough for the Seat Adjustment Knob to "catch" into the slot on the Seat Post Slider.**

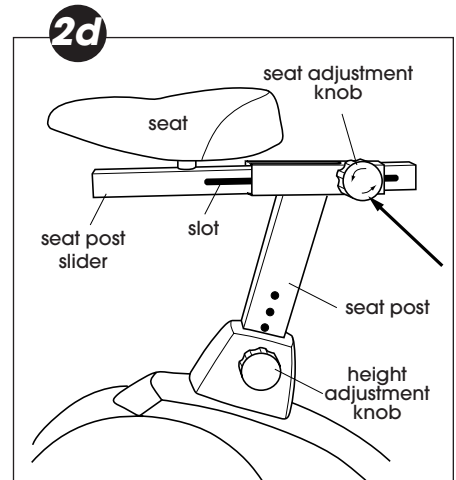
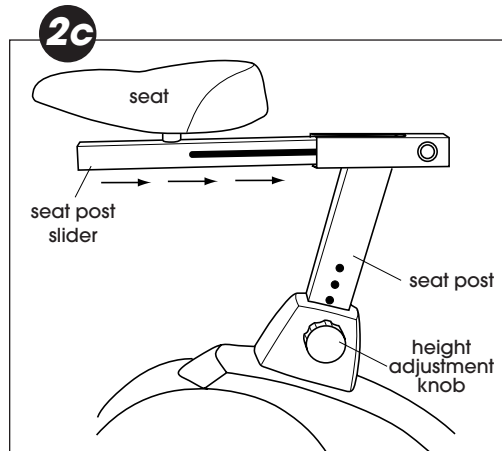
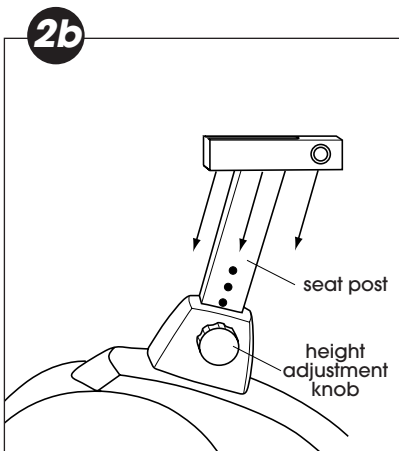
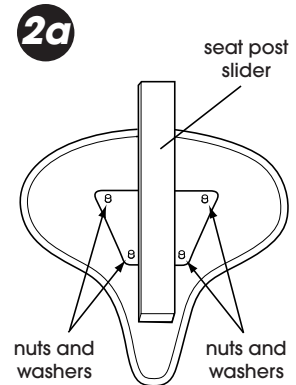

STEP 3 - Handlebar Tube Assembly

- Remove the two Allen Bolts, Washers and Phillips Screw from the front of the Handlebar Tube.
- Slip the Handlebar Tube Cover onto the Handlebar Tube as shown.
- Remove the wire tie from the wires inside the neck of Main Frame Assembly where the Handlebar Tube will go. Attach the three wires from the Main Frame Assembly to the three wires coming out the bottom of the Handlebar Tube. **Handlebar Tube should angle down towards the front of the unit.**
- Insert the Handlebar Tube into the neck of the Main Frame Assembly tucking the wires down into the Main Frame Assembly. **Be careful not to pinch the wires. Gently pull the wires up from the top of the Handlebar Tube to prevent any slack in the wires at the base of the Handlebar Tube.**
- Secure the Handlebar Tube in place with the three Carriage Bolts, Washers and Nylon Nuts from the fastener pack. Tighten with the Wrench provided. Reinsert the Bolts and Washers you removed in (a). Tighten with the Allen Wrench provided.
- Let the Handlebar Tube Cover slip into place. Push it down gently until it clicks. Secure with the Phillips Screw you removed in (a) and tighten.

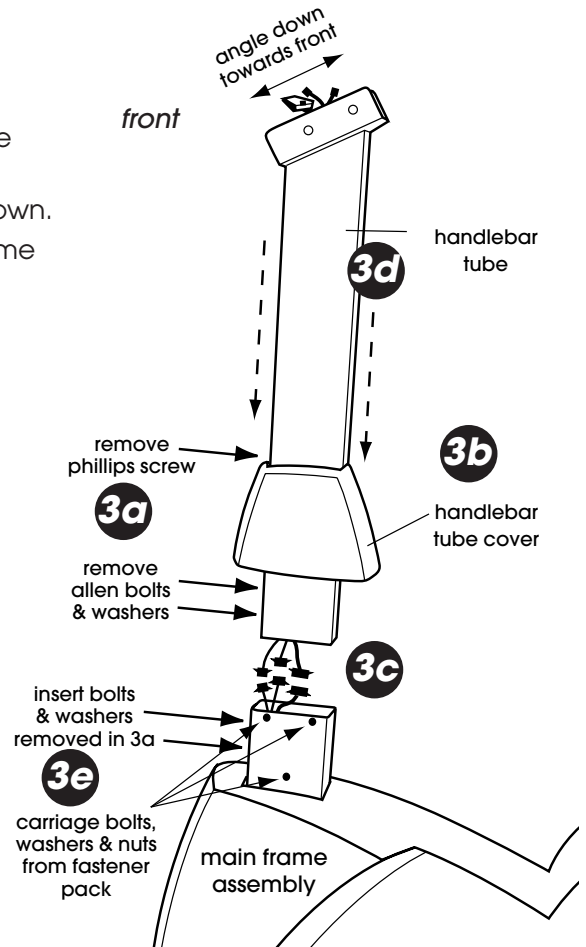
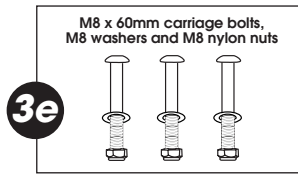

STEP 4 - Foot Pedal Assembly

The Foot Pedals and the Foot Pedal Cranks are marked "L" and "R".

Using the Wrench provided, attach the **Left** Foot Pedal to the **Left** Crank rotating the Wrench **counter-clockwise**. **Do not try to turn clockwise. You will strip the threads.**

Attach the **Right** Foot Pedal to the **Right** Crank rotating the Wrench **clockwise**.

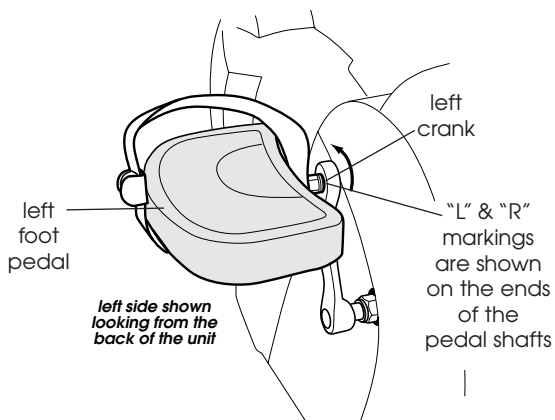

STEP 5 - Handlebar Assembly

- Remove the two Allen Bolts, Washers and Nuts from Handlebars. Also, remove the Allen Bolt on the underside of the Handlebar.
- Feed the wires up through the base of the Handlebar so they come out the top.
- Place Handlebars into "U" on the top of the Handlebar Tube. Remove the Nut Caps. Replace and tighten the three Allen Bolts, Washers and Nylon Nuts you just removed with the Wrench provided. Replace the the Nut Caps.

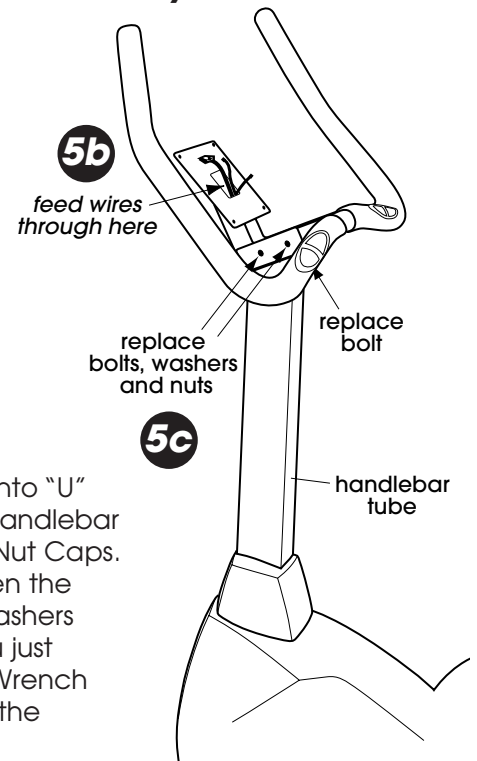

STEP 6 - Computer Assembly

- Remove the four Phillips Bolts from the back of the Computer.
- Snap together Connectors for Computer, tucking the Wires inside the Handlebar Tube. **Be careful not to pinch the wires.** The Book Holder can be attached to the Computer at any time.
- Attach the Computer using the four Phillips Bolts you removed in step (a). Tighten with the Screwdriver provided.
- Remove Battery Door on the back of the Computer.
Insert four "C" Batteries (included) in numbered order and replace Battery Door.

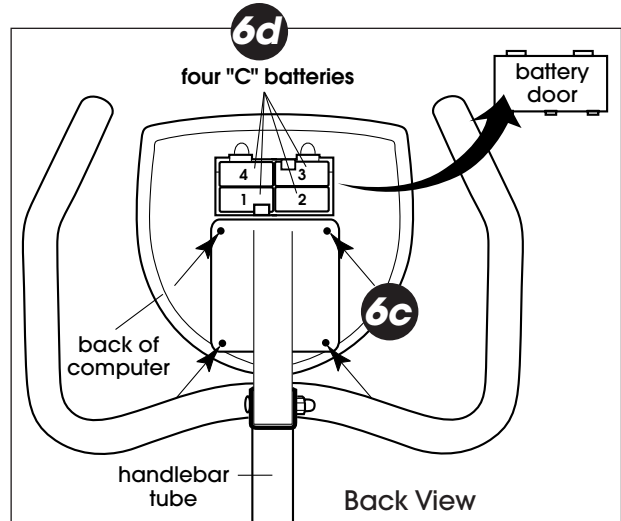
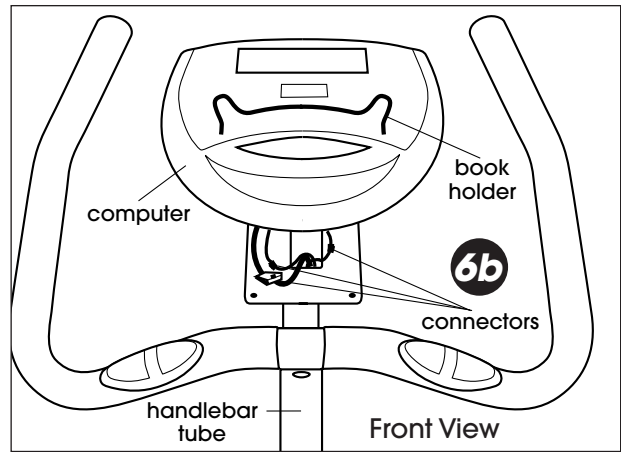

STEP 7 - Water Bottle Holder Assembly

Remove Phillips Screws from Handlebar Tube. Line up Water Bottle Holder and attach to the Handlebar Tube by re-inserting Phillips Screws and tightening them with the Screwdriver provided.

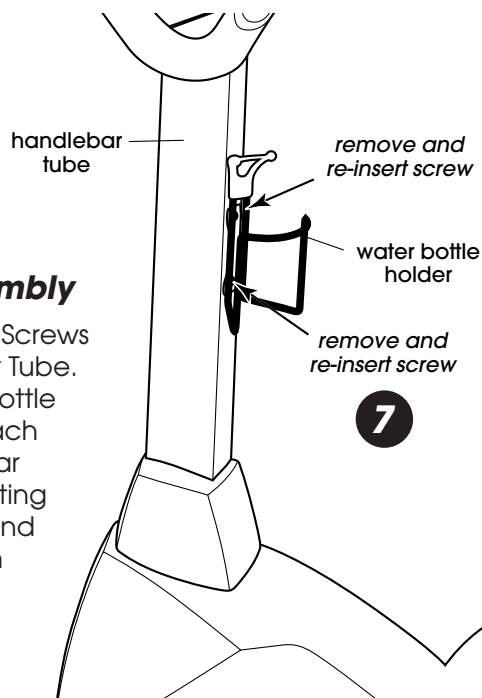

STEP 8 - AC Adapter

Insert AC Adapter into front of Unit, then plug into wall.

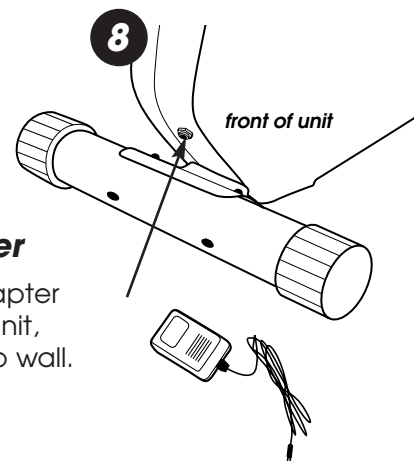

Assembly is now complete.

IMPORTANT:
Please read pages 9-10 before beginning your workout for important instructions on how to use your New Balance 6.0u Upright Bike.

GETTING STARTED

Once your New Balance 6.0u Upright Bike is assembled, make sure that your workout space has a solid, level surface with plenty of space around it. We recommend placing a mat under your unit to protect your flooring.

Correct Workout Position

When exercising, you can either keep your back upright or lean forward by resting your forearms on the front handlebars. When pedaling do not lock out your knees, at the bottom of the pedaling motion there should be a slight bend in the knee. Keep your head in a neutral position to minimize neck and upper back strain. Always try to pedal the bike with a smooth and rhythmic motion.

USING YOUR NEW BALANCE 6.0u UPRIGHT BIKE

⚠ WARNING

RISK OF ELECTRICAL SHOCK. THIS UNIT IS TO BE USED ONLY INDOORS AND IN A DRY LOCATION.

The New Balance 6.0u, provides a completely smooth and natural feeling that minimizes the impact on your hips, knees and ankles while providing a superior aerobic and muscle toning workout. The durable steel frame and front transport wheels make the unit mobile and easy to use.

IMPORTANT:

- This unit is not recommended for children.
- Always make sure that you feel balanced and secure.
- Always use your machine on a clean, solid and level surface.

DUAL SIDED PEDAL

The New Balance 6.0u has a dual side pedal. The top side of the pedal is to be used with shoes and the bottom smooth side of the pedal is meant to be used with a bare or sock covered foot.

To use the bottom side of the pedal gently nest the balls of your feet into the pedal contour. You may have to try sliding your foot forward and backward before you feel it nest into the pedal. Once your foot is comfortably aligned with the pedal contour, tighten the strap so it is firmly around the foot.

Top Side of Pedal

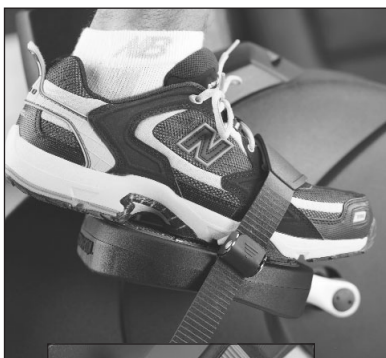

Bottom Side of Pedal



USING THE PULSE FUNCTION ON THE FRONT HANDLEBARS

The Pulse window on your computer works in conjunction with the pulse sensors found on the front handlebars. When you are ready to read your pulse:

- 1) Place **both** hands firmly on the pulse sensors. For the most accurate reading, it is important to use **both** hands.
- 2) Look at your pulse window. The small heart will begin to blink.
- 3) Your estimated heart rate will appear in the window approximately 6 seconds after you grasp the pulse sensors.
- 4) Refer to the Target Heart Rate Zone Chart found on page 17 of this manual. For additional information about the importance of working within certain heart rate ranges, see page 15 and 16 – *Measuring Your Heart Rate*.
- 5) This estimate is not exact and persons with medical conditions and/or a specific need for accurate heart rate monitoring should not rely on the estimations provided.



OPERATING THE COMPUTER

WARNING

The batteries must be installed as instructed on page 8. Do not carry batteries loosely, such as in a purse or pocket. The batteries may explode or leak and cause injury if installed improperly, misused, disposed of in a fire or recharged.

WARNING

Do not plug AC Adapter into wall until computer is completely assembled.



Introduction

Your unit is equipped with a programmable computer to help you track your progress and motivate you to reach your fitness goals.

This computer provides different programs designed to tailor to your fitness goals. Simply choose the program you like, set the time limit and begin exercising. Your monitor will then show your approximate pulse, approximate calories burned, elapsed time, speed and distance traveled.

Functions and Features

QUICK START BUTTON: Allows you to start the computer without selecting a program. TIME automatically begins to count up from zero. Use the ▲ UP and ▼ DOWN buttons to adjust the resistance.

TIME: Shows your elapsed workout time in minutes and seconds. Your computer will automatically count up from 0:00 to 99:59 in one second intervals. You may also program your computer to count down from a set value by using the ▲ UP and ▼ DOWN buttons. If you continue exercising once the time has reached 0:00, the computer will begin beeping, and reset itself to the original time set, letting you know your workout is done.

SPEED: Displays your workout speed in miles per hour.

DISTANCE: Displays the accumulative distance traveled during each workout up to a maximum of 99.9 miles. The distance will be displayed in tenths of a mile.

CALORIES (approximate): Your computer will estimate the cumulative calories burned at any given time during your workout. Calorie expenditure on your computer is based on realistic expectations;

however, your computer is not individually programmable for all necessary variables to accurately monitor actual calories burned.

The computer will count up in 0.1 increments. After the display value reaches 999, it will reset to "0" and begin counting from 0.1 again.

AGE: Your computer is age-programmable from 10 to 99 years when you choose Program 11 or Program 12.

Note: This unit is not recommended for children.

The age function is only adaptable to Program 11 or Program 12.

If you do not set an age, this function will always default to age 25.

PULSE (approximate): Your computer displays your pulse rate in beats per minute during your workout.

Pulse sensors, located on the handlebars enable the user to read his/her pulse rate. By grasping the sensors and holding firmly, the display will read your pulse rate in the display window. Your pulse will continue to read as long as your hands stay on the pulse sensors.

When used properly, the heart rate pulse sensors and display monitor provide a reasonably accurate estimate of your actual heart rate. This estimate is not exact and persons with medical conditions and/or a specific need for accurate heart rate monitoring should not rely on the estimations provided.

(continued on next page)

Buttons and Definitions

ENTER: This button allows users to set the Program and Time on Programs 1-10 and Time and Age on Programs 11-12.

START: This button allows the user to STOP or START exercising. (By holding this button for two seconds the user can reset all values to "0"). The computer will turn off automatically after approx. 4.5 minutes of non use. All values will then be reset to "0".

▲ UP BUTTON: This button allows the user to increase the values of the Tension Level, Time, Age and Program.

▼ DOWN BUTTON: This button allows the user to decrease the values of the Tension Level, Time, Age and Program.

LCD Workout Graphics

This system offers 12 programs that you can preset the workout time and will divide the time by 10 intervals. If you do not preset the workout time the system will count up the workout time in one-second increments.

Programs 1-10:

See LCD Workout Graphics on next page.

STEP 1 – Begin by pressing the START button for over two seconds. This will clear any other chosen function.

STEP 2 – Next press the ▲ UP or ▼ DOWN buttons to scroll to the desired exercise program.

STEP 3 – To set TIME, press the ENTER button and use the ▲ UP and ▼ DOWN buttons. If you want the TIME to count up from zero, press ENTER to move to the next step.

STEP 4 – Press the START button to begin exercising. (If you want to exit the Program, press the START button for two seconds and the display will reset.)

Once you begin exercising, your present workout interval will be flashing. You can also increase or decrease your workout resistance by pressing the ▲ UP or the ▼ DOWN button. To PAUSE your exercising program, press the START button, then to resume, press the START button again.

Programs 11 and 12:

These unique programs allow the monitor to adjust the workout resistance according to your heart rate automatically. Grasp the pulse sensors and hold with a firm grip. If the current Heart Rate is greater than the Target Heart Rate, the computer will decrease the workout resistance automatically. If your current Heart Rate is less than your Target Heart Rate it will increase your resistance. By the resistance changing, the machine will be able to keep your heart rate at its target beats per minute.

When used properly, the heart rate pulse sensors and display monitor provide a reasonably accurate estimate of your actual heart rate. This estimate is not exact and persons with medical conditions and/or a specific need for accurate heart rate monitoring should not rely on the estimations provided.

Important: You must keep your hands on the pulse sensors throughout the entire workout when using Programs 11 and 12.

Important: Be sure to set your actual age when using these programs.

Program 11: is designed to allow you to work out at 60% of maximum heart rate (Target Heart Rate)

Program 12: is designed to allow you to work out at 85% of maximum heart rate (Target Heart Rate)

Operating Instructions for Programs 11 and 12

STEP 1 – Press START button for two seconds to clear out previous program.

STEP 2 – Press the ▲ UP or ▼ DOWN button to choose the desired Heart Rate Program (Program 11 or 12).

STEP 3 – Press ENTER for TIME mode. Press the ▲ UP or ▼ DOWN button for the desired TIME setting.

STEP 4 – Press ENTER for AGE mode. Press the ▲ UP or ▼ DOWN button for the desired AGE setting.

STEP 5 – Press the START button. You are now ready to begin exercising.

LCD Workout Graphics

PROGRAM 1

MANUAL

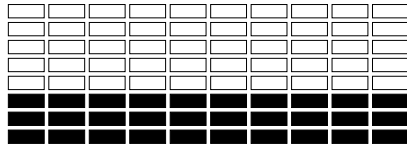

PROGRAM 5

FAT BLASTER INCLINE

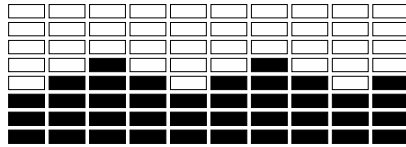

PROGRAM 9

PEAKS AND VALLEYS

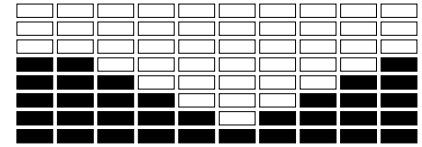

PROGRAM 2

ROLLING HILLS

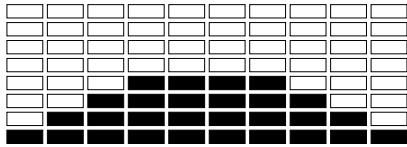

PROGRAM 6

SUPER SLOW INCLINE

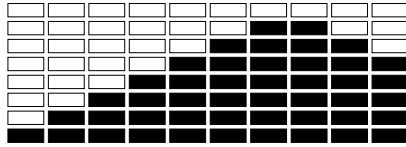

PROGRAM 10

OVER THE HILL

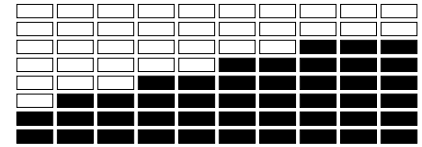

PROGRAM 3

SHAPE UP VALLEY

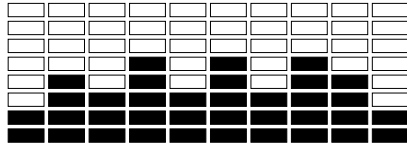

PROGRAM 7

RANDOM ENERGY

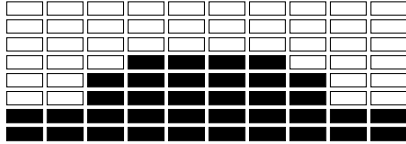

PROGRAM 11

60% OF TARGET HEART RATE

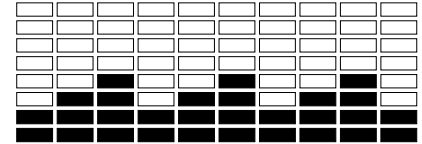

PROGRAM 4

CARDIO PLATEAU

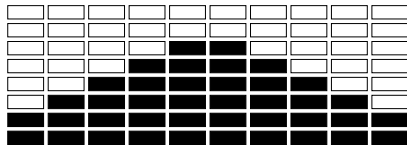

PROGRAM 8

CARDIO PLATEAU 2

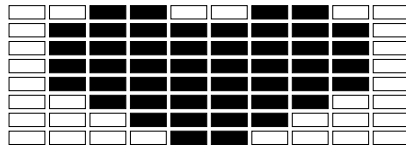

PROGRAM 12

85% OF TARGET HEART RATE

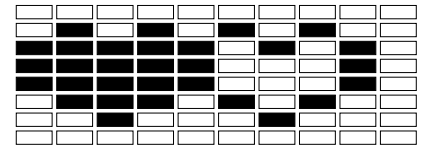

LCD Contrast Calibration

The contrast of the screen can be adjusted by the following steps:

- During the STOP mode, press and hold the ENTER and ▲ UP buttons together for over two seconds. You will hear a faint beep. This will open the LCD contrast calibration mode.
- Then press the ▲ UP or ▼ DOWN button to adjust the contrast of the screen. Press START button to set the desired level of contrast. There are 16 levels of contrast.

EXERCISE GUIDELINES

IMPORTANT

Please review this section before you begin exercising.

IMPORTANT:

If you are over 35 and have been inactive for several years, you should consult your physician, who may or may not recommend a graded exercise test.

If you are just beginning your exercise program, your target heart rate range should be roughly at 60% of your maximum heart rate. As you become more conditioned (or if you are already in good cardiovascular shape) you can increase your target heart rate to 70%-85% of your maximum heart rate. Remember, your target heart rate is only a guide.

You should also consult your physician if you have the following:

- High blood pressure
- High cholesterol
- Asthma
- Heart trouble
- Family history of early stroke or heart attack deaths
- Frequent dizzy spells
- Extreme breathlessness after mild exertion
- Arthritis or other bone problems
- Severe muscular, ligament or tendon problems
- Other known or suspected disease
- If you experience any pain or tightness in your chest, an irregular heartbeat or shortness of breath, stop exercising immediately. Consult your physician before continuing.
- Pregnant
- Balance Impairment
- Taking medications that affect heart rate

KNOWING THE BASICS

Physical fitness is most easily understood by examining its components, or "parts".

There is widespread agreement that these five components comprise the basics of physical training:

CARDIORESPIRATORY ENDURANCE – the ability to deliver oxygen and nutrients to tissues, and to remove wastes, over sustained periods of time. Using your New Balance 6.0u will improve this.

MUSCULAR STRENGTH – the ability of a muscle to exert force for a brief period of time. Upper-body strength, for example, can be measured by various weight-lifting exercises.

MUSCULAR ENDURANCE – the ability of a muscle, or a group of muscles, to sustain repeated contractions or to continue applying force against a fixed object. Push ups are often used to test endurance of arm and shoulder muscles.

FLEXIBILITY – the ability to move joints and use muscles through their full range of motion. The sit-and-reach test is a good measure of flexibility of the lower back and backs of the upper legs.

BODY COMPOSITION – often considered a component of fitness. It refers to the makeup of the body in terms of lean mass (muscle, bone, vital tissue and organs) and fat mass. An optimal ratio of fat to lean mass is an indication of fitness, and the right types of exercises will help you decrease body fat and increase or maintain muscle mass. To help track your progress we have provided Workout Progress Charts on pages 21 and 22.

A COMPLETE EXERCISE PROGRAM

How often, how long and how hard you exercise, and what kinds of exercises you do should be determined by what you are trying to accomplish. Your goals, your present fitness level, age, health, skills, interest and convenience are among the factors you should consider. For example, an athlete training for high-level competition would follow a different program than a person whose goals are good health and the ability to meet work and recreational needs.

Your exercise program should include something from each of the four basic fitness components

described previously. Each workout should begin with a warm up and end with a cool down. As a general rule, space your workouts throughout the week and avoid consecutive days of hard exercise.

Here are the amounts of activity necessary for the average healthy person to maintain a minimum level of overall fitness. Included are some of the popular exercises for each category.

WARM UP – 5-10 minutes of exercise such as walking, slow jogging, knee lifts, arm circles or trunk rotations. Low intensity movements that simulate movements to be used in the activity can also be included in the warm up.

MUSCULAR STRENGTH – a minimum of two, 20 minute sessions per week that include exercises for all the major muscle groups. Lifting weights is the most effective way to increase strength.

MUSCULAR ENDURANCE – at least three, 30 minute sessions each week that include exercises such as calisthenics, push ups, sit ups, pull ups, and weight training for all the major muscle groups.

CARDIORESPIRATORY ENDURANCE – at least three, 20 minute workouts of continuous aerobic exercise each week. Working out on your New Balance 6.0u Upright Bike is a good way to obtain this aerobic activity. Other popular aerobic conditioning activities include brisk walking, jogging, swimming, cycling, rope jumping, rowing, cross-country skiing, and some continuous action games like racquetball and handball.

FLEXIBILITY – 10-12 minutes of daily stretching exercises performed slowly, without a bouncing motion. This can be included after a warm up or during a cool down. Refer to pages 18 and 19 for a list of total body stretches.

COOL DOWN – a minimum of 5-10 minutes of slow walking or lower intensity elliptical exercise, combined with stretching.

AEROBIC EXERCISE: HOW MUCH? HOW OFTEN?

Experts recommend that you do some form of aerobic exercise at least three times a week for a minimum of 20 continuous minutes. Of course, if that is too much, start with a shorter time span and gradually build up to the minimum. Then gradually progress until you are able to work aerobically for 20-40 minutes. If you want to lose weight, you may want to do your aerobic workout five times a week.

It is important to exercise at an intensity vigorous enough to cause your heart rate and breathing to increase. How hard you should exercise depends to

a certain degree on your age, and is determined by measuring your heart rate in beats per minute. Refer to the "Measuring Your Heart Rate" section below and on page 16 for more information on how to determine and measure your heart rate.

You can do different types of aerobic activities, say walking one day, and use your New Balance 6.0u the next. Make sure you choose an activity that can be done regularly, and is enjoyable for you. The important thing to remember is not to skip too many days between workouts or fitness benefits will be lost. If you must lose a few days, gradually work back into your routine.

WHEN TO EXERCISE

The hour just before the evening meal is a popular time for exercise. The late afternoon workout provides a welcome change of pace at the end of the work day and helps dissolve the day's worries and tensions.

Another popular time to work out is early morning, before the work day begins. Advocates of the early start say it makes them more alert and energetic on the job.

Among the factors you should consider in developing your workout schedule are personal preference, job and family responsibilities, availability of exercise facilities and weather. It's important to schedule your workouts for a time when there is little chance that you will have to cancel or interrupt them because of other demands on your time.

You should not exercise strenuously during extremely hot, humid weather or within two hours after eating. Heat and/or digestion both make heavy demands on the circulatory system, and in combination with exercise can be an over-taxing double load.

MEASURING YOUR HEART RATE (see chart on page 17)

Heart rate is widely accepted as a good method for measuring intensity during running, swimming, cycling, and other aerobic activities. Exercise that doesn't raise your heart rate to a certain level and keep it there for 20 minutes won't contribute significantly to cardiovascular fitness.

The heart rate you should maintain is called your Target Heart Rate. There are several ways of arriving at this figure. One of the simplest is: maximum heart rate $(220 - \text{age}) \times 70\%$. Thus, the target heart rate for a 40 year-old would be 126. In this example for this

(continued on next page)

40 year old to get a cardiovascular effect the individual would need to keep their heart rate at or above 126 beats per minute to get a cardiovascular effect. **Note:** Although 70% was used in this example, the heart rate range needed to achieve results falls between 60% and 85% of your maximum heart rate.

If you are just beginning your exercise program, your target heart rate range should be roughly at 60% of your maximum heart rate. As you become more conditioned (or if you are already in good cardiovascular shape) you can increase your target heart rate to 70%-85% of your maximum heart rate. Remember, your target heart rate is only a guide.

When checking heart rate during a workout, take your pulse within five seconds after interrupting exercise because it starts to go down once you stop moving. Count pulse for 10 seconds and multiply by six to get the per-minute rate.

Remember, your New Balance 6.0u Upright Bike also comes with pulse sensors located on the handlebars.

When used properly, the unit pulse sensors can help you to determine your estimated heart rate. To do so:

- a) Push the start button on your computer.
- b) Gently grab **both** metal pulse sensors on **both** handlebars. Wait 6 seconds.
- c) Your estimated heart rate range will be displayed on screen. Check the chart on the following page to see if you are within your range according to your age.

When used properly, the heart rate pulse sensors and display monitor provide a reasonably accurate estimate of your actual heart rate. This estimate is not exact and persons with medical conditions and/or a specific need for accurate heart rate monitoring should not rely on the estimations provided.

By using the chart on page 17 you can see where your heart rate falls in the minimum and maximum target zones.

The above are guidelines, people with any medical limitations should discuss this formula with their physician.

CLOTHING

All exercise clothing should be loose-fitting to permit freedom of movement, and should make the wearer feel comfortable and self-assured.

Never wear rubberized or plastic clothing, such garments interfere with the evaporation of perspiration and can cause body temperature to rise to dangerous levels.

We recommend wearing a workout shoe with a rubberized sole unless instructed otherwise.

TIPS TO KEEP YOU GOING

- 1) Adopt a specific plan and write it down.
- 2) Keep setting realistic goals as you go along, and remind yourself of them often.
- 3) Keep a log to record your progress and make sure to keep it up-to-date. See pages 21-24.
- 4) Include weight and/or percent body fat measures in your log. Extra pounds can easily creep back.
- 5) Upgrade your fitness program as you progress. Your New Balance 6.0u provides 12 different workout programs to keep your workouts challenging.
- 6) Enlist the support and company of your family and friends.
- 7) Update others on your successes.
- 8) Avoid injuries by pacing yourself and including a warm up and cool down period as part of every workout. See page 15.
- 9) Reward yourself periodically for a job well done!

HEART RATE TARGET ZONE FOR CARDIOVASCULAR FITNESS

TABLE 1

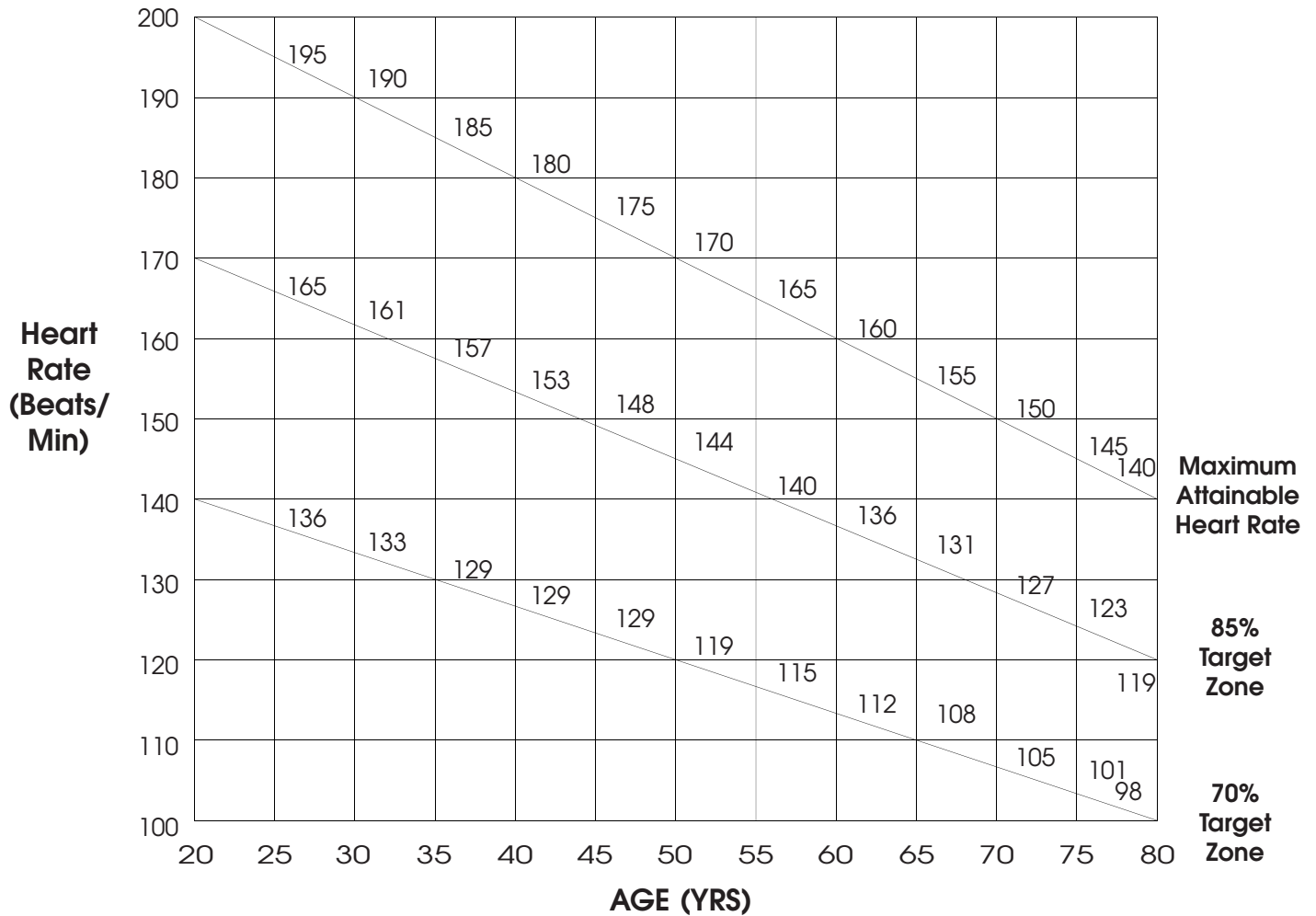
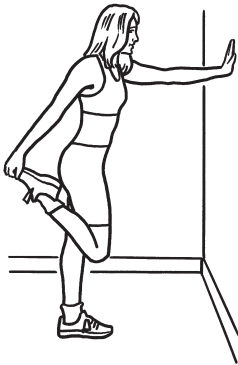

TABLE 2

Exercise Week	Warm Up Period	THR% Minutes	Cool Down Period	Total Time	Sessions Per Wk.	Total Time Per Wk.
1 & 2	5 min	60-65% -8	5 min	17 min	3	51 min
3 & 4	5 min	65-70% -10	5 min	20 min	3	60 min
5 & 6	5 min	70-75% -15	5 min	25 min	3	75 min
7 & 8	5 min	70-80% -20	5 min	30 min	3	90 min
9 & 10	5 min	70-85% -25	5 min	35 min	3	105 min
11 & 12	5 min	70-85% -25	5 min	35 min	3	105 min

WARM UP & COOL DOWN STRETCHES

Stretches can help improve flexibility and relieve the tightness in muscles that results from repetitive sport movements that require a limited range of motion. 10 to 12 minutes of daily stretching is recommended. This can be done when warming up or cooling down. When performing these stretches, your movements should be slow and smooth, with no bouncing or jerking. Move into the stretch until you feel a slight tension, not pain, in the muscle and hold the stretch for 20 to 30 seconds. Breathe slowly and rhythmically. Be sure not to hold your breath. Remember that all stretches must be done for both sides of your body.



1. Quadriceps Stretch

Stand close to a wall, chair or other solid object. Use one hand to assist your balance. Bend the opposite knee and lift your heel towards your buttocks. Reach back and grasp the top of your foot with the same side hand. Keeping your inner thighs close together, slowly pull your foot towards your buttocks until you feel a gentle stretch in the front of your thigh. You do not have to touch your buttocks with your heel. Stop pulling when you feel the stretch. Keep your kneecap pointing straight down and keep your knees close together. (Do not let the lifted knee swing outward.)

Hold the stretch for 20 to 30 seconds. Repeat for the other leg.

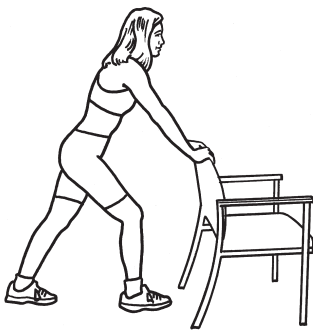

2. Calf and Achilles Stretch

Stand approximately one arms length away from a wall or chair with your feet hip-width apart. Keeping your toes pointed forward, move one leg in close to the chair while extending the other leg behind you. Bending the leg closest to the chair and keeping the other leg straight, place your hands on the chair. Keep the heel of the back leg on the ground and move your hips forward. Slowly lean forward from the ankle, keeping your back leg straight until you feel a stretch in your calf muscles.

Hold for 20 to 30 seconds. Repeat for the opposite leg.



3. Overhead/Triceps Stretch

Stand with your feet shoulder width apart and your knees slightly bent. Lift one arm overhead and bend your elbow, reaching down behind your head with your hand toward the opposite shoulder blade. Walk your fingertips down your back as far as you can. Hold this position. Reach up with your opposite hand and grasp your flexed elbow. Gently assist the stretch by pulling on the elbow.

Hold for 20 to 30 seconds. Repeat for the opposite arm.



4. Back Stretch

Stand with your legs shoulder length apart and your knees slightly bent. Bend forward from your waist with your arms extending loosely in front of your body. Gently bend from the waist flexing your body as far forward as it will go.

Hold for 20 to 30 seconds. Straighten up and repeat.



5. Standing Hamstrings Stretch

Stand with your legs hip-width apart. Extend one leg out in front of you and keep that foot flat against the ground. With your hands resting lightly on your thighs, bend your back leg and lean forward slightly from your hips until you feel a stretch in the back of your thigh. Be sure to lean forward from the hip joint rather than bending at your waist.

Hold for 20 to 30 seconds. Repeat for the opposite leg.



6. Buttocks, Hips and Abdominal Stretch

Lay flat on your back with your hips relaxed against the floor. Bend one leg at the knee. Keeping both shoulders flat on the floor, gently grasp the bent knee with your hands and pull it over your body and towards the ground. You should feel a stretch in your hips, abdominals and lower back.

Hold for 20 to 30 seconds and release. Repeat for opposite side.

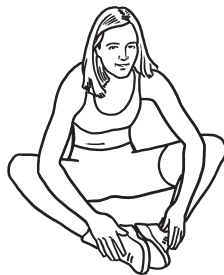

7. Inner Thigh Stretch

Sit on the floor and bend your legs so that the soles of your feet are together. Place your elbows on your knees. Lean forward from the waist and press down lightly on the inside of your knees. You should feel a stretch in the muscles of your inside thigh.



8. Arm Pullback

Stand with your feet shoulder width apart and toes pointing forward and with your knees slightly bent. Let your arms hang relaxed on either side of your body. Expand your chest and pull your shoulders back. Bend your elbows slightly and clasp your hands behind your back. Slowly straighten your arms as you lift your hands upward. Raise your hands upward until you feel mild tension in your shoulder and chest region.

Hold for 20 to 30 seconds. Lower your arms to their original position and bend your elbows. Release your hands and return them to your sides.

CARE & STORAGE OF YOUR NEW BALANCE 6.0u

Care Directions

Your New Balance 6.0u Upright Bike has been carefully designed to require minimum maintenance. However, we recommend the following to keep your unit operating smoothly.

- Unplug your unit when it is not in use.
- Use your unit indoors only.
- Wipe all perspiration from your bike with a soft, clean cloth after each use to prevent an accumulation of sweat and dirt.
- Clean your bike on a regular basis to prevent a build-up of dust. Use Windex or an alcohol based cleanser on a clean cloth. Do not use any abrasive cleaners and/or polish as these will damage the surface.
- Store your equipment in a dry area away from children and high traffic areas.
- Regularly check the tightness of nuts and bolts.

Storing Directions

Your bike is compact and portable. It can be easily moved from place to place.

- Unplug your unit.
- Stand in front of the bike and grasp the handlebars.
- Pull back, tipping the machine towards you until it is resting on the front transportation wheels/front rollers.
- Wheel the bike to its new location and store in an upright position.

WORKOUT PROGRESS CHARTS

Use the charts below and on the following pages to keep track of your progress over time. Before writing on them, make as many copies as you think you'll need. We suggest you keep these in a notebook. You will find it both informative and motivational to look back at what you've done, and this data will help you to chart future fitness goals as you progress. Every two weeks, measure yourself to rechart your progress.

Measuring Sites

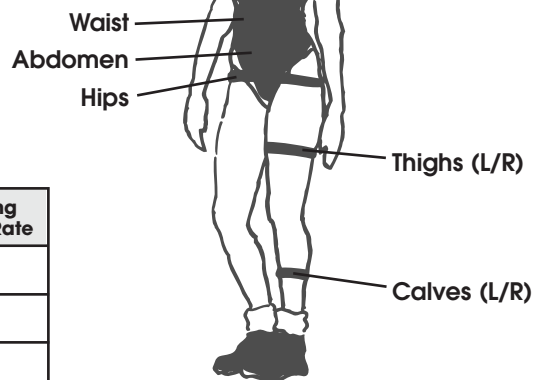

Date	Weight	Waist	Abdomen	Hips	Thighs	Calves	Resting Heart Rate

Date	Weight	Waist	Abdomen	Hips	Thighs	Calves	Resting Heart Rate

New Balance Fitness Equipment

Dedication to Quality

New Balance Fitness Equipment warrants this product to be free from all defects in material and workmanship when used according to the manufacturer's instructions. See Limited Warranty Card for details.

If you have any comments or questions contact our Customer Service Department, toll free at 1-800-292-5009, Monday through Friday, 9:00am to 5:00pm, EST.

Please record the following information and keep for reference.

Serial #: _____

Date Of Purchase: _____

Save your sales receipt.
(You may wish to staple it into this manual.)