

FitnessQuest[®]

Dedication to Quality

We warrant this product to be free from all defects in material and workmanship when used according to the manufacturer's instructions. See Limited Warranty Card for details.

Save your sales receipt.
(You may wish to staple it into this manual.)

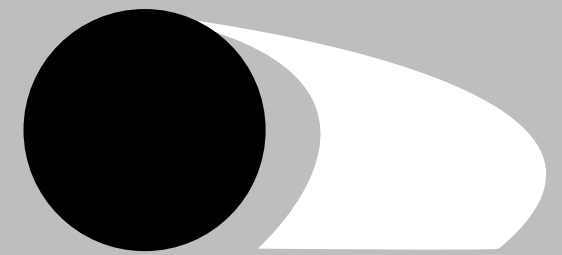

ECLIPSE[®]

1175e

Elliptical Trainer

OWNER'S MANUAL

FOR MAXIMUM EFFECTIVENESS AND SAFETY, PLEASE READ THIS OWNER'S MANUAL BEFORE USING YOUR ECLIPSE 1175e Elliptical Trainer.

WORKOUT PROGRESS CHARTS

Use the charts below to keep track of your progress over time. Before writing on them, make as many copies as you think you'll need. We suggest you keep these in a notebook. You will find it both informative and motivational to look back at what you've done, and this data will help you to chart future fitness goals as you progress. Every two weeks, measure yourself to rechart your progress.

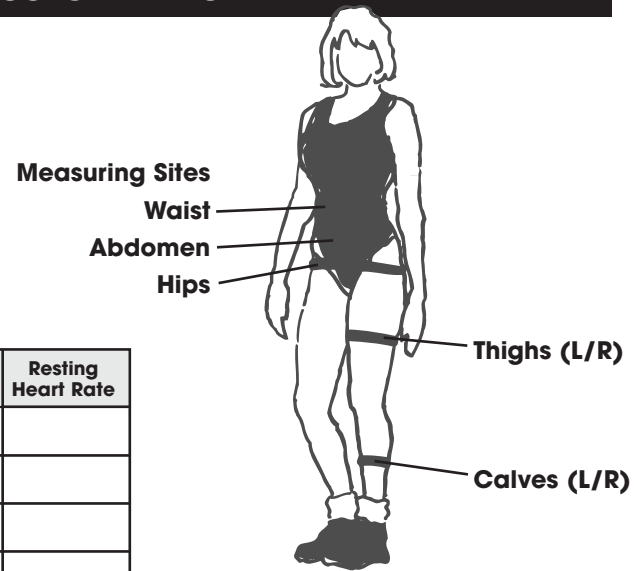

Date	Weight	Waist	Abdomen	Hips	Thighs	Calves	Resting Heart Rate

Date	Weight	Waist	Abdomen	Hips	Thighs	Calves	Resting Heart Rate

TABLE OF CONTENTS

Important Safety Instructions	2
Equipment Warning Labels	3
Specifications & Parts	3
Introduction	4
Hardware Kit	5
Assembly Instructions.....	6-10
Eclipse 1175e Parts List.....	10
Eclipse 1175e Exploded View	11
Getting Started	12
Using Your 1175e Elliptical Trainer.....	12
Changing Foot Positions.....	13
Using The Handlebars	13
Adjusting the Level of the Elliptical Trainer.....	13
Operating the Computer	14-16
Exercise Guidelines	17
Knowing the Basics.....	17
A Complete Exercise Program.....	17-18
Aerobic Exercise: How Much? How Often?	18
When to Exercise	18
Measuring Your Heart Rate	18-19
Clothing	19
Tips to Keep You Going.....	19
Heart Rate Target Zone Chart.....	20
Warm Up & Cool Down Stretches	21-22
Care & Storage of Your Elliptical Trainer.....	23
Workout Progress Charts	24

©2006 Fitness Quest Inc. All rights reserved. Made in China.
 Fitness Quest®, Eclipse® and OLS® are registered trademarks of Fitness Quest Inc.

8/8/06

IMPORTANT SAFETY INSTRUCTIONS

Read all instructions before using this equipment

CAUTION:

Exercise of a strenuous nature, as is customarily done on this equipment, should not be undertaken without first consulting a physician. No specific health claims are made or implied as they relate to the equipment.

- 1) Before starting this or any other exercise program, consult your physician, who can assist you in determining the target heart rate zone appropriate for your age and physical condition. Certain exercise programs or types of equipment may not be appropriate for all people. This is especially important for people over the age of 35, pregnant women, or those with pre-existing health problems or balance impairments.
- 2) Monitor your heart rate while you exercise and keep your estimated pulse rate within your target heart rate zone. Follow the instructions on pages 18 – 20 in this manual regarding heart rate monitoring and how to determine your appropriate target heart rate zone. When used properly, the heart rate pulse sensors and display monitor provide a reasonably accurate estimate of your actual heart rate. This estimate is not exact and persons with medical conditions and/or a specific need for accurate heart rate monitoring should not rely on the estimations provided.
- 3) Warm up before any exercise program by doing 5 - 10 minutes of aerobic activity, followed by stretching.
- 4) Wear comfortable clothes that allow freedom of movement and that are not tight or restricting.
- 5) Wear comfortable shoes made of good support with non-slip soles.
- 6) Breathe naturally, never holding your breath during an exercise.
- 7) Avoid over training. You should be able to carry on a conversation while exercising.
- 8) After an exercise session, cool down with slow walking and stretching.
- 9) This equipment should not be used by or near children.
- 10) Handicapped or disabled people must have medical approval before using this equipment and should be under close supervision when using any exercise equipment.
- 11) If you are taking medication which may affect your heart rate, a physician's advice is absolutely essential.
- 12) Use this equipment only for its intended use as described in this manual. Do not use attachments not recommended by the manufacturer.
- 13) Only one person at a time should use this equipment.
- 14) Do not put hands, feet, or any foreign objects on or near this equipment when in use by others.
- 15) Always use this equipment on a level surface.
- 16) Never operate the equipment if the equipment is not functioning properly.
- 17) Start exercise slowly and gradually increase the amount of resistance.
- 18) If the user experiences dizziness, nausea, chest pain, or any other abnormal symptoms, stop exercise at once and consult a physician immediately.
- 19) Use caution not to pinch fingers or hands in moving parts when using the equipment.
- 20) Risk of electrical shock. This equipment is to be used only indoors and in a dry location.

KEEP THESE INSTRUCTIONS

CARE & STORAGE OF YOUR ELLIPTICAL TRAINER

Care Directions

Your Elliptical Trainer has been carefully designed to require minimum maintenance. However, we recommend the following to keep your trainer operating smoothly.

- Unplug your elliptical trainer when it is not in use.
- Use your elliptical trainer indoors only.
- Wipe all perspiration from your elliptical trainer with a soft, clean cloth after each use to prevent an accumulation of sweat and dirt.
- Clean your elliptical trainer on a regular basis to prevent a build-up of dust. Use Windex or an alcohol based cleanser on a clean cloth. Do not use any abrasive cleaners and/or polish as these will damage the surface.
- Store your elliptical trainer in a dry area away from children and high traffic areas.
- Regularly check the tightness of nuts and bolts.

Storing Directions

Your elliptical trainer is lightweight, compact and portable. It can be easily moved from place to place.

- Unplug your elliptical trainer.
- Stand in front of the elliptical trainer and make sure that the dual-action handlebars are even. They are even when one foot platform is at the top of the elliptical disc and the other is at the bottom.
- Grasp the stationary handlebars and pull back, tipping the elliptical trainer towards you until it is resting on the transportation wheels/front rollers.
- Wheel the elliptical trainer to its new location and store in an upright position.

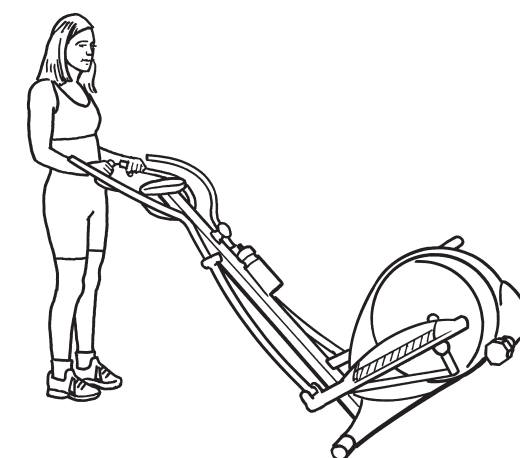
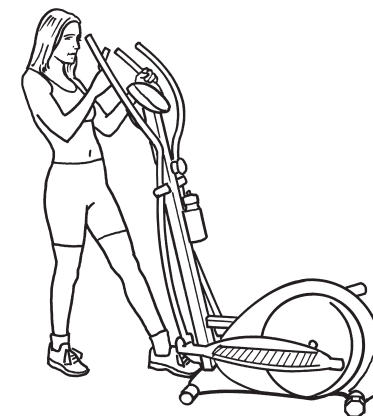

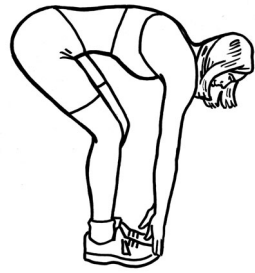

4. Back Stretch

Stand with your legs shoulder length apart and your knees slightly bent. Bend forward from your waist with your arms extending loosely in front of your body. Gently bend from the waist flexing your body as far forward as it will go.

Hold for 20 to 30 seconds. Straighten up and repeat.



5. Standing Hamstrings Stretch

Stand with your legs hip width apart. Extend one leg out in front of you and keep that foot flat against the ground. With your hands resting lightly on your thighs, bend your back leg and lean forward slightly from your hips until you feel a stretch in the back of your thigh. Be sure to lean forward from the hip joint rather than bending at your waist.

Hold for 20 to 30 seconds. Repeat for the opposite leg.

6. Buttocks, Hips and Abdominal Stretch



Lay flat on your back with your hips relaxed against the floor. Bend one leg at the knee. Keeping both shoulders flat on the floor, gently grasp the bent knee with your hands and pull it over your body and towards the ground. You should feel a stretch in your hips, abdominals and lower back.

Hold for 20 to 30 seconds and release. Repeat for opposite side.



7. Inner Thigh Stretch

Sit on the floor and bend your legs so that the soles of your feet are together. Place your elbows on your knees. Lean forward from the waist and press down lightly on the inside of your knees. You should feel a stretch in the muscles of your inside thigh.

Hold for 20 to 30 seconds and release.

8. Arm Pullback

Stand with your feet shoulder width apart and toes pointing forward and with your knees slightly bent. Let your arms hang relaxed on either side of your body. Expand your chest and pull your shoulders back. Bend your elbows slightly and clasp your hands behind your back. Slowly straighten your arms as you lift your hands upward. Raise your hands upward until you feel mild tension in your shoulder and chest region.

Hold for 20 to 30 seconds. Lower your arms to their original position and bend your elbows. Release your hands and return them to your sides.



EQUIPMENT WARNING LABELS

Important: See below for placement of the following warning labels on your equipment.

WARNING LABEL 1



FAILURE TO READ AND FOLLOW THE SAFETY INSTRUCTIONS STATED IN THE OWNER'S MANUAL MAY RESULT IN POSSIBLE SERIOUS INJURY OR DEATH. KEEP CHILDREN AWAY. MAXIMUM USER WEIGHT 275 LBS. REPLACE THIS LABEL IF DAMAGED, ILLEGIBLE OR REMOVED. CLASS HC.

WARNING LABEL 2



RISK OF ELECTRICAL SHOCK. THIS UNIT IS TO BE USED ONLY INDOORS AND IN A DRY LOCATION. DO NOT PLUG THE AC ADAPTER INTO WALL UNTIL ELECTRONICS MONITOR IS COMPLETELY ASSEMBLED.

WARNING LABEL 3 (2 locations)



CRUSH HAZARD. KEEP HANDS CLEAR DURING OPERATION.

SPECIFICATIONS & PARTS

Eclipse 1175e Specifications:

Approximate:

Length: 46.25"

Width: 26.5"

Height: 65"

Product Weight:

Approx. 119 lbs.

Maximum User Weight:

275 lbs.

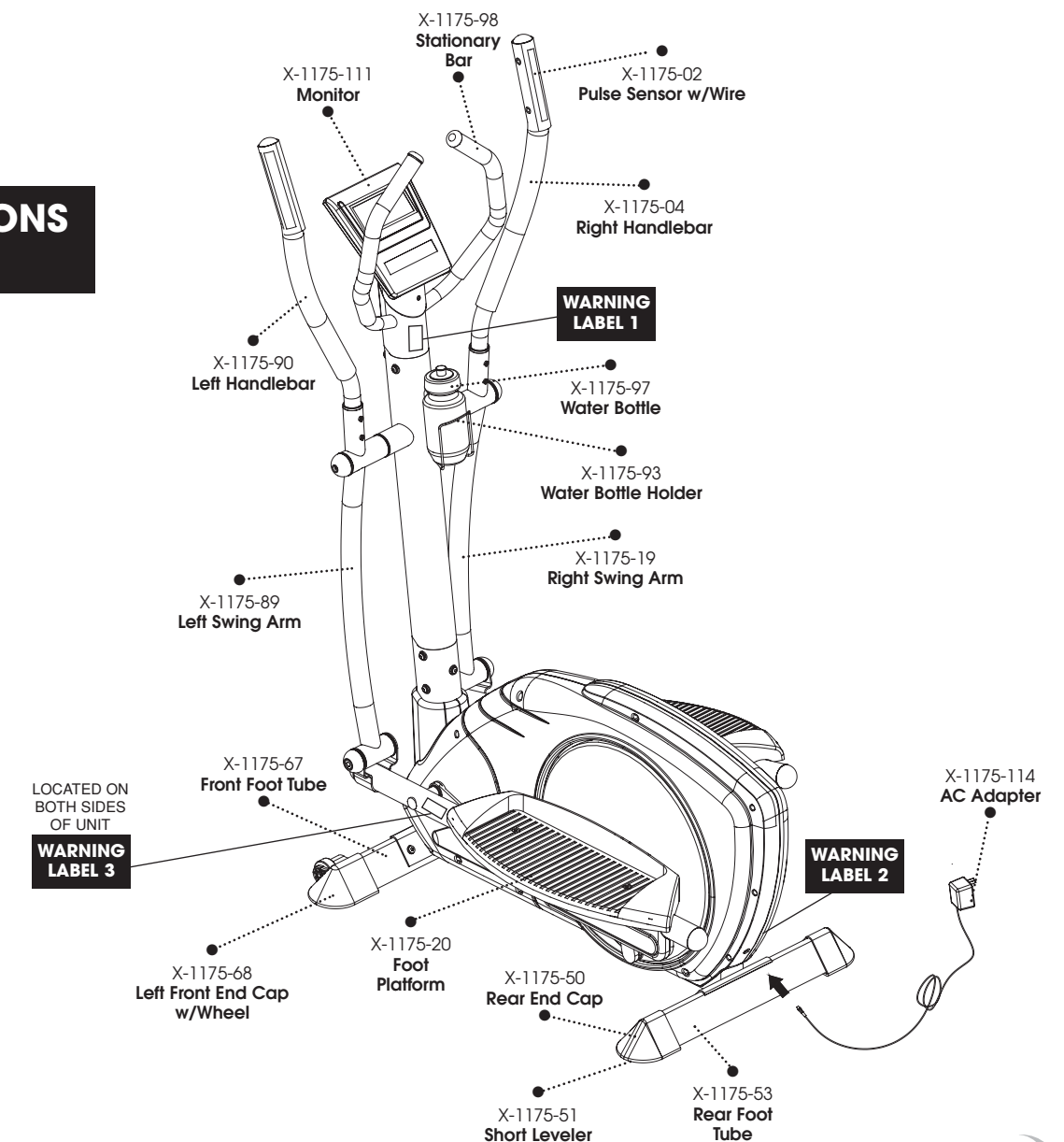

INTRODUCTION

CONGRATULATIONS ON PURCHASING YOUR ECLIPSE 1175e ELLIPTICAL TRAINER

With this product in your home, you have everything you need to start your own workout program to tone and firm the major muscle groups of your lower body. This is vital for all of us, regardless of age, sex, or fitness level, and regardless of whether your primary goal is toning, health maintenance, or more energy for daily activities.

Proper exercise, including a low fat diet, strength training and aerobic exercise, tones and conditions the muscles we use every day to stand, walk, lift and turn. It can actually transform our body composition by reducing body fat and increasing the proportion of lean muscle in our bodies. Using the Elliptical Trainer will help in reducing body fat and increasing cardiovascular endurance.

Be sure to read through this Owner's Manual carefully.

It is the authoritative source of information about your Elliptical Trainer.

Retain this manual for future reference.

COMMENTS OR QUESTIONS

Dear Customer,

Congratulations on your purchase of your Elliptical Trainer.

We're sure that you will be completely satisfied with the product and we invite your comments so that we can hear about your success.

Please write or call our Customer Service Specialists at the address or phone number listed below, or contact us on our web site or email us with any comments or questions you may have.

**Eclipse 1175e Elliptical Trainer
Customer Service Department
1400 Raff Road SW, Canton OH 44750-0001**

1-800-321-9236, Monday through Friday
8:30am to 8:00pm, Eastern Standard Time

**Please do not call the above number for Parts.
See Ordering Replacement Parts section to the right.**

email: customersupport@fitnessquest.com
www.fitnessquest.com

All details depicted in this Owner's Manual, and of the product itself, are subject to change without notice.

ORDERING REPLACEMENT PARTS

When ordering parts, please contact our Parts Department, toll free at 1-800-497-5831, Monday through Friday, 8:30am to 8:00pm, EST.

IMPORTANT: You must have your serial number and this manual ready when calling for parts.

Serial #: _____

Please also provide the following information:

- 1) Name, Mailing Address and Telephone Number
- 2) Date of Purchase
- 3) Where Product was Purchased (Name of Retail Store, City)
- 4) Model Number (EEL1175)
- 5) Part Order Number and Description

WARM UP & COOL DOWN STRETCHES

Stretches can help improve flexibility and relieve the tightness in muscles that results from repetitive sport movements that require a limited range of motion, like elliptical striding. 10 to 12 minutes of daily stretching is recommended. This can be done when warming up or cooling down. When performing these stretches, your movements should be slow and smooth, with no bouncing or jerking. Move into the stretch until you feel a slight tension, not pain, in the muscle and hold the stretch for 20 to 30 seconds. Breathe slowly and rhythmically. Be sure not to hold your breath. Remember that all stretches must be done for both sides of your body.

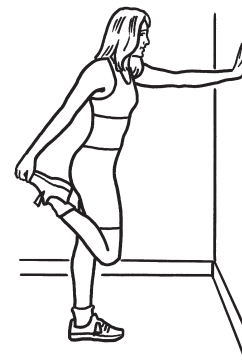

1. Quadriceps Stretch

Stand close to a wall, chair or other solid object. Use one hand to assist your balance. Bend the opposite knee and lift your heel towards your buttocks. Reach back and grasp the top of your foot with the same side hand. Keeping your inner thighs close together, slowly pull your foot towards your buttocks until you feel a gentle stretch in the front of your thigh. You do not have to touch your buttocks with your heel. Stop pulling when you feel the stretch. Keep your kneecap pointing straight down and keep your knees close together. (Do not let the lifted knee swing outward.)

Hold the stretch for 20 to 30 seconds. Repeat for the other leg.

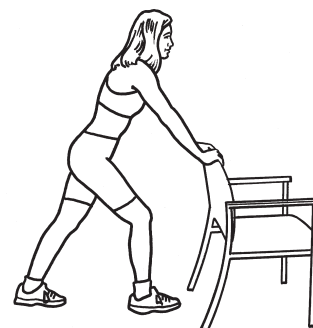

2. Calf and Achilles Stretch

Stand approximately one arms length away from a wall or chair with your feet hip-width apart. Keeping your toes pointed forward, move one leg in close to the chair while extending the other leg behind you. Bending the leg closest to the chair and keeping the other leg straight, place your hands on the chair. Keep the heel of the back leg on the ground and move your hips forward. Slowly lean forward from the ankle, keeping your back leg straight until you feel a stretch in your calf muscles.

Hold for 20 to 30 seconds. Repeat for the opposite leg.



3. Overhead/Triceps Stretch

Stand with your feet shoulder width apart and your knees slightly bent. Lift one arm overhead and bend your elbow, reaching down behind your head with your hand toward the opposite shoulder blade. Walk your fingertips down your back as far as you can. Hold this position. Reach up with your opposite hand and grasp your flexed elbow. Gently assist the stretch by pulling on the elbow.

Hold for 20 to 30 seconds. Repeat for the opposite arm.

(continued on next page)

HEART RATE TARGET ZONE FOR CARDIOVASCULAR FITNESS

TABLE 1

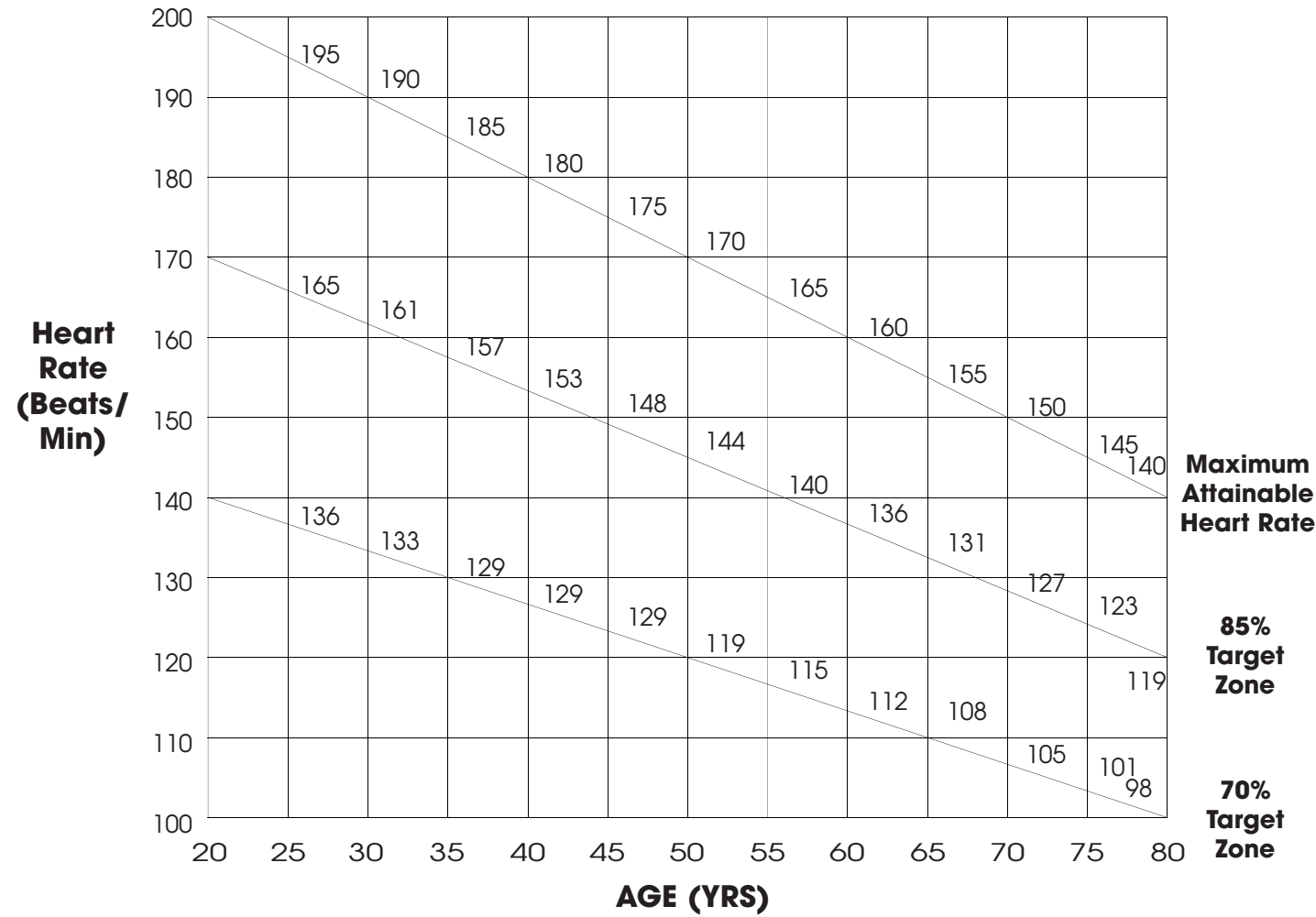
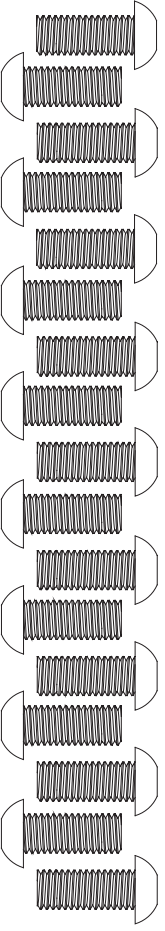
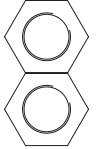
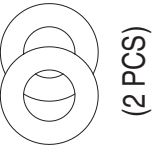
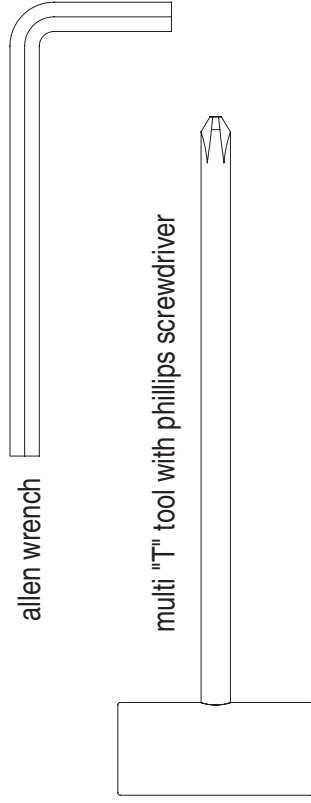
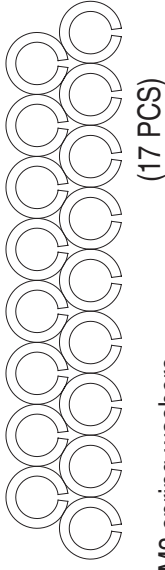
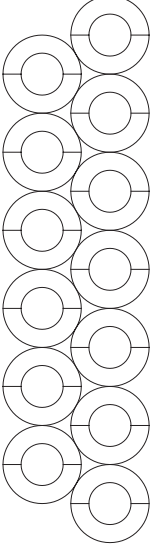

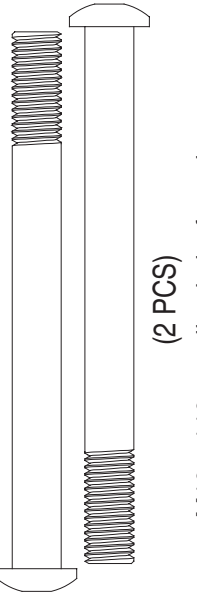
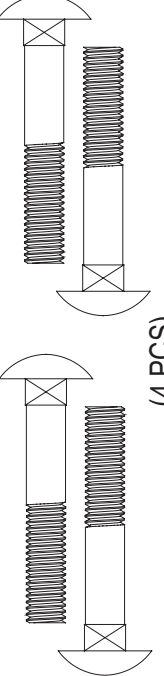

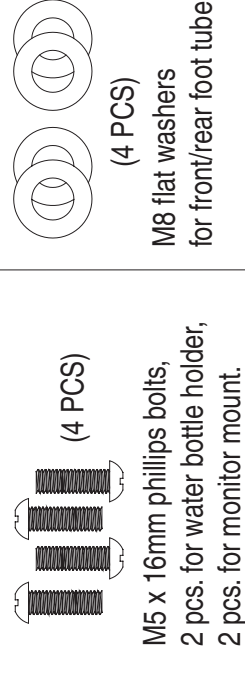

TABLE 2

Exercise Week	Warm Up Period	THR% Minutes	Cool Down Period	Total Time	Sessions Per Wk.	Total Time Per Wk.
1 & 2	5 min	60-65% -8	5 min	17 min	3	51 min
3 & 4	5 min	65-70% -10	5 min	20 min	3	60 min
5 & 6	5 min	70-75% -15	5 min	25 min	3	75 min
7 & 8	5 min	70-80% -20	5 min	30 min	3	90 min
9 & 10	5 min	70-85% -25	5 min	35 min	3	105 min
11 & 12	5 min	70-85% -25	5 min	35 min	3	105 min

HARDWARE KIT

 <p>(17 PCS) M8 x 20mm allen bolts, 4 pcs. for front/rear foot tube, 6 pcs. for vertical tube, 3 pcs. for stationary bar, 4 pcs. for foot platform.</p>	 <p>(2 PCS) M10 nylon nuts for swing arm.</p>	 <p>(2 PCS) M10 flat washers for swing arm.</p>	 <p>allen wrench multi "T" tool with phillips screwdriver</p>
 <p>(17 PCS) M8 spring washers, 4 pcs. for front/rear foot tube, 6 pcs. for vertical tube, 3 pcs. for stationary bar, 4 pcs. for handlebar.</p>	 <p>(13 PCS) M8 curved washers, 6 pcs. for vertical tube, 3 pcs. for stationary bar, 4 pcs. for handlebar.</p>	 <p>(2 PCS) Bottom spacers for swing arm.</p>	
 <p>(2 PCS) M10 x 110mm allen bolts for swing arm.</p>	 <p>(4 PCS) M8 x 50mm carriage bolts for handlebar.</p>	 <p>(4 PCS) M8 acorn nuts for handlebar.</p>	 <p>(4 PCS) M8 flat washers for front/rear foot tube. (4 PCS) M5 x 16mm phillips bolts, 2 pcs. for water bottle holder, 2 pcs. for monitor mount.</p>

ASSEMBLY INSTRUCTIONS

Occasionally our products contain components that are pre-lubricated at the factory. We recommend that you protect flooring, or anything else the parts may contact, with newspaper or cloth.

Tools Required (included):

Allen Wrench
Multi "T" Tool w/Phillips Screwdriver

NOTE: All location references, such as front, rear, left or right, made in these instructions are from the user being on the equipment and facing forward.

STEP 1 - Attaching the Foot Tubes

- Attach the Front Foot Tube to the Main Frame using two Allen Bolts with a Flat Washer and a Spring Washer on each Bolt.
- Attach the Rear Foot Tube to the Main Frame using two Allen Bolts with a Flat Washer and a Spring Washer on each Bolt.

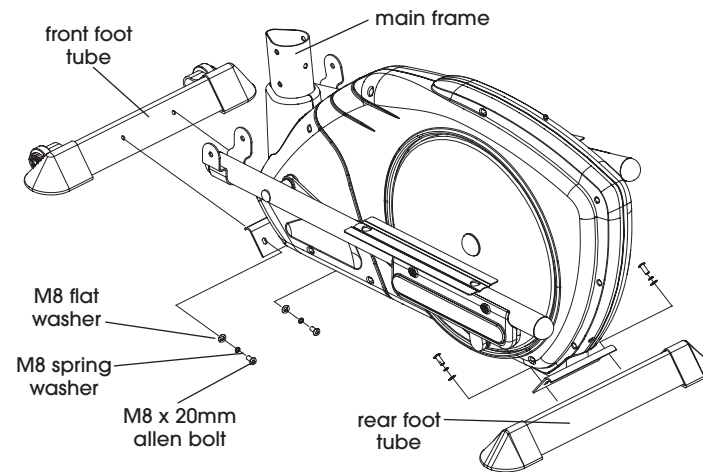

Figure 1 - Install Foot Tubes

STEP 2 - Attaching the Monitor Tube

- Securely connect the Main Frame Wire to the Vertical Tube Wire.
- Carefully insert the Vertical Tube into the front tube in Main Frame. Please make sure that the bolt holes line up between the Vertical Tube and the front tube in the Main Frame.
- Fasten six Allen Bolts with a Spring Washer and a Curved Washer through the Vertical Tube into the front tube on the Main Frame.

Note:

Do not pinch the wires.

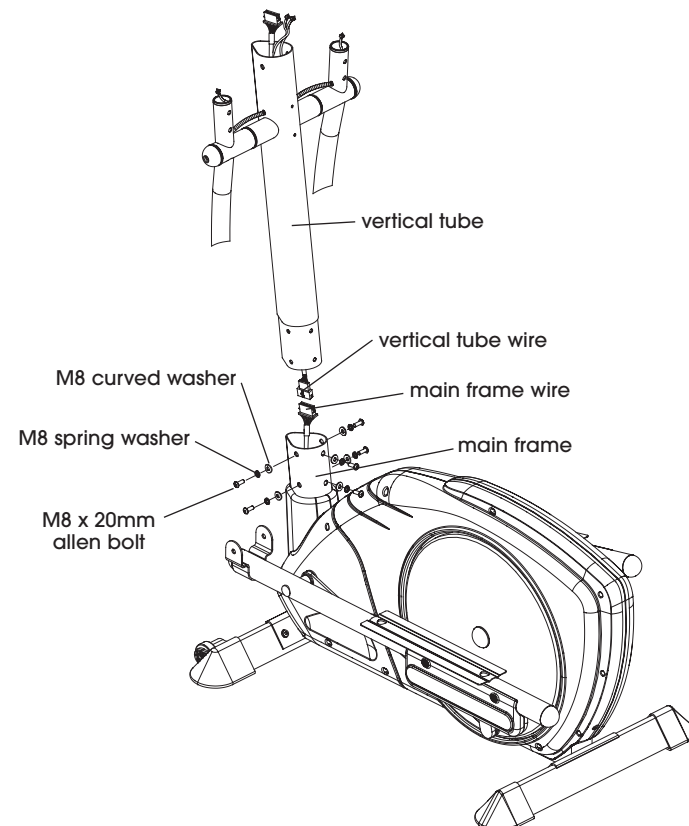

Figure 2 - Install Monitor Tube

40 year old to get a cardiovascular effect the individual would need to keep their heart rate at or above 126 beats per minute to get a cardiovascular effect. **Note:** Although 70% was used in this example, the heart rate range needed to achieve results falls between 60% and 85% of your maximum heart rate.

If you are just beginning your exercise program, your target heart rate range should be roughly at 60% of your maximum heart rate. As you become more conditioned (or if you are already in good cardiovascular shape) you can increase your target heart rate to 70%-85% of your maximum heart rate. Remember, your target heart rate is only a guide.

When checking heart rate during a workout, take your pulse within five seconds after interrupting exercise because it starts to go down once you stop moving. Count pulse for 10 seconds and multiply by six to get the per-minute rate.

Remember, your elliptical trainer also comes with pulse sensors located on the dual-action handlebars.

When used properly, the unit pulse sensors can help you to determine your estimated heart rate. To do so:

- Push the START button on your monitor.
- Gently grab **both** metal pulse sensors on **both** handlebars. Wait 6 seconds.
- Your estimated heart rate range will be displayed on screen. Check the chart on the following page to see if you are within your range according to your age.

When used properly, the heart rate pulse sensors and display monitor provide a reasonably accurate estimate of your actual heart rate. This estimate is not exact and persons with medical conditions and/or a specific need for accurate heart rate monitoring should not rely on the estimations provided.

By using the chart on the following page, you can see where your heart rate falls in the minimum and maximum target zones.

The above are guidelines, people with any medical limitations should discuss this formula with their physician.

CLOTHING

All exercise clothing should be loose-fitting to permit freedom of movement, and should make the wearer feel comfortable and self-assured.

Never wear rubberized or plastic clothing, such as garments interfere with the evaporation of perspiration and can cause body temperature to rise to dangerous levels.

We recommend wearing a workout shoe with a rubberized sole unless instructed otherwise.

TIPS TO KEEP YOU GOING

- Adopt a specific plan and write it down.
- Keep setting realistic goals as you go along, and remind yourself of them often.
- Keep a log to record your progress and make sure to keep it up-to-date. See page 24.
- Include weight and/or percent body fat measures in your log. Extra pounds can easily creep back.
- Upgrade your fitness program as you progress. Your elliptical trainer provides 12 different programs to keep your workouts challenging.
- Enlist the support and company of your family and friends.
- Update others on your successes.
- Avoid injuries by pacing yourself and including a warm up and cool down period as part of every workout. See page 18.
- Reward yourself periodically for a job well done!

Your exercise program should include something from each of the four basic fitness components described previously. Each workout should begin with a warm up and end with a cool down. As a general rule, space your workouts throughout the week and avoid consecutive days of hard exercise.

Here are the amounts of activity necessary for the average healthy person to maintain a minimum level of overall fitness. Included are some of the popular exercises for each category.

WARM UP - 5-10 minutes of exercise such as walking, slow jogging, knee lifts, arm circles or trunk rotations. Low intensity movements that simulate movements to be used in the activity can also be included in the warm up.

MUSCULAR STRENGTH - a minimum of two, 20 minute sessions per week that include exercises for all the major muscle groups. Lifting weights is the most effective way to increase strength.

MUSCULAR ENDURANCE - at least three, 30 minute sessions each week that include exercises such as calisthenics, push ups, sit ups, pull ups, and weight training for all the major muscle groups.

CARDIORESPIRATORY ENDURANCE - at least three, 20 minute workouts of continuous aerobic exercise each week. Working out on your elliptical trainer is a good way to obtain this aerobic activity. Other popular aerobic conditioning activities include brisk walking, jogging, swimming, cycling, rope jumping, rowing, cross-country skiing, and some continuous action games like racquetball and handball.

FLEXIBILITY - 10-12 minutes of daily stretching exercises performed slowly, without a bouncing motion. This can be included after a warm up or during a cool down. Refer to pages 21 and 22 for a list of total body stretches.

COOL DOWN - a minimum of 5-10 minutes of slow walking or lower intensity elliptical exercise, combined with stretching.

AEROBIC EXERCISE: HOW MUCH? HOW OFTEN?

Experts recommend that you do some form of aerobic exercise at least three times a week for a minimum of 20 continuous minutes. Of course, if that is too much, start with a shorter time span and gradually build up to the minimum. Then gradually progress until you are able to work aerobically for 20-40 minutes. If you want to lose weight, you may want to do your aerobic workout five times a week.

It is important to exercise at an intensity vigorous enough to cause your heart rate and breathing to increase. How hard you should exercise depends to a certain degree on your age, and is determined by measuring your heart rate in beats per minute. Refer to the "Measuring Your Heart Rate" section below and on page 19 for more information on how to determine and measure your heart rate.

You can do different types of aerobic activities, say walking one day, and use your elliptical trainer the next. Make sure you choose an activity that can be done regularly, and is enjoyable for you. The important thing to remember is not to skip too many days between workouts or fitness benefits will be lost. If you must lose a few days, gradually work back into your routine.

WHEN TO EXERCISE

The hour just before the evening meal is a popular time for exercise. The late afternoon workout provides a welcome change of pace at the end of the work day and helps dissolve the day's worries and tensions.

Another popular time to work out is early morning, before the work day begins. Advocates of the early start say it makes them more alert and energetic on the job.

Among the factors you should consider in developing your workout schedule are personal preference, job and family responsibilities, availability of exercise facilities and weather. It's important to schedule your workouts for a time when there is little chance that you will have to cancel or interrupt them because of other demands on your time.

You should not exercise strenuously during extremely hot, humid weather or within two hours after eating. Heat and/or digestion both make heavy demands on the circulatory system, and in combination with exercise can be an over-taxing double load.

MEASURING YOUR HEART RATE (see chart on page 20)

Heart rate is widely accepted as a good method for measuring intensity during running, swimming, cycling, and other aerobic activities. Exercise that doesn't raise your heart rate to a certain level and keep it there for 20 minutes won't contribute significantly to cardiovascular fitness.

The heart rate you should maintain is called your Target Heart Rate. There are several ways of arriving at this figure. One of the simplest is: maximum heart rate $(220 - \text{age}) \times 70\%$. Thus, the target heart rate for a 40 year-old would be 126. In this example for this

STEP 3 - Attaching the Swing Arms

- The bottom of the Left Swing Arm will have a hole that will line up with the holes in the bracket of the Left Foot Tube.

From the inside, slide the Allen Bolt through the holes in the Left Foot Tube Bracket and the hole in the Left Swing Arm. This secures the Left Swing Arm to the Left Foot Tube.

- Insert a Bottom Spacer and Flat Washer, followed by a Nylon Nut onto the Allen Bolt, and then tighten.
- Repeat steps **a** and **b** to attach the Right Swing Arm.

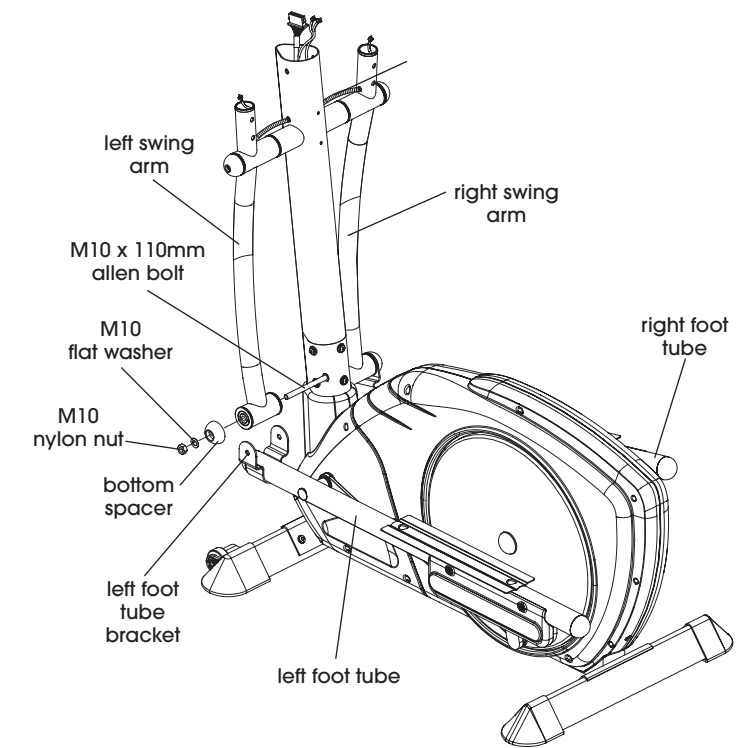

Figure 3 - Install Swing Arms

STEP 4 - Attaching the Foot Platforms

- Place a Foot Platform on the Left Foot Tube.
- Align the two holes between the Foot Platform and the Left Foot Tube. Insert two Allen Bolts and tighten the Bolts.
- Repeat steps **a** and **b** to attach the other Foot Platform to the right side.

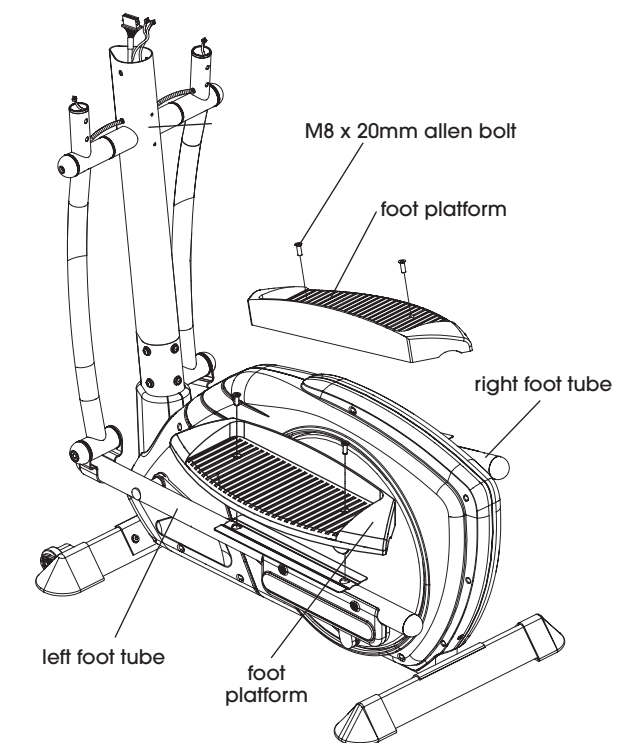

Figure 4 - Install Foot Platforms

STEP 5 - Attaching the Stationary Bar

- Insert the Stationary Bar into the Vertical Tube. Please make sure the Wires are protruding out of the top, and align the holes in the bottom of the Stationary Bar with the holes in the top of the Vertical Tube.
- Insert the three Allen Bolts with a Curved Washer and Spring Washer per Allen Bolt. Tighten all Allen Bolts.

Note: Do not pinch the wires.

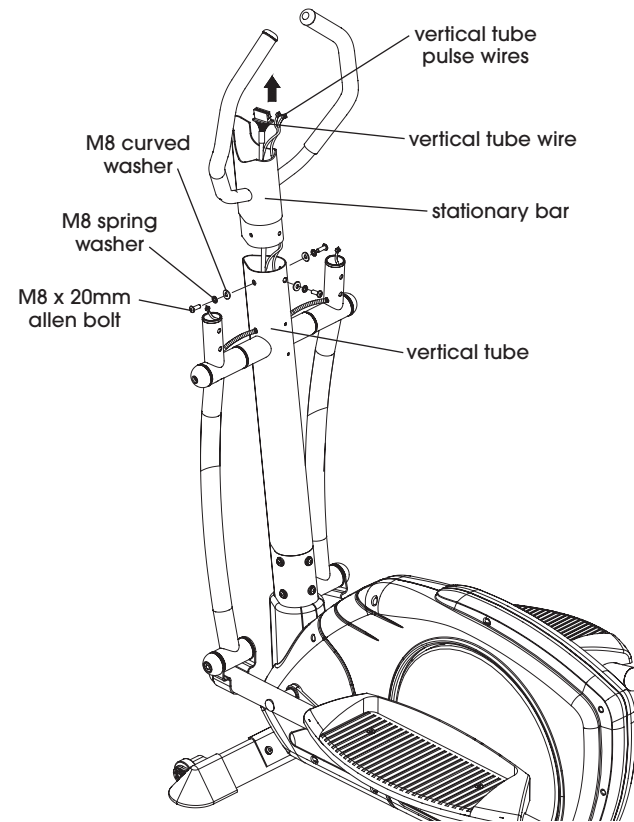

Figure 5 - Install Stationary Bar

STEP 6 - Attaching the Water Bottle Holder

- Align the two holes of the Vertical Tube with the two holes in the Water Bottle Holder. Secure the Holder with two Phillips Bolts.
- Insert Water Bottle into the Holder. Be sure to wash the bottle before usage.

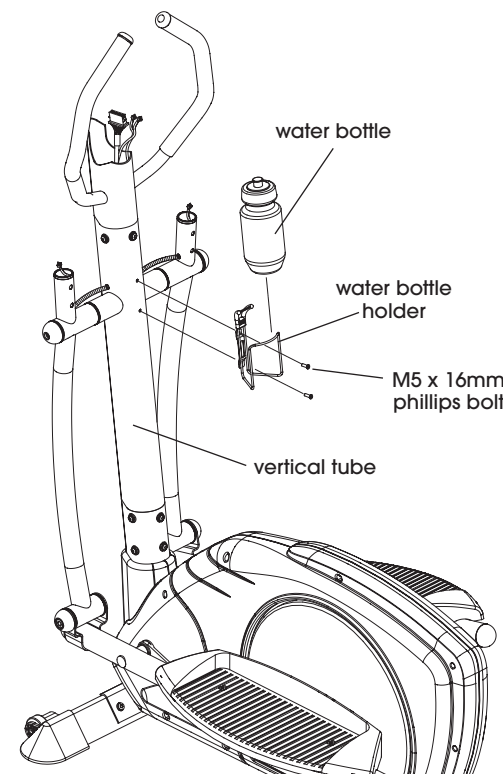

Figure 6 - Install Water Bottle Holder

IMPORTANT

Please review this section before you begin exercising.

IMPORTANT:

If you are over 35 and have been inactive for several years, you should consult your physician, who may or may not recommend a graded exercise test.

If you are just beginning your exercise program, your target heart rate range should be roughly at 60% of your maximum heart rate. As you become more conditioned (or if you are already in good cardiovascular shape) you can increase your target heart rate to 70%-85% of your maximum heart rate. Remember, your target heart rate is only a guide.

You should also consult your physician if you have the following:

- High blood pressure
- High cholesterol
- Asthma
- Heart trouble
- Family history of early stroke or heart attack deaths
- Frequent dizzy spells
- Extreme breathlessness after mild exertion
- Arthritis or other bone problems
- Severe muscular, ligament or tendon problems
- Other known or suspected disease
- If you experience any pain or tightness in your chest, an irregular heartbeat or shortness of breath, stop exercising immediately. Consult your physician before continuing.
- Pregnant
- Balance Impairment
- Taking medications that affect heart rate

KNOWING THE BASICS

Physical fitness is most easily understood by examining its components, or "parts".

There is widespread agreement that these five components comprise the basics of physical training:

CARDIORESPIRATORY ENDURANCE - the ability to deliver oxygen and nutrients to tissues, and to remove wastes, over sustained periods of time. Using your elliptical trainer will improve this.

MUSCULAR STRENGTH - the ability of a muscle to exert force for a brief period of time. Upper-body strength, for example, can be measured by various weight-lifting exercises.

MUSCULAR ENDURANCE - the ability of a muscle, or a group of muscles, to sustain repeated contractions or to continue applying force against a fixed object. Push-ups are often used to test endurance of arm and shoulder muscles.

FLEXIBILITY - the ability to move joints and use muscles through their full range of motion. The sit-and-reach test is a good measure of flexibility of the lower back and backs of the upper legs.

BODY COMPOSITION - often considered a component of fitness. It refers to the makeup of the body in terms of lean mass (muscle, bone, vital tissue and organs) and fat mass. An optimal ratio of fat to lean mass is an indication of fitness, and the right types of exercises will help you decrease body fat and increase or maintain muscle mass. To help track your progress we have provided a Workout Progress Chart on page 24.

A COMPLETE EXERCISE PROGRAM

How often, how long and how hard you exercise, and what kinds of exercises you do should be determined by what you are trying to accomplish. Your goals, your present fitness level, age, health, skills, interest and convenience are among the factors you should consider. For example, an athlete training for high-level competition would follow a different program than a person whose goals are good health and the ability to meet work and recreational needs.

(continued on next page)

Program Profiles

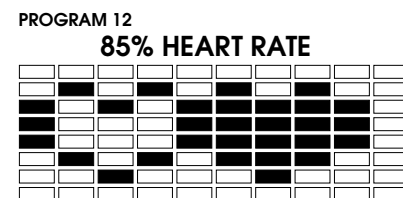
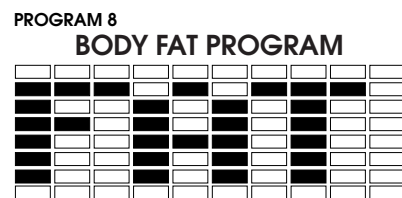
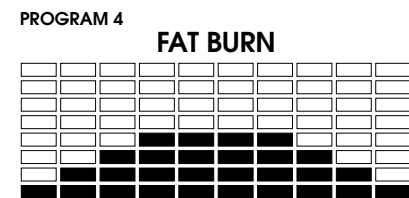
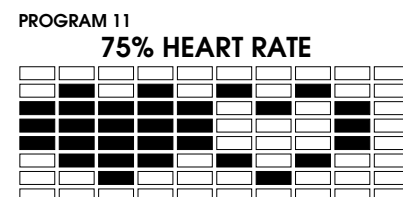
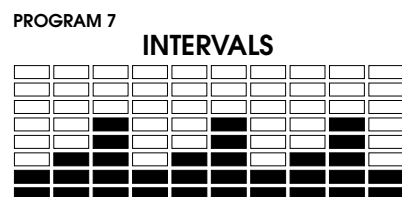
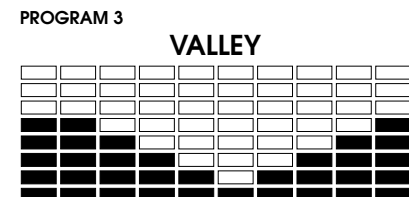
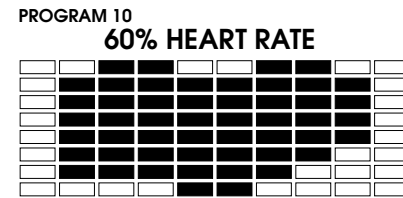
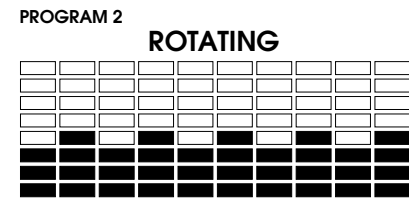
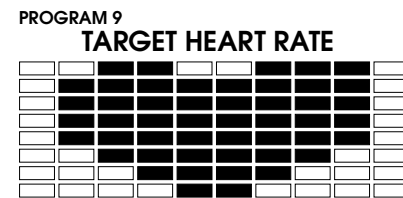
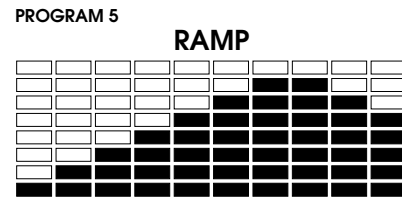
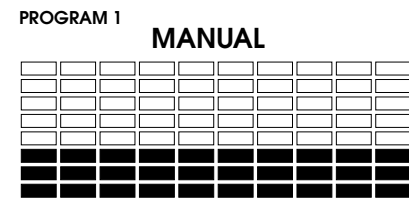

STEP 7 - Attaching the Monitor

- Remove the Bolts from the rear of the Monitor (see 7a).
- Put the Wires from the rear of the Monitor into the large hole of the Monitor Plate. Then insert the Bolts through the Monitor Plate into the Monitor.
- Connect the Monitor Wire to the Vertical Tube Wire.
- Connect the Monitor Pulse Wires to the Vertical Tube Pulse Wires.
- Insert the Monitor Plate into the Vertical Tube. Align the Bolt holes after inserting Monitor Mount (see 7b).
- Insert and tighten two Phillips Bolts into the holes.

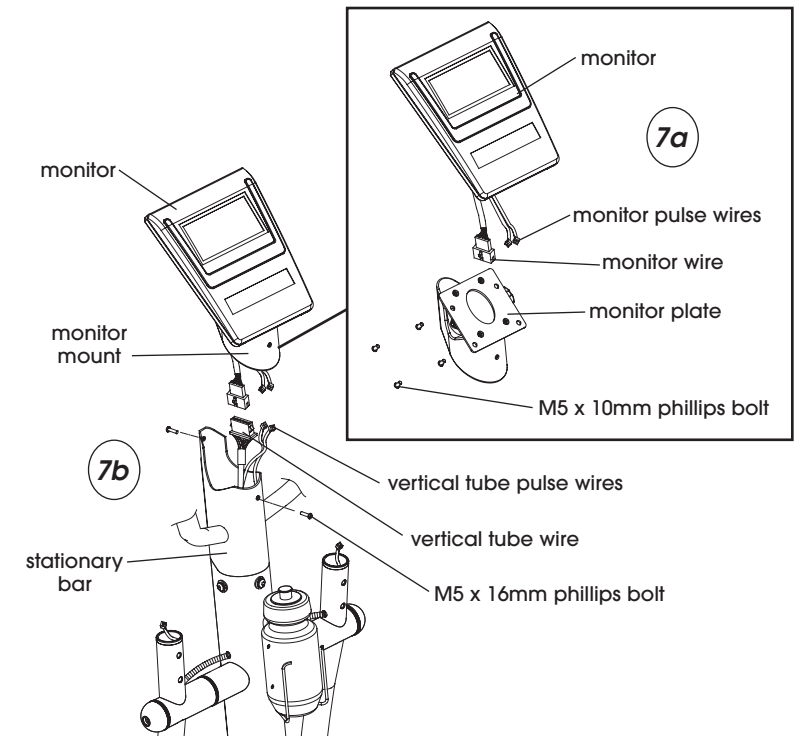

Figure 7a & b - Install Monitor

STEP 8 - Installing the Handlebars

- Connect the Vertical Tube Pulse Wire to the Left Handlebar Pulse Sensor Wire.
- Install the Left Handlebar into the Left Swing Arm. Make sure to align the Bolt Holes of the Left Handlebar with the Bolt Holes of the Left Swing Arm.
- From the rear of the Elliptical, insert the two Carriage Bolts through the two holes.
- Install a Curved Washer, a Spring Washer, and then an Acorn Nut onto each Bolt. Make sure each Acorn Nut is tightened.
- Connect the Vertical Tube Pulse Wire with the Right Handlebar Pulse Sensor Wire.
- Install the Right Handlebar into the Right Swing Arm. Make sure to align the Bolt Holes of the Right Handlebar with the Bolt Holes of the Right Swing Arm.
- From the rear of the Elliptical, insert the two Carriage Bolts through the two holes.
- Install a Curved Washer, a Spring Washer, and then an Acorn Nut onto each Bolt. Make sure each Acorn Nut is tightened.

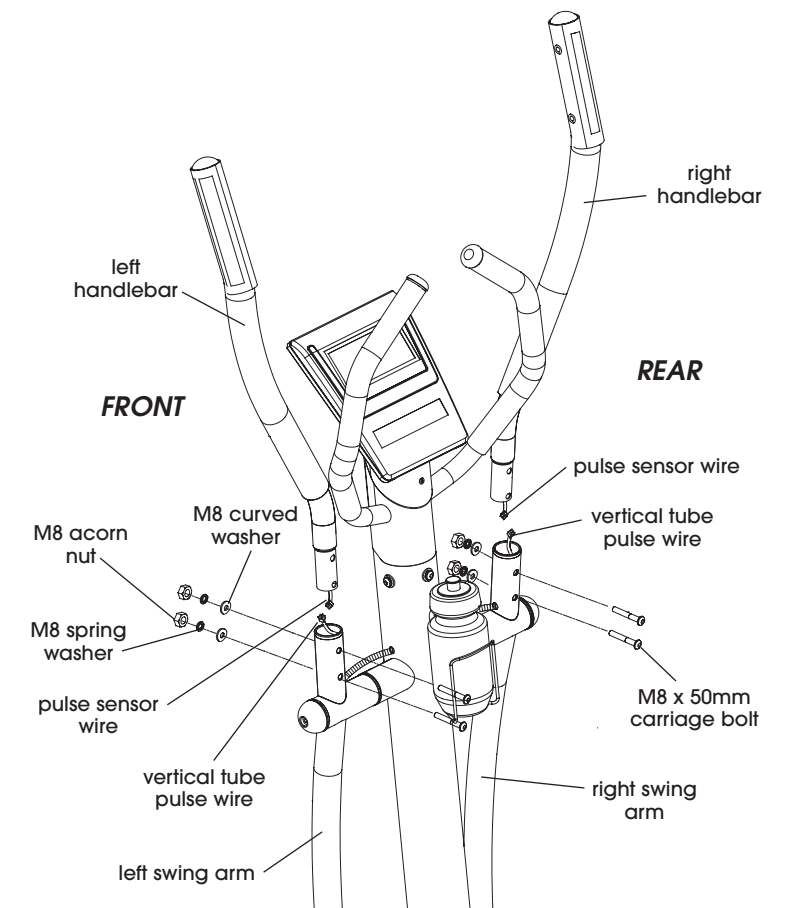

Figure 8 - Install Handlebars

Step 9 - Plugging in the AC Adapter

- a) Attach the AC Adapter to the Input located on the rear of the elliptical trainer. Then, plug the AC Adapter into a 110 Volt outlet.

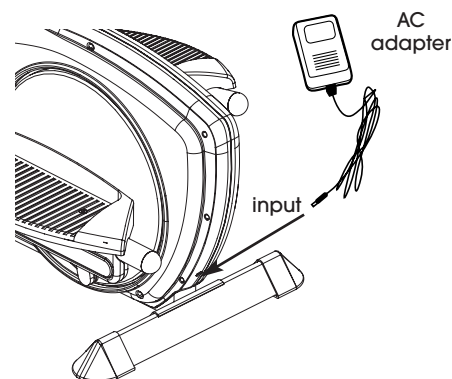

Figure 9 - AC Adapter

Assembly is now complete.

IMPORTANT:
Please read pages 12-13 before beginning your workout for important instructions on how to use your elliptical trainer.

ECLIPSE 1175e PARTS LIST

PART #	ITEM #	DESCRIPTION	QTY.	PART #	ITEM #	DESCRIPTION	QTY.
X1175-01	1	large end cap	2	X1175-53	54	rear foot tube	1
X1175-02	2	pulse sensor w/wire	2	X1175-54	55	main frame	1
X1175-03	3	M3 x 20mm phillips screw	4	X1175-55	56	AC adapter plug	1
X1175-04	4	right handlebar	1	X1175-56	57	sensor w/wire	1
X1175-06	6	M8 x 30mm allen bolt	2	X1175-62	63	main frame wire	1
X1175-07	7	M8 flat washer	6	X1175-63	64	vertical tube wire	1
X1175-08	8	top spacer	2	X1175-64	65	right front end cap w/wheel	2
X1175-09	9	M8 large washer	2	X1175-67	68	front foot tube	1
X1175-11	11	plastic bushing	8	X1175-68	69	left front end cap w/wheel	2
X1175-12	12	swing arm sleeve	2	X1175-76	75	M5 x 16mm phillips bolt	4
X1175-13	13	M8 curved washer	13	X1175-85	86	left shroud	1
X1175-14	14	M8 spring washer	19	X1175-86	87	left cover	1
X1175-15	15	M8 acorn nut	4	X1175-88	89	left foot tube	1
X1175-16	16	M8 x 50mm carriage bolt	4	X1175-89	90	left swing arm	1
X1175-17	17	small wavy washer	2	X1175-90	91	left handlebar	1
X1175-18	18	top plastic spacer	2	X1175-91	92	vertical tube	1
X1175-19	19	right swing arm	1	X1175-92	93	water bottle holder w/clip	1
X1175-20	21	foot platform	2	X1175-93	94	wire plug	4
X1175-21	22	M10 nylon nut	2	X1175-94	95	wire sleeve	2
X1175-22	23	M10 flat washer	2	X1175-95	96	vertical tube pulse wire	2
X1175-23	24	bottom spacer	2	X1175-96	97	water bottle	1
X1175-25	26	M10 x 110mm allen bolt	2	X1175-97	99	stationary bar grip	2
X1175-28	27	M4 x 19mm phillips screw	18	X1175-98	100	stationary bar	1
X1175-27	28	foot tube cover	2	X1175-99	101	small end plug	2
X1175-28	29	foot tube plug	4	X1175-102	104	monitor mount	1
X1175-29	30	right foot tube	1	X1175-108	110	M5 x 10mm phillips bolt (silver)	4
X1175-30	31	metal washer	2	X1175-109	111	monitor plate	1
X1175-31	32	M8 x 20mm allen bolt	17	X1175-110	112	M5 x 10mm phillips bolt	4
X1175-33	35	roller	2	X1175-111	113	monitor	1
X1175-35	37	wheel cap	2	X1175-114	116	AC adapter wire	1
X1175-42	44	large washer	2	X1175-115	117	M5 x 25mm phillips screw	2
X1175-46	47	M4 x 16mm phillips screw	8	X1175-118		allen wrench	1
X1175-47	48	right shroud	1	X1175-119		multi "T" tool w/phillips screwdriver	1
X1175-48	49	right cover	1	X1175-FP		fastener pack	1
X1175-49	50	M4 x 10mm phillips screw	4	X1175-MC		master carton	1
X1175-50	51	rear end cap	2	X1175-OM		owners manual	1
X1175-51	52	short leveler	2				
X1175-52	53	AC adapter	1				

RECOVERY FUNCTION

During a workout, this button can be pressed to activate a resting period for 1 minute. The program will automatically go into Recovery, if you exceed the pulse rate that was entered before the workout begins.

MANUAL PROGRAM (Program 1)

After selecting the Manual program, you can edit all the parameters in this program by pressing Up or Down on the Key Pad. Once a desired parameter is met, press Select to move to the next parameter. The Start/Stop button will begin the Manual Program exercise. During this exercise, Up/Down adjusts resistance load during the workout.

PRE-PROGRAM (Programs 2-7)

There are 6 programs to select and the profiles are located on page 16. All program profiles have 16 levels of resistance.

After a program has been selected, pressing Enter will make the Time Parameter flash. Then, by pressing Up or Down you can select the desired Time value and then press Enter. You can edit other parameters, and pressing Start/Stop will begin the workout.

BODY FAT PROGRAM (Program 8)

- 1) Select the Body Fat (B.F.) Program and press Enter.
- 2) Then select your Gender (Male or Female) and press Enter, select your Age (in years) and press Enter, select your Height (feet then inches) and press Enter, select your weight (in pounds) and press Enter, hit Start, and then grasp the hand pulse sensors for fifteen seconds.
- 3) The display will then show your BMI "Body Mass Index" and your estimated Body Fat percentage. Below is a chart pertaining to Body Mass Index.

BMI (Body Mass Index)	Weight Status
Below 18.5	Underweight
18.5 - 24.9	Normal
25.0 - 29.9	Overweight
30.0 and Above	Obese

Body Type	Female	Male
Athlete	<17%	<10%
Lean	17-22%	10-15%
Normal	22-25%	15-18%
Above Average	25-29%	18-20%
Over fat	29-35%	20-25%
Obese	35+%	25+%

TARGET HEART RATE PROGRAMS (Programs 9-12)

Direct Target Heart Rate Setting (Program 9)

This Heart Rate setting is entered directly by the user. All parameters can be entered by the user. A Target Heart Rate must be entered by the user, but the default value is 90.

60% Target Heart Rate (Program 10)

This Target Heart Rate is set indirectly by using your age. All parameters can be entered by the user. It will then use your age to create the proper exercise.

75% Target Heart Rate (Program 11)

This Target Heart Rate is set indirectly by using your age. All parameters can be entered by the user. It will then use your age to create the proper exercise.

85% Target Heart Rate (Program 12)

This Target Heart Rate is set indirectly by using your age. All parameters can be entered by the user. It will then use your age to create the proper exercise.

(continued on next page)

OPERATING THE MONITOR

WARNING

Do not plug AC Adapter into wall until monitor is completely assembled.



INTRODUCTION

This Monitor provides different programs designed to tailor to your fitness goals. Simply choose the program you like, set the parameters and begin exercising. The Monitor will display calories, RPM, time, speed, wattage, pulse, heart rate and distance.

IMPORTANT

Always consult with your physician before beginning any exercise program. If you are taking medication which may affect your heart rate, a physician's advice is absolutely essential.

WARNING

Do not attempt to open the back cover of the Monitor console. This is not a battery storage area; this Monitor is powered by an AC Adapter. This unit is to be used only indoors and in a dry location. Do not plug the AC Adapter into the wall until the electronics monitor is completely assembled.

DATA INPUT BUTTONS

- 1. START/STOP** To Start or Stop a workout, press this button. Start Body Fat Measurement and quit the Body Fat Measurement.
- 2. DOWN** Decreases the value of a selected workout parameter. During the workout, it will decrease the resistance load.
- 3. UP** Increases the value of a selected workout parameter. During the workout, it will increase the resistance load.
- 4. ENTER** To input desired value or workout mode.
- 5. TEST** Press to enter into Recovery function when the Monitor has the heart rate value. Recovery is Fitness Level 1-6 after one minute. F1 is the best, and F6 is the worst.
- 6. MODE** Press to switch display from RPM to SPEED, and ODO to DIST during workout.

USING YOUR MONITOR

Plug the AC Adapter into the unit and then into a 110 volt electrical socket to turn the Monitor on. When the Monitor is first turned on, the display will emit a beep as the entire LCD Display lights up.

Press Up or Down on the Key Pad to move to the desired program. When the program is flashing, that is the program that would be selected. Press Enter to select the desired program. If the parameters in the program are at zero in the beginning of the workout, the parameters will count up from zero. During the workout, the Up and Down will increase (UP)/decrease (DOWN) the resistance load. The program profiles and functions are described in detail below and on the following pages.

Note: If there is no input signal for over 4 minutes, the system will enter Sleep Mode and all displays will turn off automatically. Simply re-starting your workout or pressing any button will result in the LCD screen powering up again.

Holding the Start/Stop button for three seconds will reset all function value to zero.

FUNCTION	DISPLAY VALUE
TIME (minutes)	00:00 - 99:00 (Count Up) 99:00 - 00:00 (Count Down)
SPEED (MPH)	0 - 99.5
DISTANCE (miles)	0.00 - 99.9
CALORIES	0 - 999
PULSE (Beats per minutes)	40 - 240

ECLIPSE 1175e EXPLODED VIEW

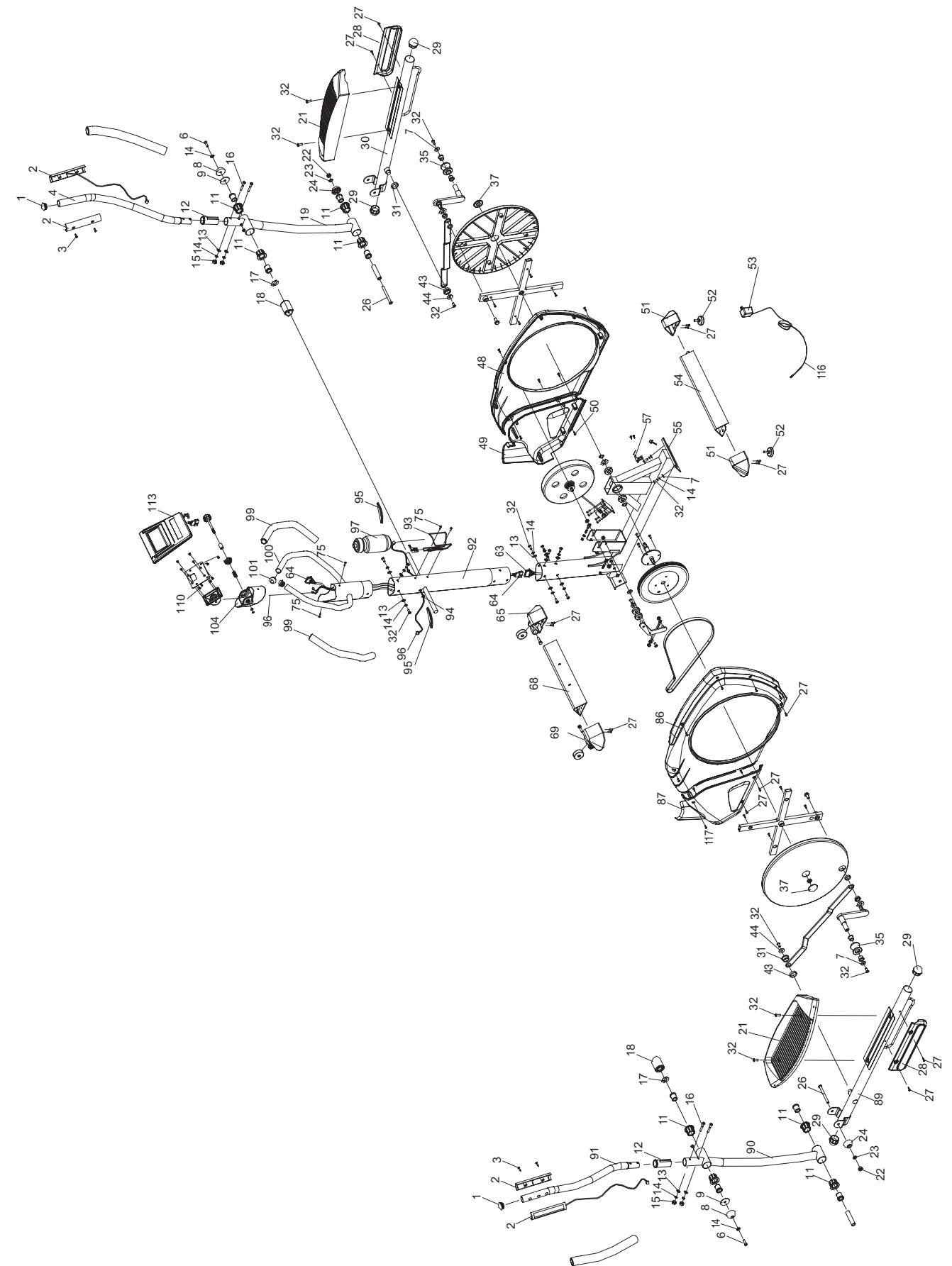

GETTING STARTED

Once your elliptical trainer is assembled, make sure that your workout space has a solid, level surface with plenty of space around it. We recommend placing a mat under your unit to protect your flooring. Before you begin your first workout on the elliptical trainer, practice getting on and off your trainer a few times until you are comfortable with this movement.

Getting On

Move the left foot platform to its lowest position.

- 1) Face forward and put your hands on the stationary handlebars.
- 2) Place your left foot on the left foot platform and balance yourself.
- 3) Carefully lift your right foot over the unit and place your right foot on the right foot platform. Make sure that you feel completely balanced before beginning your workout.

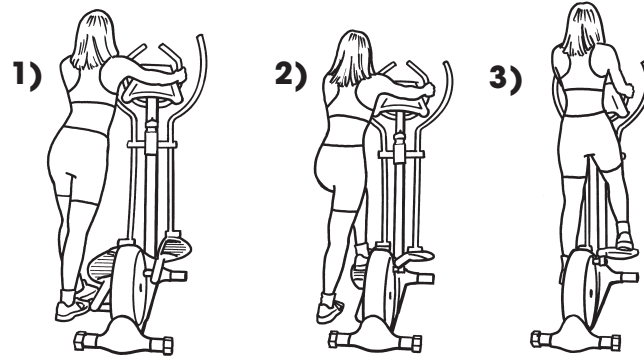

Getting Off

When stepping off, you must gradually slow down the rate at which you are pedaling until the unit comes to a complete stop.

- 1) Grasp the stationary handlebars with both hands (see Fig 3 above).
- 2) Step off the higher foot platform onto the floor (see Fig 2 above).
- 3) Then carefully bring your other foot over the unit and down to the floor (see Fig 1 above). Let go of the stationary handlebars.

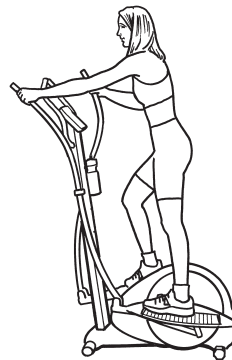

Correct Workout Position

When exercising, it is important to keep your back straight and knees "soft" or slightly bent. Do not lock out your knees. Keep your head up as this will minimize neck and upper back strain. Always try to use the elliptical trainer with a smooth and rhythmical motion.

CHANGING FOOT POSITIONS

The generously sized foot platforms are 7" wide by 16" long, which provides workout stability and allows you to vary your foot position for different workout intensities. Begin with your feet in the most forward position and then move your feet to the position that feels most comfortable to you. The further back your feet are placed on the foot platforms, the greater the vertical height of the elliptical motion and therefore, the harder the workout.

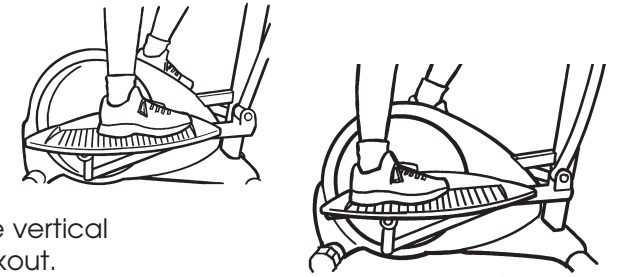

USING THE HANDLEBARS

Your elliptical trainer comes with both dual-action handlebars and stationary handlebars.

Dual-Action Handlebars

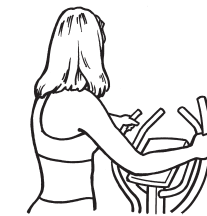

Place your hands midway between the top and bottom of the left and right arms on the dual-action handlebars. Adjust your hands up and down slightly to find the position most comfortable for you. Bend your elbows slightly so that your arms are not hyperextended or "locked out". Use a firm grip but try to avoid "white knuckles". As your legs move in the elliptical motion, pump your arms back and forth as if you were walking. Using the dual-action handlebars will work your upper body in addition to your lower body. By using the dual-action handlebars, you are recruiting more muscles which will both elevate your heart rate and burn more calories than simply doing a lower body workout.

Using the Pulse Function on the Dual-Action Handlebars

The pulse window on your monitor works in conjunction with the pulse sensors found on the dual-action handlebars. When you are ready to read your pulse:

- 1) Place both hands firmly on the pulse sensors. For the most accurate reading, it is important to use both hands and to temporarily stop moving.
- 2) Look at your pulse window. The small heart will begin to blink.
- 3) Your estimated heart rate will appear in the window approximately 6 seconds after you grasp the pulse sensors.
- 4) Refer to the Target Heart Rate Zone chart found on page 20 of this manual. For additional information about the importance of working within certain heart rate ranges, see pages 18 and 19 – *Measuring Your Heart Rate*.
- 5) This estimate is not exact and persons with medical conditions and/or a specific need for accurate heart rate monitoring should not rely on the estimations provided.

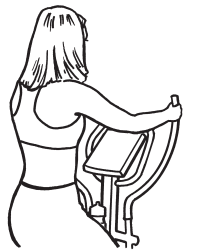

Stationary Handlebars

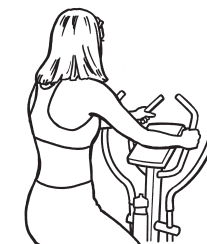

Place your hands midway between the top and bottom of the left and right arms on the stationary handlebars. Adjust your hands up and down until you find the position most comfortable for you. Bend your elbows slightly so that your arms are not hyperextended or "locked out". Using the stationary handlebars during your workout will decrease the amount of work in your upper body and increase the amount of work in your lower body.

USING YOUR ELLIPTICAL TRAINER

⚠ WARNING

RISK OF ELECTRICAL SHOCK. THIS UNIT IS TO BE USED ONLY INDOORS AND IN A DRY LOCATION.

The elliptical trainer, with its Orbital Linkage System, provides a completely smooth and natural feeling, elliptical path that minimizes the impact on your hips, knees and ankles while providing a superior aerobic and muscle toning workout. The durable steel frame and streamlined look make the equipment easy to use and easy to store, no matter what your space limitations.

IMPORTANT:

- This equipment is not recommended for children.
- Always wear rubber soled workout shoes.
- Always make sure that you feel balanced and secure.
- Always use your equipment on a clean, solid and level surface.

ADJUSTING THE LEVEL OF THE ELLIPTICAL TRAINER

The Short Levelers are located on the bottom of the Rear Foot Tube End Caps. To raise the Foot Tube, turn the Short Levelers counter-clockwise with the Allen Wrench provided. To lower the Foot Tube, turn the Levelers clockwise with the Allen Wrench. Make sure the elliptical trainer is level before exercising.

