



**Infant Seat**



**Toddler Seat**

## **Instructions**

Model Number: H5985



## **WARNING**

**IMPORTANT! KEEP FOR FUTURE REFERENCE.**

Please read these instructions before assembly and use of this product.

Use the upright position only when your child has developed enough upper body control to sit without leaning forward.

Always use the restraint until your child is able to climb in and out of the chair unassisted.

Adult assembly is required. Tool needed for assembly: Phillips Screwdriver (not included).

Requires one LR20 ("D") alkaline battery (not included) for vibrations unit operation.



[www.fisher-price.com](http://www.fisher-price.com)



# WARNING

## To prevent serious injury or death:

- It is dangerous to use this product on an elevated surface.
- Never use on a soft surface (bed, sofa, cushion) since product can tip over and cause suffocation in soft surfaces.
- Always use the restraint until child is able to climb in and out of the chair unassisted.
- Never leave child unattended.
- Use the upright position only when child has developed enough upper body control to sit without leaning forward.
- Never use as a carrier or lift while child is seated. Never use the toy bar as a handle.
- Reclined position not recommended for children who can sit up by themselves (6 months approximately, until 9 kg.).



# CAUTION

This package contains small parts in its unassembled state.

Adult assembly is required.

## Parts

**IMPORTANT!** Please remove all parts from the package and identify them before assembly. The kickstand is packaged within the pad at the factory. Before beginning assembly, please remove kickstand from the pad.

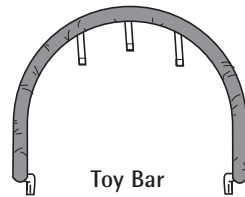

Toy Bar

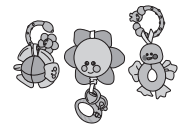

3 Toys

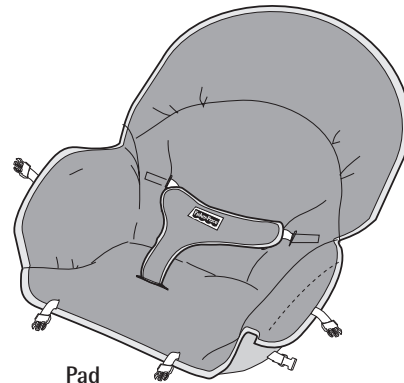

Pad

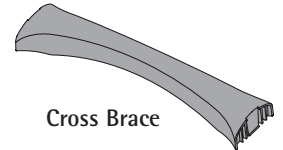

Cross Brace



2 Retainers with Lock Nut

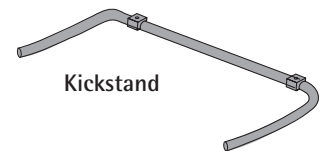

Kickstand

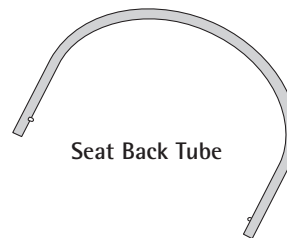

Seat Back Tube

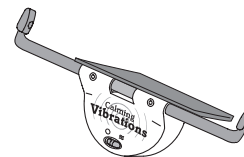

Front Tube

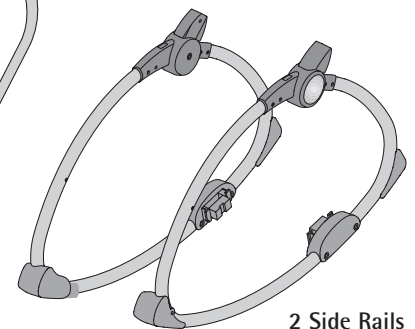

2 Side Rails



M4 Lock Nut (Inside Retainers) - 2



#8 x 2.9 cm Screw - 2

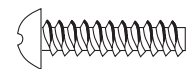

#8 x 1.9 cm Screw - 2

All Shown Actual Size

**Note:** Tighten or loosen all screws with a Phillips screwdriver. Do not over-tighten.

# Assembly

**IMPORTANT!** Before assembly or each use, inspect this product for damaged hardware, loose joints, missing parts or sharp edges. DO NOT use if any parts are missing, damaged or broken. Contact Mattel for replacement parts and instructions if needed. Never substitute parts.

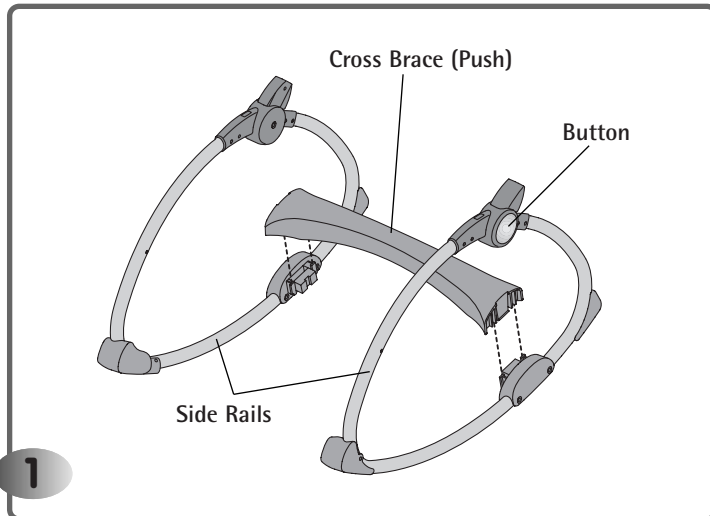

- 1
- Position each side rail so that the button faces outward.
  - Fit the cross brace between the side rails, as shown.
  - Push the cross brace down to "snap" it into place. This may require a lot of force.

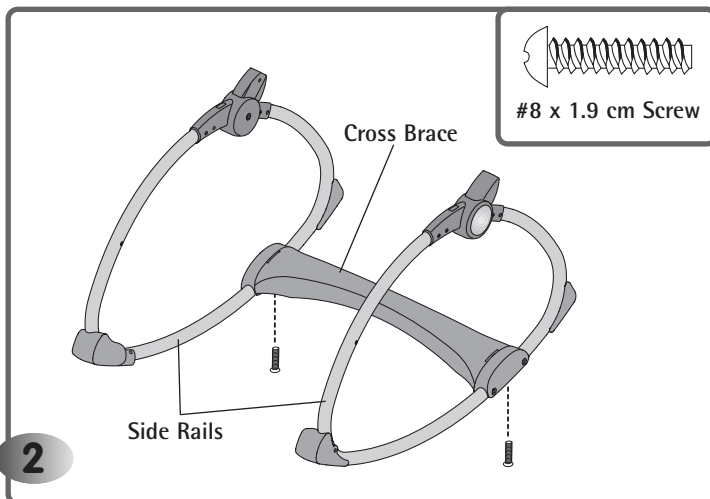

- 2
- Insert a #8 x 1.9 cm screw through the hole in the bottom of each side rail and into the cross brace. Tighten the screws with a Phillips screwdriver. Do not over-tighten.

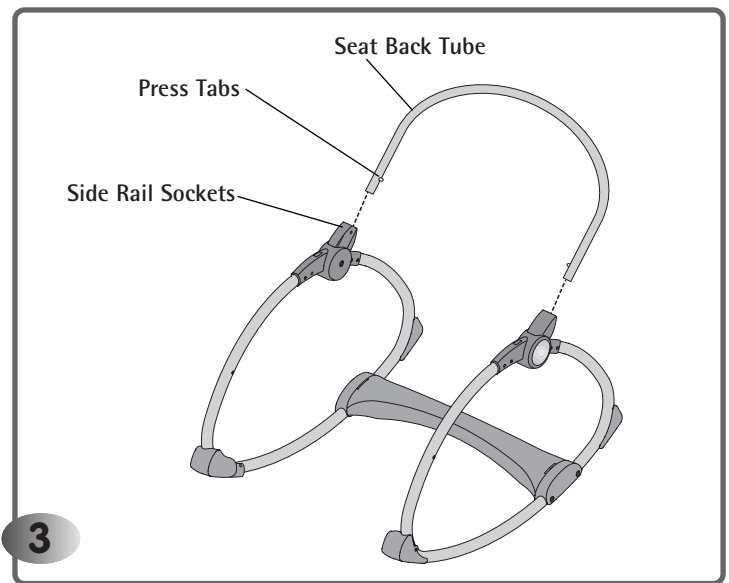

- 3
- Insert the seat back tube into the socket in each side rail.
  - While pressing the tabs on the ends of the seat back tube, continue to insert the seat back tube into the sockets in each side rail, until the tabs "snap" into place. Make sure you hear a "snap" on each side.
  - Pull the seat back tube up to be sure it is secure in the side rail sockets.

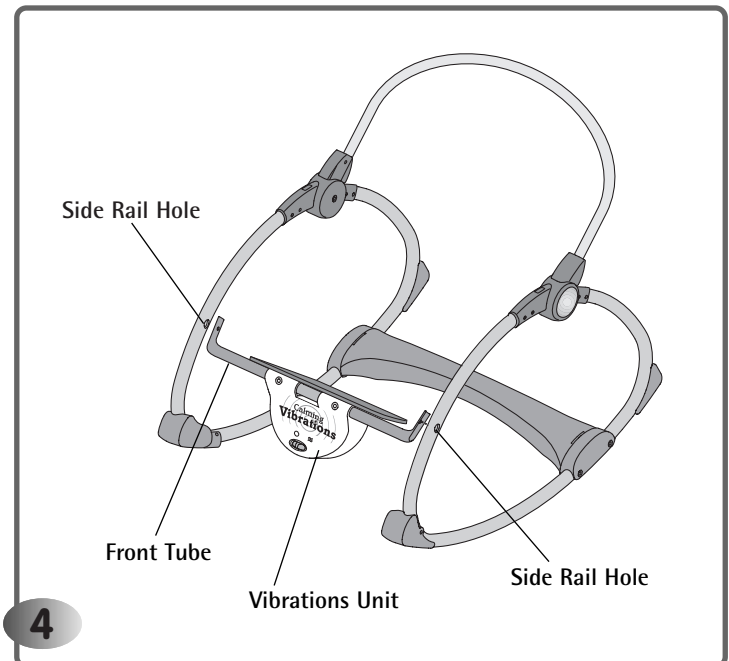

- 4
- Locate the hole in each side rail.
  - With the vibrations unit facing forward, fit the front tube to the side rails, as shown. Hold the front tube in place and proceed to step 5.

# Assembly

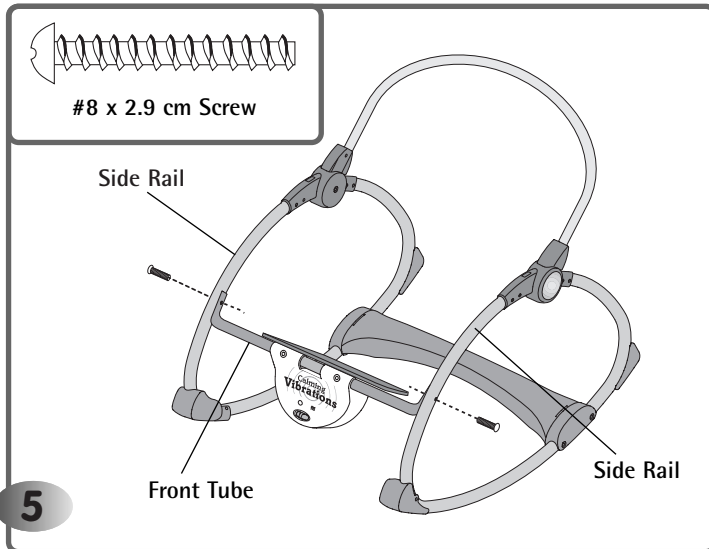

- Insert a #8 x 2.9 cm screw through the outside of each side rail and into the ends of the front tube.
- IMPORTANT!** Please follow the next assembly (step 6) carefully to completely secure the front tube to the side rails.

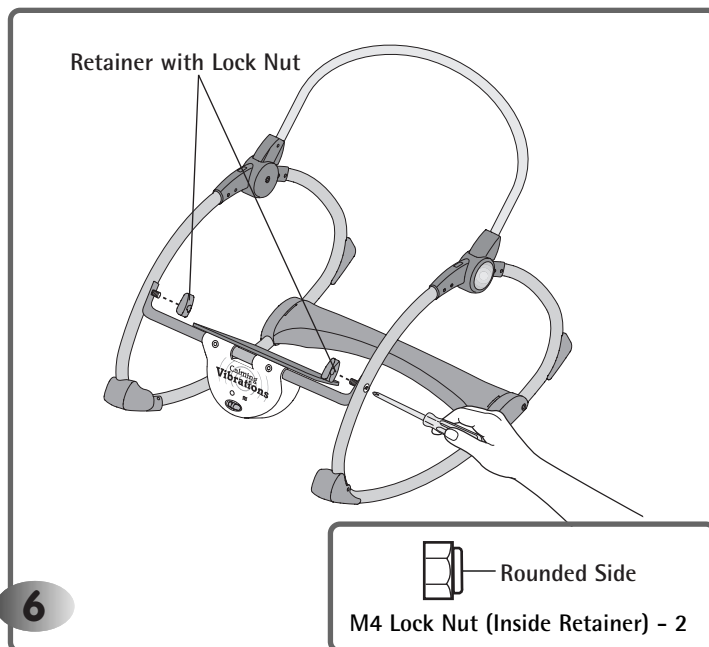

- Fit a retainer with lock nut onto the end of the screw and to the inside of a side rail.
- Hint:** A lock nut has been factory assembled to the retainer. During shipment, the lock nut may have fallen out of the retainer. If it has, please fit it into the hexagonal hole in the retainer so that the rounded side of the lock nut faces out.
- Tighten the screw with a Phillips screwdriver. Do not over-tighten.
  - Repeat this procedure to fasten the screw in the other end of the front tube and side rail, using the remaining retainer with lock nut.

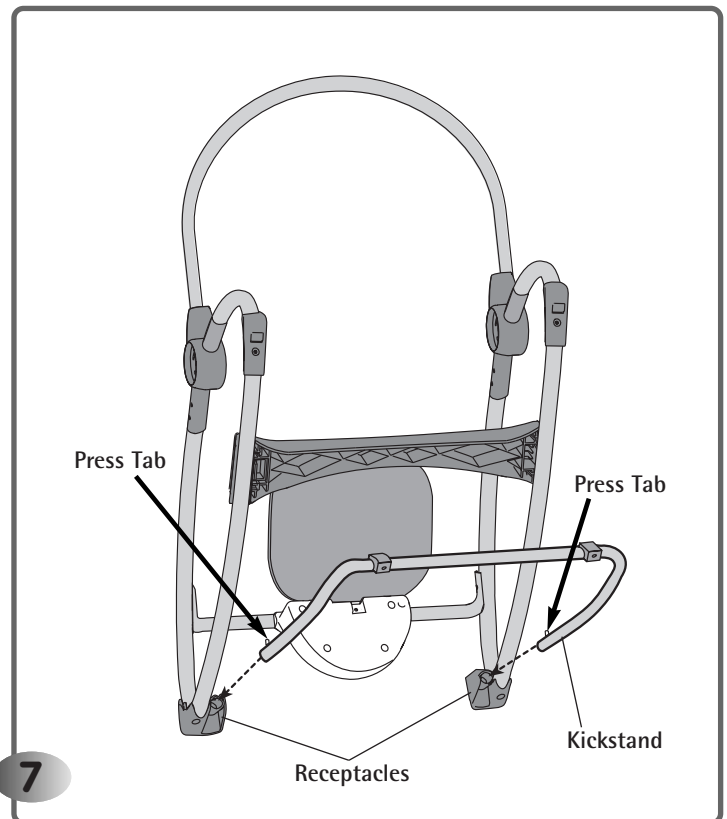

- Position the assembly face down, as shown.
- While pressing the tab on each end of the kickstand, insert the kickstand into the receptacle in each side rail, as shown.
- Push the kickstand into the receptacles until the tabs "snap" into place. Make sure you hear a "snap" on each side.
- Pull the kickstand to be sure it is secure in the receptacles.

# Assembly

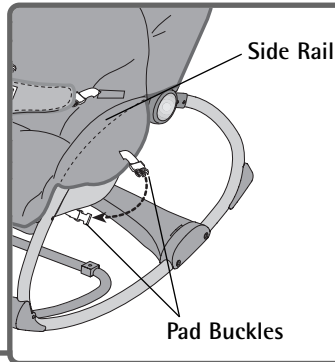
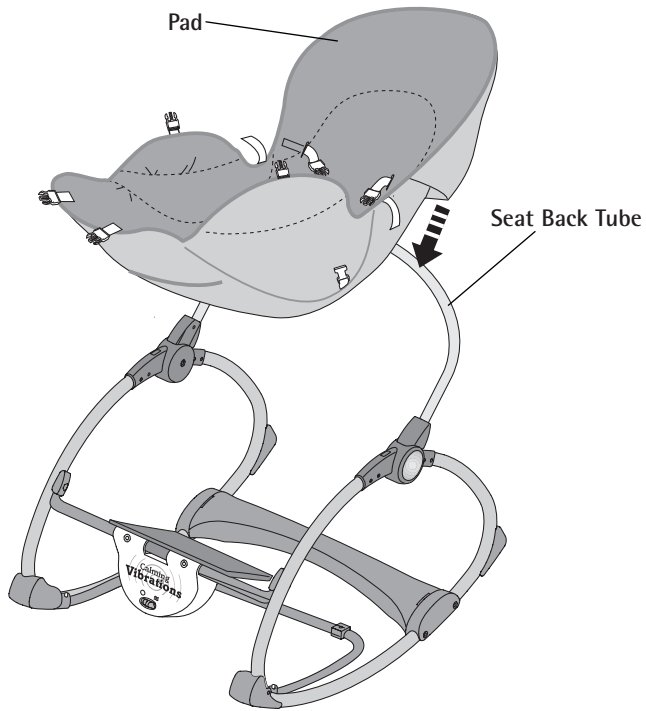

8

- Turn the assembly upright.
- Fit the upper pocket on the pad onto the seat back tube.
- Fasten the pad buckles around each side rail.

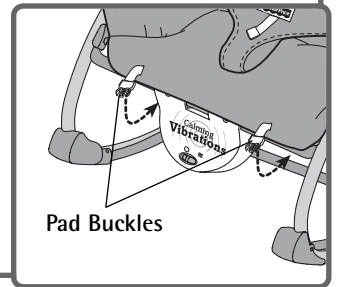
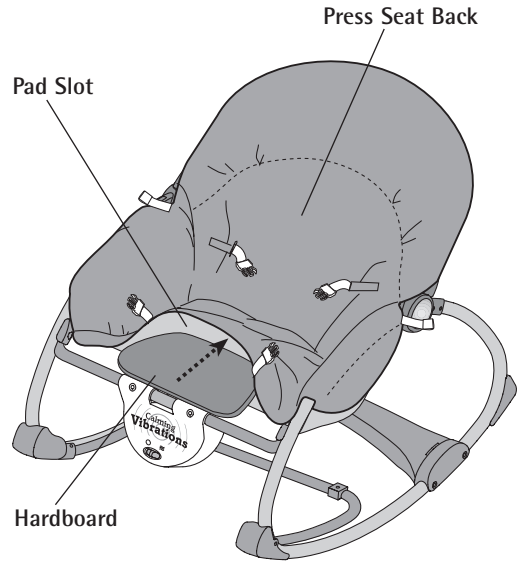

9

- Turn the hardboard over and insert it into the slot in the front edge of the pad.
- Fasten the pad buckles on the front edge of the pad and underneath the seat. **Make sure you hear a "snap" on both sides.**
- Press the fasteners together in the seat back portion of the pad.

## Battery Installation

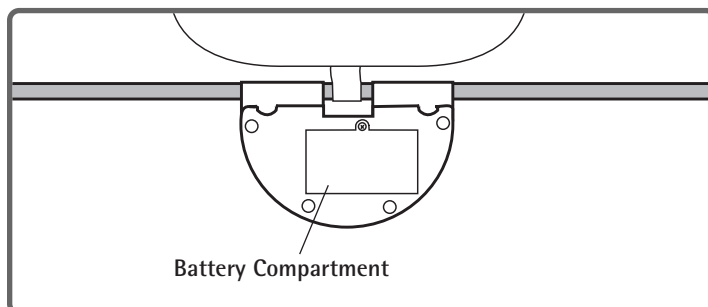
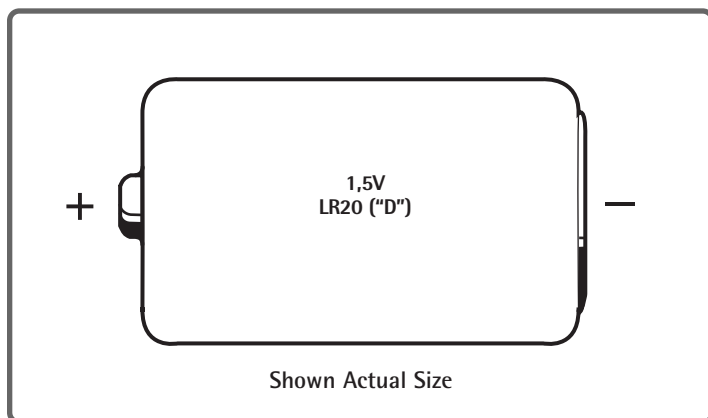

- Locate the battery compartment on the bottom of the vibrations unit.
- Loosen the screw in the battery compartment door with a Phillips screwdriver.
- Lift to remove the battery compartment door.
- Insert one LR20 ("D") **alkaline** battery as indicated inside the battery compartment.

**Hint:** We recommend using **alkaline** batteries for longer battery life.

- Replace the battery compartment door and tighten the screw with a Phillips screwdriver. Do not over-tighten.

## Battery Safety Information

Batteries may leak fluids that can cause a chemical burn injury or ruin your product. To avoid battery leakage:

- Do not mix old and new batteries or batteries of different types: alkaline, standard (carbon-zinc) or rechargeable (nickel-cadmium).
- Insert batteries as indicated inside the battery compartment.
- Remove batteries during long periods of non-use. Always remove exhausted batteries from the product. Dispose of batteries safely. Do not dispose of batteries in a fire. The batteries may explode or leak.
- Never short-circuit the battery terminals.
- Use only batteries of the same or equivalent type, as recommended.
- Do not charge non-rechargeable batteries.
- Remove rechargeable batteries from the product before charging.
- If removable, rechargeable batteries are used, they are only to be charged under adult supervision.

## Setup and Use

**IMPORTANT!** Before each use, inspect this product for damaged hardware, loose joints, missing parts or sharp edges. DO NOT use if any parts are missing or broken. Contact Mattel for replacement parts and instructions if needed. Never substitute parts.



### WARNING

#### To prevent serious injury or death:

- Reclined position not recommended for children who can sit up by themselves (6 months approximately, until 9 kg.).
- Use the upright position only when child has developed enough upper body control to sit without leaning forward.

### Seat Position

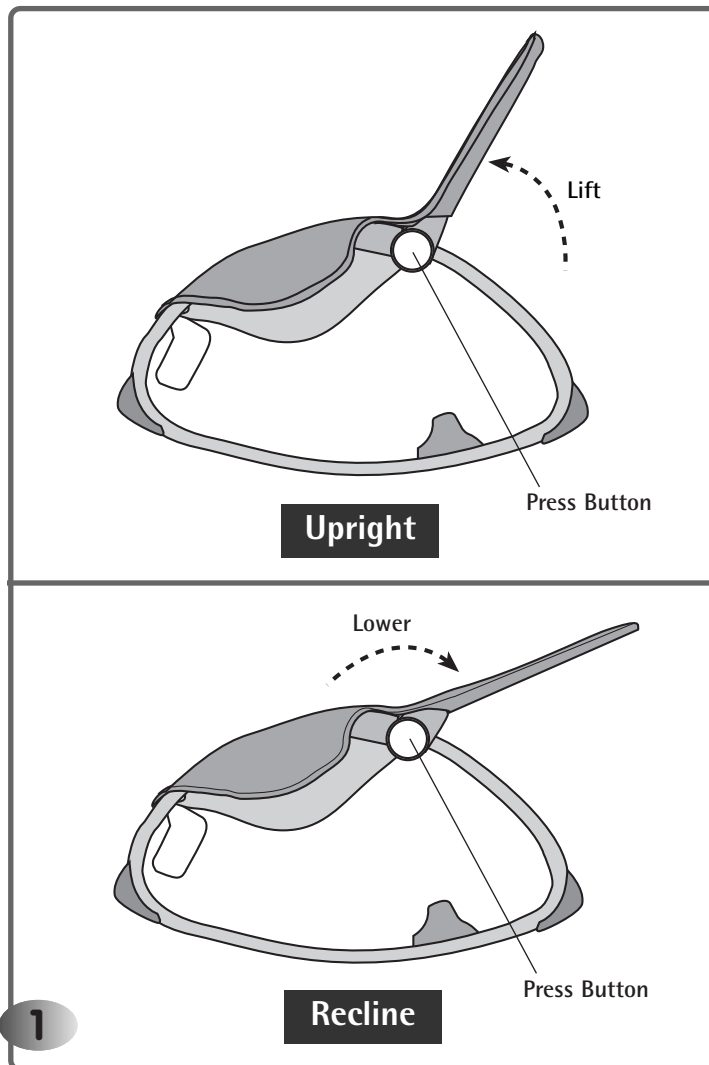

Select a seat position for your child's comfort:  
**Upright or Recline.**

#### **Upright**

While pressing the button on each side rail, lift the seat back.

#### **Recline**

While pressing the button on each side rail, lower the seat back.

## Securing Your Infant

### WARNING

#### To prevent serious injury or death:

- Always use the restraint until child is able to climb in and out of the chair unassisted.
- It is dangerous to use this product on an elevated surface.
- Never leave child unattended.

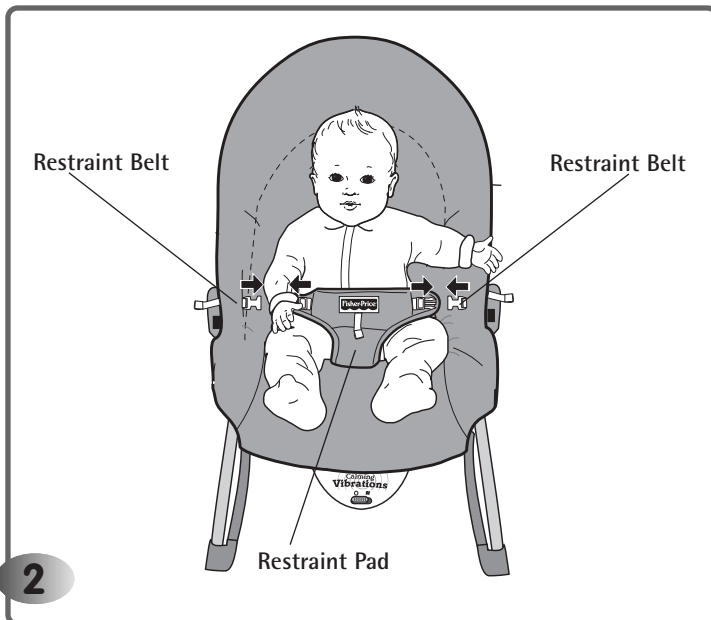

- Place your child in the seat. Position the restraint pad between your child's legs.
- Fasten the restraint belts to each side of the restraint pad. **Make sure you hear a "click" on both sides.**
- Check to be sure the restraint system is securely attached by pulling it away from your child. The restraint system should remain attached.

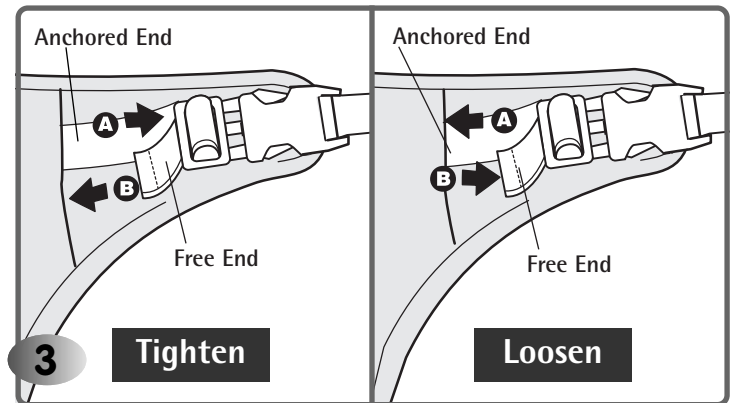

**To tighten the belts:** Feed the anchored end of the restraint belt up through the buckle to form a loop **A**. Pull the free end of the restraint belt **B**. Repeat this procedure to tighten the other restraint belt.

**To loosen the belts:** Feed the free end of the restraint belt up through the buckle to form a loop **A**. Enlarge the loop by pulling on the end of the loop toward the buckle. Pull the anchored end of the restraint belt to shorten the free end of the restraint belt **B**. Repeat this procedure to loosen the other restraint belt.



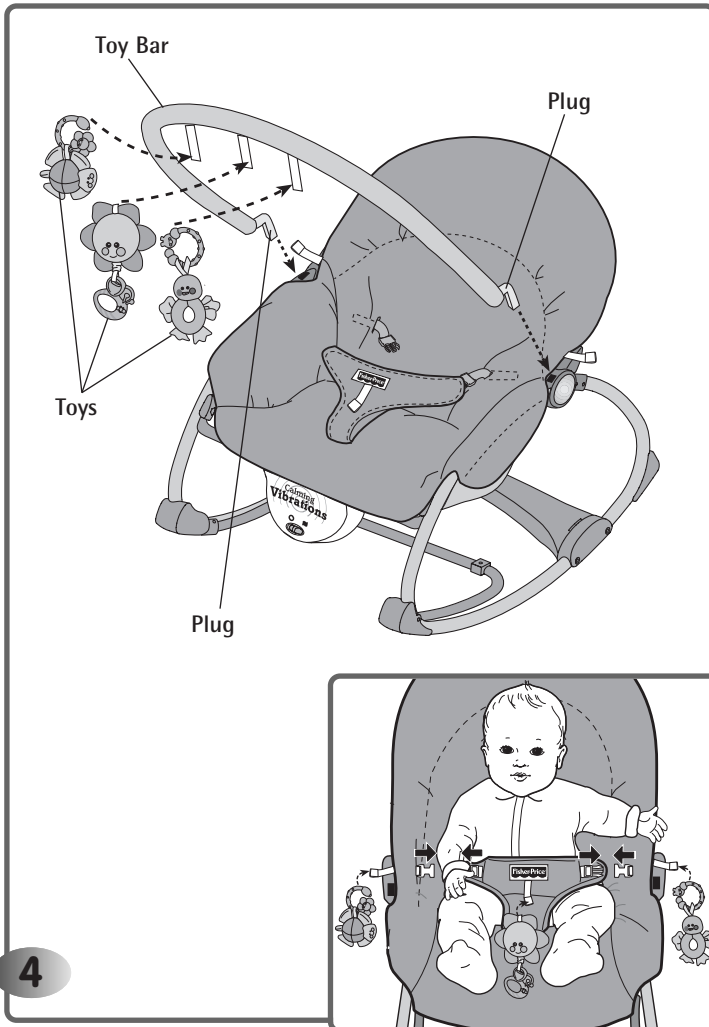

## Toy Bar

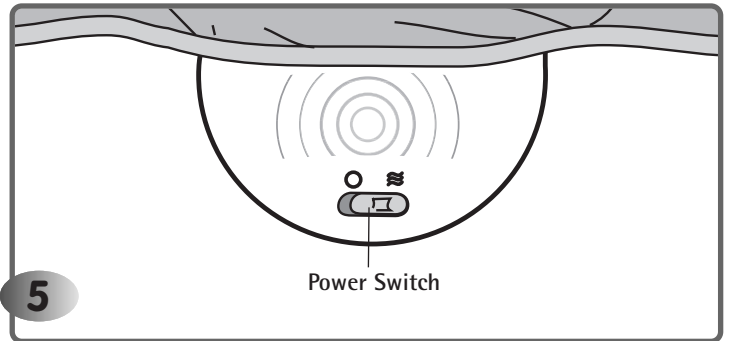

- Fit the plugs on each end of the toy bar into the sockets in each side rail.
- Fit the toy bar straps through the slot in the toy rings. Fasten the straps.
- Or, attach the toys to the pad straps.

## Calming Vibrations



- Make sure your child is properly secured in the seat.
- Slide the power switch to the  on position for calming vibrations.
- Slide the power switch to the  off position to turn vibrations off.

## Kickstand

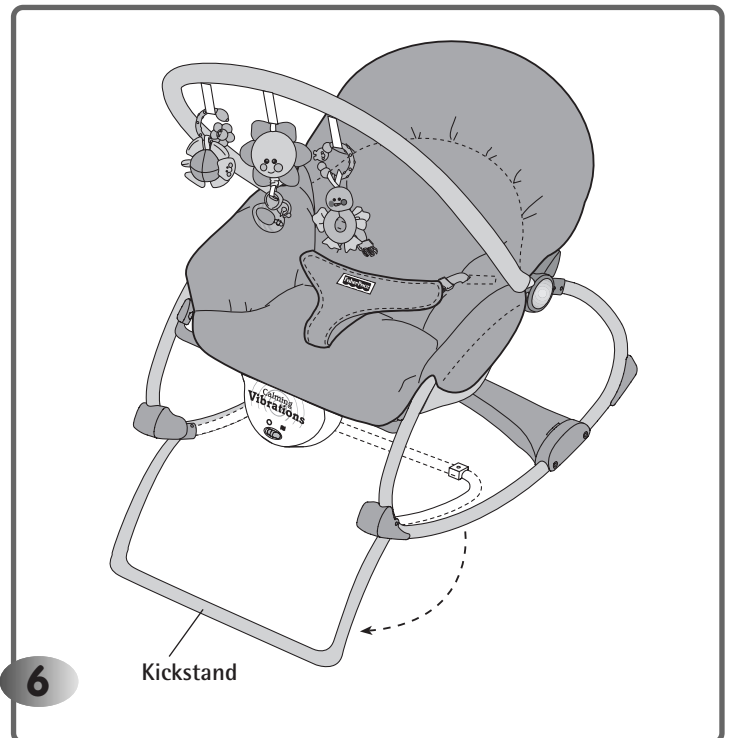

- Rotate the kickstand out.
- Push down on the seat bottom to be sure the kickstand is in position.

## Storing the Restraint System for Toddler Use

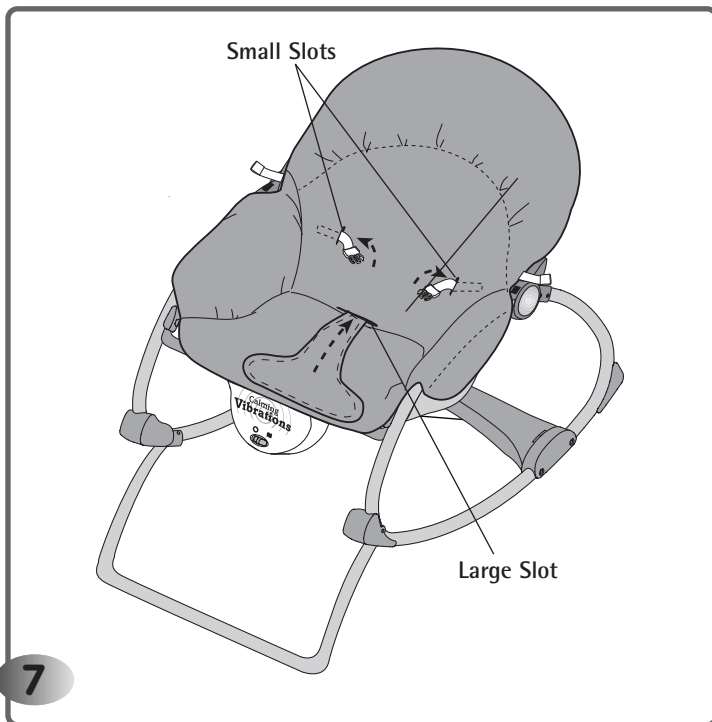

- Insert the restraint belts back through the small slots in the pad.
- Insert the restraint pad down through the large slot in the pad.

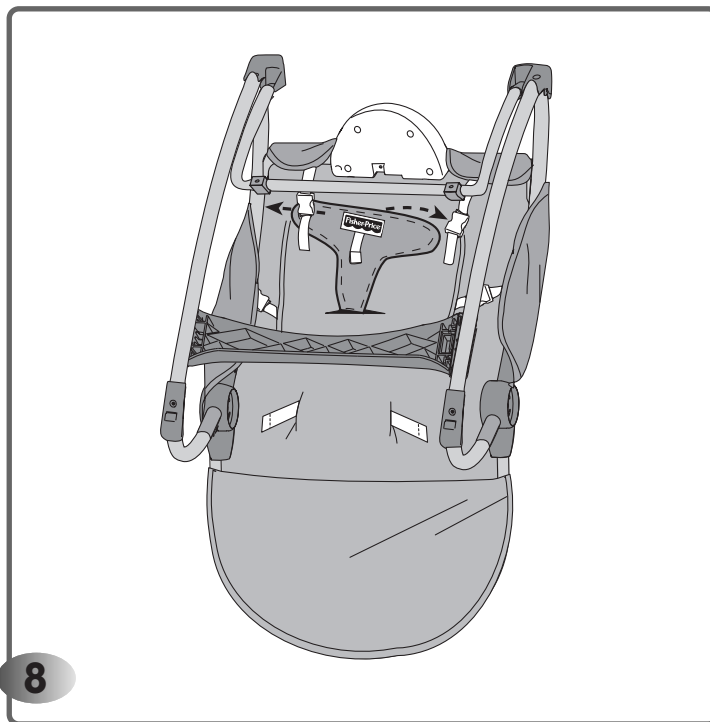

- Turn the rocker face down.
- Tuck the ends of the restraint pad underneath the buckles, as shown.

## Care

- The pad is machine washable. Wash the pad separately in cold water on the gentle cycle. Do not use bleach. Line dry.
- The frame, toy bar and toys may be wiped clean using a mild cleaning solution and a damp cloth. Do not use bleach. Do not use harsh or abrasive cleaners. Rinse clean with water to remove residue.

### To remove the pad:

- Unfasten the buckles around each side rail.
- Turn the seat face down on a flat surface. Unfasten the buckles on the pad.
- Turn the seat upright. Remove the hardboard from the slot in the front edge of the pad.
- Pull the front and back of the seat back area of the pad apart.
- Lift the pad off the seat.

**To replace the pad,** refer to Assembly steps 8 and 9.

## Consumer Information

### GREAT BRITAIN

Mattel UK Ltd, Vanwall Business Park, Maidenhead SL6 4UB.  
Helpline: 01628 500302.

### AUSTRALIA

Mattel Australia Pty. Ltd., 658 Church Street,  
Locked Bag #870, Richmond, Victoria 3121 Australia.  
Consumer Advisory Service 1300 135 312.

### ASIA

Mattel East Asia Ltd, Room 1106, South Tower,  
World Finance Centre, Harbour City, Tsimshatsui, HK, China.

### MALAYSIA

Diimport & Diedarkan Oleh: Mattel SEA Ptd Ltd. (993532-P)  
Lot 13.5, 13th Floor, Menara Lien Hoe, Persiaran Tropicana Golf  
Country Resort, 47410 PJ. Tel: 03-78803817, Fax: 03-78803867.

©2004 Mattel, Inc. All Rights Reserved.  
© and ™ designate U.S. trademarks of Mattel, Inc.  
Fisher-Price, Inc., a subsidiary of Mattel, Inc., East Aurora, New York 14052, U.S.A.