



# Smart Response™ Swing



Product features and decorations may vary from picture above.  
Accessories sold separately.

**Model Number: B2108, B3469, G5175**

PLEASE KEEP FOR FUTURE REFERENCE.

Please read these instructions before assembly and use of this product, as they contain important information.

Adult assembly is required.

Tool needed for assembly: Phillips Screwdriver (not included).

Requires four "D" (LR20) **alkaline** batteries for operation.

Maximum Weight Limit: 24 lbs. (10.9 kg).

**IMPORTANT!** The maximum weight limit for this product is 24 lbs. If your child weighs less than 24 lbs., but is really active and appears to be able to climb out of the swing, immediately discontinue its use.

[www.fisher-price.com](http://www.fisher-price.com)

## *Warnings and Caution*



### **WARNING**

- To prevent serious injury or death from falls and being strangled in the restraint system:
  - Always use the restraint system. Never rely on the tray to restrain child.
  - Never use with an active child who may be able to climb out of the seat.
- Never leave child unattended.



### **CAUTION**

This product contains small parts in its unassembled state. Adult assembly is required.

## *Consumer Information*

Occasionally a consumer may experience a problem with one of our products. If this should happen, please call us toll-free, rather than return this product to the store. Usually, we can solve the problem over the telephone or send you replacement parts. Please call Fisher-Price® Consumer Relations, toll-free at **1-800-432-5437**, 8 AM - 6 PM EST Monday through Friday. Hearing-impaired consumers using TTY/TDD equipment, please call 1-800-382-7470.

Or, write to:  
Fisher-Price®  
Consumer Relations  
636 Girard Avenue  
East Aurora, New York 14052

# Parts

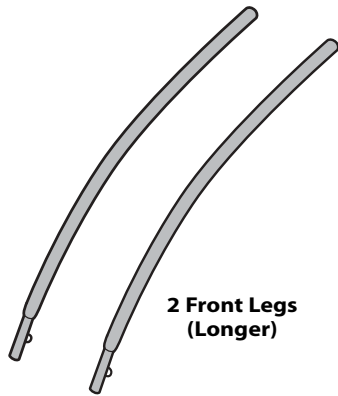

2 Front Legs (Longer)

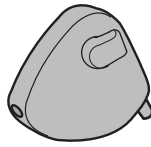

Housing



2 Rear Legs (Shorter)



2 Accessory Bins

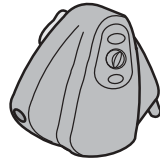

Motor Housing



Toy Bar (Toys may be different)

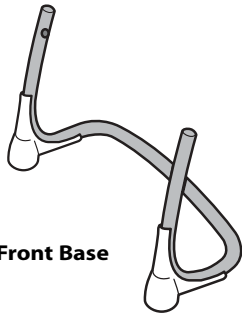

Front Base

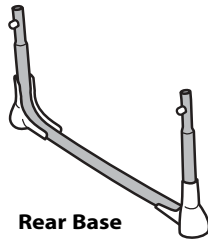

Rear Base

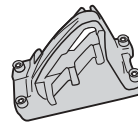

Bracket (with M4 Lock Nuts)

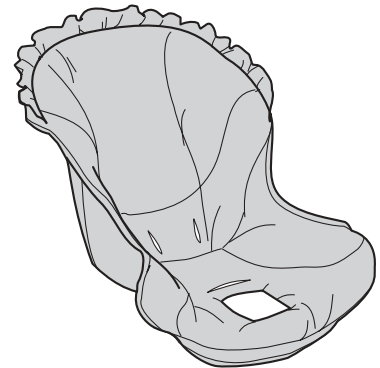

Pad



Seat with Restraint

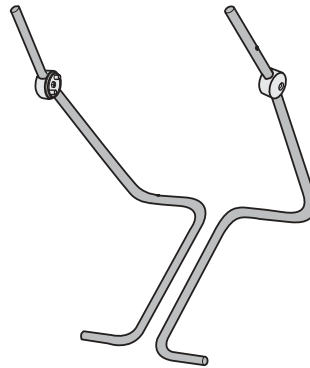

2 Seat Tubes



2 Seat Wire Caps



Seat Wire

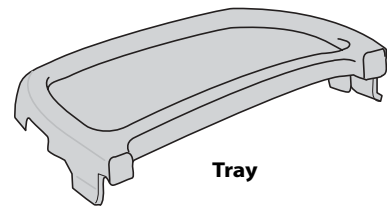

Tray

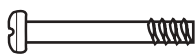

M4 Screw - 4  
Shown Actual Size

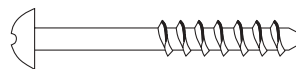

#8 x 1 3/8" Screw - 6  
Shown Actual Size



#6 x 5/8" Screw - 8  
Shown Actual Size

Note: Tighten or loosen all screws with a Phillips screwdriver. Do not over-tighten the screws.

# Assembly

**IMPORTANT!** Before assembly, inspect this product for damaged hardware, loose joints, missing parts or sharp edges. DO NOT use if any parts are missing or broken. Contact Fisher-Price® for replacement parts and instructions if needed. Never substitute parts.

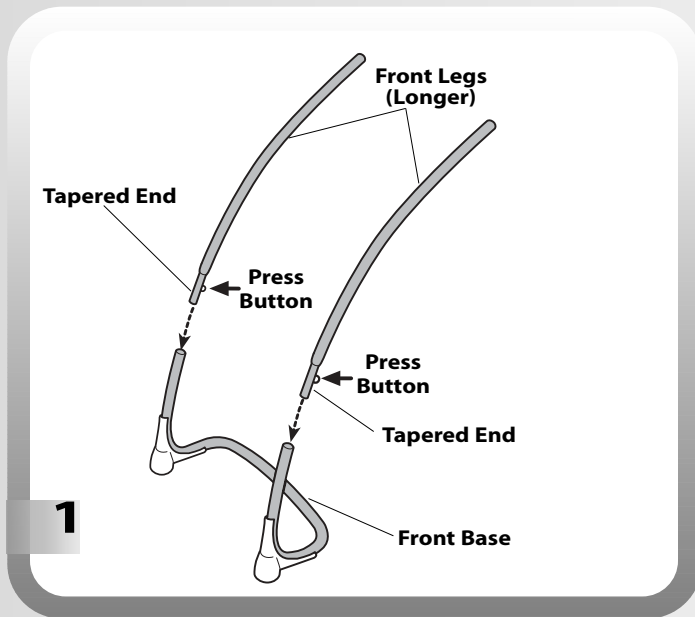

- Place the front base on a flat surface.
- Position a front leg (longer) so that the tapered end is downward, as shown.
- While pressing the button on one of the front legs, insert it into the front base. Push down on the front leg until the button “snaps” into the hole in the front base.
- Repeat this procedure to assemble the other front leg to the front base.

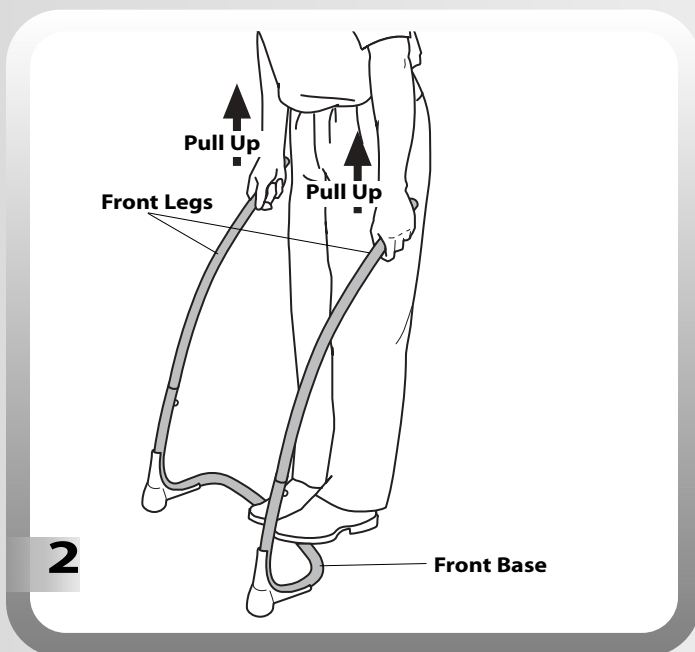

- While standing on the front base, pull the front legs up. The front legs should **remain secured** to the front base. If you can remove the front legs, you have not assembled them correctly to the front base. Reread and repeat assembly step 1.

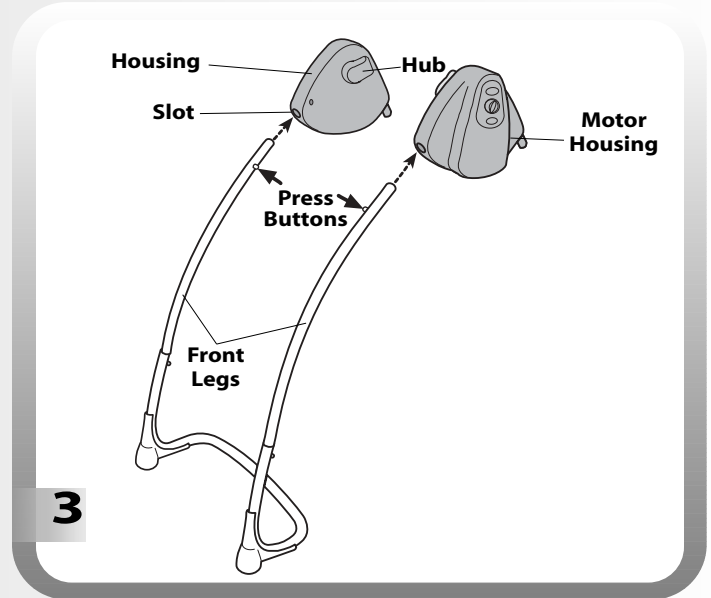

- Position the housing so that the hub is inward.
- While pressing the button on the top of front leg, insert it into the housing slot, as shown. Push the front leg until the button “snaps” into the hole in the housing.
- Repeat this procedure to assemble the motor housing to the other front leg.
- Pull the front legs down to be sure they are secure in the housings. If you can remove them, you have not assembled them correctly. Please re-read and repeat this assembly step.

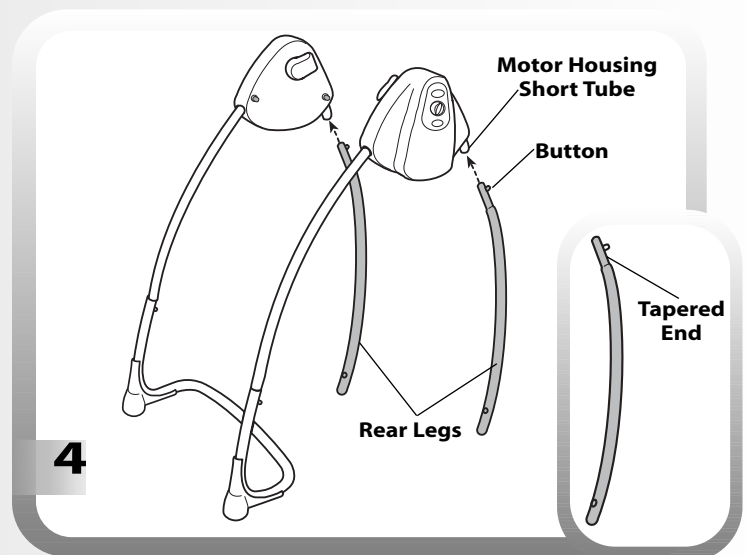

- Position a rear leg so that the tapered end is upright.
- While pressing the button on the top of the rear leg, insert it into the housing short tube, as shown. Push the rear leg until the button “snaps” into the hole in the short tube.
- Repeat this procedure to assemble the other rear leg to the motor housing short tube.
- Pull the rear legs down to be sure they are secure in the housings. If you can remove them, you have not assembled them correctly. Please re-read and repeat this assembly step.

# Assembly

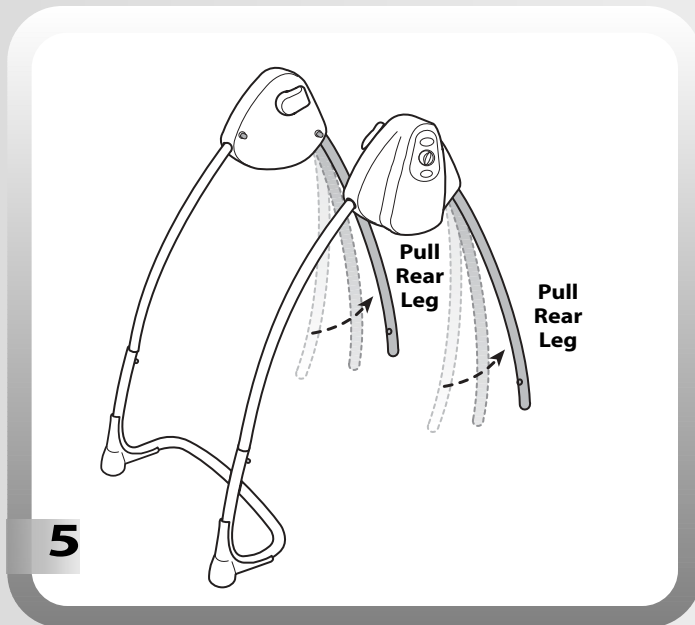

- Pull both rear legs out until they “snap” into place.

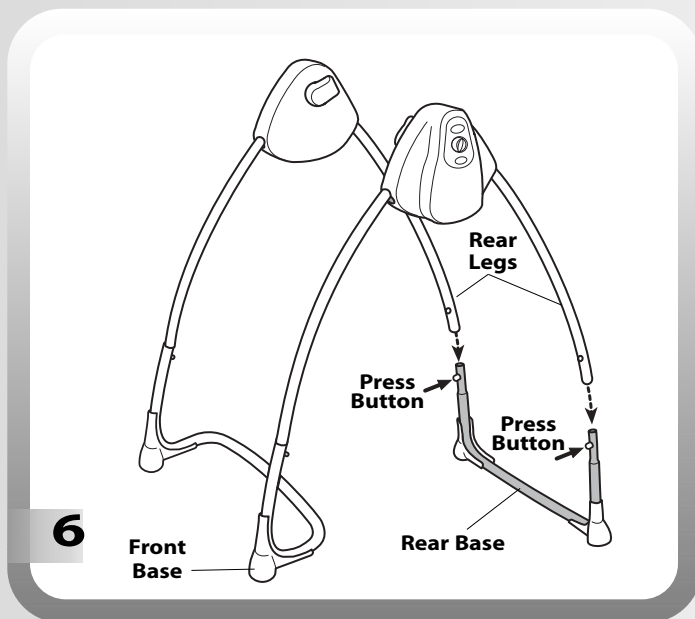

- Place the rear base on a flat surface so that the buttons face the front base.
- While pressing the buttons on each side of the rear base, fit the rear legs onto the rear base. Push the rear legs down until the buttons on the rear base “snap” into the holes in each rear leg.

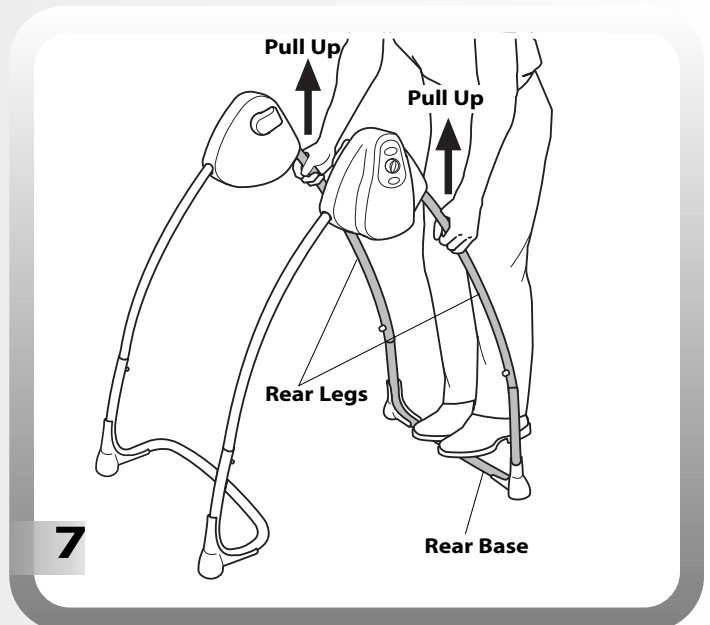

- While standing on the rear base, pull the rear legs up. They should remain secured to the rear base. If you can remove the rear legs, you have not assembled them correctly to the rear base. Reread and repeat assembly step 6.
- Set the frame assembly aside for Assembly step 17.

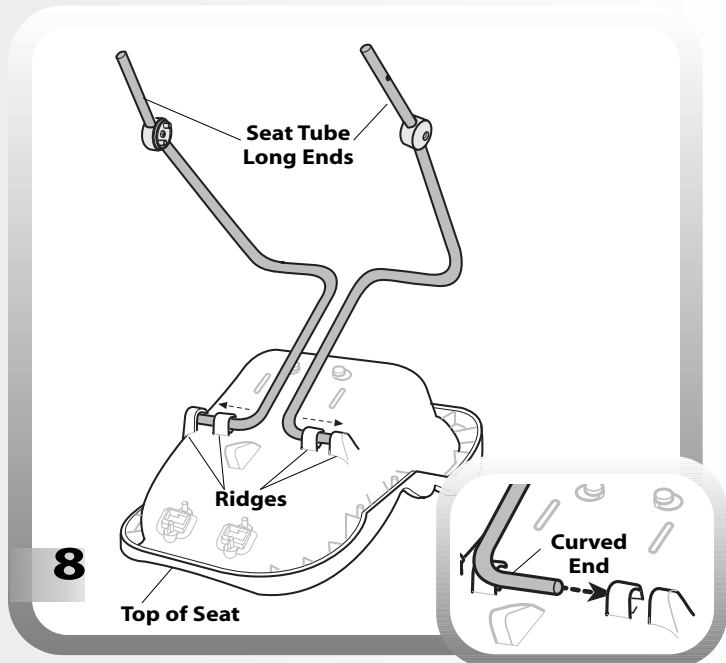

- Position the seat face down, with the top of the seat facing you.
- Position a seat tube so that the long end is upright and toward you and the curved end is toward the outside edge of the seat.
- Insert the curved end of the seat tube through the holes in the ridges on the seat back.
- Repeat this procedure to assemble the other seat tube to the seat.

# Assembly

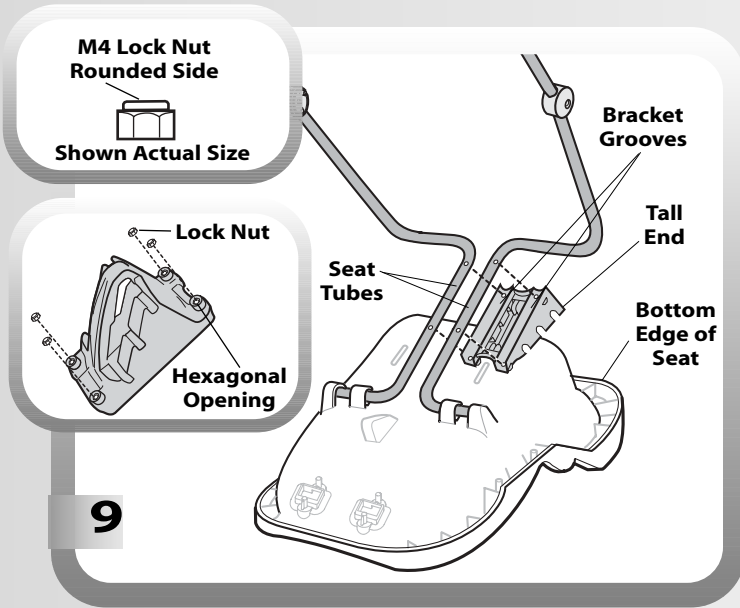

9

- Position the bracket so that the tall end is toward the bottom edge of the seat.

**Hint:** The M4 lock nuts have been assembled to the bracket at the factory. During shipment of this product, they may have fallen out. Check to be sure there is a lock nut in each hexagonal opening on the bracket. If one (or more) has fallen out, fit the lock nut into a hexagonal opening in the bracket. Make sure the rounded side of the lock nut is facing up.

- Fit the grooves on the bracket to the seat tubes, as shown.

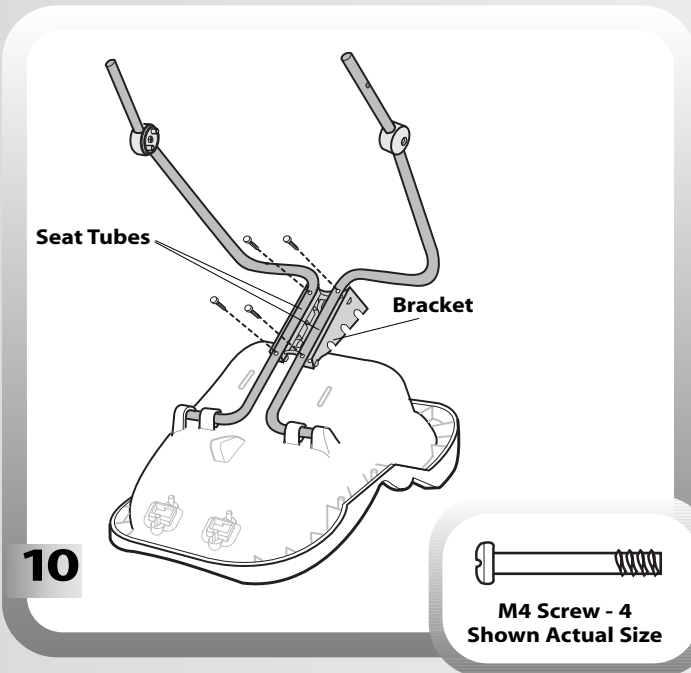

10

- Insert four M4 screws into the seat tubes and tighten.

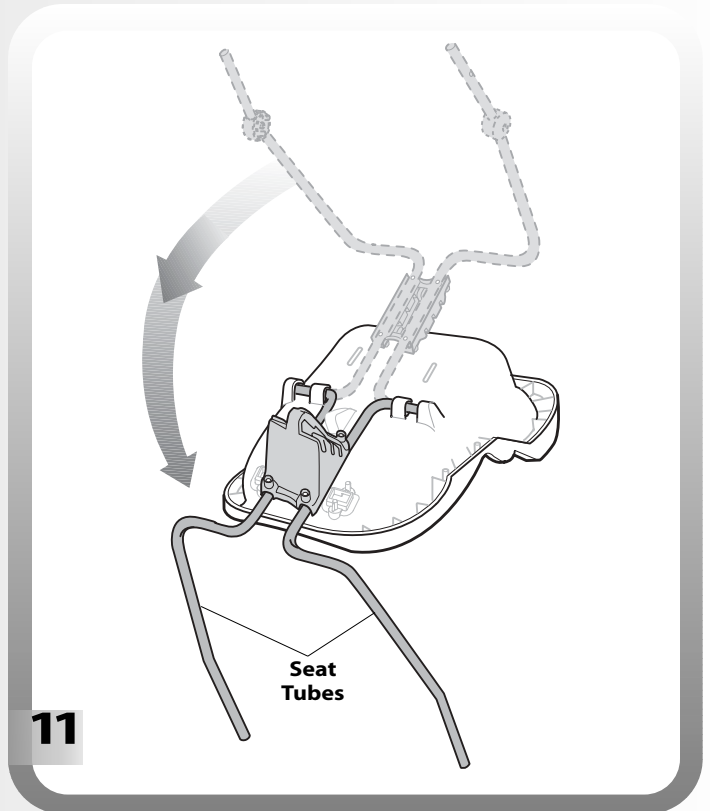

11

- Rotate the seat tubes down.

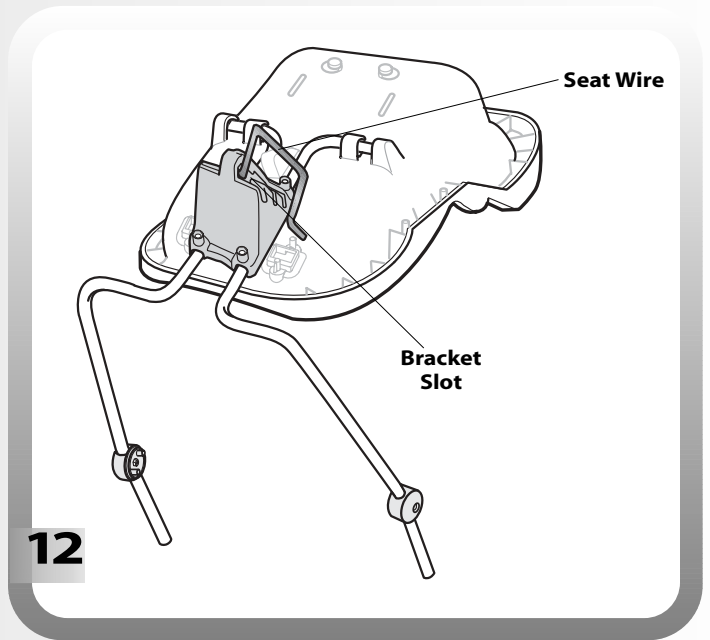

12

- Fit the seat wire through the slot in the bracket as shown.

# Assembly

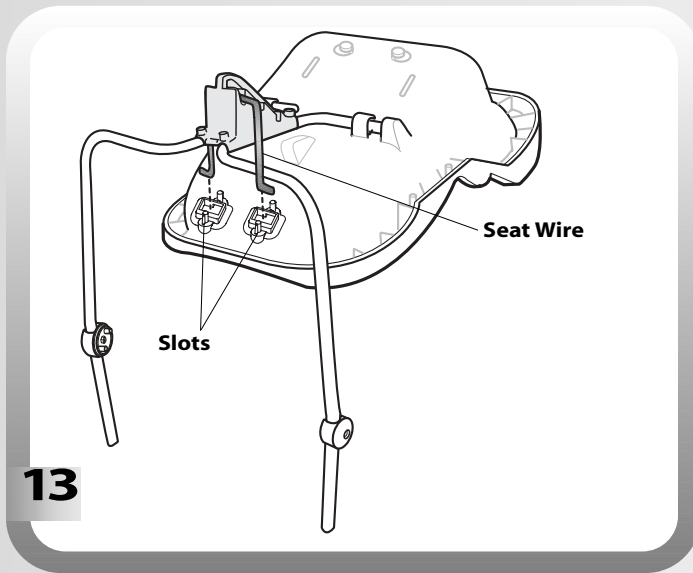

**13**

- Lift the seat tubes slightly.
- With the seat wire hanging down, insert the ends of the seat wire through the slots in the seat, as shown.

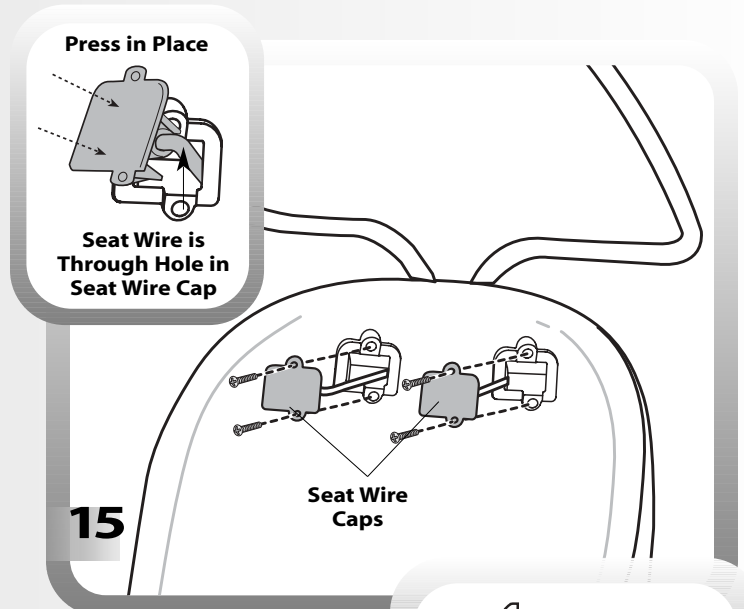

**15**

- Press the seat wire caps into place.
- Insert two #6 x 5/8" screws through each seat wire cap and tighten.



**#6 x 5/8" Screw - 4 Shown Actual Size**

***Hint:** The seat wire caps are designed to fit into the seat only one way. If the screw holes in the seat wire caps do not align with the holes in the seat, try switching the seat wire caps onto the opposite ends of the seat wire.*

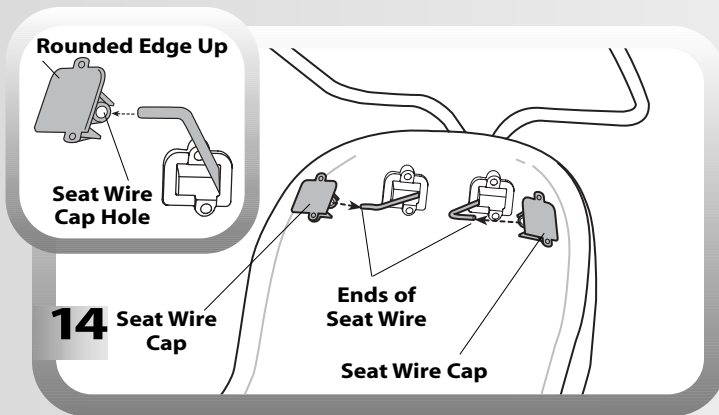

**14**

- While holding the seat wire in place, carefully turn the seat around so that the front faces you.
- Position the seat wire cap so that the rounded edge is upright.
- Fit each end of the seat wire through the hole in each seat wire cap.

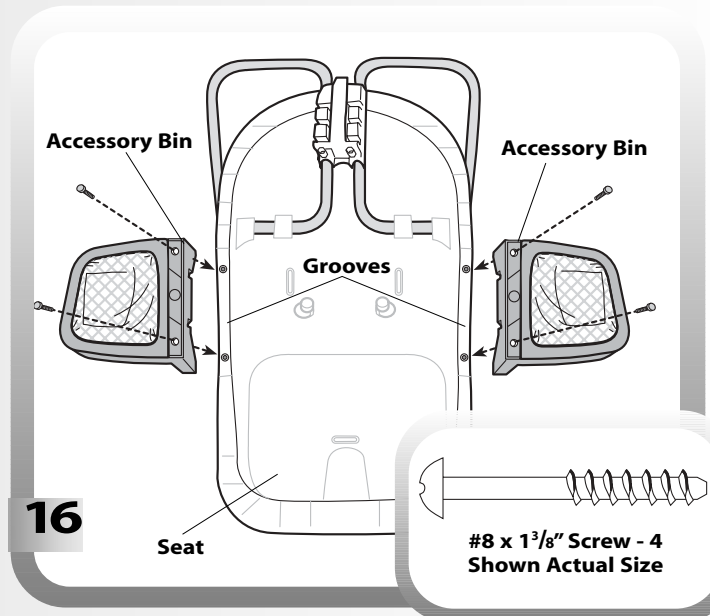

**16**

- Turn the seat face down.
- Fit an accessory bin into the groove on each side of the seat, as shown.
- Insert two #8 x 1 3/8" screws into each accessory bin and tighten.

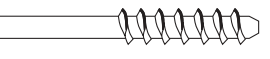

**#8 x 1 3/8" Screw - 4 Shown Actual Size**

# Assembly

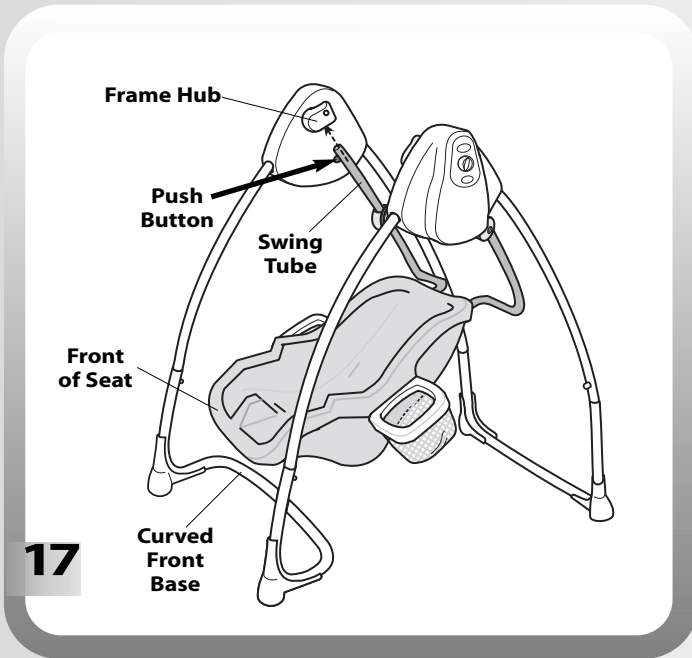

- Position the seat assembly so that the front of the seat is toward the curved front base.
- While pressing the buttons on the swing tubes, insert them into the frame hubs. Push the swing tubes up until the buttons “snap” into the hole in the frame hubs.
- Push down on the seat to be sure the seat is secured in both frame hubs.

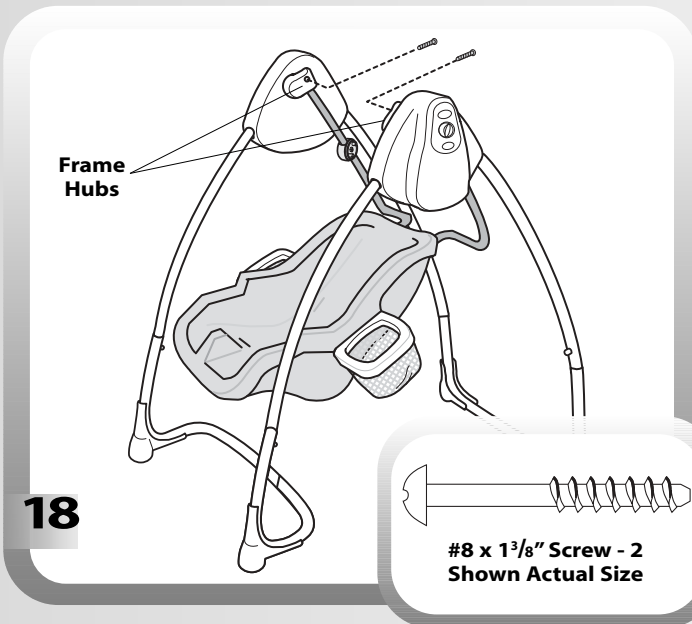

- Insert a #8 x 1 3/8" screw into each frame hub and tighten.
- Again, push down on the seat to be sure the seat is secured to both frame hubs.

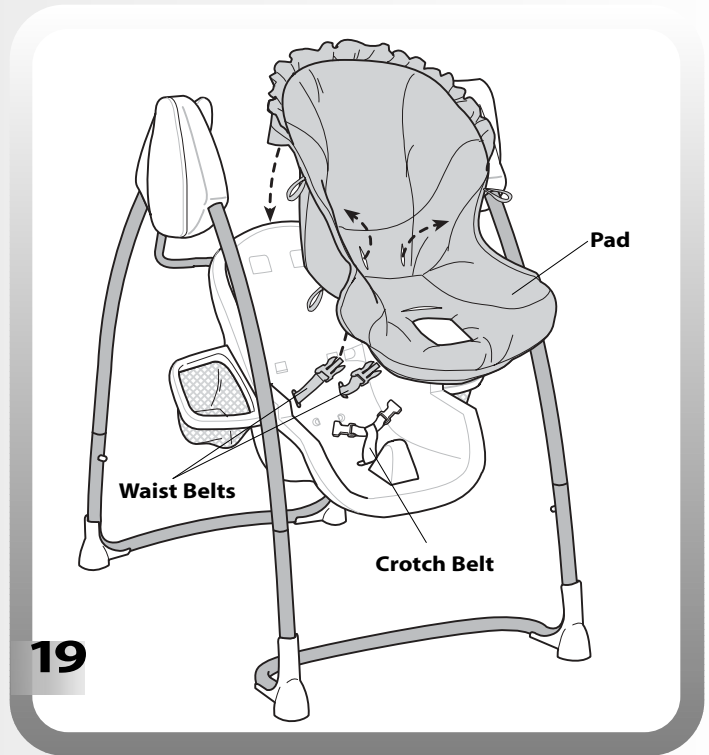

- Fit the pocket on the back of the pad onto the seat back.
- Fit the waist belts through the smaller slots in the pad.

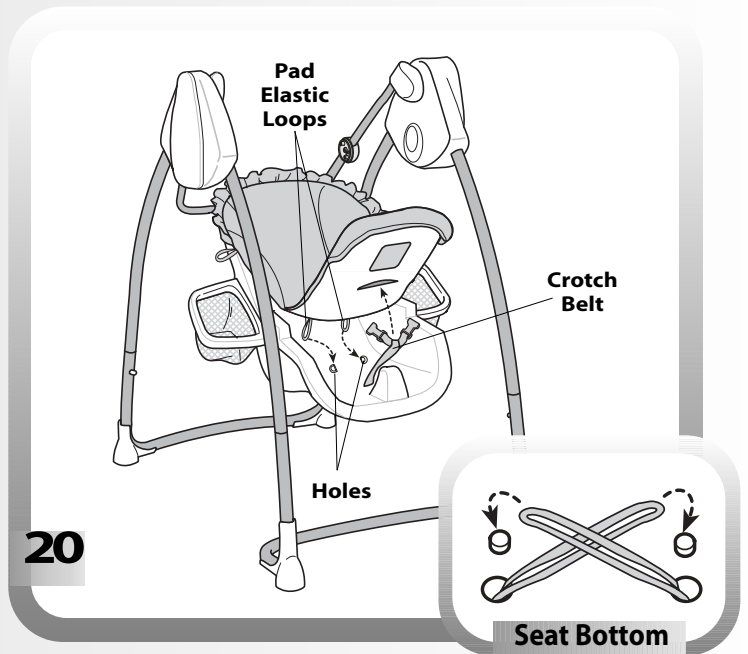

- Lift the bottom of the pad.
- Insert the pad elastic loops through the holes in the seat bottom.
- Insert the crotch belt through the slot in the pad.
- From under the seat, fit the elastic loops onto the tabs on the seat bottom.



# Assembly

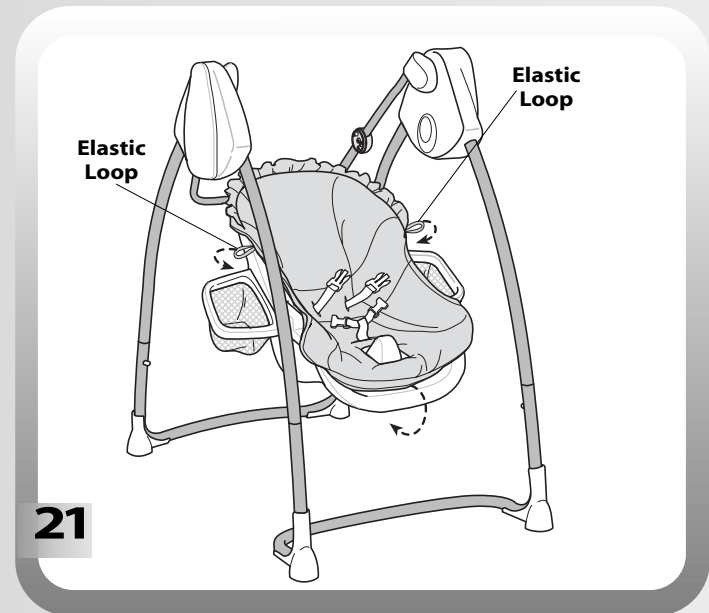

- Fit the bottom edge of the pad around the bottom edge of the seat.
- Hook the elastic loops on each side of the pad to the peg on the back of the accessory bins.

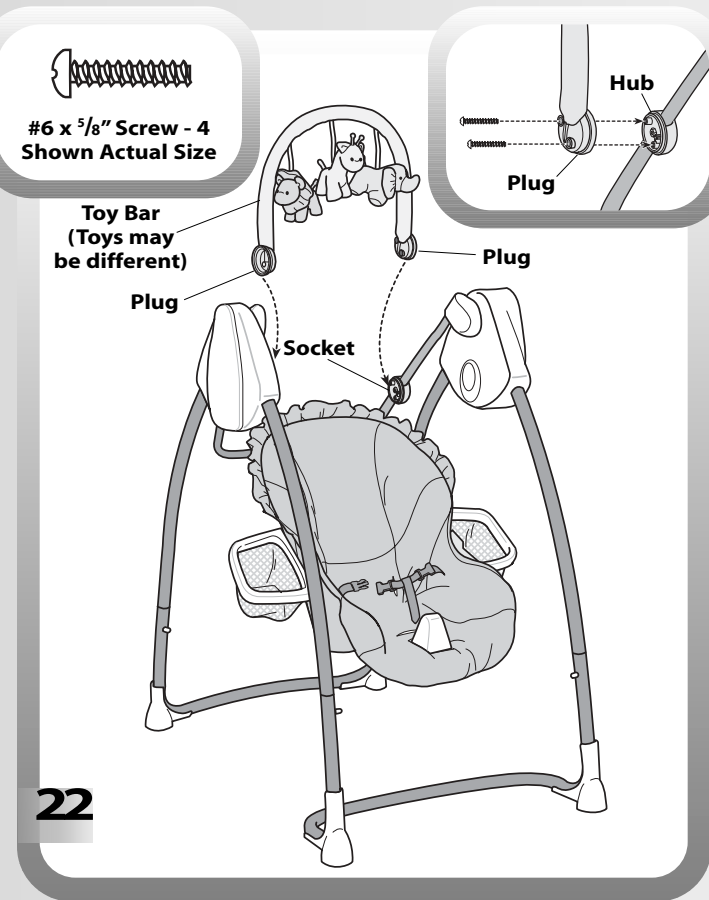

- Fit the toy bar plugs into the sockets on the swing tubes.

**Hint:** If the toy bar plugs do not fit into the sockets, turn the toy bar around. Now, fit the plugs into the sockets.

- Insert two #6 x 5/8" screws into each plug and tighten.

# Battery Installation

**Hint:** When swinging, sound or power L.E.D. slows/dims/stops, it's time to replace the batteries! We recommend using **alkaline** batteries for longer battery life.

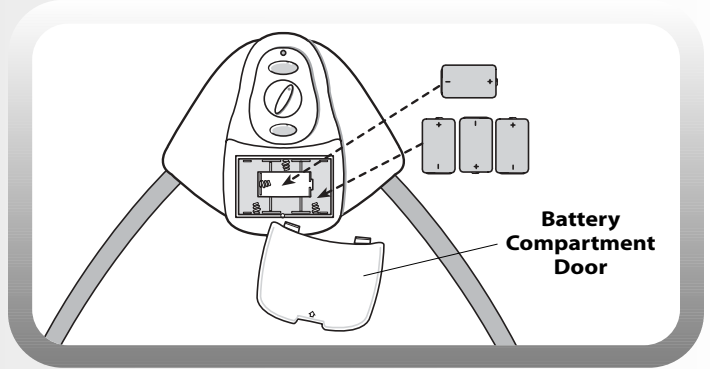

## Installation

- Locate the battery compartment door on the swing frame.
- Insert a coin into the battery compartment door and pry the battery compartment door off of the swing frame.
- Insert four "D" (LR20) **alkaline** batteries.
- Replace the battery compartment door.

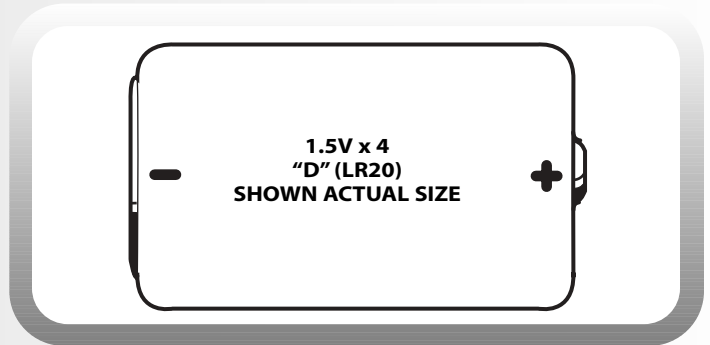

## Battery Safety Information

**Batteries may leak fluids that can cause a chemical burn injury or ruin your product. To avoid battery leakage:**

- Do not mix old and new batteries or batteries of different types: alkaline, standard (carbon-zinc) or rechargeable (nickel-cadmium).
- Insert batteries as indicated inside the battery compartment.
- Remove batteries during long periods of non-use. Always remove exhausted batteries from the product. Dispose of batteries safely. Do not dispose of batteries in a fire. The batteries may explode or leak.
- Never short-circuit the battery terminals.
- Use only batteries of the same or equivalent type, as recommended.
- Do not charge non-rechargeable batteries.
- Remove rechargeable batteries from the product before charging.
- If removable, rechargeable batteries are used, they are only to be charged under adult supervision.

# Securing Your Child

**IMPORTANT!** Before each use, inspect this product for damaged hardware, loose joints, missing parts or sharp edges. DO NOT use if any parts are missing or broken. Contact Fisher-Price® for replacement parts and instructions if needed. Never substitute parts.

## **WARNING**

- To prevent serious injury or death from falls and being strangled in the restraint system:
  - Always use the restraint system. Never rely on the tray to restrain child.
  - Never use with an active child who may be able to climb out of the seat.
- Never leave child unattended.

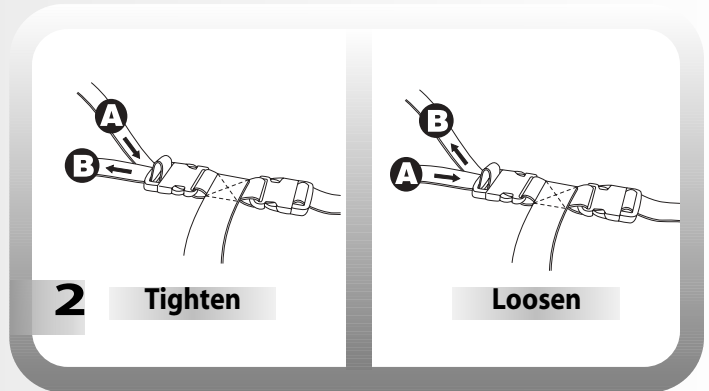

### To tighten the restraint:

- Feed the anchored end of the waist belt up through the buckle to form a loop **A**. Pull the free end of the waist belt **B**.

### To loosen the restraint:

- Feed the free end of the waist belt up through the buckle to form a loop **A**. Enlarge the loop by pulling on the end of the loop toward the buckle. Pull the anchored end of the waist belt to shorten the free end of the waist belt **B**.

**Note:** After adjusting the restraint to fit your child, make sure you pull on it to be sure it is securely fastened.

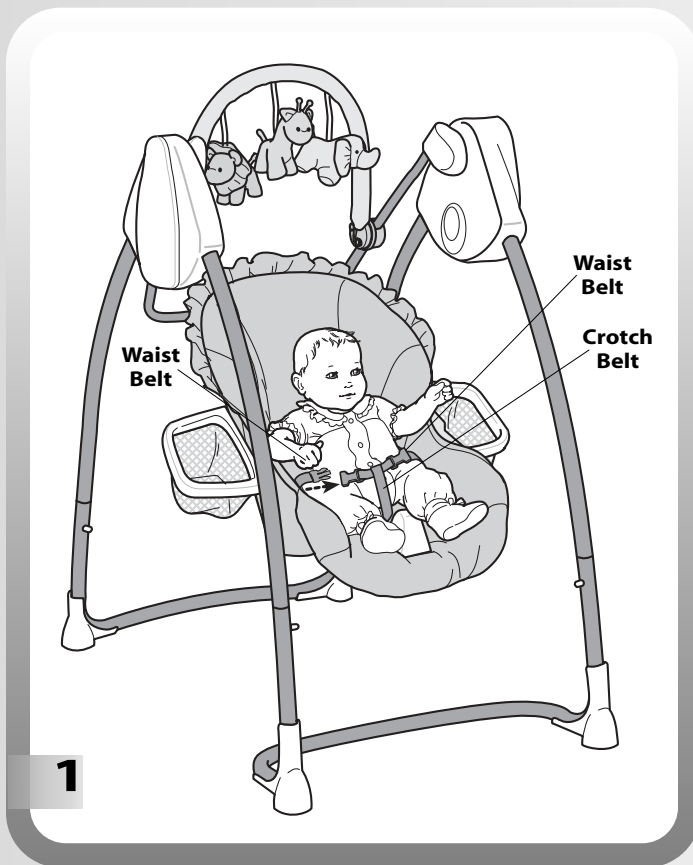

- Place your child in the seat. Position the crotch belt between your child's legs.
- Fasten both waist belts to each side of the crotch belt. Make sure you hear a "click" on both sides.
- Check to be sure the restraint system is securely attached by pulling it away from your child. The restraint system should remain attached.

## Adjusting the Seat

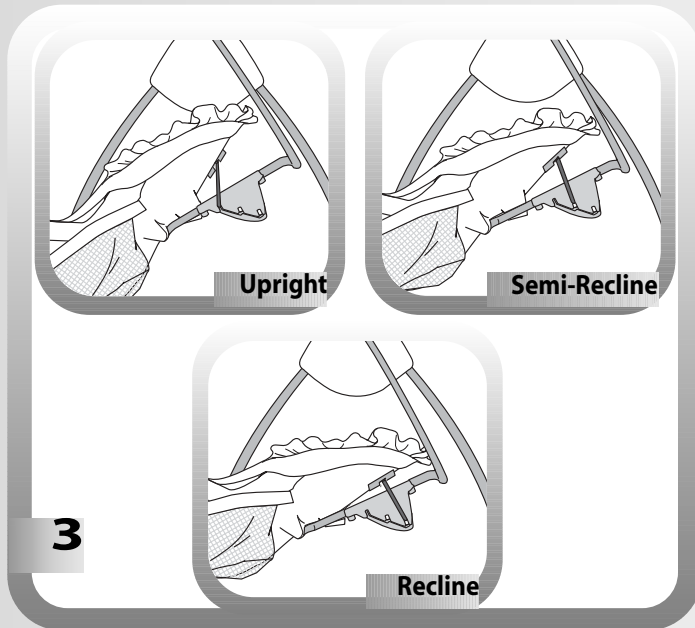

Adjust the seat angle in any of three positions: **Upright**, **Semi-Recline** or **Recline**.

**To adjust the seat angle:** Push down on the seat back to position the seat wire in the desired groove in the bracket for Upright, Semi-Recline or Recline.

## Using the Toy Bar

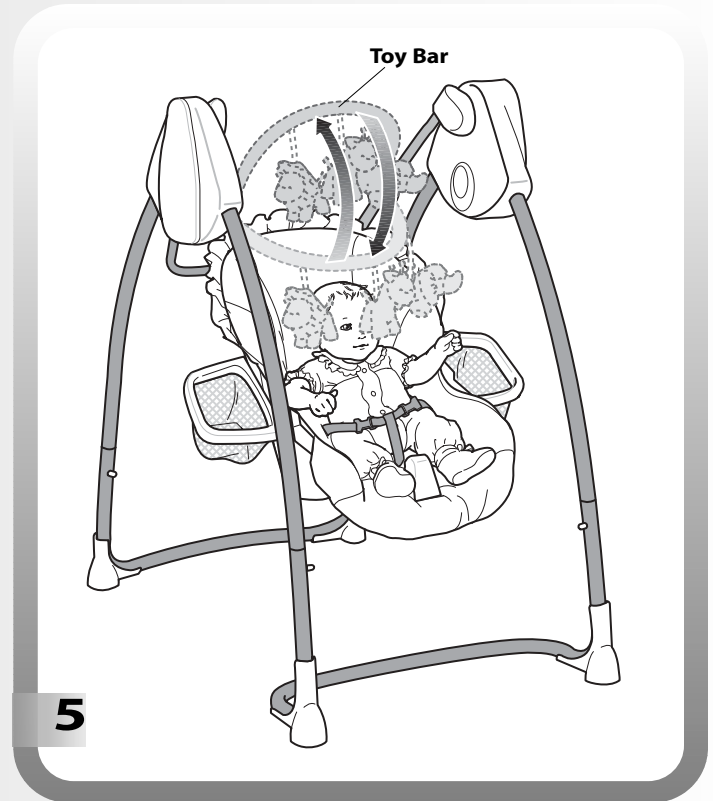

- Lift or lower the toy bar for baby's enjoyment.

## Using the Tray



- Fit the tray onto the seat armrests.

# Swing Modes

The Smart Response™ Swing has two modes: **Baby Sounds Activated**  and **Parent Activated** .

Product features and decorations may vary from pictures below.  
Accessories sold separately.



**IMPORTANT!** The maximum weight limit for this product is 24 lbs. If your child weighs less than 24 lbs., but is really active and appears to be able to climb out of the swing, immediately discontinue its use.

# Baby Sounds Activated

Product features and decorations may vary from picture below.  
Accessories sold separately.

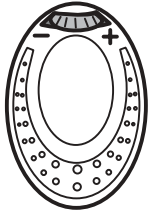

Sound Sensitivity Dial

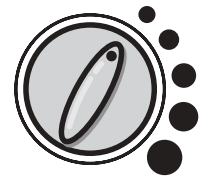

Speed Dial

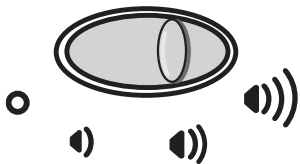

Music/Volume Switch

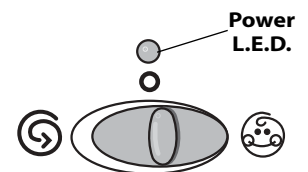





Swing Mode Switch

## Sound Sensitivity Dial

- Slide the switch to **+** **high sensitivity** for incoming sounds (listens for shallow sounds).
- Slide the switch to **-** **low sensitivity** for incoming sounds (listens only for loud sounds).

**Hint:** You may want to start with the high sensitivity setting **+** at first.

## Music/Volume Switch





- Select  for music highest volume.
- Select  for music high volume.
- Select  for music low volume.
- Select  to turn music off.

## Speed Dial

- Select any of five speed settings.

**Hint:** As with most battery-powered swings, a heavier child will reduce the amount of swinging motion on all settings. In most cases, the low setting works best for a smaller child while the high setting works best for a larger child.

## Swing Mode Switch

- Slide the switch to  **baby sounds activated**. The power L.E.D. lights. The swing begins swinging for about 15-20 minutes and if you have selected music, five songs play (about 15-20 minutes). After swinging (and music) stop, the swing is ready to listen for your baby's sounds for about two hours.
- When baby cries, the swing (and music, if selected) automatically turns on to soothe baby.
- If the swing is not activated (from baby's sounds) within two hours of selection, the power L.E.D. flashes to tell you that it going to turn off. Once it has turned off (and the power L.E.D. is not lit), you will need to slide the switch to the off position  and back to  baby sounds activated. The swing is now re-set to listen for your baby's sounds for another two hours.
- Be sure to turn the product off  when not in use.

# Parent Activated

Product features and decorations may vary from picture below.  
Accessories sold separately.

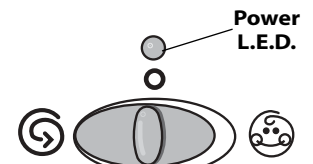

Swing Mode Switch

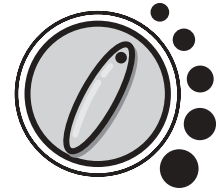

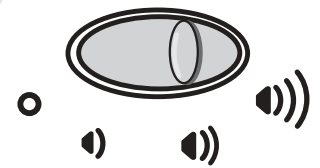

Speed Dial



Music/Volume Switch





## Swing Mode Switch

- Slide the switch to  **parent activated**. The power L.E.D. lights and the swing begins swinging.
- Be sure to turn the product off  when not in use.

## Speed Dial

- Select any of five speed settings.

## Music/Volume Switch

- Select  for music highest volume.
- Select  for music high volume.
- Select  for music low volume.
- Select  to turn music off.

**Hint:** As with most battery-powered swings, a heavier child will reduce the amount of swinging motion on all settings. In most cases, the low setting works best for a smaller child while the high setting works best for a larger child.

## Storage

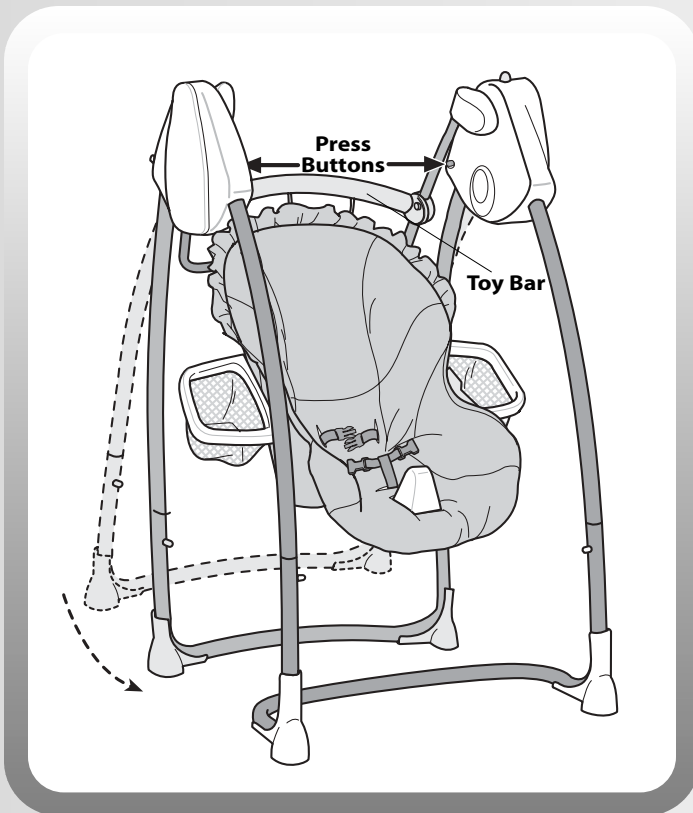

- Turn the toy bar back to its storage position.
- Press the button on the inside of each housing and push the rear legs toward the front legs. Stand the frame against a wall for storage.

## Care

The pad is machine washable. Wash the pad separately in cold water on the gentle cycle. Do not use bleach. Tumble dry separately on low heat and remove promptly. The frame, tray, and toybar may be wiped clean using a mild cleaning solution and a damp cloth.

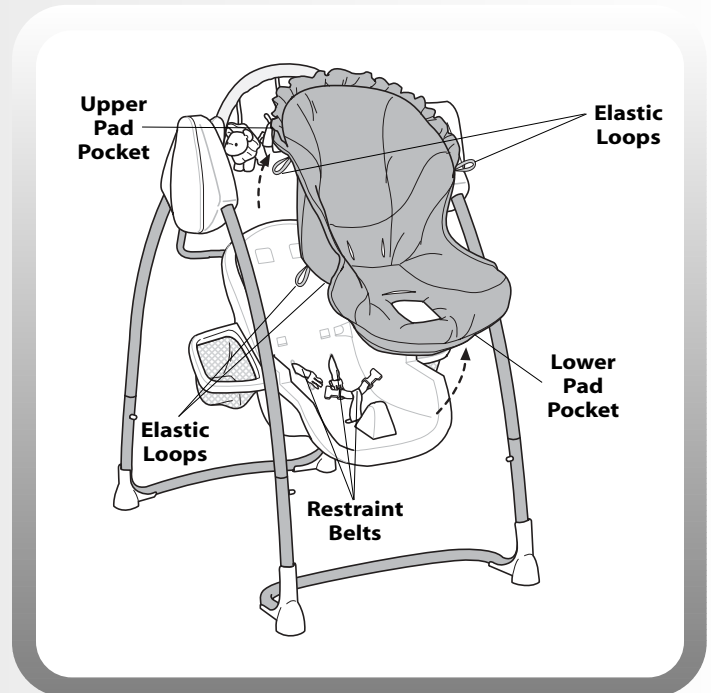

### To remove the pad:

- Unhook the four elastic hooks from the pegs on the seat back and bottom.
- Push the restraint belts back through the slots in the pad.
- Slide the upper pad pocket off of the seat back.
- Slide the lower pad pocket off of the seat bottom.

### To replace the pad:

- Refer to Assembly steps 19 - 21.

**Note:** This product has no consumer serviceable parts. Do not take this product apart.

## One (1) Year Limited Warranty

Fisher-Price, Inc., 636 Girard Avenue, East Aurora, New York 14052 warrants that Smart Response™ Swing is free from all defects in material and workmanship when used under normal conditions for a period of one (1) year from the date of purchase.

Should the product fail to perform properly, we will repair or replace it at our option, free of charge. Purchaser is responsible for shipping the product to Consumer Relations at the address indicated above and for all associated freight and insurance cost. Fisher-Price, Inc. will bear the cost of shipping the repaired or replaced item to you. This warranty is void if the owner repairs or modifies the product. This warranty excludes any liability other than that expressly stated above including but not limited to any incidental or consequential damages.

SOME STATES DO NOT ALLOW THE EXCLUSION OR LIMITATION OF INCIDENTAL OR CONSEQUENTIAL DAMAGES, SO THE ABOVE LIMITATION OR EXCLUSION MAY NOT APPLY TO YOU.

THIS WARRANTY GIVES YOU SPECIFIC LEGAL RIGHTS, AND YOU MAY ALSO HAVE OTHER RIGHTS WHICH MAY VARY FROM STATE TO STATE.

## FCC Statement (United States Only)

This equipment has been tested and found to comply with the limits for a Class B digital device, pursuant to part 15 of the FCC rules. These limits are designed to provide reasonable protection against harmful interference in a residential installation. This equipment generates, uses and can radiate radio frequency energy and, if not installed and used in accordance with the instructions, may cause harmful interference to radio communications. However, there is no guarantee that interference will not occur in a particular installation. If this equipment does cause harmful interference to radio or television reception, which can be determined by turning the equipment off and on, the user is encouraged to try to correct the interference by one or more of the following measures:

Reorient or relocate the receiving antenna.

Increase the separation between the equipment and receiver.

Connect the equipment into an outlet on a circuit different from that to which the receiver is connected.

Consult the dealer or an experienced radio/TV technician for help.

Note: Changes or modifications not expressly approved by the manufacturer responsible for compliance could void the user's authority to operate the equipment.

### For other countries outside the United States:

Canada: call 1-800-567-7724, or write to: Mattel Canada Inc., 6155 Freemont Blvd., Mississauga, Ontario L5R 3W2.

Great Britain: telephone 01628 500302.

Australia: Mattel Australia Pty. Ltd., 658 Church Street, Locked Bag #870, Richmond, Victoria 3121 Australia. Consumer Advisory Service 1300 135 312.

New Zealand: 16-18 William Pickering Drive, Albany 1331, Auckland.

Asia: Mattel East Asia Ltd, Room 1106, South Tower, World Finance Centre, Harbour City, Tsimshatsui, HK, China.