

Fisher-Price®

Deluxe Take-Along™ Swing



Model Number: 79618

Please keep this instruction sheet, as it contains important information.

Adult assembly is required.

Tool needed for battery installation: Phillips Screwdriver.

Requires four "C" (LR14) **alkaline** batteries for operation (not included).

Weight Limit: 17 lbs (7.7 kg).

IMPORTANT! The maximum weight limit for this product is 17 lbs. If your child weighs less than 17 lbs., but is really active and appears to be able to climb out of the swing, immediately discontinue its use.

www.fisher-price.com

Warnings



WARNING

- To prevent falls:
 - Never use with an active child who may be able to climb out.
 - Never use on any elevated surface.
- To prevent injury or death from falls or sliding out, always use restraint system.
- Never leave child unattended.

Consumer Information

Occasionally a consumer may experience a problem with one of our products. If this should happen, please call us toll-free, rather than return this product to the store. Usually, we can solve the problem over the telephone or send you replacement parts.

Please call Fisher-Price® Consumer Relations, toll-free at **1-800-432-KIDS**, 8 AM - 6 PM EST Monday through Friday. Hearing-impaired consumers using TTY/TDD equipment, please call 1-800-382-7470.

Or, write to:
Fisher-Price® Consumer Relations
636 Girard Avenue
East Aurora, New York 14052

Parts

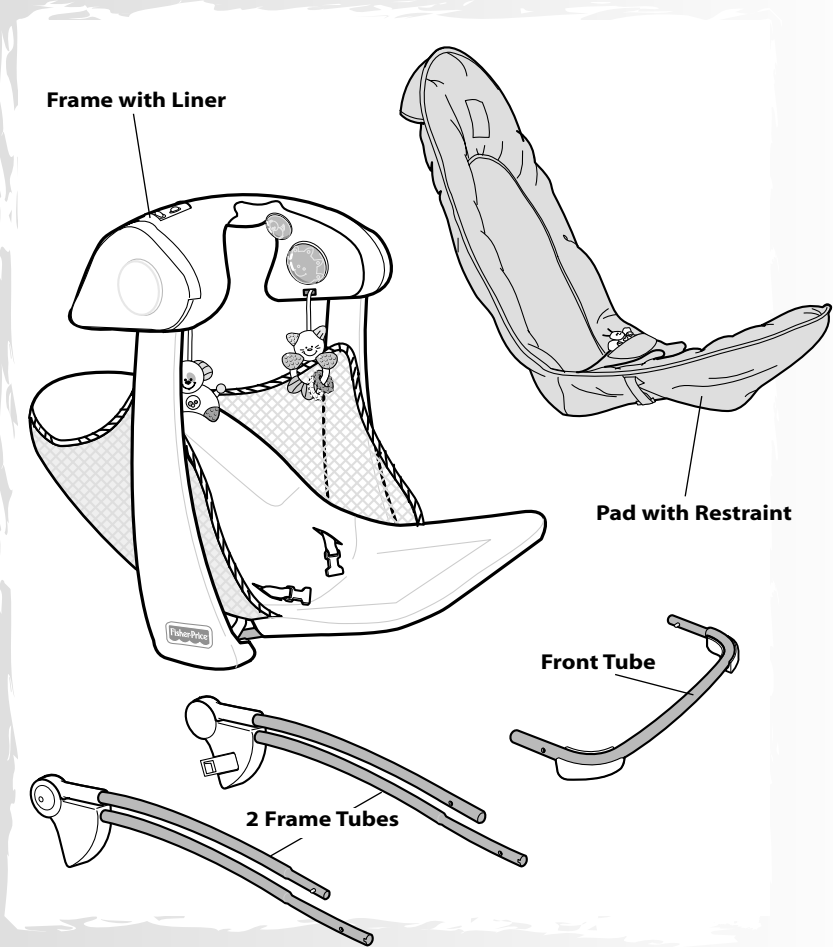

Assembly

IMPORTANT! Before assembly, inspect this product for damaged hardware, loose joints, missing parts or sharp edges. DO NOT use if any parts are missing or broken. Contact Fisher-Price® for replacement parts and instructions if needed. Never substitute parts.

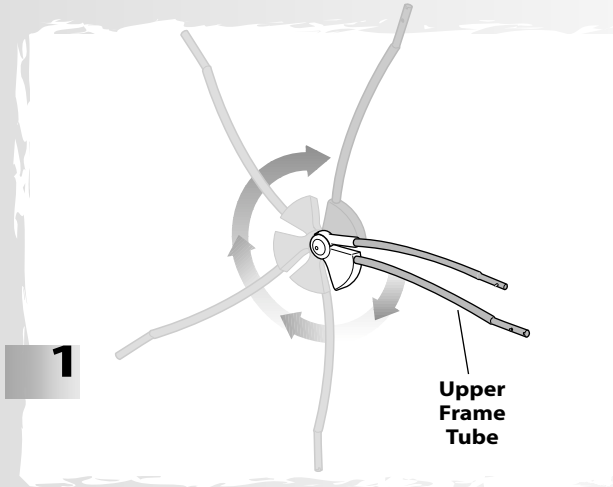

- Rotate the upper frame tube until it **"snaps"** into an upright position, as shown.

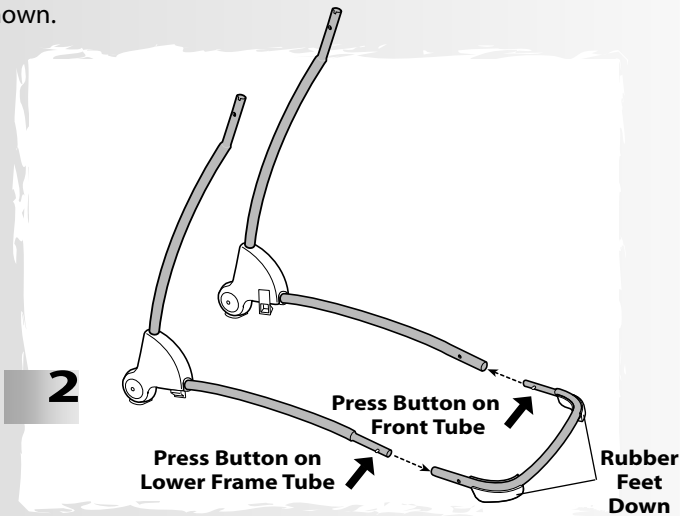

- Position the front tube so that the rubber feet are **flat** on the surface.
- While pressing the button on the lower frame tube, insert it into an end of the front tube. Continue to insert the lower frame tube into the front tube until you **hear a "click"**.
- While pressing the button on the front tube, insert it into the end of the lower frame tube. Continue to insert the front tube into the lower frame tube until you **hear a "click"**.

Assembly

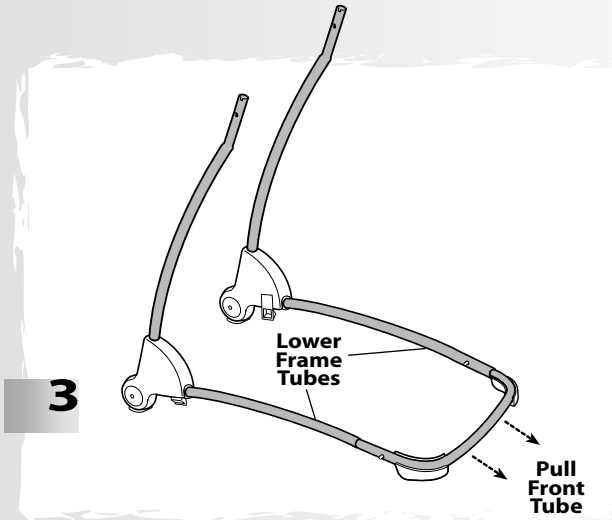

- Pull the front tube to be sure it is secure to each lower frame tube.

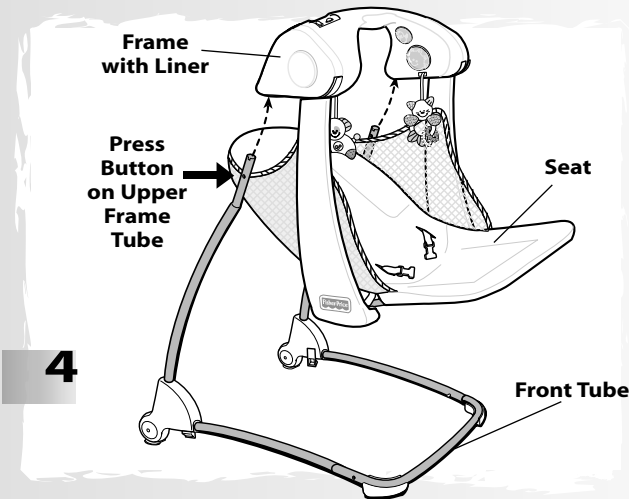

- Position the frame with liner so that the seat is over the front tube.
- While pressing the buttons on the upper frame tubes, insert them into the holes in the underside of the frame with liner.
- Continue to insert the upper frame tubes into the frame with liner until you hear a **"click"** on both sides.

Assembly

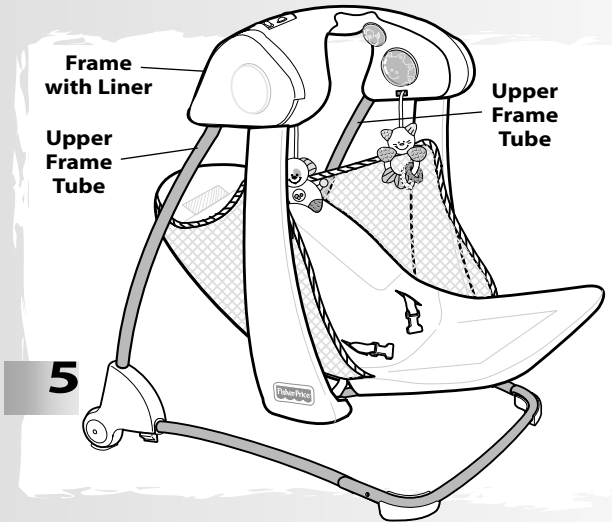

- Check to be sure the upper frame tubes are secure in the frame with liner. If you can remove the upper frame tubes from the frame with liner, you have not properly inserted the tubes into the frame. Remove the upper frame tubes from the frame with liner and repeat Assembly step 4.

IMPORTANT! Attach the provided pad (with restraint system) to this product. Never use this product without the provided pad.

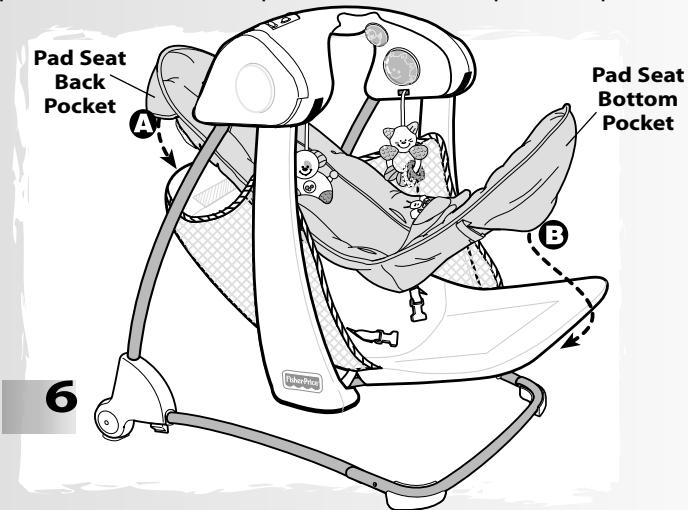

- Fit the pad seat back pocket over the seat back **A** and fasten.
- Fit the pad seat bottom pocket over the seat bottom and fasten **B**.

Assembly

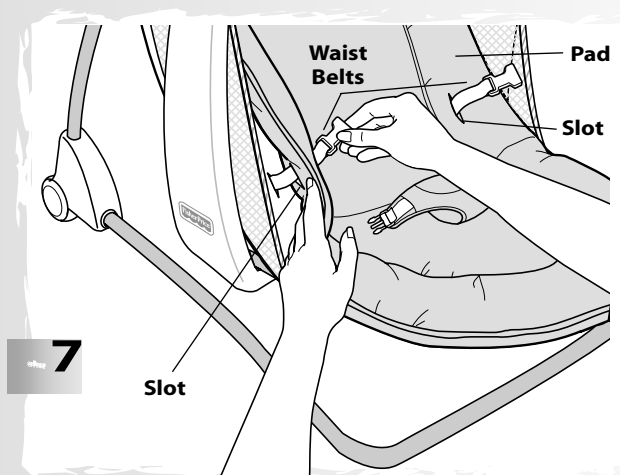

- Pull the edges of the pad up slightly and insert the waist belts on the liner through the slots in the pad.

Assembly is now complete.

Battery Installation

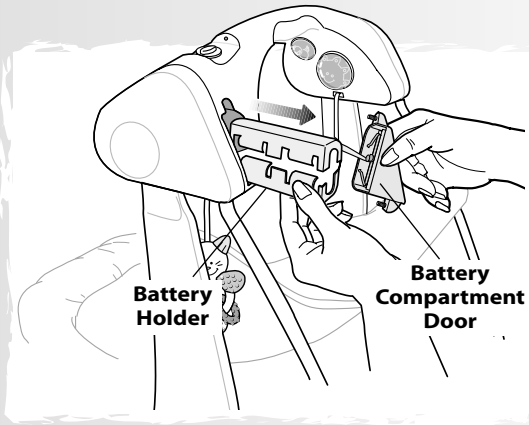

- Locate the battery compartment door on the frame.
- Loosen the screw in the battery compartment door with a Phillips screwdriver.
- Remove the battery compartment door and the battery holder from the battery compartment.

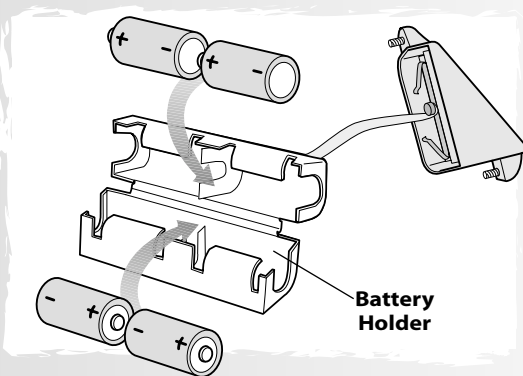

- Open the battery holder.
- Insert four "C" (LR14) **alkaline** batteries as indicated inside the battery holder.

Hint: We recommend using **alkaline** batteries for longer battery life.

- Close the battery holder.

Battery Installation

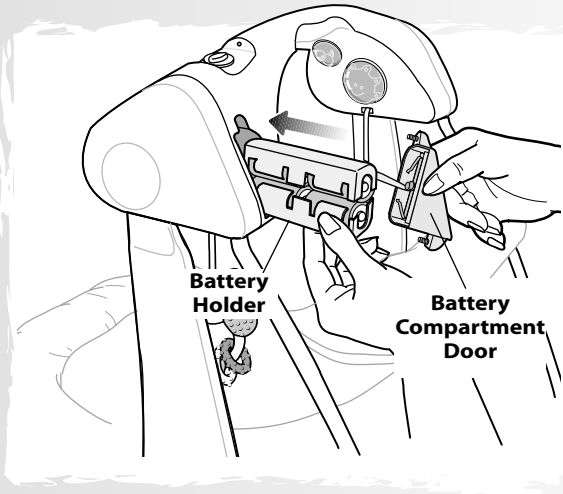

- Align the ridge on the battery holder with the groove in the battery compartment.
- Slide the battery holder back into the battery compartment.
- Replace the battery compartment door and tighten the screw with a Phillips screwdriver. Do not over-tighten.

Battery Tips

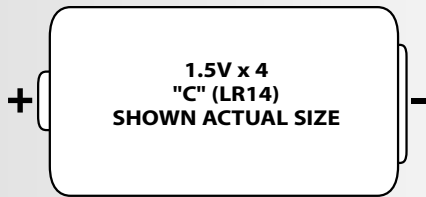

- Do not mix old and new batteries.
- Do not mix different types of batteries: alkaline, standard (carbon-zinc) or rechargeable (nickel-cadmium).
- Remove the batteries during long periods of non-use. Always remove exhausted batteries from the toy. Battery leakage and corrosion can damage this toy. Dispose of batteries safely.
- Do not dispose of batteries in a fire. The batteries may explode or leak.
- Never short circuit the battery terminals.
- Non-rechargeable batteries are not to be recharged.
- Only batteries of the same or equivalent type as recommended in the "Battery Installation" instructions are to be used.
- If removable rechargeable batteries are used, they are only to be charged under adult supervision.
- Rechargeable batteries are to be removed from the toy before they are charged.
- If you use a battery charger, it should be examined regularly for damage to the cord, plug, enclosure and other parts. Do not use a damaged battery charger until it has been properly repaired.

Securing Your Child



WARNING

- To prevent falls:
 - Never use with an active child who may be able to climb out.
 - Never use on any elevated surface.
- To prevent injury or death from falls or sliding out, always use restraint system.
- Never leave child unattended.

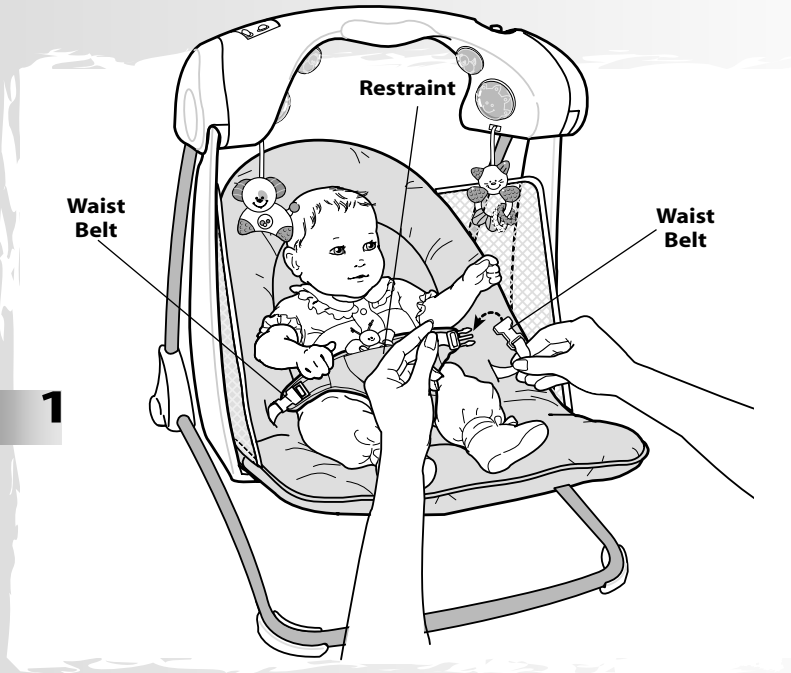

- Place your child in the seat. Position the restraint between your child's legs.
- Fasten both waist belts to each side of the restraint. **Make sure you hear a "click" on each side.**
- Check to be sure the restraint is securely attached by pulling it away from your child. The restraint should remain attached.

Securing Your Child

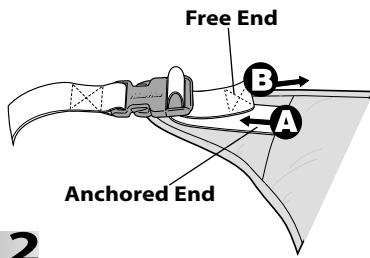

2

Tighten

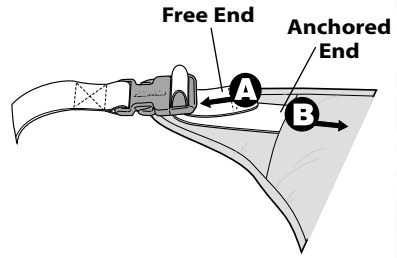

Loosen

To tighten the restraint:

- Feed the anchored end of the restraint belt up through the buckle to form a loop **A**.
- Pull the free end of the restraint belt **B**.
- Repeat this procedure to tighten the other restraint belt.

To loosen the restraint:

- Feed the free end of the restraint strap up through the buckle to form a loop **A**.
- Enlarge the loop by pulling on the end of the loop toward the buckle.
- Pull the anchored end of the restraint belt to shorten the free end of the restraint belt **B**.
- Repeat this procedure to loosen the other restraint belt.

Note: After adjusting the restraint to fit your child, make sure you pull on it to be sure it is securely fastened.

Starting the Swing

IMPORTANT! Before each use, inspect this product for damaged hardware, loose joints, missing parts or sharp edges. DO NOT use if any parts are missing or broken. Contact Fisher-Price® for replacement parts and instructions if needed. Never substitute parts.



- Turn the power dial to any of eight settings.
- Give the seat a light push to start the swinging motion. Adjust the swing power dial to the desired swing motion setting.

Hint: As with most battery-powered swings, a heavier child will reduce the amount of swinging motion on all settings. In most cases, the low setting works best for a smaller child while the high setting works best for a larger child.

- If swinging stops while using a lower setting, try a higher setting. Give the seat a light push to start the swinging motion again.
- Be sure to turn this product off when not in use. Turn the power dial to the off setting ○.

Lights and Music!

Hint: Your baby can enjoy lights and music **with** or **without** swinging.

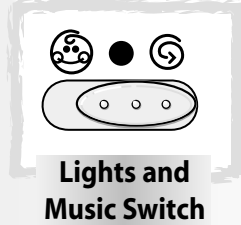
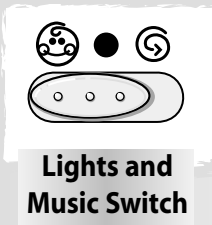

- Slide the lights and music switch to: **baby activated lights and one song** (baby icon); **sound and lights off** (black dot); or **parent activated lights and music** (parent icon).



When baby pulls either toy on the arch, one tune plays along with twinkling lights.



On this setting, six tunes (approximately 10 minutes) play along with dancing lights.



Turns lights and music off.

- Turn the volume dial to a comfortable listening level.

IMPORTANT! The maximum weight limit for this product is 17 lbs. If your child weighs less than 17 lbs., but is really active and appears to be able to climb out of the swing, immediately discontinue its use.

Room-to-Room Portability



WARNING

- To prevent falls: Never use on any elevated surface.
- To prevent injury or death from falls or sliding out, always use restraint system.



- Make sure your child is properly secured in the swing seat.
- With baby facing forward and outward, lift the swing using the handle.
- Carefully carry the swing to another room. Be sure to set the swing down on a **non-elevated, flat surface.**

Take-Along

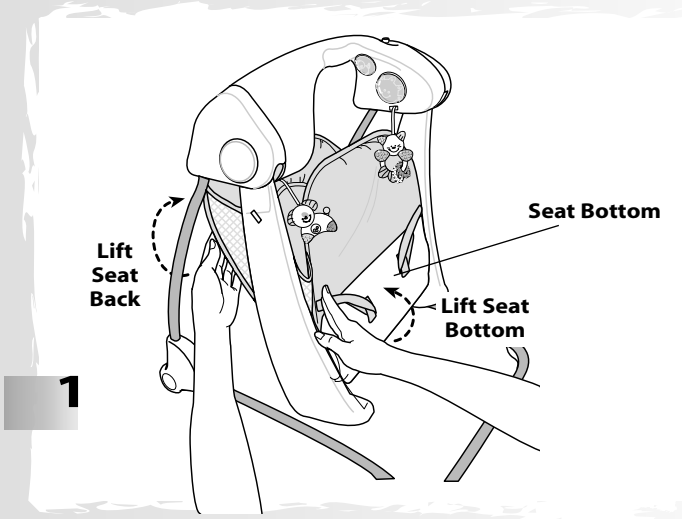

- Lift the seat back and seat bottom together.

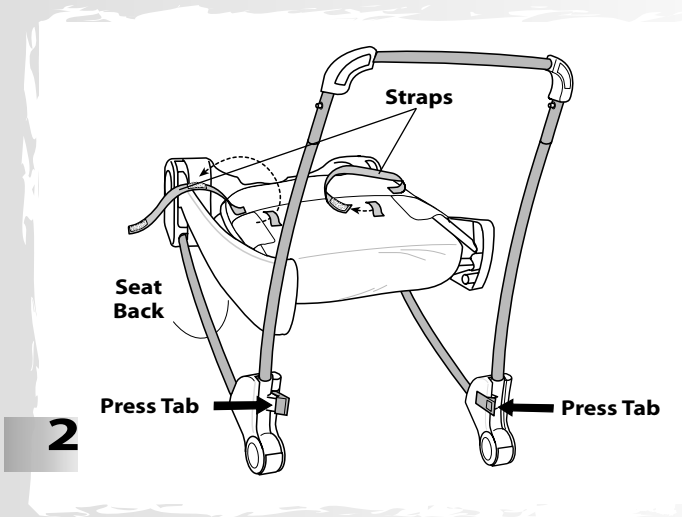

- Tip the swing backwards the seat back down.
- Unfasten the straps on the seat bottom.
- Pull the straps from the loops on the seat bottom.
- Press both tabs on the frame **at the same time** to release the frame base.

Take-Along

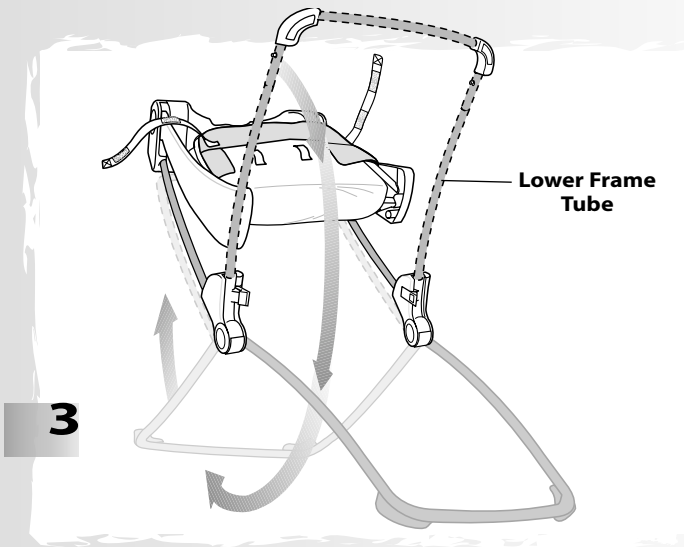

- Rotate the lower frame tube around to the top of frame, as shown.

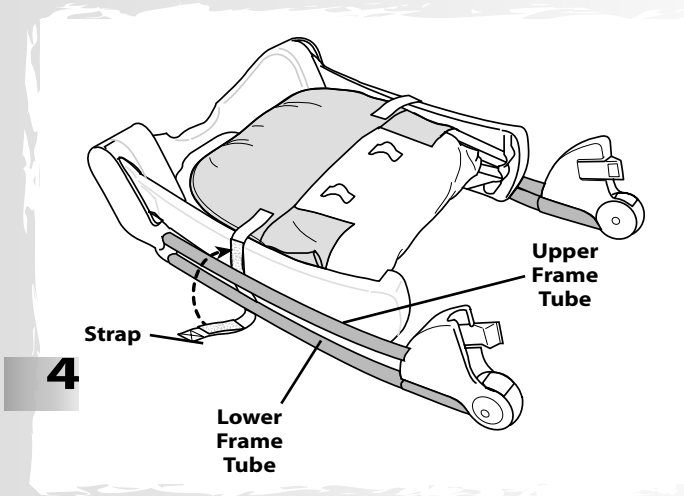

- Fit the straps on the seat bottom between the upper and lower frame tubes, as shown.
- Wrap the straps around the lower frame tubes and fasten the straps.

To set the swing back up for use:

- Unfasten the straps around the upper and lower frame tubes.
- Replace the straps through the loops on the seat bottom and fasten.
- Rotate the lower frame tube around until it snaps into place.
- Place the swing on a **non-elevated, flat surface**.

Care

- The pad is machine washable. Wash the pad separately in cold water on the gentle cycle. Do not use bleach. Tumble dry separately on low heat and remove promptly. The frame, liner and toys may be wiped clean using a mild cleaning solution and a damp cloth. Do not immerse the frame.
- This product has no consumer serviceable parts. Do not take this product apart.

IMPORTANT! Never use this product without the provided pad. Be sure to re-attach the provided pad (with restraint system) to this product.

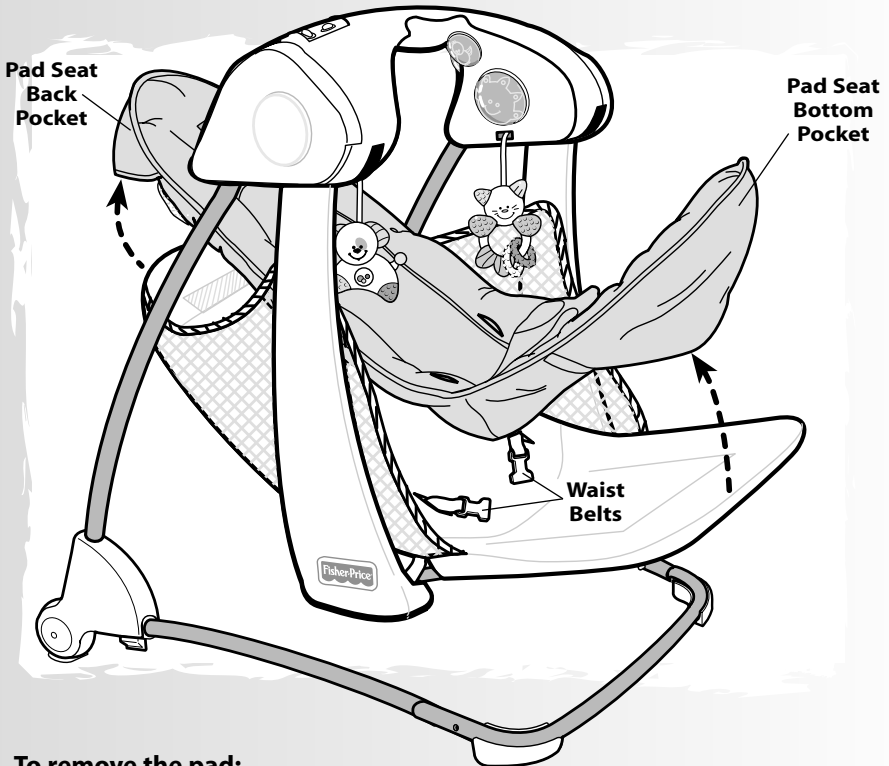

To remove the pad:

- Push the waist belts back through the slots in the pad.
- Unfasten and slide the pad seat back pocket off of the seat back.
- Unfasten and slide the pad seat bottom pocket off of the seat bottom.

To replace the pad:

- Refer to Assembly steps 6 and 7.

One (1) Year Limited Warranty

Fisher-Price, Inc., 636 Girard Avenue, East Aurora, New York 14052 warrants that the Deluxe Take-Along Swing is free from all defects in material and workmanship when used under normal conditions for a period of one (1) year from the date of purchase.

Should the product fail to perform properly, we will repair or replace it at our option, free of charge. Purchaser is responsible for shipping the product to Consumer Relations at the address indicated above and for all associated freight and insurance cost. Fisher-Price, Inc. will bear the cost of shipping the repaired or replaced item to you. This warranty is void if the owner repairs or modifies the product. This warranty excludes any liability other than that expressly stated above including but not limited to any incidental or consequential damages.

SOME STATES DO NOT ALLOW THE EXCLUSION OR LIMITATION OF INCIDENTAL OR CONSEQUENTIAL DAMAGES, SO THE ABOVE LIMITATION OR EXCLUSION MAY NOT APPLY TO YOU.

THIS WARRANTY GIVES YOU SPECIFIC LEGAL RIGHTS, AND YOU MAY ALSO HAVE OTHER RIGHTS WHICH MAY VARY FROM STATE TO STATE.

FCC Statement (United States Only)

This equipment has been tested and found to comply with the limits for a Class B digital device, pursuant to part 15 of the FCC rules. These limits are designed to provide reasonable protection against harmful interference in a residential installation. This equipment generates, uses and can radiate radio frequency energy and, if not installed and used in accordance with the instructions, may cause harmful interference to radio communications. However, there is no guarantee that interference will not occur in a particular installation. If this equipment does cause harmful interference to radio or television reception, which can be determined by turning the equipment off and on, the user is encouraged to try to correct the interference by one or more of the following measures:

Reorient or relocate the receiving antenna.

Increase the separation between the equipment and receiver.

Connect the equipment into an outlet on a circuit different from that to which the receiver is connected.

Consult the dealer or an experienced radio/TV technician for help.

CAUTION: Changes or modifications not expressly approved by the manufacturer responsible for compliance could void the user's authority to operate the equipment.

For other countries, outside the United States:

Canada: call 1-800-567-7724, or write to:

Mattel Canada Inc, 6155 Freemont Blvd., Mississauga, Ontario L5R 3W2.

Great Britain: telephone 01628 500303.

Australia: Mattel Australia Pty. Ltd., 658 Church Street, Locked Bag #870, Richmond, Victoria 3121 Australia.

Consumer Advisory Service 1300 135 312.

New Zealand: 16-18 William Pickering Drive, Albany 1331, Auckland.