

DEWALT

INSTRUCTION MANUAL DW130 1/2" Drill

ial Tool Company, 626 Hanover Pike, P.O. Box 158, Hampstead, MD 21074 Printed in U.S.A. (MAY95-CD-6) Form No. 158673-02
or information call toll free between 8:00 a.m. and 8:00 p.m., seven days a week. 1-800-4-DeWALT (1-800-433-9258)

Copyright 1993, 1995

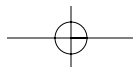

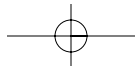

ANY QUESTIONS OR COMMENTS
 FOR ANY DEWALT TOOL, CALL US
 1-800-4-DEWALT (1-800-433-9258).

Nameplate	Date of Purchase
Information for future reference.	

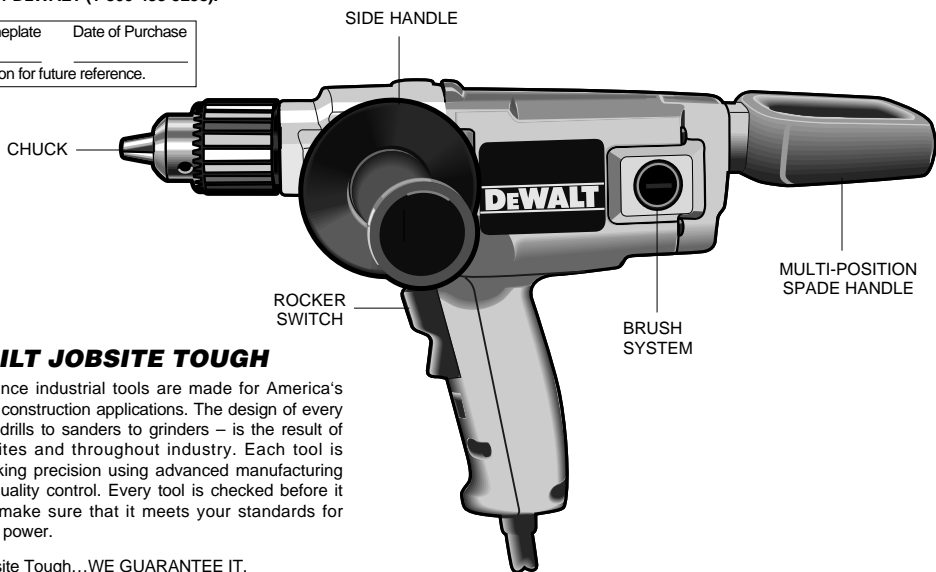

...BUILT JOBSITE TOUGH

Performance industrial tools are made for America's
 industrial and construction applications. The design of every
 tool from drills to sanders to grinders – is the result of
 precision engineering and throughout industry. Each tool is
 built with painstaking precision using advanced manufacturing
 processes and quality control. Every tool is checked before it
 leaves the factory to make sure that it meets your standards for
 performance and power.

That's Jobsite Tough...WE GUARANTEE IT.

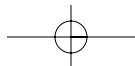

Important Safety Instructions

WARNING: When using electric tools, basic safety precautions should always be followed to reduce risk of fire, electric shock, and personal injury, including the following:

READ ALL INSTRUCTIONS

Double Insulation

Double insulated tools are constructed throughout with two separate layers of electrical insulation or one double thickness of insulation between you and the tool's electrical system. Tools built with this insulation system are not intended to be grounded. As a result, your tool is equipped with a two prong plug which permits you to use extension cords without concern for maintaining a ground connection.

NOTE: Double insulation does not take the place of normal safety precautions when operating this tool. The insulation system is for added protection against injury resulting from a possible electrical insulation failure within the tool.

CAUTION: WHEN SERVICING USE ONLY IDENTICAL REPLACEMENT PARTS. Repair or replace damaged cords.

Polarized Plugs

Polarized plugs (one blade is wider than the other) are used on equipment to reduce the risk of electric shock. When provided, this plug will fit in the polarized outlet only one way. If the plug does not fit fully into the outlet, reverse the plug. If it still does not fit, contact a qualified electrician to install the proper outlet. Do not change the plug in any way.

Safety Instructions For All Tools

- **KEEP WORK AREA CLEAN.** Cluttered workbenches invite injuries.
- **CONSIDER WORK AREA ENVIRONMENT.** Do not expose power tools to rain. Don't use power tools in wet locations. Keep work area well lit. Do not work in the presence of flammable liquids or gases.
- **GUARD AGAINST ELECTRIC SHOCK.** Prevent contact with grounded surfaces. For example, radiators, ranges, and refrigerator enclosures.
- **KEEP CHILDREN AWAY.** Do not let visitors connect or extension cord. All visitors should be kept away from work area.
- **STORE IDLE TOOLS.** When not in use, tools should be stored in dry, and high or locked-up place — out of children's reach.
- **DON'T FORCE TOOL.** It will do the job better and at the rate for which it was intended.
- **USE RIGHT TOOL.** Don't force small tool or attachment to do the job of a heavy-duty tool. Don't use tool for which it was not intended.
- **DRESS PROPERLY.** Do not wear loose clothing or jewelry. They can be caught in moving parts. Safety gloves and non-skid footwear are recommended when working outdoors. Wear protective hair covering to prevent long hair from being caught.
- **USE SAFETY GLASSES.** Also use face or dust mask when operation is dusty.
- **DON'T ABUSE CORD.** Never carry tool by cord or use cord to disconnect from receptacle. Keep cord from being caught in and sharp edges.

(Black plate)

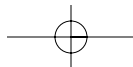

WORK. Use clamps or a vise to hold work. It's safer for your hand and it frees both hands to operate tool. **REACH.** Keep proper footing and balance at all

TOOLS WITH CARE. Keep tools sharp and clean for better performance. Follow instructions for lubricating accessories. Inspect tool cords periodically and if they are repaired by authorized service facility. Inspect tools periodically and replace if damaged. Keep clean, and free from oil and grease.

TURN OR LOCK OFF TOOLS when not in use, before changing accessories, such as blades, bits,

JUSTICE KEYS AND WRENCHES. Form habit of using keys and adjusting wrenches are removed before turning it on.

UNINTENTIONAL STARTING. Don't carry tool with your hand. Be sure switch is off when plugging in.

CORDS. Make sure your extension cord is in good condition when using an extension cord, be sure to use one rated to carry the current your product will draw. An undersized cord will cause a drop in line voltage resulting in loss of power and overheating. The following table shows the correct cord depending on cord length and nameplate ampere output, use the next heavier gage. The smaller the cord, the heavier the cord.

Rating Not more Than	Minimum Gage for Cord Sets			
	Total Length of Cord in Feet			
	0-25 0-50	26-50 51-100	51-100 101-200	101-150 201-300
6	18	16	16	14
10	18	16	14	12
12	16	16	14	12
16	14	12	Not Recommended	

- **OUTDOOR USE EXTENSION CORDS.** When tool is used outdoors, use only extension cords intended for use outdoors and so marked.
- **STAY ALERT.** Watch what you are doing. Use common sense. Do not operate tool when you are tired.
- **CHECK DAMAGED PARTS.** Before further use of the tool, a guard or other part that is damaged should be carefully checked to determine that it will operate properly and perform its intended function. Check for alignment of moving parts, binding of moving parts, breakage of parts, mounting, and any other conditions that may affect its operation. A guard or other part that is damaged should be properly repaired or replaced by an authorized service center unless otherwise indicated elsewhere in this instruction manual. Have defective switches replaced by authorized service center. Do not use tool if switch does not turn it on and off.
- **CAUTION:** When drilling or driving into walls, floors or wherever live electrical wires may be encountered, **DO NOT TOUCH ANY METAL PARTS OF THE TOOL!** Hold the tool only by insulated grasping surfaces to prevent electric shock if you drill or drive into a live wire.

SAVE THESE INSTRUCTIONS

Motor Brushes

Be sure tool is unplugged before inspecting brushes. To inspect brushes, unscrew the plastic brush inspection caps (located in the sides of the motor housing) and withdraw the brush assemblies from the tool.

Keep brushes clean and sliding freely in their guides. Carbon brushes have varying symbols stamped into them, and if the brush is worn down to a point where the symbol is not visible, they must be replaced. New brush assemblies are available at Service Centers; see TOOLS, ELECTRIC in the Yellow Pages.

NOTE: This tool is designed to automatically turn itself off when the brushes are worn out.

Spade Handle Assembly: (Fig. 1)

This spade handle can be attached either horizontally or vertically. Place the handle into the locating boss on the back of the drill and assemble with holding knob.

Side Handle (Fig. 1)

The side handle can be placed in either side of the drill or the top of the drill according to operator preference and available working clearance. The spade handle can be temporarily removed if working clearance at rear of tool is limited. Always replace spade handle when possible.

CAUTION: Always use the side handle and switch handle. This is a high-torque drill. Always hold it firmly with both hands when operating.

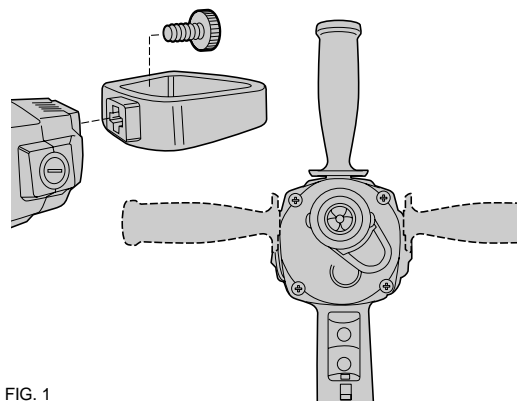
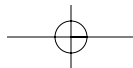

FIG. 1



Switch: (Fig. 2)

Pressing the TOP part of the switch runs the tool in a reverse direction. Pressing the BOTTOM part of the switch runs the tool in a forward direction. Always let the motor stop completely before changing direction.

To lock trigger in "FORWARD" position, depress LOWER part of lock button and push up lock button "B". Then, while holding lock button, gently release trigger. To release locking mechanism, depress lock button fully, then release it.

NOTE: Locking mechanism will not function if upper part of lock button is depressed (reverse operation).

The locking feature is for use when the drill is mounted in a vise or otherwise firmly held...**NOT BY HAND.**

Do not lock the switch "ON" when drilling by hand. If the bit binds, instantly release the trigger switch if the bit binds in the hole. Be sure to release the switch locking button before disconnecting the plug from the power supply. Failure to do so will cause damage to the plug immediately the next time it is plugged in. Damage will result.

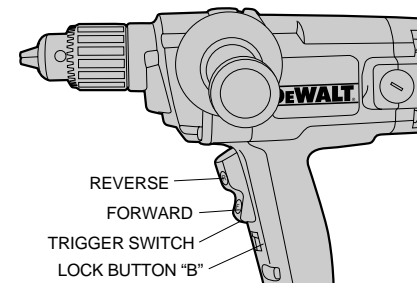

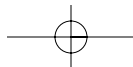

Drilling in Wood

Holes in wood can be made with the same twist drills used for metal. These bits may overheat unless pulled out frequently to clear chips from the flutes. For larger holes, use power drill wood bits. Work that is apt to splinter should be backed up with a block of wood.

Drilling in Masonry

Use carbide tipped masonry bits at low speeds. Keep even force on the drill but not so much that you crack the brittle materials. A smooth, even flow of dust indicates the proper drilling rate.

Chuck Key Holder

1. Push double-hole end of holder through slot in other end of holder. (Figure 3).
2. Slip loop over electric plug and draw loop tight around cord (Figure 4).
3. Push ends of chuck key handle through two holes in end of holder (Figure 6).

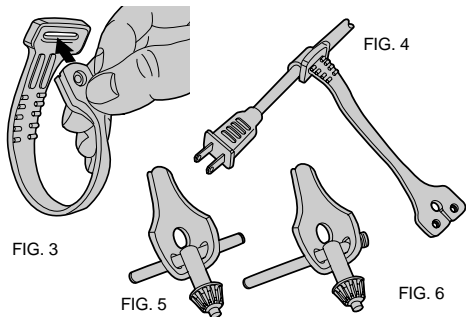

Chuck Removal (Figures 7 & 8)

1. Place chuck key in chuck as shown in Figure 7. Using a wooden mallet or similar object, strike key sharply in a **CLOCKWISE** direction. This will loosen screw inside chuck.
2. Open chuck jaws fully. Insert screwdriver into front of chuck between jaws to engage screw head. Remove screw by turning clockwise (left-hand thread).
3. Place key in chuck as shown in Figure 8. Using a wooden mallet or similar object, strike key sharply in a **COUNTERCLOCKWISE** direction. This will loosen chuck so that it can be unscrewed by hand.

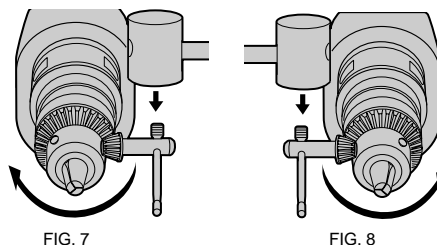

Lubrication

All ball bearings used are factory lubricated to last the life of the bearings. All needle bearings used receive their lubrication from the grease in the gear case. Clean and re-lubricate gear case yearly or whenever servicing requires the gear case to be removed. Use type and quantity of grease shown on Parts Bulletin packed with your tool. Gear case is removed by removing the three screws from the front of the tool. If the chuck is too large to permit removal of the two top screws, see instructions for chuck removal.

Accessories

Recommended accessories for use with your tool are available at a cost from your local service center. CAUTION: The use of any recommended accessory may be hazardous.

A complete listing of service centers is included with your tool. If you need any assistance in locating any accessory, contact DeWalt Industrial Tool Company, P.O. Box 158, 6260 DeWalt Drive, Hampstead, MD 21074 or call 1-800-4-DEWALT (1-800-435-9272).

Maximum Recommended Capacity

BITS, METAL DRILLING	1/2"
WOOD, FLAT BORING	1/2"
BITS, MASONRY DRILLING	3/8"
HOLE SAWS	4"
WIRE WHEEL BRUSHES	4"
WIRE CUP BRUSH	3"
BUFFING WHEELS	3"
RUBBER BACKING PADS	4"

Important

To assure product SAFETY and RELIABILITY, repair and adjustment should be performed by Black & Decker Industrial Service Centers or other qualified service organizations. These service organizations service DeWalt tools always use replacement parts.

DeWalt tools are serviced by the Industrial Tool Division of DeWalt Decker (U.S.) Inc.

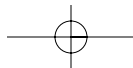

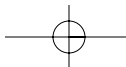

nty

duty industrial tools are warranted for one year chase. We will repair, without charge, any defects terials or workmanship. Arrangements have been ndustrial Tool Division of Black & Decker (U.S.) warranty repairs for DeWalt tools. Please return it, transportation prepaid, to any Black & Decker rial Service Center or Authorized Service Station ols, Electric” in the Yellow Pages. This warranty o accessories or damage caused where repairs e or attempted by others. This warranty gives you ghts and you may have other rights which vary te.

warranty, DeWalt tools are covered by our:

NO RISK SATISFACTION GUARANTEE

ompletely satisfied with the performance of your duty industrial tool, simply return it to the er within 30 days for a full refund. Please return it, transportation prepaid. Proof of purchase may



See 'Tools-Electric'
–Yellow Pages–
for Service & Sales

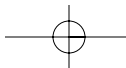

YOUR DeWALT TOOLS MAY BE SERVICED AT THE FOLLOWING B&D SERVICE CENTERS.

ALABAMA: Birmingham 35209, 2412 Green Springs Hwy. 205-942-0538 Mobile 36608, 3831 Airport Blvd. 205-343-6624	IOWA: Des Moines 50310, 3427 Merle Hay Rd. 515-270-1340	OHIO (CONT'D) Parma Heights (Cleveland) 44130, 6483 Pearl Road. Toledo 43607, 3231 Dorr St.
ALASKA: Anchorage 99518, 910 West International Airport Rd. 907-563-4664	KANSAS: Wichita 67213, 155 S. West St. 316-943-1271	OKLAHOMA: Oklahoma City 73106, 1318 Linwood Blvd. Tulsa 74145, 3120 S. Sheridan Rd.
ARIZONA: Mesa 85202, 535 S. Dobson, Suite 7. 602-461-1074 Phoenix 85013, 4501 N. 7th Avenue 602-279-6414 Tucson 85712, 4845 E. Speedway Blvd. 602-323-3388	KENTUCKY: Louisville 40213, 5211 Preston Hwy. 502-968-7100	OREGON: Portland 97209, 1640 N.W. Johnson St. Lancaster 17601, 118 Keller Ave.
ARKANSAS: Little Rock 72201, 519 W. Seventh St. 501-372-3040	LOUISIANA: Baton Rouge 70815, 11859 Florida Blvd. 504-272-8111 Harvey 70058, 2500 Lapalco Blvd. 504-366-8676 Metairie (New Orleans) 70002, 3604 N. Causeway Blvd. Shreveport 71108, 7710-7714 Jewella Rd. 318-688-1553	PENNSYLVANIA: Evanston City 19033, 20808 Rt. 19 North Harrisburg 17112, 6080 Allentown Blvd. Lancaster 17601, 118 Keller Ave. Philadelphia 19103, 333 N. 20th St. Philadelphia (North) 19115, 9977-81 Bustleton Ave. Pittsburg 15232, 5437 Baum Blvd. Whitehall (Allentown) 18052, 2242 MacArthur Rd. Wilkes-Barre 18702, 759 Kidder Street
CALIFORNIA: Anaheim 92806, 540 South State College Blvd. 714-772-4050 Chula Vista 91910, 309 Broadway 619-420-6350 Concord 94520, 1500 Monument Blvd., #C2. 510-682-4880 Fresno 93710, 5412 North Blackstone Ave. 209-435-0810 Long Beach 90805, 2011 South St. 310-422-5825 Los Angeles 90040, 4820 South Eastern Ave., Suite "L". 213-720-1834 Riverside 92506, 6215 Magnolia Ave., Suite "B". 959-787-9700 Sacramento 95825, 2033 Fulton Ave. 916-972-9090 San Diego 92123, 9270 Clairemont Mesa Blvd. 619-279-2011 San Jose 95128, 1185 So. Bascom Ave. 408-253-7350 San Leandro 94578, 15206 E. 14th St. 510-276-1610 Van Nuys 91411, 14920 Victory Blvd. 818-787-5531	MARYLAND: Baltimore (East) 21205, 4712 Erdman Ave. 410-495-5550 Baltimore (North) 21030, 29-31 Cranbrook Rd., Cockeysville 410-666-5966 Baltimore (South) 21122, 8220 Ritchie Hwy., Pasadena 410-647-8456 Colmar Manor 20722, 4153 Bladensburg Rd. 301-779-3808	PUERTO RICO: Puerto Nuevo
COLORADO: Denver 80219, 1171 S. Federal Blvd. 303-922-8325	MASSACHUSETTS: Brighton (Boston) 02135, 12 Market St. 617-782-6264 Seekonk 02771, 120 Highland Ave. 508-336-6510	RHODE ISLAND: See Seekonk, MA
CONNECTICUT: Orange 06477, 481 Boston Post Rd. 203-796-3583 Wethersfield (Hartford) 06109, 662 Silas Dean Hwy. 203-563-5800	MICHIGAN: Grand Rapids 49512, 3040 28th St., S.E. 616-949-8331 Lansing 48917, 3203 W. Saginaw Hwy. 517-323-4181 Warren 48093, 27035 Van Dyke Blvd. 313-756-6711 Westland (Detroit) 48185, 8067 North Wayne Rd. 313-427-1520	SOUTH CAROLINA: Greenville 29607, 1557 Laurens Rd. Chattanooga 37421, 6231 Perimeter Drive, Space E. Knoxville 37917, 4118 N. Broadway
DISTRICT OF COLUMBIA: Washington Colmar Manor 20722, 4153 Bladensburg Rd. 301-779-3808 Falls Church, VA 22046, 344 W. Broad St. 703-533-7313	MINNESOTA: Bloomington (Minneapolis-St. Paul) 55420, 9517 Lyndale Ave., S. 612-894-9191	TEXAS: Amarillo 79106, 3008 West 6th Ave. Austin 78757, 6549 Burnet Rd. Dallas 75229, 2257 Royal Ln. El Paso 79915, 6822 Gateway East ... Fort Worth 76111, 721 North Beach St. Garland 75043, 718 W. Centerville Rd. Houston 77022, 536 E. Tidwell Rd. Houston (S.W.) 77025, 9319 Stella Link Blvd. San Antonio 78201, 500 Culebra Ave. Webster 77598, 100 East Nasa Rd. One
FLORIDA: Fl. Lauderdale 33334, 799 E. Oakland Pk. Blvd. 305-566-5102 Fl. Myers 33907, 5224 Bank Street. 813-278-1188 Jacksonville 32205, 920 Cassat Ave. 904-781-2253 Miami (North) 33168, 13345 N.W. Seventh Ave. 305-681-6658 Miami (South) 33156, 12233 So. Dixie Hwy. 305-232-9497 Orlando 32803, 3807 E. Colonial Dr. 407-894-7011 St. Petersburg 33709, 5635 49th St., N. 813-525-0273 Tampa 33609, 3432 W. Kennedy Blvd. 813-872-8317 West Palm Beach 33415, 310 South Military Trail 407-689-3247	MISSOURI: Kansas City 64111, 4324 Main St. 816-531-0629 St. Ann (North St. Louis) 63074, 3637 North Lindbergh Blvd. 314-739-6661 St. Louis 63131, 12852 Manchester Rd. 314-821-8740	UTAH: Salt Lake City 84115, 1541 S. Third West St.
GEORGIA: Atlanta (South) 30348, 5330 Old National Hwy. 404-762-8844 Smyrna 30080, 2550 Cobb Pkwy. 404-956-0869 Stone Mountain (Atlanta) 30086, 5723 Memorial Dr. 404-292-4714	NEBRASKA: Omaha 68127, 4225 S. 84th St. 402-592-5666	VIRGINIA: Falls Church 22046, 344 W. Broad St. Hampton 23686, 3416 W. Mercury Blvd. Norfolk 23513, 7631 Sewells Point Rd. Richmond 23222, 1424 Chamberlayne Ave.
HAWAII: Honolulu 96819, 330 Sand Island Access Road. 808-847-7447	NEVADA: Las Vegas 89104, 3411 East Charleston Blvd. 702-641-6555	WASHINGTON: Seattle 98108, 421 S. Michigan St. Spokane 99208, N. 7011 Division St. Tacoma 98409, 2602 S. 38th St.
ILLINOIS: Des Plaines (Chicago) 60018, 1277 South Elmhurst Rd. 708-364-5220 Lincolnwood (Chicago) 60466, 6710 N. Crawford Ave. 708-673-0923 Lisle (West Chicago) 60532, 2950 Ogden Ave., Unit H. 708-717-1075 Moline 61265, 4433 23rd Ave. 309-762-3000 Oak Lawn (Chicago) 60453, 6343 W. 96th St. 708-423-7212 Waukegan 60085, 39 S. Greenbay Rd. 708-249-4390	NEW JERSEY: Cherry Hill 08034, 1444 E. Marlton Pike/Rte. 70. 609-429-2822 Little Falls 07424, 1189 U.S. Highway 46. 201-256-9373 Union (Scotch Plains) 07076, 2520 Route #22 East. 908-233-5665	WEST VIRGINIA: Charleston 25312, 1638 Sixth Ave. Milwaukee (Wauwatosa) 53226, 10424 West Bluemoor
INDIANA: Evansville 47710, 307 First Ave., Crescent Ct. 812-425-4269 Hammond 46323, 7103 Kennedy Ave. 219-845-5100 Indianapolis 46224, 5999 Crawfordsville Rd. 317-243-8308	NEW MEXICO: Albuquerque 87110, 5617 Menaul Blvd., N.E. 505-884-1002	
	NEW YORK: Buffalo 14209, 881 W. Delavan Ave. 716-894-6220 Centersuch L.I. 11720, 2061-63 Middle Country Rd. 516-737-4706 Elmhurst (New York) 11373, 77-20 Queens Blvd. 718-335-1042 Latham (Albany) 12110, 636 Troy-Schenectady Rd. 518-785-1867 Rochester 14623, 2969 W. Henrietta Rd. 716-424-1310 Syracuse 13214, 3485 Erie Blvd., East. 315-446-3086 Westbury L.I. (New York) 11590, 1061 Old Country Rd. 516-997-6140	
	NORTH CAROLINA: Charlotte 28205, 3007 E. Independence Blvd. 704-374-1779 Greensboro 27407, 3716 High Point Rd. 910-852-1300 Raleigh 27604, 2930 Capital Blvd. 919-878-0357	
	OHIO: Cincinnati 45241, 2310 E. Sharon Rd. 513-772-3111 Columbus 43227, 3975 E. Livingston Ave. 614-237-0461 Dayton 45409, 2898 S. Dixie Dr. 513-298-1951 Mayfield Heights (East Cleveland) 44124, 5881 Mayfield Rd. 216-449-2770	