



Westinghouse

USER'S MANUAL
MANUEL DE L'UTILISATEUR
MANUAL DEL USUARIO

SK-16H120S

Widescreen HDTV

TVHD à Écran Géant

TVHD Pantalla Grande



www.westinghousedigital.com

WELCOME	2
PACKAGE CONTENTS	2
DOLBY DIGITAL.....	2
IMPORTANT PRODUCT SAFETY INSTRUCTIONS	4
PRODUCT SAFETY.....	4
FCC COMPLIANCE STATEMENT	5
SAFETY INSTRUCTIONS	6
ANTENNA INSTALLATION SAFETY	7
INTRODUCTION: THE BASICS	8
Digital Television (DTV).....	8
High Definition Television (HDTV)	8
About the Digital Television Picture	9
About Digital Channels	10
The Electronic Program Guide (EPG)	11
INTRODUCTION: CONTROLS AND CONNECTIONS	12
PT-16H120S Controls and Connections.....	12
PT-19H140S Controls and Connections.....	14
PT-19H520S Controls and Connections.....	15
REAR MOUNTED CONNECTORS.....	17
QUICK REFERENCE: HDTV CONNECTION	18
INSTALL BASE.....	18
INSERTING REMOTE CONTROL BATTERIES	19
REMOTE CONTROL FEATURES.....	20
HDTV REMOTE CONTROL TIPS.....	22
HDTV/ACCESSORY SETUP	23
CONNECTING YOUR HDTV	23
CONNECTING YOUR PERSONAL COMPUTER	24
CONNECTING OTHER ACCESSORIES	25
HDTV OPERATION	26
SETTINGS VIDEO MENU	26
Color Temp.....	27
AUDIO MENU.....	28
SETUP MENU	29
CHANNELS MENU IN DTV AND TV INPUTS.....	30
LOCK MENU IN DTV AND TV INPUTS	31
TIME MENU IN DTV AND TV INPUTS.....	32
ABOUT PARENTAL CONTROLS.....	33
Parental Controls (USA)	34
US TV Ratings & Content.....	35
Parental Controls (CANADA).....	36
APPENDIX:.....	37
SPECIFICATIONS:	37
PT-16H120S High Definition LCD TV Specifications.....	37
PT-19H140S High Definition LCD TV Specifications.....	38
PT-19H520S High Definition LCD TV Specifications.....	39
TROUBLESHOOTING.....	40
CLEANING THE HIGH DEFINITION LCD TV.....	42
WALL MOUNTING (OPTIONAL)	43

WELCOME

Congratulations on the purchase of your High Definition LCD TV—and thank you for choosing Westinghouse. This User Manual was created to ensure simple, safe setup and use of all the features offered by your new HDTV.

PACKAGE CONTENTS

In addition to your new Westinghouse HDTV and this User Manual, you'll also find the following:

- Quick Setup Guide
- Remote control
- 2 AAA batteries
- AC power cord
- Warranty card
- Stand (wall-mount accessories available separately)

Contacting Westinghouse Digital Electronics



If you still have questions or require assistance after reading the Quick Setup Guide and the instructions in this User Manual, please contact Westinghouse Customer Service at 1-866-287-5555, or visit our Web site at www.wde.com.

Don't forget to complete and return your Warranty card or use our online Product Registration feature. Your Westinghouse HDTV is warranted for defects in materials or workmanship for a period of one year from original date of purchase.

DOLBY DIGITAL

Manufactured under license from Dolby Laboratories. Dolby and the double-D symbol are trademarks of Dolby Laboratories.

Explanations of required symbols:

SYMBOL	SYMBOL DEFINITION
 <p data-bbox="435 594 545 625">SA 1965</p>	<p data-bbox="727 407 1040 434">DANGEROUS VOLTAGE:</p> <p data-bbox="727 438 1385 590">The lightning flash with arrowhead symbol, within an equilateral triangle, is intended to alert the user to the presence of uninsulated “dangerous voltage” within the product’s enclosure that may be of sufficient magnitude to constitute a risk of electrical shock to persons.</p>
 <p data-bbox="431 888 537 919">SA 1966</p>	<p data-bbox="727 722 935 749">INSTRUCTIONS:</p> <p data-bbox="727 753 1385 873">The exclamation point with an equilateral triangle is intended to alert the user to the presence of important operating and maintenance (servicing) instructions in the literature accompanying the appliance.</p>

IMPORTANT PRODUCT SAFETY INSTRUCTIONS

PRODUCT SAFETY

WARNING: This device must be operated with the original power supply, part number DPS-210 EP 2 C.

CAUTION: The power supply outlet should be located near High Definition LCD TV and should be easily accessible. Always use the appropriate AC cord that is certified for your specific country. Some examples are listed below:

USA.....UL	Switzerland SEV
Canada.....CSA	Britain BASE/BS
Germany.....VDE	Japan Electric Appliance Control Act

IMPORTANT NOTICE CONCERNING POWER CORD SELECTION

The specific power cord for this High Definition LCD TV is enclosed and has been selected according to the country of destination and must be used to prevent electric shock. Use the following guidelines if it is necessary to replace the original cord set, or if the cord set is not enclosed. The female receptacle of the cord set must meet IEC-60320 requirements and should look like Figure A1 below:



For the United States and Canada

In the United States and Canada the male plug is a NEMA5-15 style (Figure A2), UL Listed, and CSA Labeled. For High Definition LCD TVs that are placed on a desk or table, type SVT or SJT cord sets may be used. For High Definition LCD TVs placed directly on the floor, only SJT type cord sets may be used. The cord set must be selected according to the current rating for the High Definition LCD TV. Please consult the table below for the selection criteria for power cords used in the United States and Canada.

Cord Type	Size of Conductors in Cord	Maximum Current Rating of Unit
SJT	18 AWG	10 Amps
	16 AWG	12 Amps
	14 AWG	12 Amps
SVT	18 AWG	10 Amps
	17 AWG	12 Amps

FCC Compliance Statement

This equipment has been tested and complies with the limits for a Class B digital device, pursuant to part 15 of the FCC Rules. These limits are designed to provide reasonable protection against harmful interference in a residential installation. This equipment generates, uses, and can radiate radio frequency energy, and may cause harmful interference to radio communications if not installed and used in accordance with the instructions. However, there is no guarantee that interference will not occur in a particular installation. If this equipment does cause harmful interference to radio or television reception, which can be determined by turning the equipment off and on, the user is encouraged to try to correct the interference by one or more of the following measures:

- Reorient or relocate the receiving antenna.
- Increase the separation between the High Definition LCD TV and receiver.
- Connect the equipment into an outlet on a circuit different from that to which the receiver is connected.
- Consult the Westinghouse Service Center or an experienced radio/TV technician for assistance.

FCC Warning

To assure continued FCC compliance, the user must use a grounded power supply cord and the provided shielded video interface cable with bonded ferrite cores. If a BNC cable is used, use only a shielded BNC (5) cable. Also, any unauthorized changes or modifications not expressly approved by Westinghouse Digital Electronics will void the user's authority to operate this device.

For tuner, according with UL60950-1

“Make sure that your CATV system installer has connected the Co-axial cable shield to the grounding system of the building, as close to the point of cable entry as practical.

The common or earthed side of the connected (SELV) circuits and any accessible metal parts should be connected to the screen of coaxial cable.”

The cable distribution system should be grounded (earthed) in accordance with ANSI/NFPA 70, the National Electrical Code (NEC), in particular Section 820.93, Grounding of Outer Conductive Shield of a Coaxial Cable.

SAFETY INSTRUCTIONS

Follow and obey all warnings and instructions marked on the High Definition LCD TV. For your safety, please read all of the following safety and operating instructions before you operate the High Definition LCD TV—and keep this User's Manual for future reference.

Important Safety Instructions

1. Never use your HDTV near water.
2. Clean only with dry cloth.
3. Never block any ventilation openings; install in accordance with the manufacturer's instructions.
4. Do not install near any heat sources such as radiators, heat registers, stoves or any other equipment (including amplifiers) that produce heat.
5. Take care to maintain the safety purpose of the polarized or grounding type plug. A polarized plug has two blades with one wider than the other. A grounding type plug has two blades and a third grounding prong. The wide blade or the third prong are provided for your safety; therefore, if the provided plug does not fit into your outlet, do not alter the plug in any way to fit; consult an electrician for replacement of the obsolete outlet.
6. Ensure the power cord is protected from being walked on or pinched, particularly at plugs, convenience receptacles and the point where they exit from the apparatus.
7. Only use attachments/accessories specified by the manufacturer.
8. Use only with the cart, stand, tripod, bracket, or table specified by the manufacturer, or sold with the apparatus. When a cart is used, use caution when moving the cart/apparatus combination to avoid the potential for injuries caused by tipping over.
9. Unplug this apparatus during lightning storms or when unused for long periods of time.
10. Refer all servicing to qualified service personnel. Servicing is required when the apparatus has been damaged in any way, such as: damage to the power supply cord or plug; liquid has been spilled into—or objects have fallen onto—the apparatus; the apparatus has been exposed to rain or moisture and does not operate normally, or it has been dropped.



Other Notices

- Avoid exposing the High Definition LCD TV to direct sunlight or high temperatures.
- Avoid exposing the High Definition LCD TV to moisture or high humidity.
- Do not attempt repairs yourself. Your warranty does not cover repairs or attempted repairs by anyone not authorized by the manufacturer.
- If your High Definition LCD TV will not be used for a long period of time, unplug your HDTV and remove the batteries from the remote control.
- Only use attachments/accessories specified by the manufacturer.
- Avoid touching the screen. Skin oils are difficult to remove.
- Never remove the rear cover. Your High Definition LCD TV contains high-voltage parts. You may be seriously injured if you touch them.
- Always handle your LCD display with care when moving it.
- If the High Definition LCD TV emits smoke, abnormal noise, or a strange odor, immediately turn it off and contact the Westinghouse Service Center.

Antenna Installation Safety

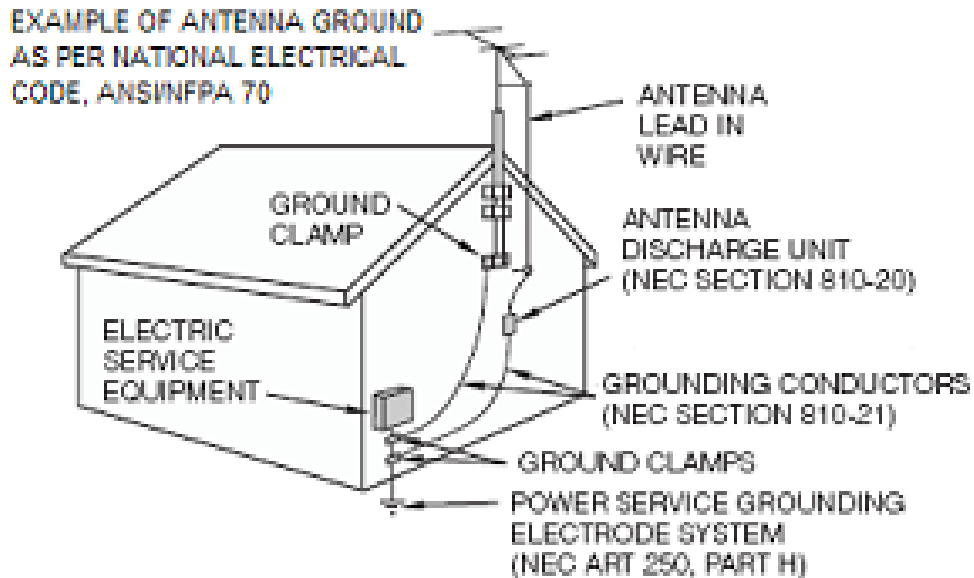

Outdoor Antenna Grounding

If an outside antenna or cable system is connected to the High Definition LCD TV, be sure the antenna or cable system is grounded to prevent voltage surges and built-up static charges. Article 810 of the National Electrical Code, ANS/NFPA 70, provides information on proper grounding of the mast and supporting structure, grounding of the lead-in wire to an antenna discharge unit, connection to grounding electrodes, and requirements for the grounding electrode.

Lightning

For added protection for the High Definition LCD TV during a lightning storm, or when it is left unattended and unused for long periods of time, unplug it from the wall outlet and disconnect the antenna or cable system. This will prevent damage to the High Definition LCD TV due to lightning and power-line surges. Do not disconnect the antenna or the power cord during a heavy storm—lightning may strike while you are holding the cable cord, causing serious injury. Turn off your High Definition LCD TV and wait for the weather to improve.

Power Lines

An outside antenna system should not be located in the vicinity of overhead power lines or other electric light or power circuits. When installing an outside antenna system, extreme care should be taken to keep from touching such power lines or circuits.

INTRODUCTION: THE BASICS

Digital Television (DTV)

Television broadcasting is changing. By February of 2009, traditional analog TV transmissions (the standard since TV's inception) will cease to exist, in compliance with a federal mandate requiring all U.S. television stations to convert from analog to the new digital television (DTV) standards.

In contrast to the magnetic waves used for analog transmission (also known as NTSC, short for National Television Standards Committee), DTV transmits images and sound as data, using ones and zeroes, the same digital code computers use. As a result of this increased efficiency, DTV offers an array of benefits including dramatic improvements to picture and sound quality. In addition, DTV allows the same number of stations to broadcast using fewer channels, freeing parts of the broadcast spectrum for other uses, such as public safety and wireless services

NOTE: DTV should not be confused with digital cable or digital satellite systems. While these systems receive digital signals, the signals are converted to analog for display on channel 3 or 4 of an analog TV.

High Definition Television (HDTV)

The most common DTV formats are Standard Definition Television (SDTV) and High Definition Television (HDTV). Of the two, HDTV delivers digital broadcasting's highest resolution and picture quality. HDTV also uses a "widescreen format," which refers to the aspect ratio (screen width vs. height) of the image. To put this in perspective, analog television uses a 4x3 aspect ratio; HDTV's aspect ratio is 16x9, creating a more cinematic-like viewing experience. Plus HDTV increases the number of horizontal scan lines on the screen, enabling it to render greater picture detail. And, while HDTV uses approximately the same bandwidth, it transmits approximately six times more information, further enhancing video and audio clarity.

About the Digital Television Picture

Your new Westinghouse High Definition LCD TV has a built-in HDTV/NTSC tuner, meaning it can receive both analog and digital broadcasts from your antenna, cable or satellite service. But because not all broadcasters have converted to the new DTV standards, it's important to understand some fundamentals of the digital television picture.

The elements that make up onscreen images are pixels. The more pixels, the more detail, because the number of pixels determines picture resolution—and HDTV offers the highest pixel count and best resolution available. HDTV resolution is available in both 720p and 1080i formats. The "p" and "i" refer to the scanning method used to deliver the lines of resolution on the screen. Progressive "p" scanning means that pixels on the screen are refreshed simultaneously, with each scan showing every line for a complete picture at 1/60th of a second. Interlaced "i" scanning refreshes pixels by alternating first, by showing every odd line, then following with the even lines—for a complete picture at 1/30th of a second.

True high definition image quality is possible only with a true high definition display—and a 720p or 1080i signal coming into your HDTV. Lower resolution images from analog broadcasts or VHS recordings, for example, may result in disappointing picture quality as they simply don't have enough detail to display well in high-definition. If you have cable or satellite service, you'll want to check with your provider to determine which packages include stations broadcasting in high definition, and if you need a different box or tuner to receive HDTV signals. And, as more and more broadcasters change to a digital signal, you will be able to view all of your programming choices in stunning high definition—and the luxury of your personal home theater experience.

About Digital Channels

Currently, all broadcasters have an analog TV channel and a digital TV channel. The digital bandwidth has the capability of accommodating more than one program stream because each broadcaster's assigned digital channel carries a 19.39-megabit-per-second (Mbps) digital data stream. This allows the broadcaster the option of broadcasting a single program or dividing the digital data stream into multiple programming streams. These streams include the "major" channel specific to a broadcasting station, as well as any additional programming streams on the bandwidth, which are referred to as "minor channels" or "sub-channels," each broadcasting a different program. As a result, the numbering system for digital channels is different than that of traditional analog TV.



Here's how it works:

- Each physical channel is mapped to one or more digital channel numbers, known as "virtual channels," and represented by a number, followed by a dot and then another number; for example, 7.1, 7.2, etc. (the old analog channel is always referenced to minor channel "0", as in 7.0, while 7.1 would represent the new digital television channel)
 - The first number is the major channel used for all channels of a particular broadcasting station
 - The number following the dot is the minor channel number assigned to each broadcaster's additional programming streams; digital television stations may have only one virtual channel, or as many as six

The Electronic Program Guide (EPG)

Your Westinghouse High Definition LCD TV features an on-screen interactive Electronic Program Guide (EPG) that allows you to review program information, as well as navigate through any available minor programming.

To access the EPG, push the “Guide” button on the lower left side of your remote, scroll to the “EPG” feature under “Guide” section of the On Screen Display’s (OSD) TV menu.

EPG includes:

- current channel, program name and description, along with programming titles, start and end times for all available minor channels from the same broadcaster

EPG also provides:

- Content resolution, Closed Caption information
- Program rating

To exit EPG, simply press the “Guide” button again.



INTRODUCTION: Controls and Connections

PT-16H120S Controls and Connections

Front View

Use buttons on the right front side of your HDTV (or keys on remote control) for On Screen Display (OSD), volume adjustment, channel selection, source, and turning power on or off.

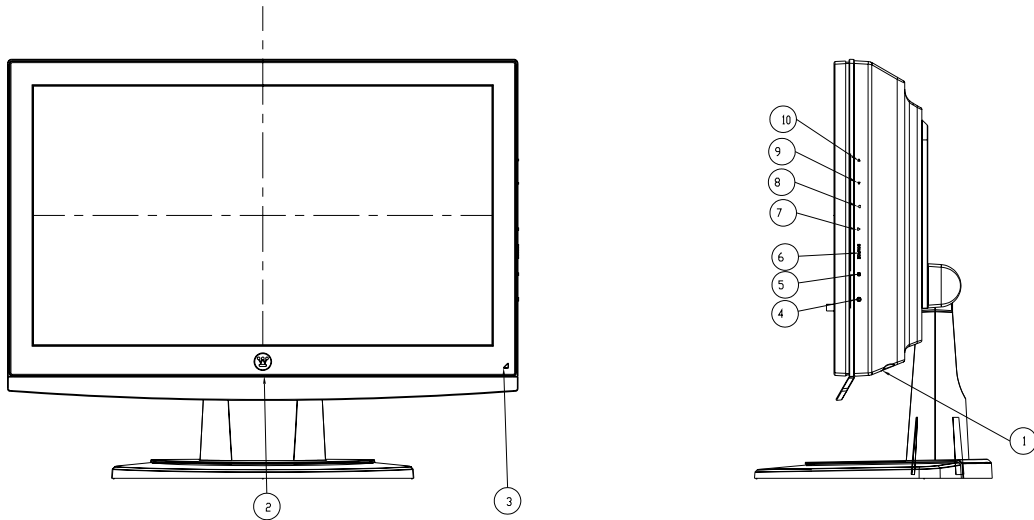

No.	Name	Descriptions	
1	Speaker	3.5w*2	
2	LED Indicator	White	Normal operation
		Blinking	Power management
		Off	Power off
3	IR Receiver	Infrared Receiver Module	
4	Power Switch	Power on / Power off	
5	MENU	OSD control MENU button	
6	Source	Source Selection	
7	▶	Volume decrease	
8	◀	Volume increase	
9	▼	Channel down	
10	▲	Channel up	

Rear View

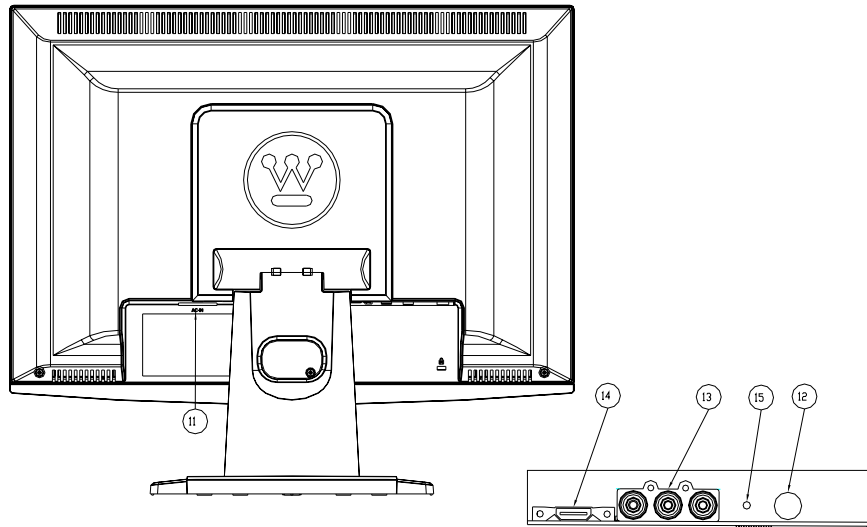

No.	Name	Descriptions
11	AC-In	AC Power Jack
12	ANT	Terrestrial or CATV Connector
13	Video + Audio R/L	RCA Stereo Audio and Video Connector for Composite Video
14	HDMI	High-definition Multimedia Interface
15	Phone Jack	Phone Jack 5P Ø3.5 90°

PT-19H140S Controls and Connections

Front & Rear View

Use buttons on the right front side of your HDTV (or keys on remote control) for On Screen Display (OSD), volume adjustment, channel selection, source, and turning power on or off.

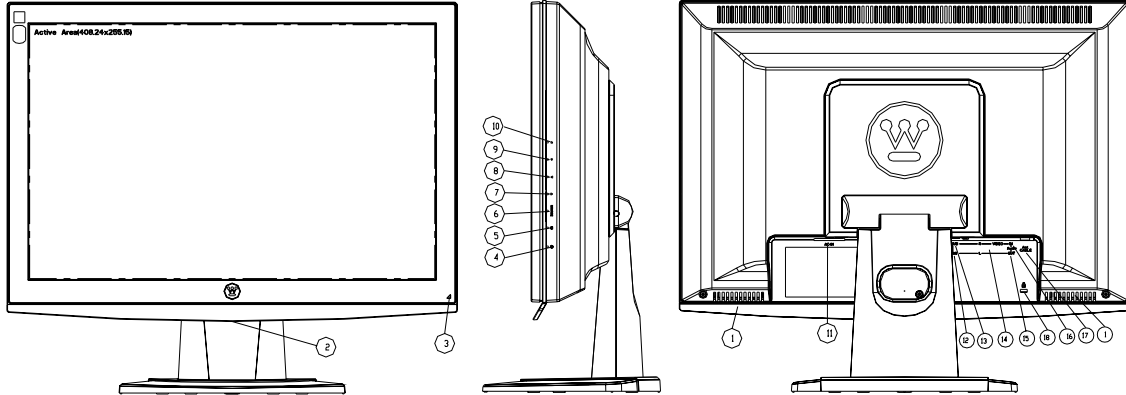

No.	Name	Descriptions
1	Speaker	3.5w*2
2	LED Indicator	White Normal operation
		Blinking Power management
		Off Power off
3	IR Receiver	Infrared Receiver Module
4	Power Switch	Power on / Power off
5	MENU	OSD control MENU button
6	Source	Source Selection
7	▶	Volume decrease
8	◀	Volume increase
9	▼	Channel down
10	▲	Channel up
11	AC In	AC Power Jack
12	HDMI	High-definition Multimedia Interface
13	D-Sub	D-sub mini 15pin Connector
14	Video + Audio R/L	RCA Stereo Audio and Video Connector for Composite Video
15	Line Out	Jack d=3.5 mm, Stereo Audio Connector
16	Line In	Jack d=3.5 mm, Stereo Audio Connector
17	ANT	Terrestrial or CATV Connector
18	Lock hole	Kensington

PT-19H520S Controls and Connections

Front View

Use buttons on the right front side of your HDTV (or keys on remote control) for On Screen Display (OSD), volume adjustment, channel selection, source, and turning power on or off.

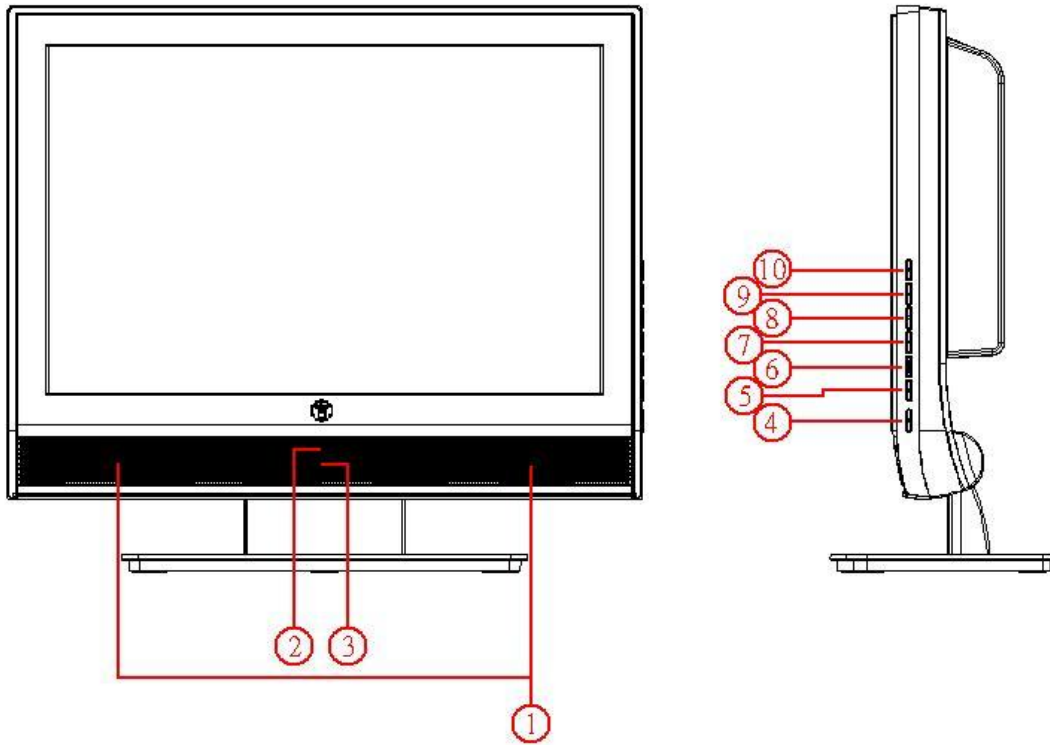

No.	Name	Descriptions	
1	Speaker	3.5w*2	
2	LED Indicator	Blue	Normal operation
		Orange	Power management
		Off	Power off
3	IR Receiver	Infrared Receiver Module	
4	Power Switch	Power on / Power off	
5	MENU	OSD control MENU button	
6	Source	Source Selection	
7	▶	Volume decrease	
8	◀	Volume increase	
9	▼	Channel down	
10	▲	Channel up	

Rear View

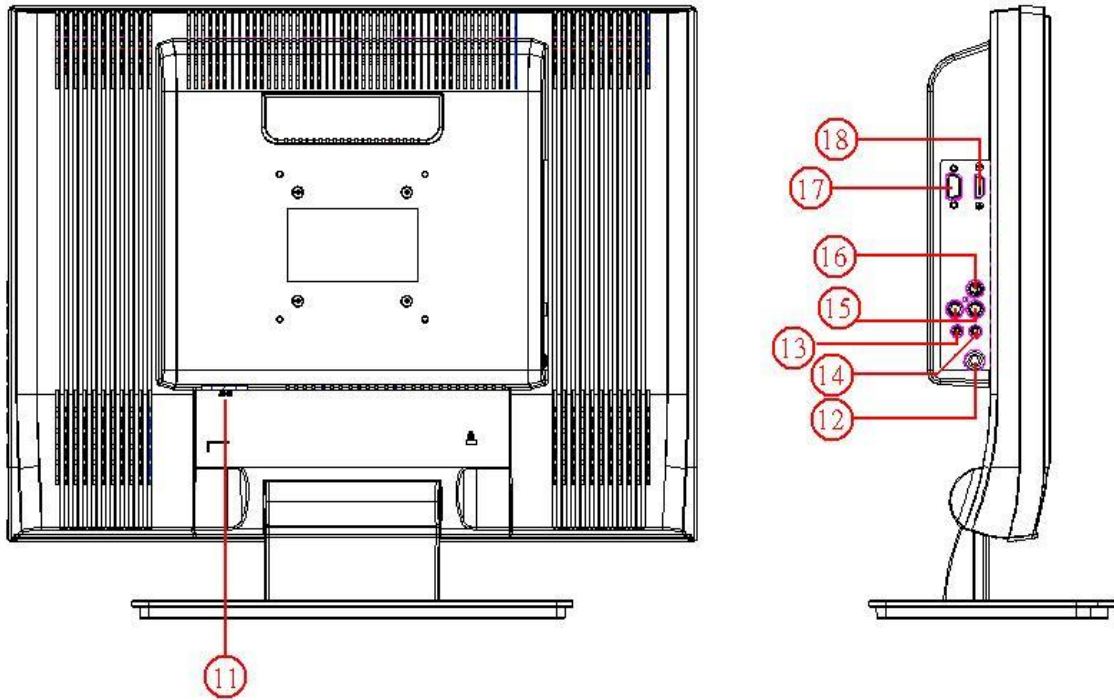

No.	Name	Descriptions
11	AC-In	AC Power Jack
12	ANT	Terrestrial or CATV Connector
13	Line In	Jack d=3.5 mm, Stereo Audio Connector
14	Line Out	Jack d=3.5 mm, Stereo Audio Connector
15	Audio R/L	RCA Stereo Audio Connector for Composite Video
16	Video	RCA Composite Video
17	D-Sub	D-sub mini 15pin Connector
18	HDMI	High-definition Multimedia Interface

Rear Mounted Connectors

BACK SIDE CONNECTORS



1. **VGA** (This feature is not available on PT-16H120S HDTV)
Connect personal computer using a 15-pin VGA cable



2. **Audio In for VGA or DVI-HDMI (optional with VGA)**
Connect PC using a 3.5mm mini-jack cable from PC's Audio Out



3. **HDMI**
Connect external HDMI device like a DVD, cable/satellite receiver or personal computer (using a DVI-HDMI cable, not supplied)



4. **AV Video/Audio (Right/Left)**
Connect an external video device like a VCR (Audio Right/Left supports S-Video or AV input)



5. **Audio Out**
Connect stereo headset with a 3.5mm mini-jack from TV's Audio Out



6. **ANT/Cable**
Connect antenna or cable service



7. **VESA 100 mm Wall Mount Holes**
Use for attaching VESA 100 mm wall mount bracket

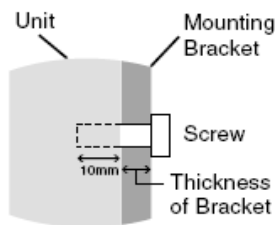

Screw length should equal depth of hole (10mm) + the thickness of mounting bracket.

8. **Please note the following when mounting on wall or ceiling**
 - When using mounting accessories must comply with the VESA-compatible mounting method.
 - Recommends using size M4 screws (10mm + thickness of bracket in length). If using screws longer than 10mm, check the depth of the hole.
 - Prior to mounting, inspect the installation location to insure that it is strong enough to support the weight of the unit so that the unit will be safe from harm.
 - Refer to the instructions included with the mounting equipment for detailed information.



9. **AC-IN (Power)**
Connect to power source via supplied power cord

See pages **23-25** for more information about connecting cable/satellite receivers, game consoles, VCR and DVD player/recorders, audio devices and your personal computer.

Quick Reference: HDTV Connection

HDMI (High Definition Multimedia Interface)

Provide superior level of digital video quality; includes DVD, cable/satellite receivers or personal computers

S-Video Input

The “S(uper)-Video” connection provides enhanced picture clarity for selected accessory sources such as a digital broadcast satellite service, video games, DVD and VHS. ***Accessory source must have S-Video output jack.***

Install Base

1. Place the base on a flat surface and
2. Align the holes and tabs between the TV neck and the base
3. Slide TV neck onto the base until it snaps into place

To remove the base stand, place your 16” or 19” HDTV face down on a flat and soft surface, press the tabs on the bottom of the stand neck and then remove the base

Inserting Remote Control Batteries

1. Remove the battery compartment cover
2. Insert the batteries corresponding to the (+) and (-) marks inside the battery compartment
3. Reattach cover



Precautions:

- Only use AAA batteries
- Don't mix new and old batteries, which can result in cracking or leakage and may pose a risk for fire or personal injury
- Make sure you insert batteries according to (+) and (-) markings; incorrect battery installation can result in cracking or leakage and may pose a risk for fire or personal injury
- Always dispose of used batteries in accordance with local laws and regulations
- Keep all batteries away from children and pets
- Remove batteries when the remote control will not be used for an extended period of time

Remote Control Features

1. **POWER**
Switch the power On/Off
2. **PIP**
Display sub picture On/Off
Note: This feature is not available on this HDTV.
3. **MUTE**
Turn the sound On/Off
4. **SWAP**
Switch between PIP and Main Picture
Note: This feature is not available on this HDTV.
5. **BACKLIGHT**
Shortcut to adjust backlight adjustment
Note: This feature is not available on this HDTV.
6. **CC**
Turn Closed Caption On/Off
7. **SLEEP**
Set sleep timer
8. **FAVORITE CHANNEL A / B / C**
Jump to favorite channels (Hold button for 3 seconds to program favorite channel).
9. **CHANNEL NUMBER KEYS**
Select specific channels
10. **DOT**
To input dot when selecting digital channels
11. **ENT**
Complete channel selection
12. **INPUT**
Display MP input menu
13. **VOL - / +**
Volume Up/Down adjustment
14. **CH ▼ / ▲**
TV Channel Up/Down adjustment
15. **SCALING**
Set video display format to "STANDARD", "FILL"
16. **MENU**
Turn OSD Menu On/Off
17. **BACK/RETURN**
Go back to previous page (menu selection) or channel (watching TV)
18. **▼ / ▲ / ◀ / ▶**
Navigate within OSD Menu
19. **ENTER**
Make a selection
20. **EPG**
Display Electronic Program Guide
21. **INFO**
Display the source and channel information

22. YPbPr1

Switch to YPbPr1 source

Note: This feature is not available on this HDTV.

23. PC

Switch to VGA source

Note: This feature is not available on 16" (PT-16H120S) HDTV.

24. TV

Switch and toggle between DTV and regular TV sources.

25. HDMI

Switch to HDMI source

26. YPbPr2

Switch to YPbPr2 source

Note: This feature is not available on this HDTV.

27. AV

Switch to AV source

28. DVI

Switch to DVI source

Note: This feature is not available on this HDTV.

29. S-VIDEO

Switch to S-Video source

Note: This feature is not available on this HDTV.

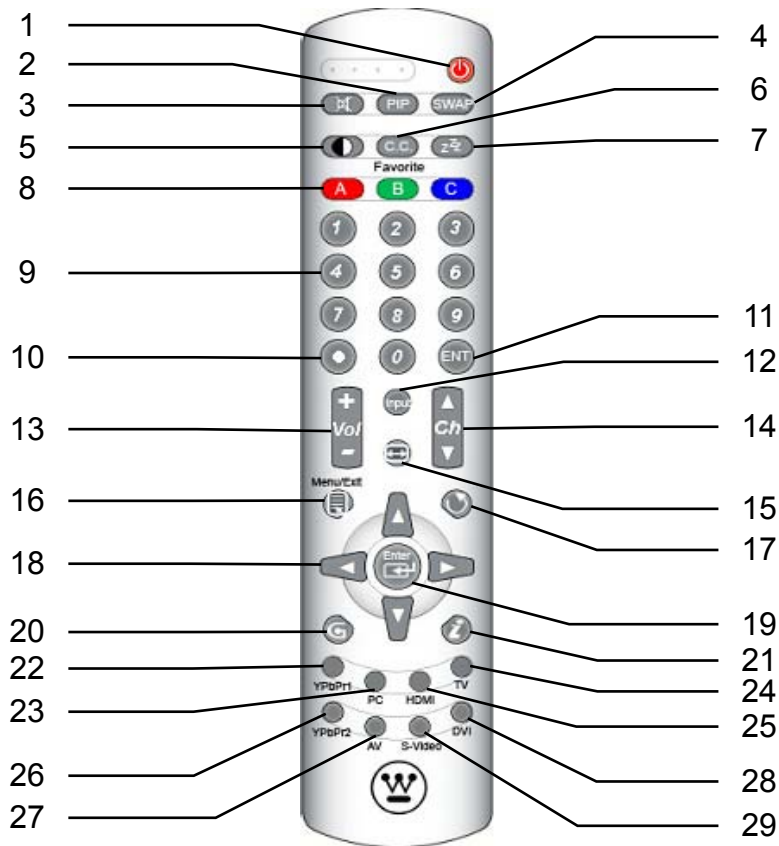

HDTV Remote Control TIPS

Keep remote control 3~18 feet away, in front of IR receiver from HDTV, within 50° circle range to have the best signal reception.

PT-16H120S & PT-19H140S

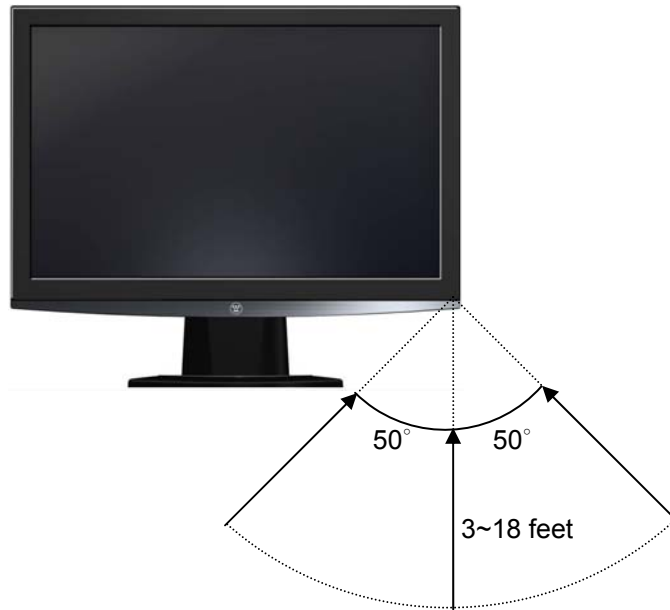

PT-19H520S

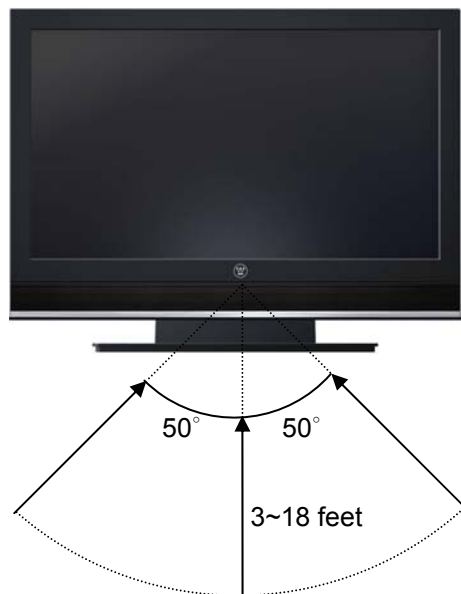

HDTV/ACCESSORY SETUP

Now that you're familiar with the basics of digital television and the various controls and connections for your HDTV, you're ready to enjoy its superb picture quality and sound, along with the ultimate convenience of connecting your game consoles, VCR, DVD, audio devices or personal computer.

NOTE: *If you have already performed the steps in the Quick Setup Menu, skip to the instructions specific to the accessory you want to connect.*

Connecting Your HDTV

Power

- Connect the supplied AC power cord to your HDTV's "AC In" jack and to a properly grounded AC outlet
 - If you're using an antenna or your cable service, connect the antenna or cable (not supplied) to the "Antenna" connector first
 - If you're using a satellite receiver, connect to either the "HDMI" or "Composite" connector (see page 17 for connector descriptions and locations)

Press the Power button on either the remote control or the side-mounted control panel to turn your HDTV on (it will take a few seconds to power up)

Determining Available Channels

- When connected to an antenna or cable source for the first time, you'll need to run "Autoscan"—it shall be available first time when you power on your TV

Or Choose Your TV Source

- Press the "Menu" button on your remote or the side panel to access the On Screen Display (OSD)
 - Use the right/left arrow buttons to scroll across to the "Setup" menu
 - Use the up/down arrow keys to select "TV" and "Quick Setup"
- Use the arrow keys to select your "Time Zone", which allows you to receive proper HDTV programming information
- Continue with arrow keys to select your signal source "Air/Cable/IRC/HRC"
 - If you use a rooftop or indoor antenna, select "Air"
 - If you use a cable service, select "Cable," "IRC" or "HRC" (depending on the frequency used by your cable service)
 - Press the left arrow key to start scanning for channels

NOTE: *Once the above process is completed, please exit OSD, press TV button to switch to regular TV input and repeat the above TV Quick Setup again for this input source.*

Connecting Your Personal Computer

Before making any connections, make sure all equipment is turned off.

Connection Types

- **VGA Connection**
 - Connect a 15-pin analog VGA cable (not supplied) from your computer's "VGA OUT" port to the HDTV's "VGA" port
 - Connect a stereo mini cable from your computer's "AUDIO OUT" port to the HDTV's "AUDIO IN" port
- **DVI-D Connection**
 - Connect a Digital DVI-HDMI cable (not supplied) from your computer's "DVI-D OUT" port to the HDTV's "HDMI" port
 - Connect a stereo mini cable from your computer's "AUDIO OUT" port to the HDTV's "AUDIO IN" port

Power

- Turn on your HDTV (wait a few seconds for it to power up)
- Turn on your computer
 - The HDTV will automatically adjust to the computer's resolution

Computer Settings

- For optimal picture quality, set timing mode of your computer's to recommended VESA™ (Video Electronics Standards Association) mode (see specifications of your purchased model from **APPENDIX**).
- Refer to your computer's graphic card User Guide for directions to set this timing mode.
- If using Microsoft Windows OS, please check its Display Properties.

Connecting Other Accessories

Following are the recommended connections to ensure optimal enjoyment of your accessory equipment with your HDTV.

Before making any connections, make sure all equipments are turned off.

DVD or Game System

- Connect your DVD player or gaming system using the Composite and Audio (Right/Left) connectors on the HDTV to (cable not supplied)
- You can also connect your DVD player using the HDTV's HDMI port (HDMI cable not supplied)

Video Cassette Recorder (VCR)

- Use the S-Video connector on your HDTV to connect your VCR (S-Video four-pin cable with round connector not supplied)
- You can also connect composite video to the HDTV's AV Jack

Cable or Satellite Receiver

- Connect your cable or satellite receiver using the HDTV's Composite and corresponding Audio (Right/Left) connectors
- You can also connect your cable or satellite receiver using HDTV's HDMI port (HDMI cable not supplied)

Audio Equipment

- Use your HDTV's "Audio Out" port to connect to an external audio device such as a headphone (cable not supplied)

HDTV OPERATION

About the On Screen Display (OSD)

Your HDTV's On Screen Display (OSD) conveniently integrates all functions required for setup and operation. There are two ways you can access the OSD—either by pressing the remote control's "Menu" button (located just below the volume controls on the left side of the remote), or by pressing the "Menu" button on the HDTV's right-side control panel. You can select amongst any of the three menus by using your remote's ▼/▲ buttons. Similarly, each of the menus includes sub-menus, which can be selected by using the remote's ▼/▲ and ► buttons. Once an item is selected, use ◀/▶ to make proper adjustment.

OSD Menus and Features

Settings Video Menu

The "VIDEO" menu allows you to adjust the properties of the picture you see on the screen by selecting one of the preset modes or adjusting brightness, contrast and sharpness individually. You can also adjust the color temp intensity, change output screen size (standard, fill, overscan) or advanced video functions and, if necessary, restore the factory default video settings.



Color Temp

The “Color Temp” of “VIDEO” menu provides a broad array of functions you’ll use during any color adjustments on the screen.



Color Temp Features	Feature/Sub-Menu Descriptions
Color Temp	Select one of preset picture mode or adjust each Red, Green and Blue color intensity individually.
Red	Adjust red color intensity
Green	Adjust green color intensity
Blue	Adjust blue color intensity

Audio Menu

The “AUDIO” menu let you precisely configure your audio preferences to optimize your listening experience.



Audio Menu Features	Adjustment Descriptions
Treble	Adjust high pitch audio tone
Bass	Adjust low bass audio tone
Balance	Adjust left and right speaker level
Digital Preference	Choose from one of three available sound tracks under DTV: <ul style="list-style-type: none"> • English • French • Spanish This feature only available under DTV and regular TV inputs and is content dependent.
MTS	Choose from three available MTS (Multi-Channel Television Sound) system under regular TV input : <ul style="list-style-type: none"> • Mono • Stereo • SAP This feature only available under DTV and regular TV inputs and is content dependent.
Reset	Reset all audio adjustments back to factory default

Setup Menu

The “SETTINGS” menu allows you setup some of the advanced features of this HDTV. These features include advanced Closed Caption, input source selection, OSD menu appearance, power management settings, TV system info, reset.



Channels Menu in DTV and TV inputs

The “CHANNELS” menu lets you easily setup your HDTV to watch the new digital broadcasting as well as regular TV content.



Quick Setup Menu	Selection Descriptions
Antenna	Select Air or Cable TV connection
Auto Scan	Find all of the available channel programs
Favorite A/B/C	Stored channels in Favorite buttons
Show/Hide	Channel is included in the channel list (show) Channel will not be displayed when scrolling through (hide)

Lock Menu in DTV and TV inputs

The “LOCK” menu allows you to set proper lock or unlock certain programs based on its ratings.



Lock Menu	Feature Descriptions
Change PIN	Type in the password. Default is 0000
System Lock	Turn On and off rating lock
Unrated Lock	Turn On and off parental control channels
USA	Enter USA parental control
Canada	Enter Canada parental control
RRT Setting	Enter and edit RRT setting table
Reset RRT	Reset RRT settings
Front Panel Lock	Enable or disable TV function key
Reset	Reset all adjustments back to initial settings

**For additional information on Parental Control functions, please see “About Parental Controls,” pages 33~36.*

Time Menu in DTV and TV inputs

The “TIME” menu allows you to set time related of this portable TV.



Settings Menu	Function Descriptions
Sleep Timer	Switch in between Off/15/30/60 Min
Time Zone	Select located time zone
DST	Turn on and off Daylight Saving
Auto Sync	Turn on and off automatic time synchronize
Clock	TV time display
Autowake	TV turn on or off time

About Parental Controls

The Parental Controls feature allows you to block TV programs based on various ratings systems, as well as to lock out the HDTV's right side-mounted controls. The first time you enter the "Parental Control" menu, you will be taken to the password sub-menu to set up your four-digit password, which is required for using this feature. You will be prompted to enter your selected password any time you wish to lock or unlock selected programming ratings or channels.



Parental Controls (USA)

Movie Rating menu allows you to lock or unlock programming according to the US MPAA rating system.



	Descriptions & Definitions
US MPAA Rating System	<ul style="list-style-type: none">• NR (Not available)• G (General audience)• PG (Parental guidance suggested)• PG-13 (Parents strongly cautioned)• R (Restricted)• NC 17 (No one 17 or under admitted)• X (Adult audience only)

US TV Ratings & Content

This sub-menu allows you to block programming according to US TV Ratings as well as content type.



US TV Ratings & Content Sub-Menu	
Rating	Definitions
TV-Y	Suitable for all ages
TV-Y7	Directed to older children (Unsuitable for children under 7)
TV-G	General audience
TV-PG	Parental guidance suggested
TV-14	Parents strongly cautioned (Unsuitable for children under 14)
TV-MA	Mature audience only (Intended for mature audiences ages 17 and older)
Content	Definitions
All	All Content
FV	Fantasy Violence
V	Violence
S	Sexual Situations
L	Adult Language
D	Sexually Suggestive Dialog

Parental Controls (CANADA)

This sub-menu allows you to block programming according to Canada TV Ratings as well as content type.



	Descriptions & Definitions
Canada Rating System	<ul style="list-style-type: none">• C (Suitable for children age under 8)• C8+ (Suitable for children ages 8 and over)• G (General audience)• PG+ (Parental guidance suggested)• 14+ (Intended for children ages 14 and over)• 18+ (Intended for viewers ages 18 and over)• EXEMPT (No rating will appear on screen)

APPENDIX: SPECIFICATIONS:

PT-16H120S High Definition LCD TV Specifications

Panel	Type	15.6" TFT (Thin Film Transistor), Active Matrix WXGA LCD, 1366 x 768 vertical stripe; anti-glare coating	
	Color	16.2 million colors	
	Aspect Ratio	16:9	
Viewing Angles		90° (H) / 60° (V)	
Input Signal	Video/Audio	HDMI-HDCP * 1 TV system NTSC / HDTV * 1 Composite * 1 / S-Video * 1 / RCA (L/R) stereo * 1	
Output Signal		3.5 mm Mini Stereo * 1	
HDTV Compatibility		480i, 480P, 720P, 1080i & 1080P	
PC Compatible	Recommended	1360 x 768 @ 60Hz	
	Supported	1024 x 768 @ 75Hz	640 x 480 @ 60, 75Hz
		1280 x 720 @ 60Hz	800 x 600 @ 60, 75Hz
		1366 x 768 @ 60Hz	
Speaker Output		3.5W (x2 Channels)	
Power	Voltage	100~240AC, 50~60Hz, 1.6A	
Temperature	Operating	+5° ~ +35° (Hum 20~80%)	
	Storage	-20 ~ +55° (Hum 20~ 85%)	
Humidity (Relative)	Operating	20~ 80% non-condensing.	
	Storage	20~ 85% non-condensing.	
Altitude	Operating	0 to 2,000 m	
	Storage	0 to 12,000m	
Dimensions	Physical	15.2"(W) x 12.5"(H) x 7.1"(D) (with Base) 15.2"(W) x 12.5"(H) x 3.8"(D) (w/out Base)	
Weight		6.2 lbs. (with Base) 5.7 lbs. (w/out Base)	
Regulations		UL/C-UL, FCC-B, EPA	
Power saving	On	<60W Typical (White LED)	
Modes	Active Off	<1W (Blinking LED)	
Warning: Do not set the graphics card in your computer to exceed these refresh rates Note: Product Specifications are subject to change without notice.			

PT-19H140S High Definition LCD TV Specifications

Panel	Type	19" TFT (Thin Film Transistor), Active Matrix WXGA LCD, 1680 x 1050 vertical stripe; anti-glare coating	
	Color	16.2 million colors	
	Aspect Ratio	16:10	
Viewing Angles		170° (H) / 160° (V)	
Input Signal	Video/Audio	RGB Analog * 1 (75 ohms, 0.7 Vp-p)/Mini-Stereo * 1 - H/V separated (TTL) for PC - fh: 30-80 kHz, fv: 50-75 Hz NTSC HDMI-HDCP * 1 TV system NTSC / HDTV * 1 Composite * 1 / S-Video * 1 / RCA (L/R) stereo * 1	
Output Signal		3.5 mm Mini Stereo * 1	
HDTV Compatibility		480i, 480P, 720P, 1080i & 1080P	
PC Compatible	Recommended	1680 x 1050 @ 60Hz	
	Supported	1024 x 768 @ 75Hz	640 x 480 @ 60, 75Hz
		1280 x 800 @ 60Hz	800 x 600 @ 60, 75Hz
		1440 x 900 @ 60Hz	
Speaker Output		3.5W (x2 Channels)	
Power	Voltage	100~240AC, 50~60Hz, 1.6A	
Temperature	Operating	+5° ~ +35° (Hum 20~80%)	
	Storage	-20 ~ +55° (Hum 20~ 85%)	
Humidity (Relative)	Operating	20~ 80% non-condensing.	
	Storage	20~ 85% non-condensing.	
Altitude	Operating	0 to 2,000 m	
	Storage	0 to 12,000m	
Dimensions	Physical	17.9"(W) x 15.5"(H) x 7.1"(D) (with Base) 17.9"(W) x 15.5"(H) x 4.0"(D) (w/out Base)	
Weight		8.7 lbs. (with Base) 7.8 lbs. (w/out Base)	
Regulations		UL/C-UL, FCC-B, EPA	
Power saving	On	<75W Typical (White LED)	
Modes	Active Off	<1W (Blinking LED)	
Warning: Do not set the graphics card in your computer to exceed these refresh rates			
Note: Product Specifications are subject to change without notice.			

PT-19H520S High Definition LCD TV Specifications

Panel	Type	19" TFT (Thin Film Transistor), Active Matrix WXGA LCD, 1440 x 900 vertical stripe; anti-glare coating	
	Color	16.2 million colors	
	Aspect Ratio	16:10	
Viewing Angles		170° (H) / 160° (V)	
Input Signal	Video/Audio	RGB Analog * 1 (75 ohms, 0.7 Vp-p)/Mini-Stereo * 1 - H/V separated (TTL) for PC - fh: 30-80 kHz, fv: 50-75 Hz NTSC HDMI-HDCP * 1 TV system NTSC / HDTV * 1 Composite * 1 / S-Video * 1 / RCA (L/R) stereo * 1	
Output Signal		3.5 mm Mini Stereo * 1	
HDTV Compatibility		480i, 480P, 720P, 1080i & 1080P	
PC Compatible	Recommended	1440 x 900 @ 60Hz	
	Supported	1024 x 768 @ 75 Hz	640 x 480 @ 60, 75Hz
		1280 x 800 @ 60Hz	800 x 600 @ 60, 75Hz
Speaker Output		3.5W (x2 Channels)	
Power	Voltage	100~240AC, 50~60Hz, 1.6A	
Temperature	Operating	+5° ~ +35° (Hum 20~80%)	
	Storage	-20 ~ +55° (Hum 20~ 85%)	
Humidity (Relative)	Operating	20~ 80% non-condensing.	
	Storage	20~ 85% non-condensing.	
Altitude	Operating	0 to 2,000 m	
	Storage	0 to 12,000m	
Dimensions	Physical	18.6"(W) x 16.5"(H) x 6.6"(D) (with Base)	
		18.6"(W) x 14.7"(H) x 3.4"(D) (w/out Base)	
Weight		9.7 lbs. (with Base) 9.0 lbs. (w/out Base)	
Regulations		UL/C-UL, FCC-B, EPA	
Power saving	On	<75W Typical (Blue LED)	
Modes	Active Off	<1W (Orange LED)	
Warning: Do not set the graphics card in your computer to exceed these refresh rates			
Note: Product Specifications are subject to change without notice.			

Troubleshooting

No Power

- Make sure power cord is securely connected to the “AC In” jack on the back of the High Definition LCD TV.
- Make sure AC power cord is securely connected to the AC socket.
- Plug another electrical device (such as a radio) to the power outlet to verify that the outlet is supplying the proper voltage.

Power is suddenly turned off

- Check if Sleep Timer is set. If so, turn it off.

Remote Control Does Not Work

- Press only one button at a time.
- Point remote control closer and directly to the IR sensor.
- Make sure batteries are inserted correctly.
- Replace batteries with new ones if necessary.

Remote Control Code Not Found in a “Universal” Remote

- Purchase a separate “learning” remote control.
- Go to www.wde.com for a list of remote codes.

Image Quality Issues

- For the best TV image quality, “Standard Definition” TV content should be viewed in Standard display format.

No Picture

- Check the video connection.
- Make sure the video cable connected to the High Definition LCD TV is tightly secured to the video output port on the back of the computer or any attached audio/video apparatus. If the other end of the video cable is not attached permanently to the High Definition LCD TV, secure it tightly.
- Adjust brightness and backlight.
- Make sure that the input source you are connected to correspond to the source on the High Definition LCD TV.
- Verify that the antenna is properly connected.

No Picture when I connect VGA cable or “No Input Signal”

- Check VGA cable connection.
- Lower the video resolution on the computer and try plugging in the cable again.

Picture is cut off/with sidebar screen.

- Use “Auto Adjust” in PC mode
- Make sure the aspect ratio is set correctly.

Blocky images appear in TV mode.

- Check your antenna connection. If necessary, rotate the antenna and wait up to 10 seconds for signal.
- Reduce signal splitters and excessively long cables.
- Replace poor antenna cables and/or connectors to improve signal quality.

Wrong or Abnormal Colors

- If any colors (red, green or blue) are missing, check the video cable to make sure it's securely connected. Loose or broken pins in the cable connector could cause an improper connection.
- Connect the High Definition LCD TV to another computer.

Snow Appears on Screen

- Check your antenna connection. If necessary, rotate the antenna.
- Make sure the external device is HDCP compliant.

AUDIO Interconnection Issues

- Remember—S-Video and Composite AV1 share the same audio source.

There's No Sound

- Check the audio connection.
- If MUTE appears on the screen, press the “MUTE” button on the remote control to turn the function off.
- Check the audio settings to see if the HDTV audio is set to SAP or minimum.
- Press the Volume + (Up) key on the remote control.

Parental Control Password is “LOST”

- While rare, if this should happen, select “PASSWORD EDIT” and enter “0000” to reset the password.

Where Can I Find More Help?

- Log on to: www.wde.com
- Contact Westinghouse Customer Service at (866) 287-5555 or write us at service@wde.com

Cleaning the High Definition LCD TV

- **MAKE SURE THE HIGH DEFINITION LCD TV IS TURNED OFF**
- **NEVER SPRAY OR POUR ANY LIQUID DIRECTLY ONTO THE SCREEN OR CASE**

To clean the screen:

1. Wipe the screen with a clean, soft lint-free cloth. This removes dust and other particles.
2. If still not clean, apply a small amount of non-ammonia, non-alcohol based glass cleaner onto a clean, soft lint-free cloth and wipe the screen.

To clean the case:

1. Use a soft, dry cloth.
2. If still not clean, apply a small amount of non-ammonia, non-alcohol based, mild non-abrasive detergent onto a clean, soft lint-free cloth, then wipe the surface.

Disclaimer

Westinghouse Digital Electronics does not recommend the use of any ammonia or alcohol-based cleaners on the High Definition LCD TV screen or case. Some chemical cleaners have been reported to damage the screen and or High Definition LCD TV case. Westinghouse Digital Electronics will not be liable for damage resulting from use of any ammonia or alcohol-based cleaners.

Wall Mounting (Optional)

To obtain a wall-mounting kit, contact your local dealer, Refer to the instructions that come with the base mounting kit.

For PT-16H120S High Definition LCD TV

Screw holes (100 mm X 100 mm)

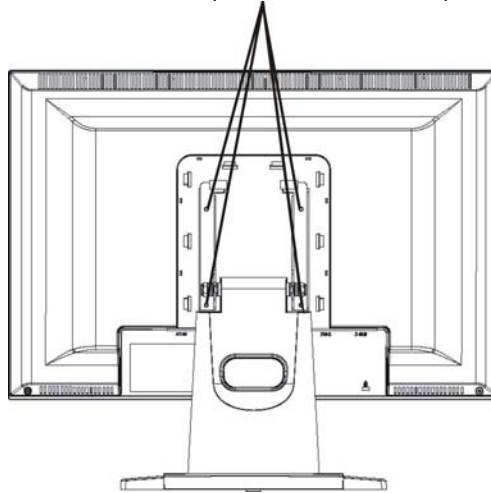

* Note: Please use UL Listed wall mount bracket with M4 mm x 12 mm (L) screw for application.

For PT-19H140S High Definition LCD TV

Screw holes (100 mm X 100 mm)

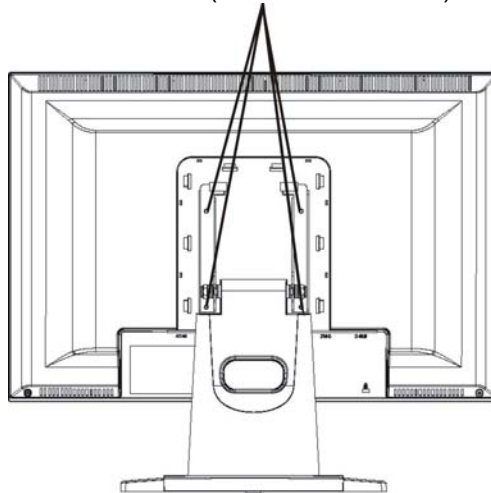

* Note: Please use UL Listed wall mount bracket with M4 mm x 10 mm (L) screw for application.

For PT-19H520S High Definition LCD TV

Screw holes (100 mm X 100 mm)

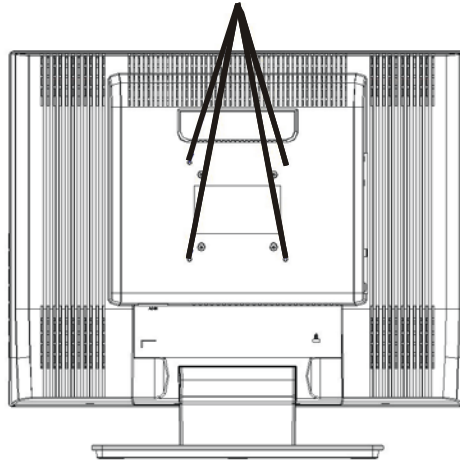

* Note: Please use UL Listed wall mount bracket with M4 mm x 12 mm (L) screw for application.