

# *ThermoView Ti30*

## User's Manual

July 1, 2003  
Version 1.0

# CONTENTS

Introduction.....	7
Quick Specifications Table.....	8
<b>Chapter 1 Unpacking Your New Imager .....</b>	<b>9</b>
First, the Batteries .....	10
Charging the Rechargeable Battery Pack .....	12
Normal Charge Cycle .....	12
<b>Chapter 2 Getting Started.....</b>	<b>14</b>
Attaching the Wrist Strap.....	14
Turning the Unit On.....	15
Displaying Images .....	15
Settings and Controls .....	18
Keypad .....	18
Laser On/Off Toggle Button.....	20
Centigrade/Fahrenheit Toggle Button.....	22
LCD Backlight Illumination Switch .....	22
Palette Switch.....	22
Measurement Mode Switch .....	22
Gain and Level Thumbwheels .....	23
Focus Wheel.....	23
Trigger.....	24
Man Machine Interface Flow Charts .....	25
Main Loop.....	25
Image Recording Procedure.....	26
Emissivity Adjustment Procedure.....	26
Reflected Temperature Compensation Adjustment Procedure.....	27
Recall Images Procedure.....	27
Quick Image Fix Procedure .....	28
Array Recalibration Procedure .....	28
Recording an Image .....	28
Retrieving an Image.....	29
<b>Chapter 3 Downloading and Looking at Images .....</b>	<b>30</b>
Installing the Software .....	30
Connecting the Docking Station to Your Computer.....	31
Hooking Up the Docking Station.....	31
Downloading Images .....	34
Saving Images.....	35
Setting the Imager Clock .....	36
Field USB Port.....	38



Looking at Your Downloaded Images.....	38
<b>Chapter 4 Obtaining the Best Image .....</b>	<b>41</b>
The Importance of Focusing .....	41
Selecting the Color Palette.....	42
Selecting the Measurement Mode.....	42
Gain and Level Thumbwheels .....	45
<b>Chapter 5 Qualitative and Quantitative Temperature Measurements 46</b>	
Distance to Target (Spot) Ratio .....	46
D:S ratio: $D / S = 90$ .....	47
Optical Diagram.....	47
Field-of-View.....	47
Environmental Conditions .....	48
Ambient Temperatures.....	48
Emissivity .....	49
Reflected Temperature Compensation.....	49
<b>Chapter 6 Organizing Your Data.....</b>	<b>51</b>
File Management .....	51
Uploading Data to the Imager.....	52
<b>Chapter 7 Analyzing Your Data.....</b>	<b>55</b>
The Single Image Screen .....	55
Scale Limits .....	55
Isotherms.....	57
Additional Image Analysis Tools .....	58
The Temperature Table Tab.....	58
The Profile Tab .....	59
The Histogram Tab .....	60
The Menu Bar .....	61
File .....	61
Temperature Scale .....	62
Palette.....	62
Image.....	63
Window.....	64
Help.....	64
Reporting Your Findings .....	65
<b>Appendix A - Technical Reference.....</b>	<b>66</b>
Imager Accuracy Chart .....	66
Imager Reading Error vs Source D:S.....	67
Typical Emissivity Values .....	67



**Appendix B – Infrared Theory Q&A..... 71**

**Glossary ..... 75**



© 2003 Raytek Corporation.

The information contained in this document is subject to change without notice.

Raytek and the Raytek logo are registered trademarks and ThermoView and InsideIR are trademarks of Raytek Corporation. Windows is a registered trademark of Microsoft Corporation in the United States and/or other countries. Pentium is a registered trademark of Intel Corporation or its subsidiaries in the United States and other countries. All other trademarks are the property of their respective holders.

## ***Warranty Information***

Raytek warrants this product to be free from defects in material and workmanship under normal use and service for a period of one year from date of purchase, except as hereinafter provided. This warranty extends only to the original purchaser (a purchase from Raytek or Raytek-licensed distributors is an original purchase).

The warranty shall not apply to any product that has been subject to misuse, neglect, accident, or abnormal conditions of operation or storage. In the event of failure under warranty, return this product to the distributor or retailer from whom it was purchased for replacement or repair at manufacturer's discretion. Purchaser's exclusive remedy under warranty shall be replacement, repair, or refund of the purchase price. This warranty shall not apply to batteries.

The foregoing warranty is in lieu of all other warranties, expressed or implied, including but not limited to any implied warranty of merchantability, fitness, or adequacy for any particular purpose or use. Raytek shall not be liable for any special, incidental, or consequential damages, whether in contract, tort, or otherwise.



## ***Customer Service Contact Information***

**Instrumentation Systems & Services Ltd**  
P.O. Box 1  
ILKLEY  
West Yorks  
LS29 9QE UK

---

July 1, 2003

- 6 -

Version 1.0



**Tel: (01943) 602001- [WWW.ISSLTD.CO.UK](http://WWW.ISSLTD.CO.UK) - Fax: (01943) 816796**



## **Introduction**

The Raytek ThermoView™ Ti30 imager is a state-of-the-art, lightweight, gun-grip style thermal imaging unit that lets you obtain instant and accurate thermal images and radiometric readings at a remote distance from your target. Ergonomically designed for either left or right-handed use, the ThermoView imager captures thermal images and data with a simple click of the trigger. The unit can store up to 100 images that can then be downloaded to your personal computer where the images can be stored, evaluated further or added to reports and presentations.

The ThermoView's docking station allows effortless connection to a host computer, and offers rapid data downloading and uploading. The docking station also automatically recharges the (rechargeable) batteries when the unit is not in use.

The companion software application, InsideIR™, included with the imager lets you display, examine, and analyze your images and data to discover qualitative and quantitative trends associated with the target. InsideIR software allows you to define maintenance databases based on your specific equipment condition, monitoring, and asset management needs.

The ThermoView imager contains 100 image storage locations that can also be predefined with unique equipment data and parameters. Notes and comments can also be included for the technician performing the given maintenance routine. Maintenance reports and follow-up actions can be created quickly and accurately using information carried over from image files. Reports can be easily printed or sent electronically.

Using the ThermoView imager's structured database, maintenance professionals can ensure consistent, repeatable measurements over time. They can efficiently and accurately communicate with co-workers, management, equipment manufacturers, and service providers by incorporating thermal images in emails and reports. In addition, customers can easily create permanent inspection records indicating temperature behavior before and after repairs, and monitor thermal trends over long periods.

We are confident the ThermoView Ti30 imager is both an easy-to-use, yet powerful, thermal imaging tool on the market today. We know you will find it a valuable and indispensable tool for your workplace and for your professional growth.



## Quick Specifications Table

Thermal	Thermal Measurement Range	0 to 250°C (32 to 482°F)
	Accuracy	±2% or ±2°C, whichever is greater at calibration geometry and 25°C
	Repeatability	±1% or ±1°C, whichever is greater
	NETD	250 mK
	Temperature Indication Resolution	0.1 (°F or °C)
Optical / IR	Spectral Range	7-14 microns
	Target Sighting	Single Laser Dot (Meets IEC Class 2 & FDA Class II requirements)
	Optical Resolution	90:1
	Minimum Diameter Measurement Spot	7mm (0.27") at 60cm (24")
	Image Frame Rate	20Hz
	Field of view (FOV)	17° Horizontal x 12.8° Vertical
	Instantaneous Field of view (IFOV)	1.9mrad
Controls	Focus	Focusable, 61 cm / 24" to infinity
	Temperature Scale	°C or °F selectable
	Palettes	Gray, Ironbow, or Rainbow selectable
	Measurement Modes	Automatic, Semi-Automatic, or Manual selectable
	Laser On/Off	✓
	Gain Control	✓
	Level Control	✓
	LCD Backlight	Bright, Dim, Off selectable
Operational	Adjustable Emissivity (0.10 to 1.00 by 0.01)	✓
	Display Type	Liquid Crystal Display - TFT technology optimized for both indoor and outdoor use
	Reflected Background Temperature	-50 to 460°C (58 to 860°F)
	Ambient Operating Temperature	0 to 50°C (32 to 122°F)
	Relative Humidity	10 to 90% Non-condensing
	Storage Temperature	-25 to 70°C (-13 to 158°F) [without batteries]
	Storage Capacity	∞/∞/∞ *O* * *▲
	Laser On Icon	✓
	Low Battery Icon	✓
	Palette Icon	✓
	Measurement Mode Icon	✓
	Thermal Analysis Software	InsideIR (included)
	PC Software Operating Systems	Microsoft® Windows® 98, Windows 2000 or Windows XP
Electrical	Power	6 AA batteries(not included) or rechargeable battery pack (included)
	Battery Life	Min. 5 hours continuous use
	Data Transfer	USB interface, total transfer time up to 30s for 100 pictures
	Storage Device	Flash Memory
Other	Tripod Mount (6.35 mm (1/4) 20 unc threading)	✓
	Weight (includes batteries)	1kg (2.2 lb)
Accessories / Options	Standard Accessories	<ul style="list-style-type: none"> <li>• Multi-language Interactive Manual (CD ROM)</li> <li>• InsideIR Software</li> <li>• Docking station with Universal Power Adapter and USB Connection</li> <li>• Hardshell Carry Case</li> <li>• USB Computer Cable</li> <li>• Rechargeable and Non-rechargeable Battery Packs (batteries not included)</li> <li>• Multi Language Thermography Training Presentation (CD ROM)</li> <li>• Carrying Pouch</li> <li>• Wrist Strap</li> <li>• Quick Reference Card</li> </ul>
	Options	NIST Calibration certificate





# Chapter 1 Unpacking Your New Imager

Begin by opening the shipping box. Be sure to save the box and shipping materials in the event you need to ship the imager.

In the shipping box, you will find a hard carrying case, containing the following items:

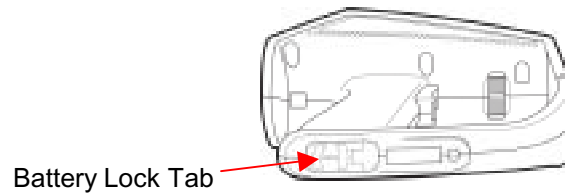
- 1 ThermoView Ti30 Imager
- 1 ThermoView Imager Docking Station
- 1 Universal power supply and plug adapters
- 1 CD ROM containing multi-language training materials
- 1 CD ROM containing InsideIR™ software and multi-language interactive manual
- 1 Quick Reference Card
- 1 Carrying pouch and 1 Wrist Strap
- 1 USB Cable
- 1 rechargeable battery pack
- 1 battery pack for 6 AA non-rechargeable batteries (batteries not included)



## ***First, the Batteries***

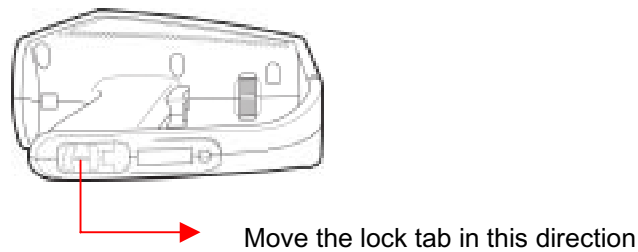
The battery compartment is located in the handle of the unit.

The unit is shipped with an empty battery pack for non-rechargeable batteries installed in the battery compartment.

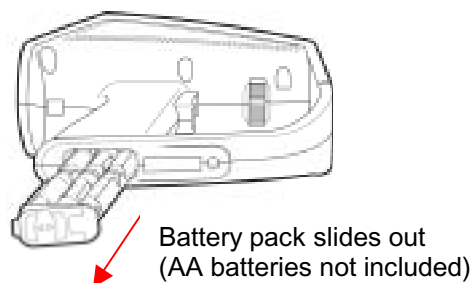


Remove the empty battery pack from the battery compartment.

The battery pack can be removed by sliding the lock tab towards the trigger.

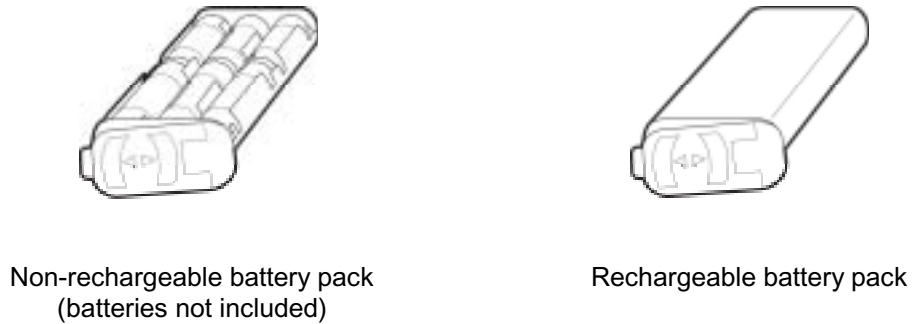


Once the lock is released, the battery pack will slide down. Tilt the top of the unit up to slide the battery pack out.



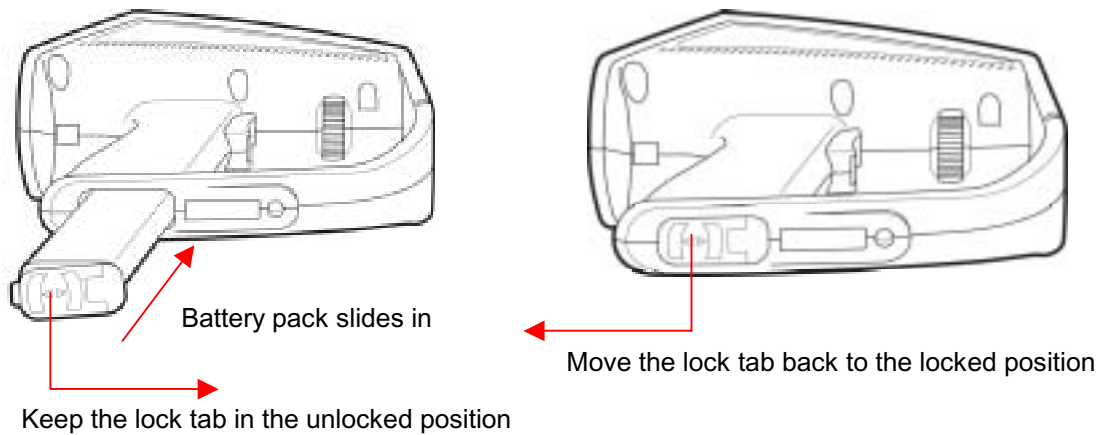
**Figure 1. Removing the Battery Pack**

At this point, you have two options: insert six new AA batteries into the empty non-rechargeable batteries pack or replace it with the supplied rechargeable battery pack. You will notice the difference between the two battery packs as shown in Figure 2 below:



**Figure 2. Battery Packs**

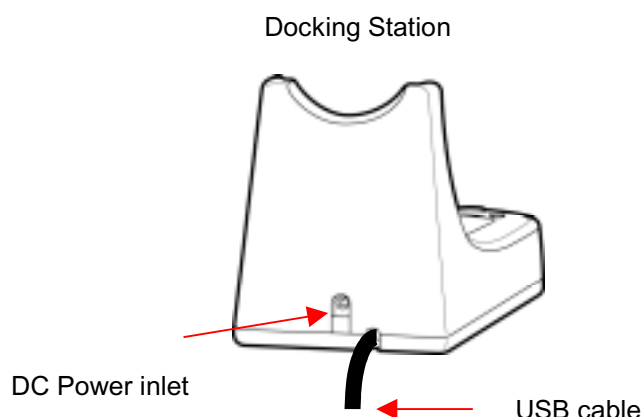
To replace the battery pack just slide it back in, making sure the plastic tab lock is in the unlocked position (to the right of the pack). Use the rails on battery pack as guides. Once it is inserted, slide the lock tab back into the locked position as shown below in Figure 3.



**Figure 3. Installing Batteries**

## Charging the Rechargeable Battery Pack

Connect the docking station to a power outlet using the supplied universal power adapter. Be sure to use the plug adapter that fits your local electrical standards. Connect the power jack of the power adaptor to the DC power inlet located on the docking station.



### Normal Charge Cycle

- With the ThermoView unit powered off, place it on the docking station.
- Do not connect the USB cable to the computer at this point.
- The red LED (on the left) will flash several times as the circuit senses a rechargeable battery pack and determines its state of charge.

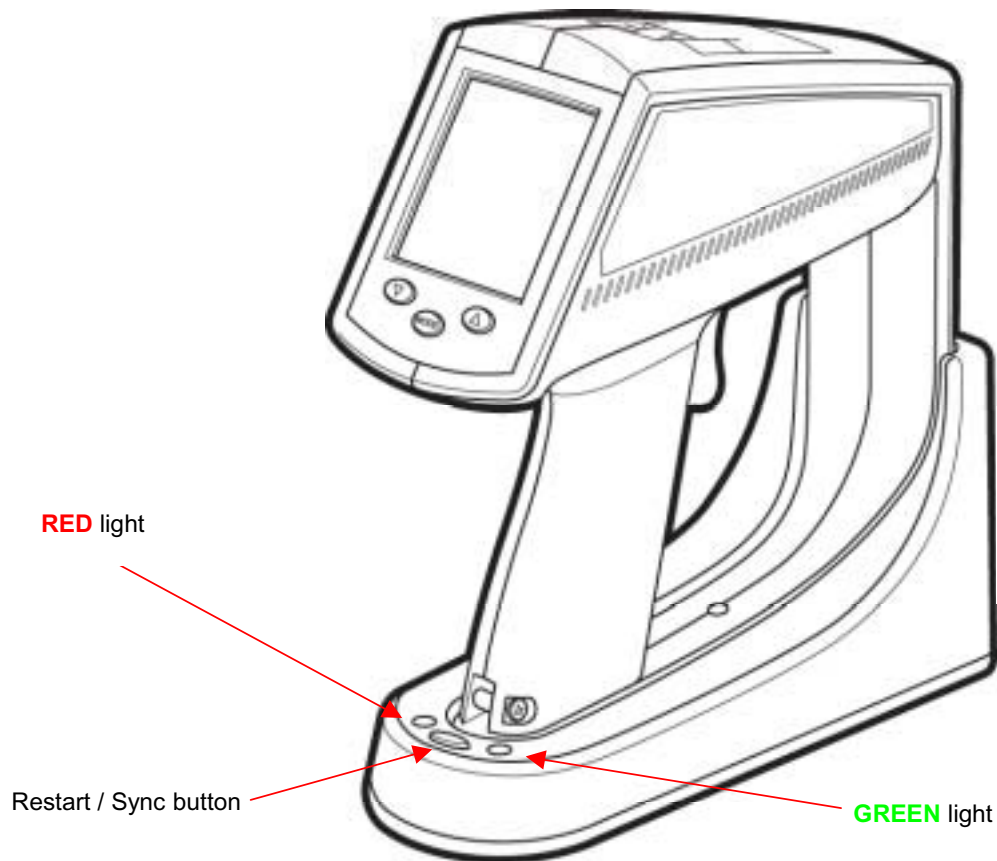
**Note:** If a non-rechargeable battery pack is sensed by the docking station, neither LED will blink.

The remaining points assume that the imager contains a sealed, rechargeable battery pack.

- The red LED turns on continuously to indicate that charging is in progress. This process can take from a few minutes to more than an hour.
- The red LED turns off once the battery pack is fully charged and the green LED (on the right) turns on continuously.
- Momentarily lifting the ThermoView unit from the docking station for about 5 seconds or longer interrupts the charging process. The green light will come on and no further charging will occur. Press the **Restart / Sync** button between the LEDs to resume charging. Pressing the button if the batteries are completely charged will have no effect.
- The imager may be removed from the docking station before recharging is completed without harm. However, the imager may not be fully charged and its operating time may be reduced accordingly.
- An imager containing single-use batteries may safely be placed on the docking station for storage or image transfer. In fact, we recommend the imager always be placed on the docking station when not in use.



A charge cycle takes a rechargeable battery pack from whatever level of charge it presently has and brings it to a fully charged condition. The charger will not over-charge a battery pack no matter how many times the button is pushed.



**Figure 4. Docking Station LED Indicators**

**Note:** You may download stored images from the ThermoView imager to a personal computer if the docking station's USB cable is connected to a computer running the InsideIR software. Press the **Restart / Sync** button to transfer stored images to the computer (see Chapter 3 Downloading and Looking at Images for details). Pressing the **Restart / Sync** button also starts the charging cycle.

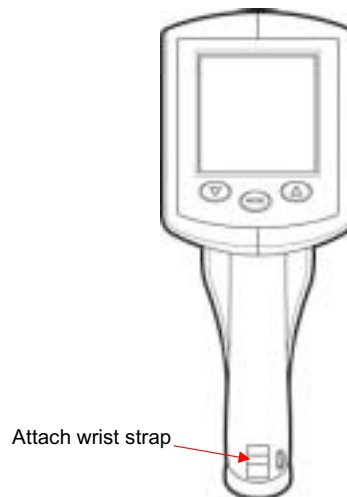
Once the batteries are charged, you are ready to begin taking thermal images and temperature measurements. Take a moment now to read the next section and become acquainted with the basic features and controls of the imager.

## Chapter 2 Getting Started

Your ThermoView imager has settings and capabilities that let you customize its operation for the task at hand. The following section describes each setting on the imager.

### ***Attaching the Wrist Strap***

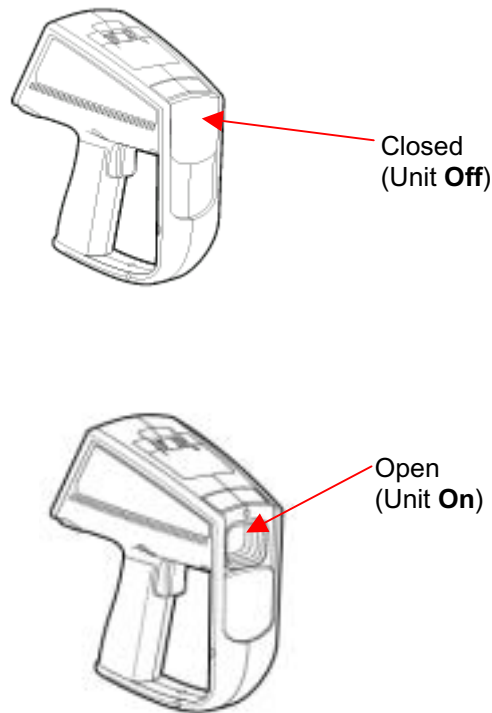
Your ThermoView imager comes with a wrist strap, which can be attached by clipping the metal part of the strap to the small metal bar at the base of the imager (see Figure 5 below).



**Figure 5. Attaching the Wrist Strap**

## Turning the Unit On

Power is switched on or off by opening or closing the lens door. Sliding down the lens door turns the imager on (see Figure 6 below). Slide the door up to turn off the imager.



**Figure 6. Powering the ThermoView Imager On and Off**

**Note:** The unit is self-protected against excessive levels of infrared radiation and it will cause the unit to automatically shut down. If that happens, slide the lens door closed, wait a minute and slide it open again.

**Important:** Always dock the imager in the docking station when not in use. By doing so, you will assure the batteries will be always fully charged when using the rechargeable battery pack. The image will not show thermal images or respond to controls while it is in the docking station.

## Displaying Images

The ThermoView imager performs an initial auto-check each time it is activated and then immediately shows the **Information Screen**. The **Information Screen** displays the following information about the ThermoView imager unit:

- Unit Serial Number
- Date and Time (configured by the user through the software)
- Tag name is the name of the user-defined folder from which data was uploaded through the software. Useful tag names are department names or area associated with the unit. This space is blank until configured by the user.
- Station is the name of the networked computer associated with a specific unit. This is blank until configured by the user.
- Palette is the type of palette currently selected
- Firmware revisions
- Icons for LCD illumination, palette type, measurement mode and laser status

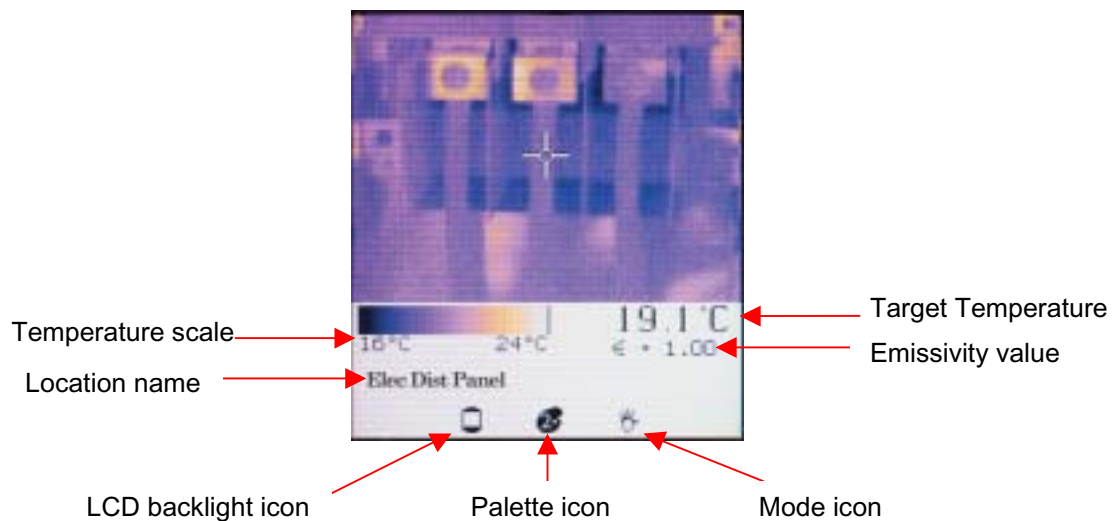


**Figure 7. The Information Screen**

Press the **MODE** button to exit the **Information Screen**. (Refer to Figure 9, the **MODE** button is located center, below the LCD screen.) The ThermoView imager immediately goes into measurement mode, showing a real time thermal image of what is in front of the lens. A reticle with a crosshatch at the center of the display shows the temperature spot.

**Note:** Do not change any of the settings yet. User configurable parameters will be explained later in Figure 31.





**Figure 8. Normal Mode**

Take time to experiment with the imager and become familiar with how the thermal image is updated on the display as you aim the imager at different targets with different thermal patterns. Notice how images display in varying colors, which are related to the different target temperatures. The color scale at the bottom of the thermal image shows the minimum and maximum temperature value in the thermal scene at any moment. These values will change as you point the imager at other targets, or if the temperatures of the current target change. The sequence or progression of different colors along the color scale indicates the distribution of the different temperatures on the thermal scene. Notice how the colors along the beginning of the color scale represent lower temperatures and colors along the end of the color scale represent higher temperatures.

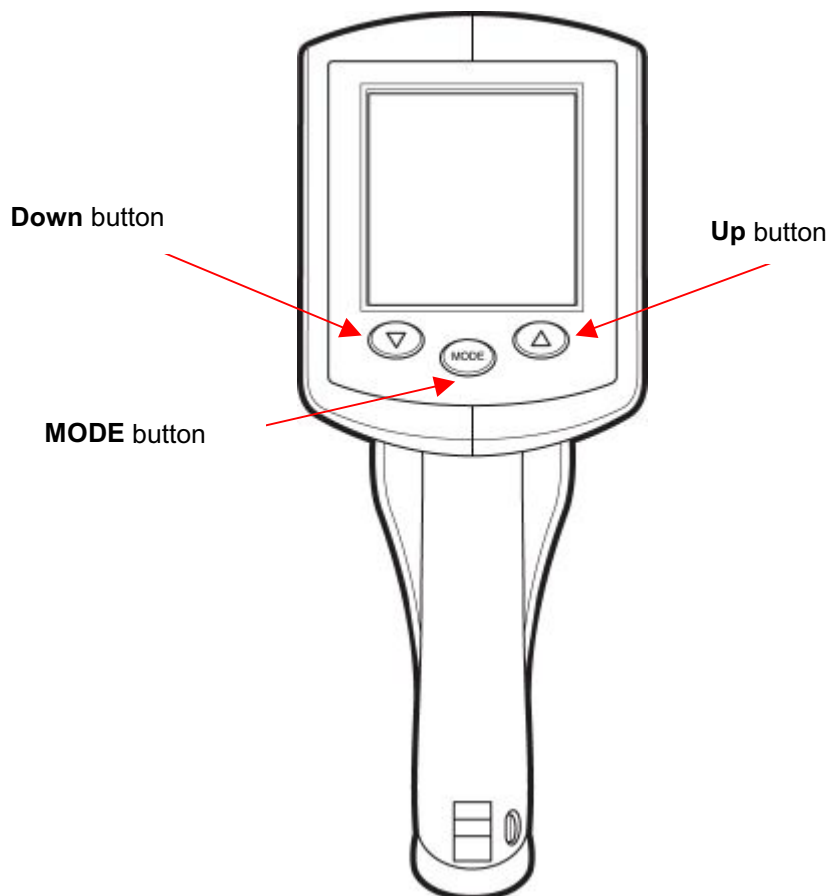
**Note:** At this point you probably have noticed that the image freezes briefly from time to time while an hourglass icon is briefly displayed. This is a normal process that happens when the unit momentarily shuts down the optical channel to eliminate offset errors. This is a recalibration sequence that begins immediately after the unit is turned on. Recalibration occurs at 5 seconds, then 10 seconds, then 20 seconds, then 30 seconds and then finally at every other minute. It is a good idea to keep the unit **On** if you are using it constantly over a period of time to avoid resetting the recalibration procedure counter.

The ThermoView imager settings can be customized for your particular application. The following sub-section reviews the settings and controls.

## Settings and Controls

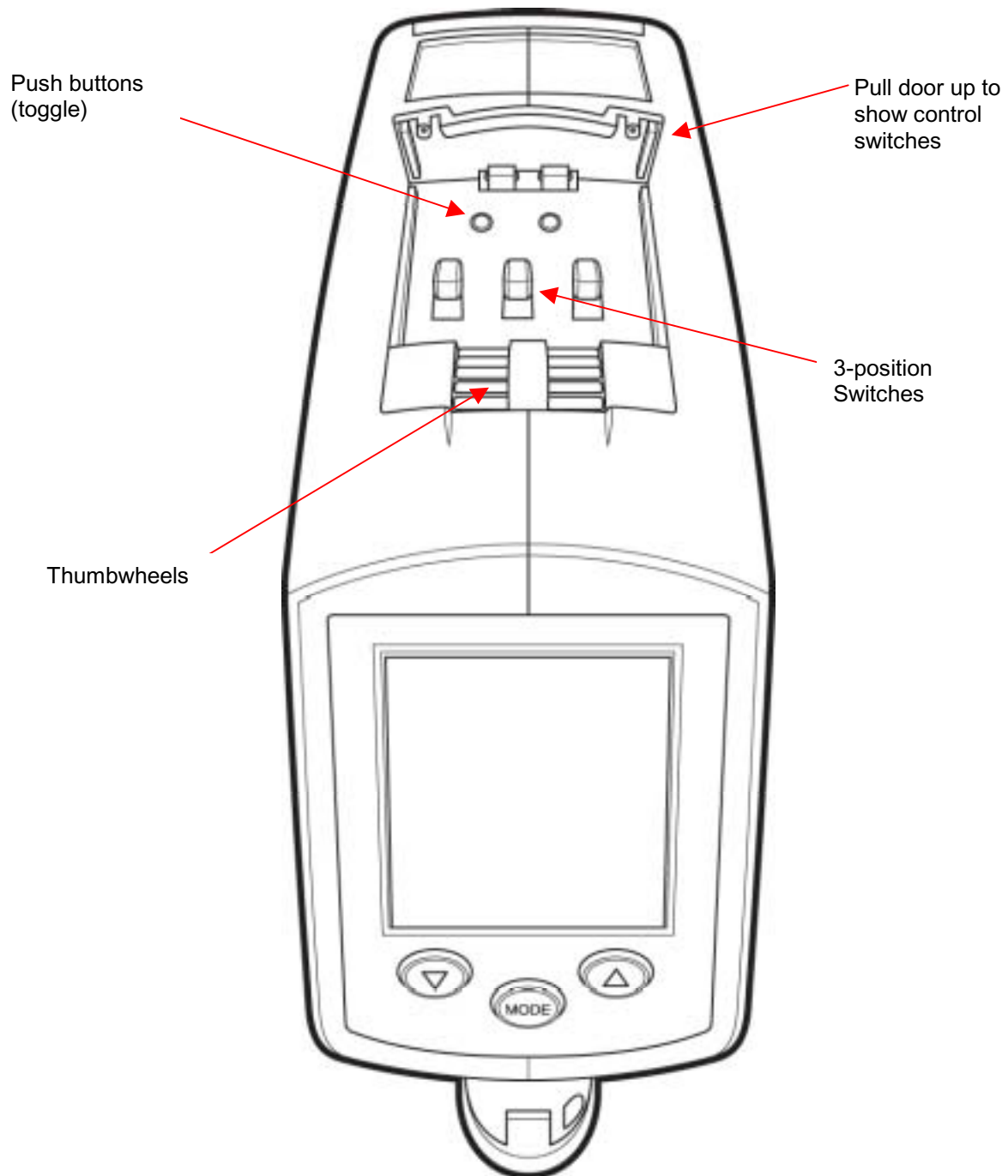
### Keypad

Three buttons located below the LCD screen allow you to select operation modes and change parameter values. These buttons are the **MODE** button, the **Up** button, and the **Down** button. The **Up** and **Down** buttons are used mostly to increment and decrement parameter values. They activate some special functions as well. The **MODE** button is used mostly to cycle between the different operations. Details about the function of each button are discussed later.



**Figure 9. Keypad Controls**

A hinged door on the top surface of the ThermoView imager hides five switches that allow you to change the basic imager settings. Open the hinged door by lifting it up.



**Figure 10. ThermoView Imager Settings Switches (icons not shown)**

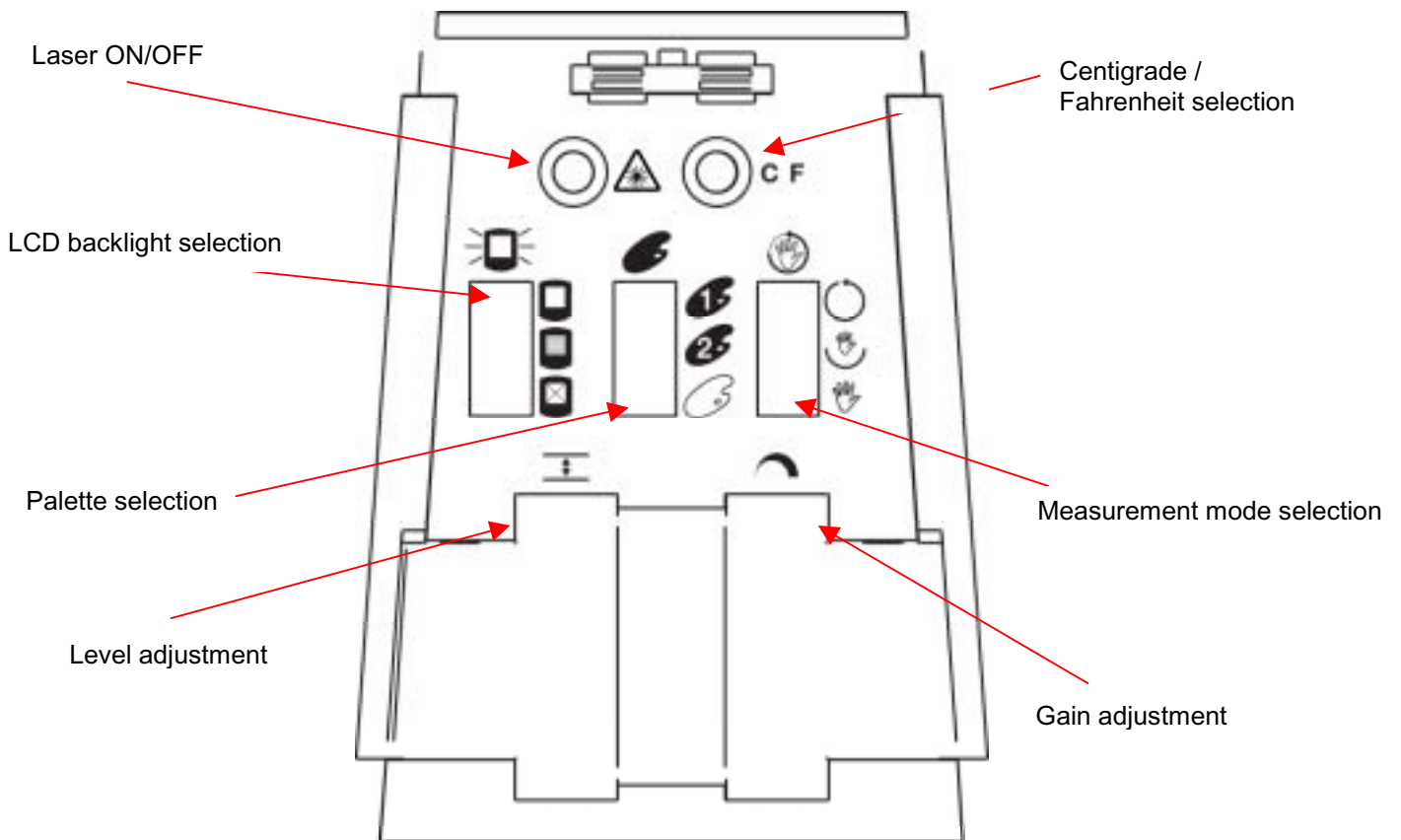
The illustration below shows the top view of the switch bay without the door. There is an icon printed near each switch and near each switch position indicating the function of each switch and switch position. These functions are explained in the next paragraphs.

July 1, 2003

- 19 -

Version 1.0

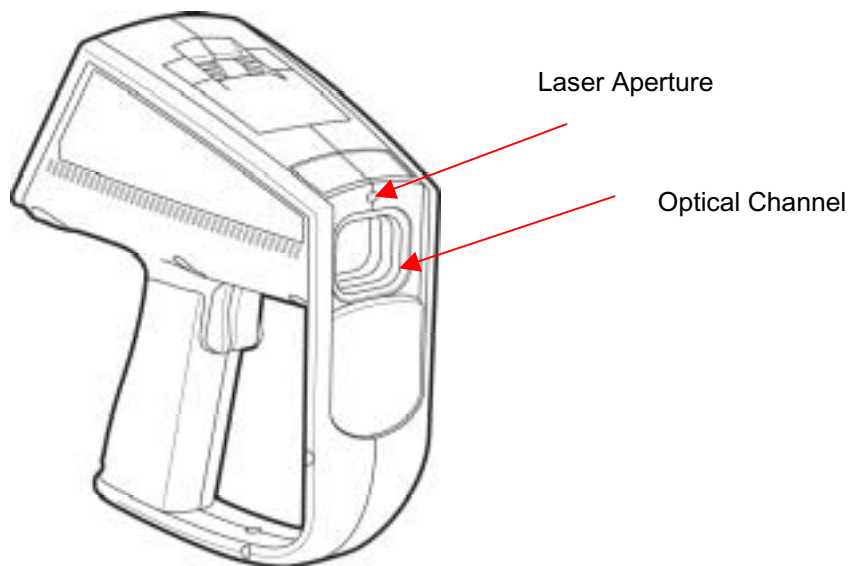




**Figure 11. ThermoView Imager Settings Switches**

### ***Laser On/Off Toggle Button***

The **Laser On/Off** toggle button switches the laser on and off. By default, the guiding laser beam is off. Depending on the situation you may or may not need the laser guidance beam.



**Figure 12. Laser Aperture and Optical Channel**

**Note:** The laser is only a sighting aid. It is not required to take measurements. The laser is not coaxial with the infrared channel, thus the laser dot is offset from the center of the thermal image. The laser dot is not visible in the thermal image.

**Important:** Avoid directing the laser to people's eyes. See important safety information on the warning laser label located on the side of the unit. There are different laser warning labels for different geographic regions. These are identified below.



**North America**



**Europe / Latin America**



**Japanese**



**Chinese**

**Figure 13. Laser Warning Labels For Different Geographic Regions**

## ***Centigrade/Fahrenheit Toggle Button***

**Centigrade/Fahrenheit** button toggles the displayed temperature data in either Centigrade or Fahrenheit temperature scales. The factory default is Centigrade.

## ***LCD Backlight Illumination Switch***

**LCD Backlight Illumination** switch provides three backlight illumination levels as shown below.



**Off**



**Medium**






**Full**

**Full** brightness is recommended for indoor use; use **Medium** brightness to save battery life, and set backlight **Off** for outdoor applications. The default position is **Full** brightness.

## ***Palette Switch***

The **Palette** switch allows the ThermoView imager to display temperature patterns in three different palettes as indicated below:

- Rainbow 
- Ironbow 
- Grayscale 

See Selecting the Color Palette on page 42 for more information. The default position is Rainbow.

## ***Measurement Mode Switch***

The **Measurement** mode switch permits the user to change the way thermal information is presented on the display. Depending on the mode you choose, you will have all temperature points shown on the thermal image, or you may have just a narrow interval of temperature points being displayed at a time. The decision of which mode to use depends on each operator's needs and limitations.



There are three measurement mode positions associated with this switch:



**Automatic**



**Semi Automatic**



**Manual**

In **Automatic** mode the ThermoView imager automatically adjusts the image to show the lowest temperature value present in the thermal scene (MIN) and the highest temperature value in the scene (MAX).



In **Semi-Automatic** mode the ThermoView imager keeps calculating the MIN limit (lowest temperature value on the thermal scene) automatically.



In **Manual** mode the user can adjust **Gain** and **Level** manually.

See Selecting the Measurement Mode on page 42 for more information. The default position is automatic mode.

### ***Gain and Level Thumbwheels***

The **Level Thumbwheel** control adjusts the median point of a given temperature scale.

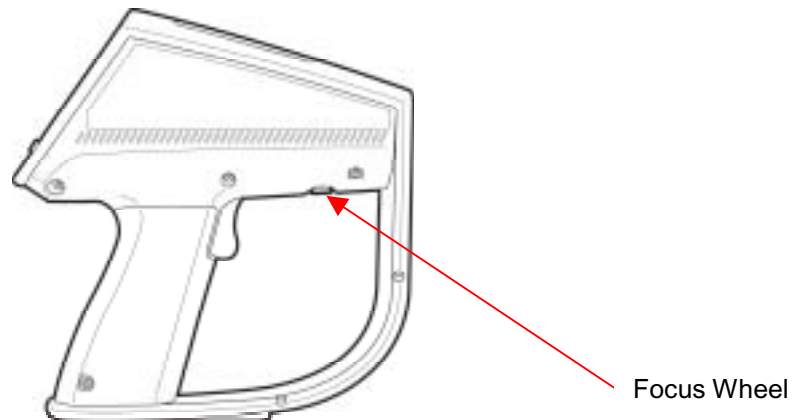
The **Gain Thumbwheel** control adjusts the temperature band around the median **Level** point.

See Gain and Level Thumbwheels on page 45 for more information about these controls.

### ***Focus Wheel***

The **Focus Wheel** is located on the bottom of the imager's housing in front of the trigger as shown in Figure 14. Adjust the focus by turning the Focus Wheel with your fingers or thumb.



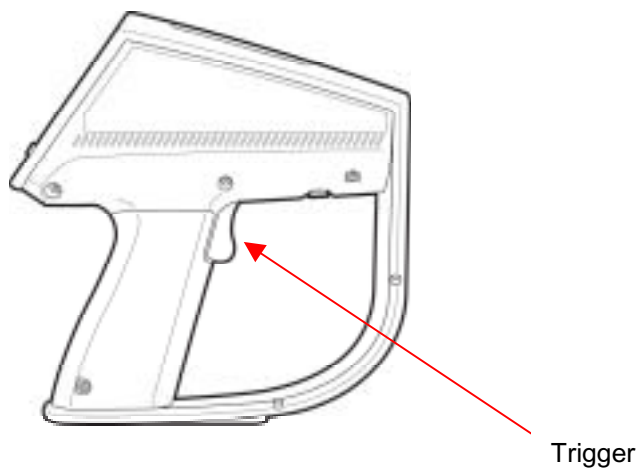


**Figure 14. Location of the Focus Wheel**

See The Importance of Focusing on page 41 for more details.

### ***Trigger***

Actuating the trigger freezes an image prior to storage. While in a regular measurement mode, pull the trigger momentarily, release it, and the thermal image on the display will be frozen so you can evaluate it for storage. If you don't want to store it, simply pull the trigger again and the unit will go back to measurement mode.

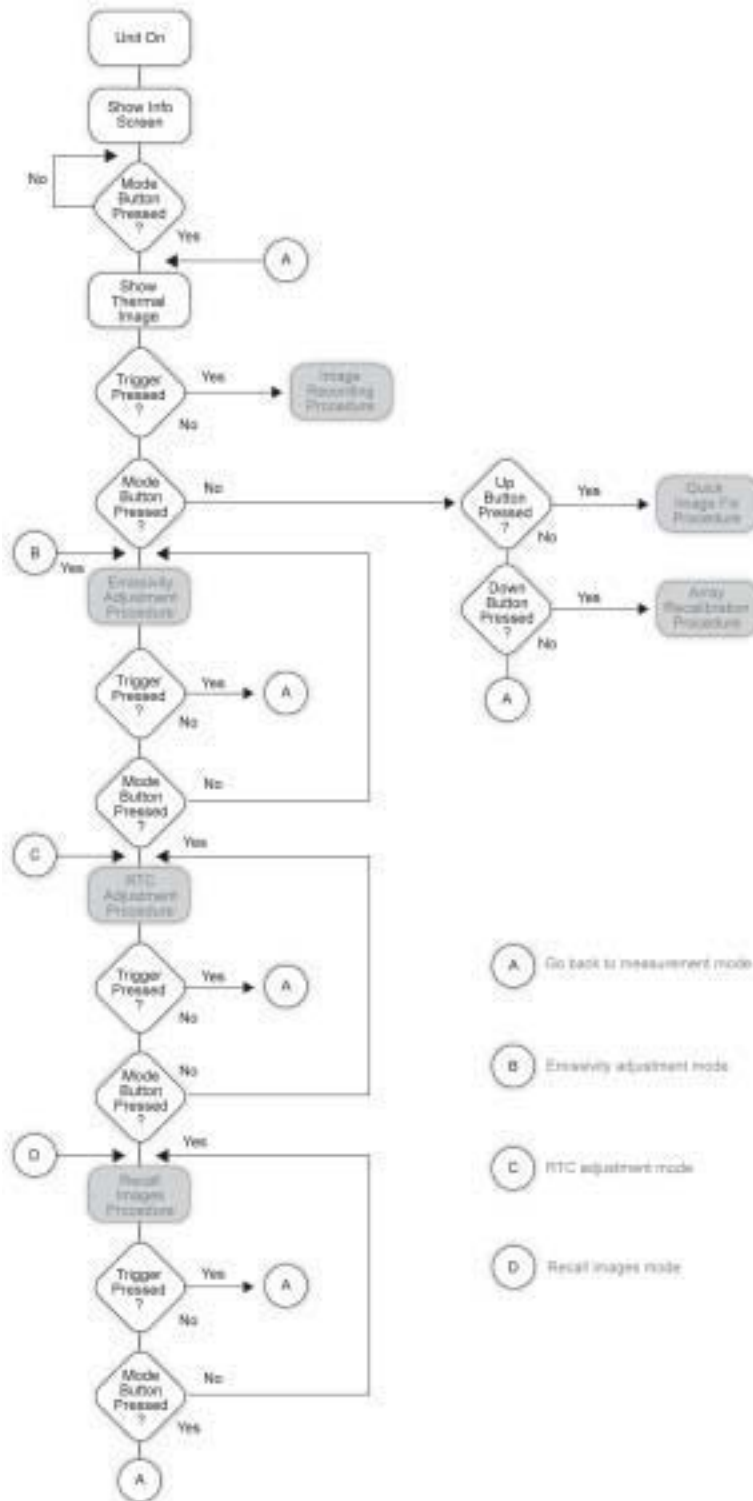


**Figure 15. Location of the Trigger**

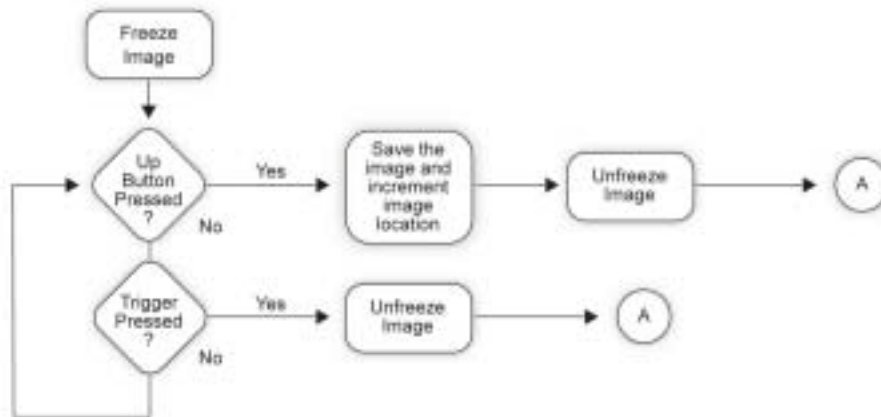


# Man Machine Interface Flow Charts

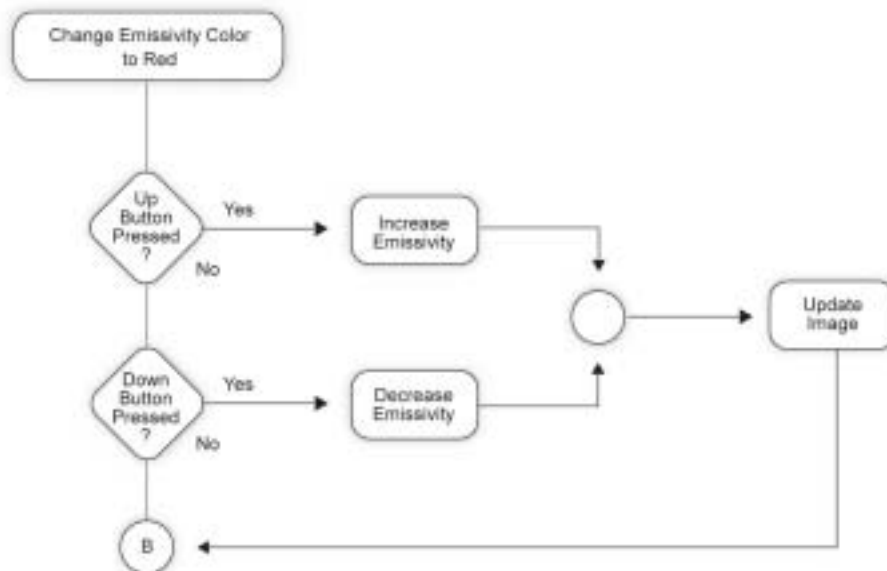
## Main Loop



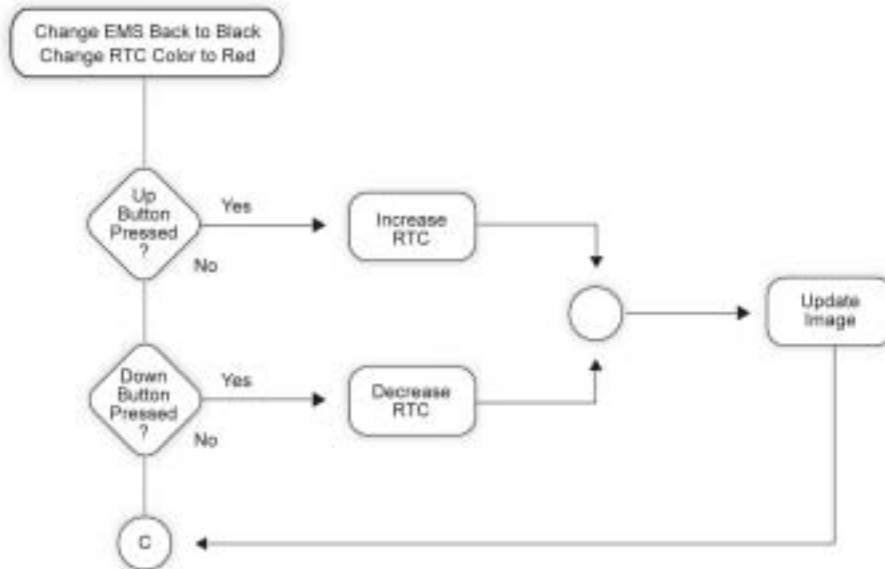
## Image Recording Procedure



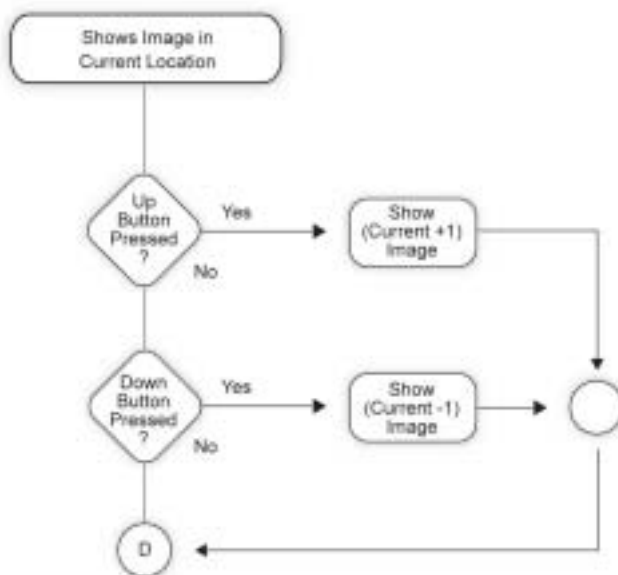
## Emissivity Adjustment Procedure



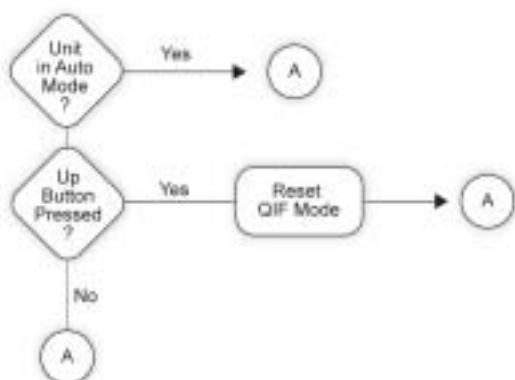
## Reflected Temperature Compensation Adjustment Procedure



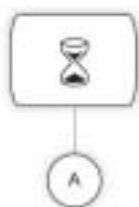
## Recall Images Procedure



## Quick Image Fix Procedure



## Array Recalibration Procedure



## Recording an Image

Recording images with the ThermoView imager is simple. Repeat the steps below and record as many images you want until you get familiar with the process.

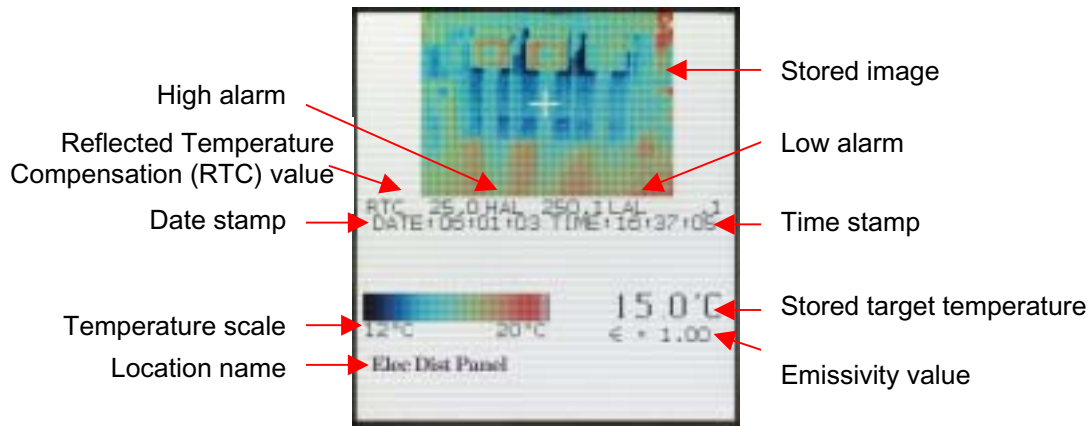
- First, note the number of the current image location. At this point, if you have not stored any images, the location number should be set at 1 (default) and the location descriptor will be blank. Similar to a camera, each image is numbered, so you may refer to images as one, two, three, etc. up to 100 images.
- Point the ThermoView imager at the target you want to record. Make sure the crosshatch at the center of the image pinpoints the spot of interest. Pull the trigger once and release it. This freezes the displayed image.
- Carefully inspect the image: If the result is satisfactory, press the **Up** button and the image will be stored at the current location, and the location counter will increment to next position automatically.
- If the image is not satisfactory: Press and release the trigger to discard the frozen image.
- Repeat the procedures described above to record more images.



**Note:** To erase an image, just store a new image over the one you wish to delete. To do this, go to Recall Images Procedure, press **Down** button once to decrement the location, press **Mode** button or trigger to get back to measurement mode, and pull trigger again to save a new image.

## Retrieving an Image

On **Measurement** mode, press the **MODE** button 3 times, browsing through **Emissivity Adjustment** and **Reflected Temperature Adjustment** modes (these adjustments are explained in Chapter 3 ). The thermal image and related data of the current location is shown on the display. Use the **Up** and **Down** buttons to scroll through the images you have previously recorded. All stored images can be downloaded to your computer later. To go back to measurement mode just pull the trigger or press the **MODE** button once more.



**Figure 16. Retrieve Mode**

The next chapter, Downloading and Looking at Images, leads you through installing the InsideIR software. You may then start downloading your images to your computer.

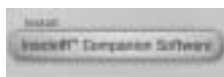
## Chapter 3 Downloading and Looking at Images

This chapter begins with the InsideIR software installation. Prior to installing the software however, please take a moment to verify that your computer meets the minimum requirements shown below:

- Microsoft® Windows® 98, Windows 2000 or Windows XP operating system
- Personal computer with a Pentium® III processor (450 MHz or higher recommended)
- 256 megabytes (MB) of RAM
- 500 MB of free hard disk space
- SuperVGA monitor with the screen resolution set to at least 800 x 600, recommended 1024 x 768 or greater; small fonts setting; and true color (32 bits)
- CD ROM drive
- USB rev. 1.1 port
- Printer, optional for printing reports

### *Installing the Software*

If you have exited your Interactive User's Manual, relaunch it by putting the User's Manual CD back in your CD-ROM drive. Once the application launches and you've selected your language, click the **Install InsideIR™ Companion Software** button.



The installation wizard will lead you through the installation process.

**Note:** Please take a few minutes to complete your product registration. You can register quickly online at [http://www.raytek.com/register/ti30\\_sw](http://www.raytek.com/register/ti30_sw) (preferred) or you can print the form and fax it to the number provided on the form.

Product registration is very important since it allows you to get free software updates from Raytek and helps us provide you with the fastest and most efficient technical support.

An icon for the InsideIR application is created and added to your folder during software installation. Do not launch the program yet. Wait until you have completed the next section, Connecting the Docking Station to Your Computer.



## **Connecting the Docking Station to Your Computer**


The docking station provides a solid and convenient base for the ThermoView imager. The docking station keeps the ThermoView imager available and connected to the computer or workstation. In addition, it keeps the batteries charged and ready to go. The docking station connects to your computer through its USB port. The USB cord should remain connected to the computer at all times.

### **Hooking Up the Docking Station**

- Connect the power adapter plug into the Docking Station's power jack.
- Connect the power plug to a power outlet. (Depending on the power requirements in your country you may need to use one of the several adapters provided that matches the power plug to the local power outlet.)



**Figure 17. The Docking Station**

- Find the USB port on your computer. Look for this symbol  on your computer.
- Locate the USB communication cord permanently attached to the docking station. (The USB communication cord is equipped with an USB connector.)
- Insert the USB connector on the cord to the USB port on your computer (see Figure 18).



**Figure 18. Connecting the USB Connector to the USB Port**

- Dock the imager in the docking station.
- The first time you place the imager in its docking station and press the **SYNC** button with the docking station connected, your computer's operating system will detect new hardware and locate the correct communication driver. Your computer will automatically launch its own driver installation program. Follow the installation instructions. You will only have to go through this process once.

You are now ready to launch the InsideIR application. Go to your computer desktop and double-click on the **InsideIR** program icon to launch it.



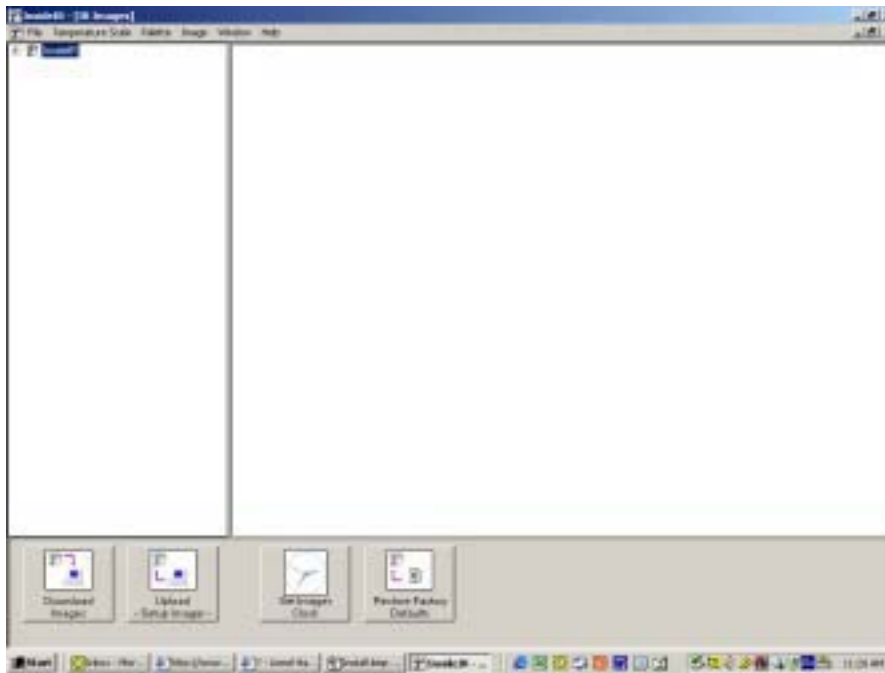
The following screen will appear:



**Figure 19. InsideIR Splash Screen**

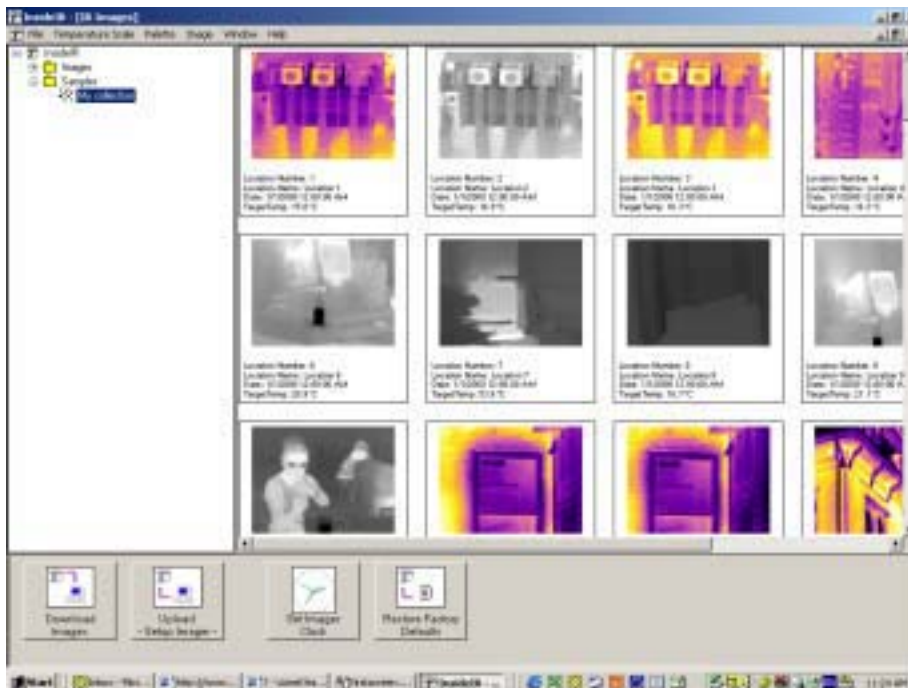
The screen appears momentarily and then the following screen appears:





**Figure 20. InsideIR Main Screen at Program Launch**

If you wish to view the sample images now, click the plus sign to the right of the Samples folder to open it. Then double-click on the session name (**My collection**, in our example below).



**Figure 21. InsideIR Main Screen With Session Open**

## Downloading Images

You are now ready to download the images you recorded in your ThermoView Ti30 imager. Locate the **SYNC** button in the docking station. Press the **SYNC** button once to begin the download process.



**Figure 22. The SYNC button**

When synchronization completes, the following window appears:



Once all data are downloaded, the information is saved into a temporary area where you may inspect the data before saving it to the disk. The following dialog window appears (images and data are for example only):

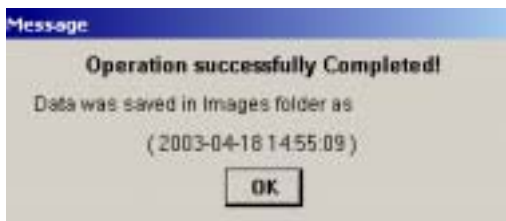


**Figure 23. Download Data Screen**

You can browse through the images by clicking and dragging the horizontal and vertical scroll bars.

You cannot delete individual images. You must decide whether to save the entire collection or not. Click **Save Data** to save it. By clicking **Cancel**, the data is not saved to the disk.

The following window appears when images are saved, signaling a successful operation:



Click on **OK**.

## ***Saving Images***

Following data storage, the application automatically opens the folder called “**Images**” showing the newly saved collection of images. The collection of images and their associated data is automatically saved, using the computer’s date / time settings. You can change the file names by right-clicking on the current name, although it is strongly recommended you keep the date / time information so you can keep track of your periodic inspections.

The screen below shows sample contents of the Images folder, with the newly saved file highlighted:

July 1, 2003

- 35 -

Version 1.0





**Figure 24. Contents of Images Folder**

Your newly recorded images appear as thumbnails as they are downloaded into the program.

Each set of images is in a fixed order so that you cannot rearrange the images. Use the scroll bars to browse through the thumbnail images.

## ***Setting the Imager Clock***

It is very important to set the **Imager Clock** in your ThermoView Ti30 imager because it records a time / date stamp with each stored image. This is important for meaningful reports and trending.



The imager's internal clock can only be set or changed from the computer. You cannot set or adjust it on the imager. It is very important to have the internal clock set to your local time / date, since your inspections will be tracked based on time / date information.

To set the time:

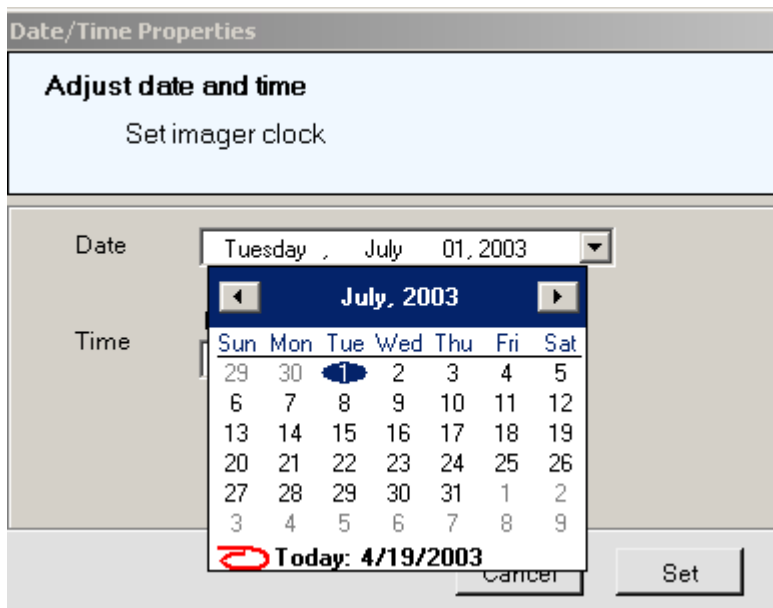
1. Press the **Set Imager Clock** button on the lower portion of the Main menu.

The following window appears:



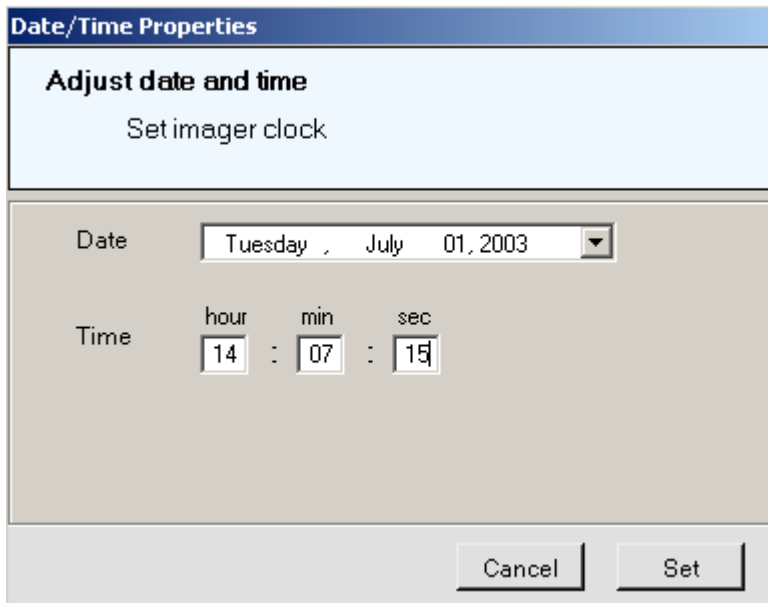
2. Click the **Date** arrow to see the calendar.

The following window appears:



- Click on the side arrow buttons to change the current year / month
- Click to select the day of the month.

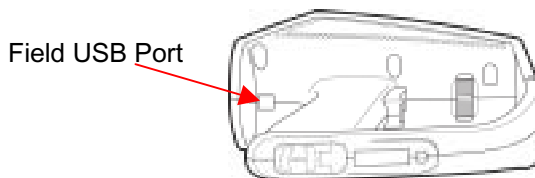
The following windows appears:



- To set the current time, click on the **hour** and **min** (minute) boxes to enter time information. Use the 24-hour time format only.
- Press the **Set** button to upload the information to the imager.

## ***Field USB Port***

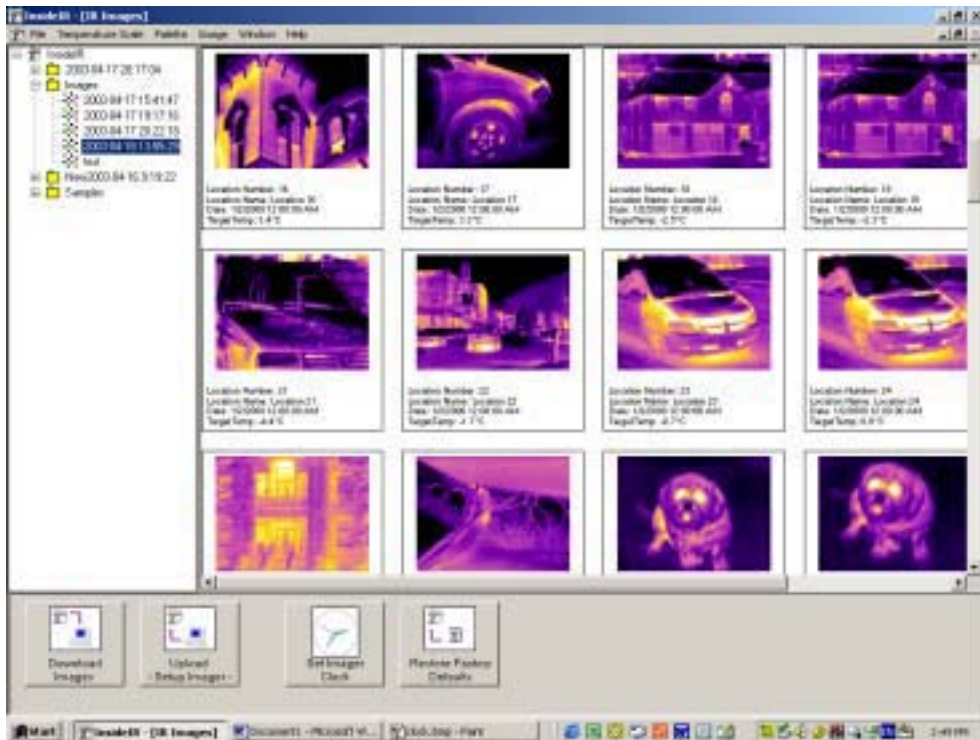
In the event you need to download your images to a computer without the docking station, you may use the USB cable included with your ThermoView Ti30. Connect the cable to the Field USB port, under the display. (See Figure 25) Once the cable is connected, follow all steps previously described.



**Figure 25. Field USB Port**

## ***Looking at Your Downloaded Images***

Images are automatically organized into directories as they are downloaded into the software program. All images from your latest download appear in a window that looks like the screen below. You can look at all image thumbnails by clicking on the two scroll bars.



**Figure 26. Viewing Thumbnail Images**

You can view a larger version of a single image by clicking on the thumbnail of the image you wish to view. When viewing a single image, you may move to the next or the previous image by clicking on the **Previous Image** or **Next Image** button on the left side of the screen (see Figure 27 below).

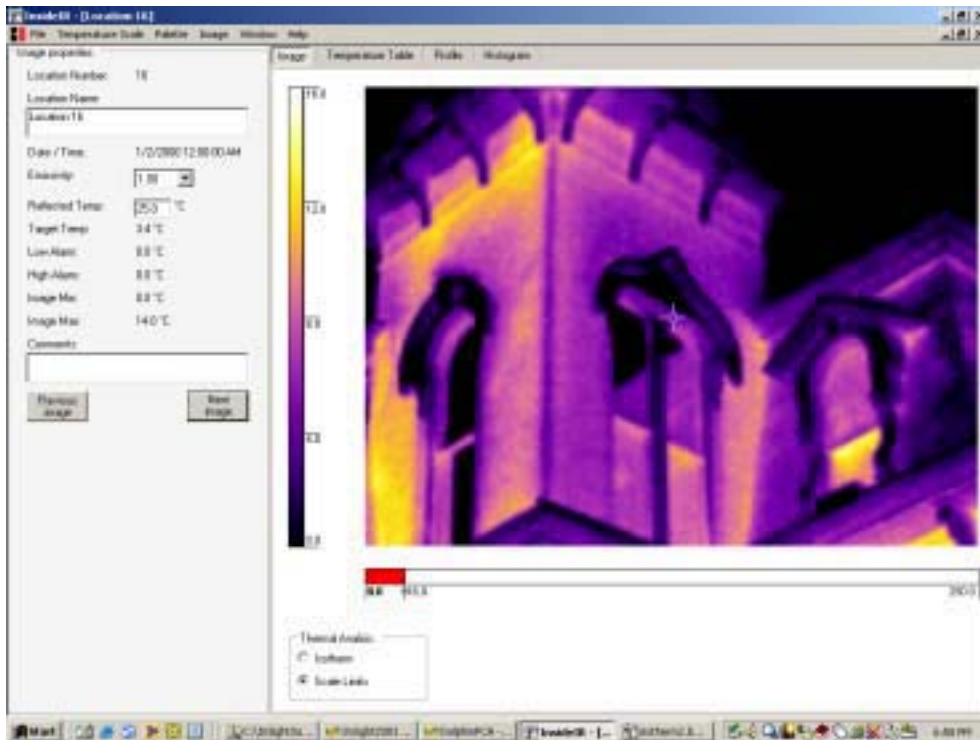


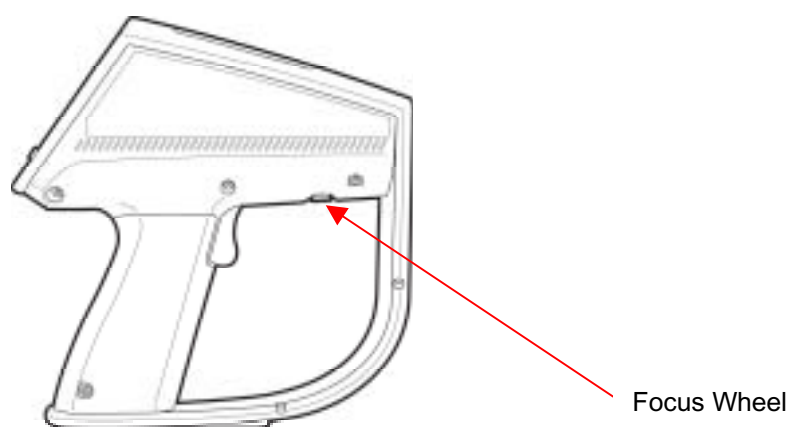
Figure 27. Viewing a Single Image



## Chapter 4 Obtaining the Best Image

### *The Importance of Focusing*

The focusing ability of the imager is similar to the one found on regular photographic cameras, and it is defined as the ability to adjust the optical system to capture the highest amount of infrared energy from the target, thus allowing the sharpest thermal image of the target to be displayed. Properly focusing the unit is of paramount importance for obtaining a crisp clear image. There is no way to compensate for an improperly focused thermal image afterwards.



**Figure 28. Locating the Focus Wheel**

Focusing is accomplished by rotating the **Focus Wheel** in either direction. The minimum focusing distance is 61cm (24 inches). That means you have to be at least 61cm (24 inches) away from your target to get it focused.

Rotating the **Focus Wheel** to the leftmost position (as viewed from operator's perspective) will focus the optics to the minimum focus distance of 61cm (24 inches) away from the unit. Rotating the **Focus Wheel** to the right, the optical system will gradually focus to longer distances. Rotating the **Focus Wheel** to the furthest right position will focus the optics at infinity.

To make sure your target is in focus, try starting with the **Focus Wheel** in the leftmost position, rotate slowly to the right, and stop when the image is at its sharpest. You may need to go back and forth until reaching the best focus adjustment. Alternately, you may move in and out while viewing a subject to determine where focus is best.

**Tip:** When focusing an image, look for identifiable patterns or shapes on the object surface that can help establishing the best image definition. Objects contours, dividing lines or limits are particularly useful. Proper focusing is not only important to the image quality, but also greatly affects the accuracy of temperature measurements. One way to verify if the unit is properly focused is to find what focus adjustment produces the highest temperature indication on the display (keep E and RTC values constant, preferably E set at 1.0 and RTC disabled).

## **Selecting the Color Palette**

The selected color scheme is mostly a matter of personal preference. In some cases, it makes sense to use a specific palette for specific applications. The rainbow palette provides more contrast between areas with close temperature values; on the other hand the ironbow palette may provide more visual comfort in some cases because the colors blend in smoothly. However, despite the popularity of color palettes, the gray scale is recommended for most measurements because it is easier for the human eye to discern subtle thermal changes on gray tones than colors.

**Tip:** Always begin with the gray scale palette while you get a feel for the thermal scene you are viewing. Then, work with the available measurement modes and the Level and Gain adjustments before choosing which color palette to use.

## **Selecting the Measurement Mode**

Measurement modes are simply different ways to present thermal information on the display. Depending on the mode you choose, you may display all temperature points shown on the thermal image, or you may select a narrow interval of temperature points being displayed at one time. The decision of which mode to use depends on your needs and limitations. From a thermal resolution standpoint, you are better off working with a narrow interval of temperature points, because you will be able to see very subtle temperature differences, since you have more colors or gray tones to represent fewer temperature points; on the other hand, if you are just looking for larger temperature differences, you can not work with a narrow temperature interval because important temperature values might not be displayed.

There are three measurement mode positions associated with this switch:



**Automatic**



**Semi Automatic**



**Manual**

In **Automatic** mode the ThermoView Ti30 imager automatically adjusts the image to show the lowest temperature value present in the thermal scene (MIN) and the highest



temperature value in the scene (MAX). The MIN and MAX values are displayed at the beginning and at the end of color scale. This mode does not require any other adjustment (other than properly focusing the unit). **Automatic** mode is recommended every time the user first starts looking at a given target since the temperature limits are unknown. This mode is also recommended when the user is looking for fairly large temperature differences (such as, looking for hot spots in electrical devices).

**Note:** The **Quick Image Fix** feature is a sub set of the **Automatic** mode. This is a convenient feature that fixes the MIN and MAX temperature values and thus creates a more stable thermal image for the user to view. To quick fix the image, simply press the **Up** button on the keypad once, and the temperature limits will stop adjusting automatically. Fixing the temperature limits provides a more comfortable experience for thermal image evaluation. The thermal boundaries (highest and lowest temperature values) will adjust automatically again when you record another image (see Recording an Image on page 28 for more information) or by pressing the **Up** button again while in the **Automatic** measurement mode. The **Quick Image Fix** feature is active only when the unit is set to **Automatic** mode.

Different from **Automatic** mode, **Manual** and **Semi Automatic** modes work jointly with two adjustable parameters: **Level** and **Gain**. These two parameters are adjustable by using the two thumbwheels located on the switch bay (see Figure 11 on page 20).



**Level** is defined as the median point of a given temperature scale. For example, if the unit is currently in **Automatic** mode, and there is a given thermal scene with MIN and MAX temperature limits, the moment you switch the unit to **Manual** mode, the Level value is set by the unit according to the following formula:

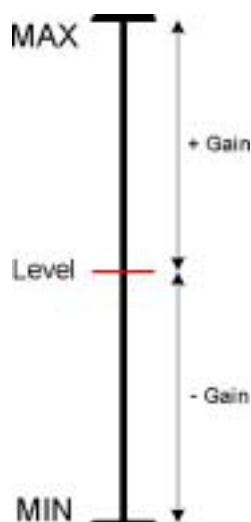
$$\text{Level} = \frac{\text{Max} + \text{Min}}{2}$$

**Gain** is defined as a temperature band around the median point of the scale (Level). In the same way described above, if the unit is currently set at **Automatic** mode, and there is a given thermal scene with MIN and MAX temperature limits, then switching the unit to **Manual** or **Semi Automatic** mode causes the Gain value to be set according to the following formula:

$$\text{Gain} = \frac{\text{Max} - \text{Min}}{2}$$



Graphically, it would look like this:



The imager automatically calculates **Level** and **Gain** when switched from **Automatic** to **Manual** or **Semi Automatic** modes, thus providing a smooth and meaningful transition of the thermal boundaries of the scene.

Once initially set by the ThermoView imager, **Gain** and **Level** can then be adjusted by the user in order to accommodate their specific requirements.

Of course, in practical terms you can't actually see the values for **Gain** and **Level**. You will adjust **Gain** and **Level**, but you will see the changes on the MIN and MAX temperature values at each end of the thermal scale. Since we know how **Level** and **Gain** are calculated by the imager, it is easy to understand how variations in **Gain** and **Level** change the MIN and MAX limit values by solving the **Gain** and **Level** equations for MIN and MAX as follows:

$$\text{Min} = \text{Level} - \text{Gain}$$

$$\text{Max} = \text{Level} + \text{Gain}$$

In summary: you need to adjust **Level** to get close to temperature level you are interested in and then adjust **Gain** to get you more or less resolution as needed around the desired level.

**Tip:** Always begin by selecting the **Automatic** mode. **Automatic** mode will suffice for most applications. The unit automatically adjusts the image to show the lowest temperature value present in the thermal scene (MIN) and the highest temperature value in the scene (MAX), at all times. This mode does not require any other adjustment (other than properly focusing the unit). Once you are familiar with the thermal scene you are looking at just press the **Up** button to activate the **Quick Image Fix** feature, described on the previous pages. When you press the **Up** button the imager fixes the MIN and MAX temperature values, thus allowing a more stable thermal image for the viewer. The next step is to capture the image for downloading later. To freeze the image, simply pull the trigger once and then press the **Up** button to actually save the image.



In **Semi-Automatic** mode the ThermoView imager keeps calculating the **Level** automatically. This mode is recommended when the user is interested in controlling the resolution around a varying temperature level, thus saving the user a lot of trouble and time trying to constantly adjust **Level**.





In **Manual** mode the user can adjust **Gain** and **Level** manually. Use this measurement mode when you need more freedom to define **Level** and **Gain** values. This mode provides the flexibility to bring both MIN and MAX values to the desired cut-off levels and to adjust the temperature interval to a minimum, thus maximizing color resolution. Using the Manual mode efficiently requires more experience with both thermal imaging techniques and specific knowledge of the equipment being inspected. However, Manual mode provides the best possible image definition as to the specific inspection situation at hand, both from a thermal resolution and temperature level standpoint.

**Tip:** The minimum temperature interval between the MIN and MAX values is 5° C / 9° F. It is important to remember that by decreasing the difference between MIN and MAX values increases the likelihood of *image noise*. Only bring the difference between MIN and MAX to the minimum when you absolutely need the best thermal resolution available.

### **Gain and Level Thumbwheels**

The **Level Thumbwheel** control increases **Level** by pulling the wheel towards the back of the imager and decrease **Level** by pushing the wheel forward towards the front of the imager. When **Level** is increased both MIN and MAX values increase accordingly and when **Level** is decreased both MIN and MAX values are decreased accordingly.

The **Gain Thumbwheel** control increases **Gain** by pulling the wheel towards the back of the imager and decreases **Gain** by pushing the wheel toward the front of the imager. When **Gain** is increased, MIN value decreases and MAX value increases accordingly. When **Gain** is decreased, MIN value increases and MAX value decreases accordingly. **Gain** can be decreased up to the point when the difference between MIN and MAX values is 5° C / 9° F.

**Note:** Both wheels have endless adjustment action (no détente).



# Chapter 5 Qualitative and Quantitative Temperature Measurements

Most of the time thermal imager users are measuring *apparent temperatures* that are inextricably linked to *qualitative inspections*. Qualitative inspections focus on *temperature differences* as opposed to *actual temperatures*. The reason is that temperature differences are sufficient to indicate most abnormalities in electrical and mechanical equipments. In other words, qualitative inspections don't aim at taking accurate temperature measurements. Their goal is to capture and identify different thermal patterns in a given thermal scene, which are indicative of potential failures and / or equipment malfunctioning. Since there is no intention to measure the *actual* or *absolute value*, the technician has no need to correct for target emissivity (which is set at "1" on qualitative inspections), reflected temperature from the environment (which is not enabled in the unit on qualitative inspections) or account for target spot size and distance from the target (quite often the target of interest is always compared to a similar target in the same thermal scene). Also, the operator does not need to adjust or account for atmospheric attenuation, angle of incidence and other interfering factors.

On the other hand, quantitative inspections are intended to accurately measure the actual temperatures of specific areas in electrical or mechanical equipment. Although less common than qualitative inspections, quantitative inspections are sometimes required. One good example would be measuring electric motor temperatures: in this case, the absolute temperature value is required since it is closely linked to the useful life of the motor. To accurately measure temperature using infrared temperature measurement technology, the customer should be aware of the key concepts and factors that can radically interfere with the quality of the quantitative temperature measurement.

The following reviews each of these factors.

## ***Distance to Target (Spot) Ratio***

The optical system of an infrared sensor collects the infrared energy from a circular measurement spot and focuses it on the detector. Optical resolution is defined by the ratio of the distance from the instrument to the object, compared to the size of the spot being measured (D:S ratio). The larger the ratio factor the better the instrument's resolution, and the smaller the spot size that can be measured from a greater distance.

All non-contact infrared thermometers and thermal imagers have a specific optical resolution, expressed by the D:S ratio and by the optical diagram, which shows the geometry of the infrared radiation path as seen by the lenses of the instrument.

See Figure 29 for an illustration of the D:S ratio and the optical chart for the ThermoView Ti30 unit.

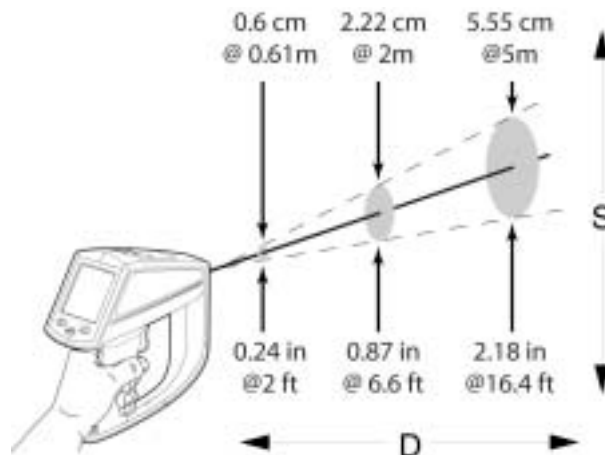


## ***D:S ratio: $D / S = 90$***

The number “90” means that at a distance  $D$  equal to 1 meter the unit will measure a circle of diameter  $S$  equal to 1.1cm (1meter divided by 90); at distance  $D$  equal to 2 meters it will measure a circle with diameter  $S$  equal to 2.2cm and so on in a linear progression.

## ***Optical Diagram***

The optical diagram shows the graphical representation of the optical ratio. The optical path of the infrared radiation is a cone that has its vertex at 61cm (24”) away from the front of the unit, and progresses at the same ratio towards infinity. The circle diameter can be calculated by dividing the distance by 90 at any point in the centerline of the cone. Below it is presented the diameters  $S$  for three different distances: 61cm (minimum distance), 2m and 5m. There is no maximum distance. Although, in practical terms, accurately measuring temperatures of targets further than 5m requires fairly big objects.

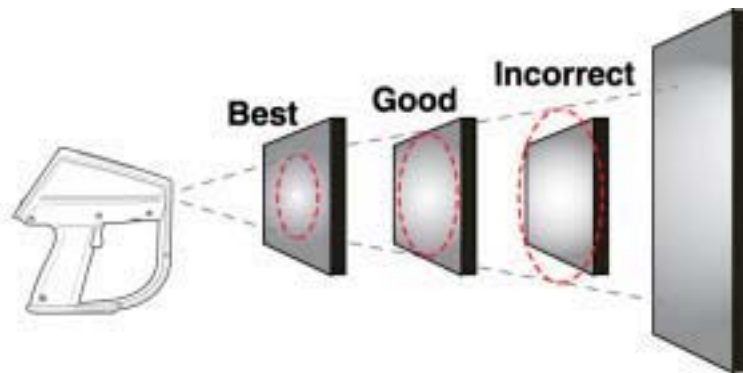


**Figure 29. Illustration of Distance to Target / Spot Ratio**

The explanation of optical resolution is key for the understanding of the next concept, vital for accurate temperature measurement in quantitative inspections.

## ***Field-of-View***

Make sure that the target is larger than the spot size that the unit is measuring. The smaller the target, the closer you should be to it.



**Figure 30. Field of View**

**Tip:** When accuracy is critical make sure that the target is at least twice as large as the spot size.

## ***Environmental Conditions***

Watch for environmental conditions in the working area. Steam, dust, smoke, etc., can prevent accurate measurement by obstructing the path between the target and the unit's optics. Noise, electromagnetic fields, or vibration are other conditions that can interfere with temperature measurements, and should be considered before starting temperature measurements.

**Tip:** If interfering factors can not be mitigated try to change your position relative to the source of interference, or pick a time when interfering factors are not present or at a smaller level.

## ***Ambient Temperatures***

The imager's operating temperature range is 0 to 50° (32 to 122°F). Its calibration is maintained within this range. The unit will not perform in terms of the accuracy and repeatability if used outside the stated operating temperature range. Also, if the imager is exposed to abrupt ambient temperature differences of 10°C (18°F) or more, allow it to adjust to the new ambient temperature for at least 20 minutes.

**Tip:** When inspecting equipment in a plant, plan the sequence of locations to be inspected so the ambient temperature changes are gradual.



## ***Emissivity***

Emissivity is the measure of an object's ability to emit infrared energy. Emitted infrared energy is exponentially proportional to the temperature of the object. Emissivity can have a value from 0 (shiny mirror, perfect reflector) to 1.0 (blackbody, perfect emitter). Most organic, painted, or oxidized surfaces have emissivity values close to 0.95. If you are performing qualitative inspections with your imager, leave the emissivity set at 1.0. If you need to measure actual temperature values, set the emissivity value according to the emissivity of the material the object you are measuring is made of. Again, if you need accuracy, you will need to find the emissivity value of the material before taking the measurement. See Table 1 on page 68 and Table 2 on page 69 for the emissivity values for the most common materials.

There are a couple of methods that help you to find the emissivity value of materials:

- **Tape method:** this method requires the usage of the Scotch<sup>®</sup> brand PVC tape (emissivity value 0.97) or equivalent. Cover the surface you want to measure with tape. Wait some seconds for the temperature to stabilize. Set the emissivity of the imager at 0.97 and measure the temperature. Make a note of the temperature value. Then, remove the tape and measure the new temperature value. Adjust the emissivity accordingly until the temperature value found previously is displayed on the unit. This emissivity value is the one of the material being measured. This method is good for objects that are at low temperatures (under 100°C (212°F)), not electrically energized and not in motion.
- **Contact thermometer method:** this method will need a contact probe and good quality temperature meter. Initially, use the contact probe temperature meter to measure the temperature of the object you want to know the emissivity value, allowing time for the contact probe to stabilize (this may take up to a minute). Make a note of the temperature value. Adjust the emissivity on the imager accordingly until the temperature value found previously with contact probe temperature meter is displayed on the imager display. This emissivity value is the one of the material being measured. This method is good for objects that are at moderately high temperatures (under 250°C (482°F)), not electrically energized and not in motion.

To set or change the **Emissivity** value, complete the following:

1. Put the ThermoView Ti30 imager in regular **Measurement** mode.
2. Press the **MODE** button once. At this point you will be able to adjust **Emissivity**.
3. Set the **Emissivity** value to the proper value, according to the target material, by pressing the **Up** and **Down** buttons.

## ***Reflected Temperature Compensation***

Targets that have low emissivities will reflect energy from nearby objects. This additional reflected energy is added to target's own emitted energy and may result in inaccurate readings (see Figure 31 below). In some situations objects near the target (machines,

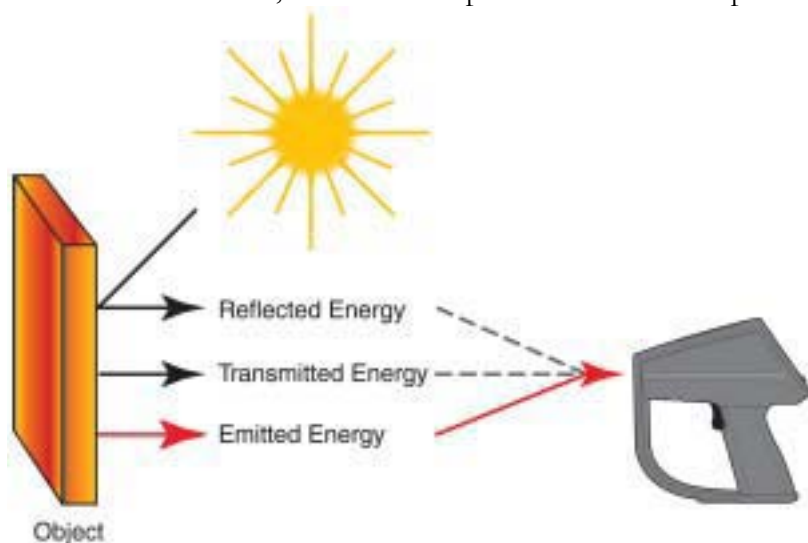


furnaces, or other heat sources) have a temperature much higher than that of the target. In these situations it is necessary to compensate for the reflected energy from those objects.

**Note:** The Reflected Temperature Compensation (RTC) feature is disabled if the emissivity is set to 1.00.

To set or change the **RTC** feature, complete the following steps:

1. You will need an infrared reflector. Take a piece of aluminum foil. Crumple and re-flatten the foil and put it on a cardboard plate, shiny side up.
2. Put the ThermoView Ti30 imager in regular **Measurement** mode.
3. Press the **MODE** button once. At this point you will be able to adjust **Emissivity**.
4. Set the **Emissivity** value to 1.00.
5. Position the imager at the selected measurement distance from the target to be measured. Aim and focus the unit on the target.
6. Now, place the infrared reflector in the field-of-view of imager. Position the reflector in front of and parallel to the target surface.
7. Measure the apparent surface temperature of the surface of the reflector. This temperature is the reflected temperature of the target. Make a note of this temperature value.
8. It is a good idea to repeat the steps from 5 to 7 and then average the results. Make a note of the average.
9. Press the **MODE** button one more time. At this point you will be able to adjust the **RTC** value.
10. Enter the value found on step 8 for **RTC**, by pressing the **Up** and **Down** buttons.
11. To enable the **RTC**, make sure the set the **Emissivity** properly, according to the object material. If set at 1.00, the **RTC** compensation won't take place.



**Figure 31. Reflected Temperature Compensation**

## Chapter 6 Organizing Your Data

The ThermoView imager when used together with the InsideIR software provides a powerful way to organize and track maintenance data. Different groups of equipment can be inspected and data specific to different plant areas or departments can be individually named, saved, stored and retrieved in a straightforward fashion. Because all the records are electronic, they can be backed up and stored without fear of loss or fading of records.

### **File Management**

You can rename or delete files (“sessions”) or folders from the directories by right-clicking the icons in the file structure on the left side of the screen and choosing the appropriate command from the pop-up menu. You may move a file by clicking it and dragging it onto the destination folder.

**Note:** Keep in mind that a file (or “session”), is a collection of images—not a single image.

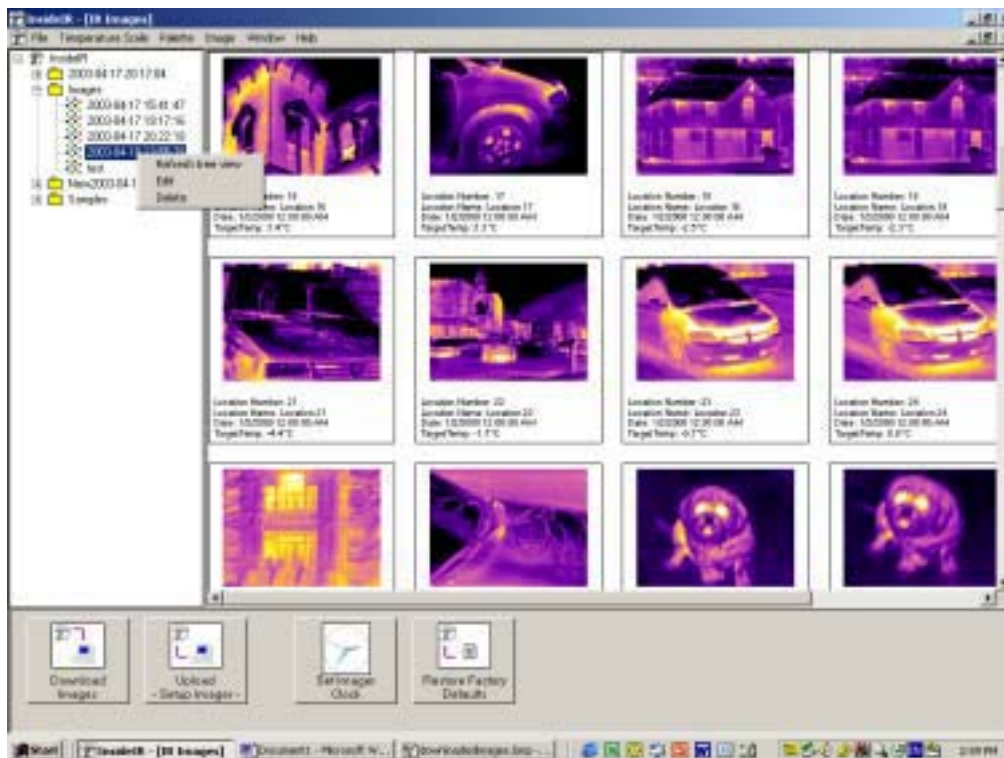
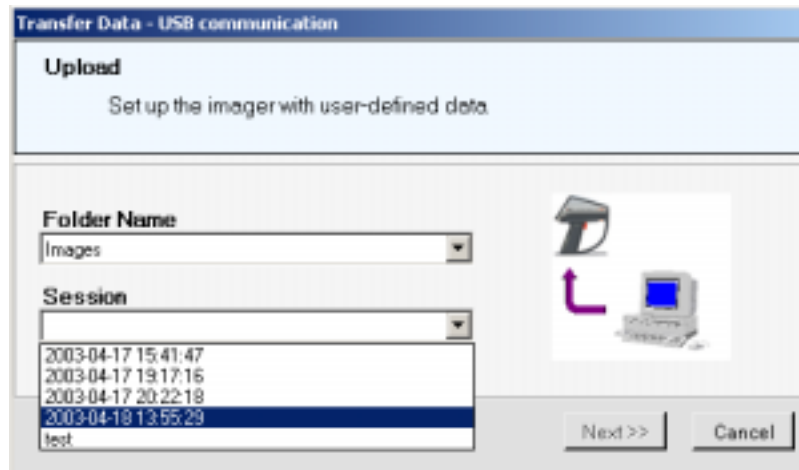


Figure 32. Organizing Your Files

## Uploading Data to the Imager



Click the **Upload Setup Imager** button on the InsideIR main screen to upload data to the ThermoView imager. This displays the following screen:



Select the folder and session you want to upload and press **Next**.

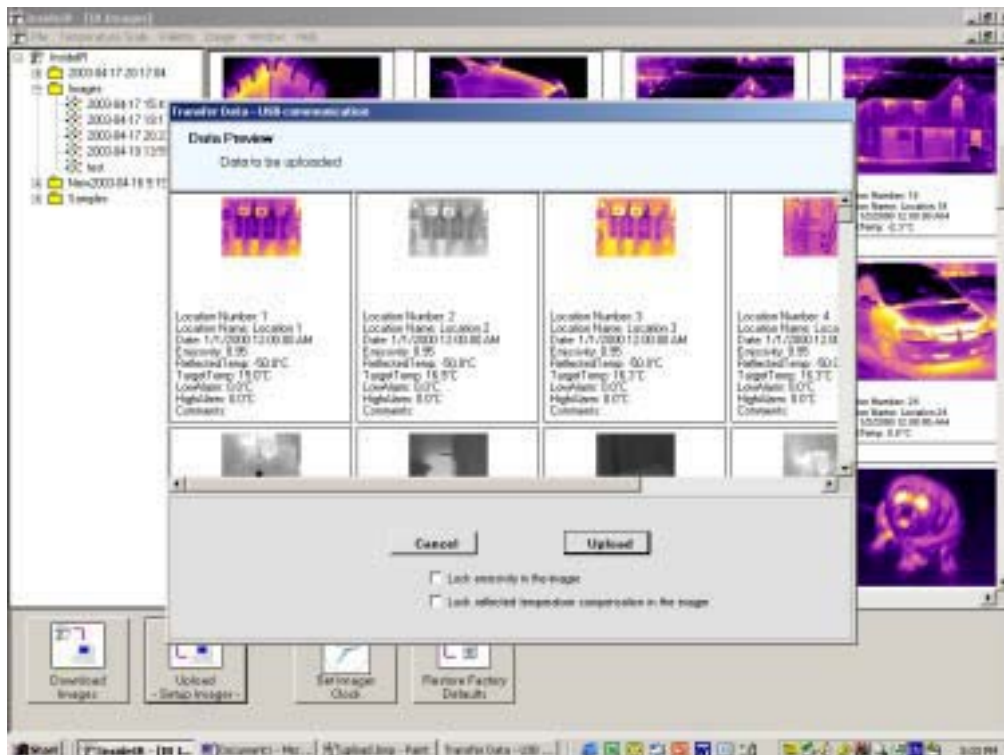
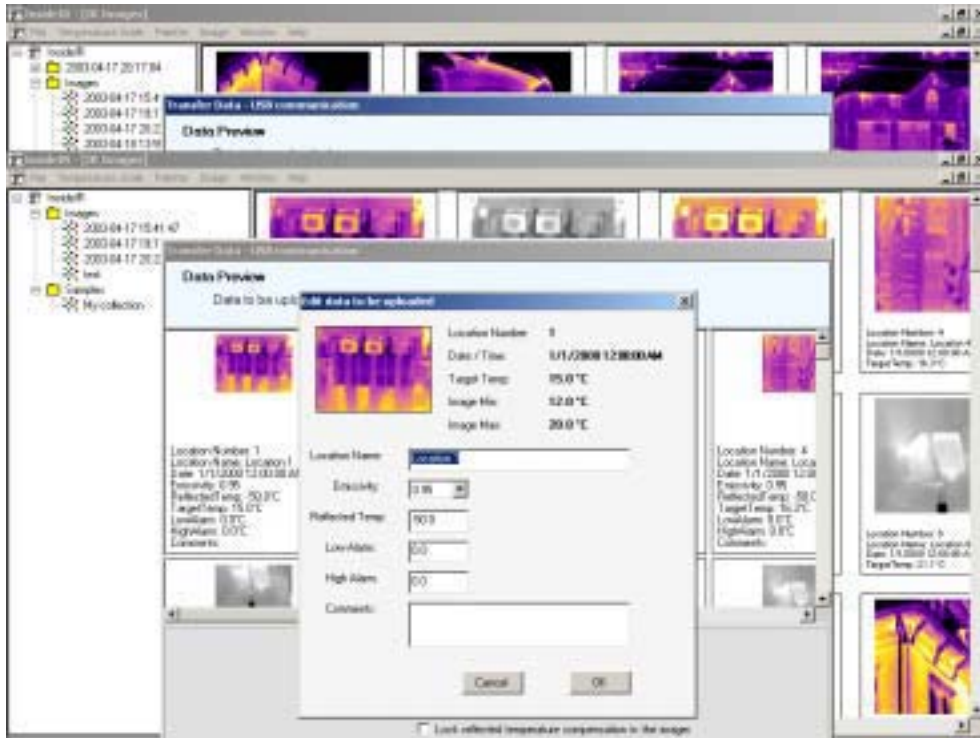


Figure 33. Uploading Data to Your ThermoView Ti30 Imager



If you wish to change parameters for different locations such as location name, emissivity, reflected temperature compensation, low and high alarms, and comments, you can do so by right-clicking the thumbnail of the image you wish to edit, clicking **Edit data** in the pop-up menu, and changing the desired field(s).



**Figure 34. Editing Data Before Upload**

- Note 1:** Checking the Lock Emissivity or Lock Reflected Temperature Compensation will prevent the operator of the imager from changing these values in the field.
- Note 2:** Because you cannot change the order of image locations it is important to plan the order of your database carefully.

To upload the data to the imager, press **Upload**. The imager will begin to load data.

Once the data is loaded, you are ready to perform your inspections. Upon your return, you simply place the imager in the docking station, and bring up the software. The new data is sent to the proper destination and is ready for comparison with any earlier data.

- Note 1:** It isn't necessary to upload data to the imager in order to perform inspections. However, it is recommended in order to keep consistency between inspections by using the same parameters for each location to be inspected.

**Note 2:** If you wish to restore the default parameters on the unit press the **Restore** button.



By doing this all 100 locations on the imager will be restored with the factory parameters. These default parameters are:

Location name: *blank*

Emissivity: 1.00

RTC: OFF

Low alarm: 0°C / 32° F

High alarm: 250°C / 482° F

Comments: *blank*



## Chapter 7 Analyzing Your Data

There are many ways to analyze your thermal data now that you have it downloaded and organized. After clicking on a thumbnail in the Main InsideIR screen, the data for that specific thermal image is displayed in one of four tabs: Image, Temperature Table, Profile, and Histogram.

While each of these analytical tools possess unique qualities, they also share many features. For example, data from any of the tabs may be saved in other formats or cut and pasted into other applications for your own further analysis or communications needs. The four tabs also share many commands on the menu bar, which will be explained at the end of this chapter.

InsideIR allows you to open many windows at one time. Keep in mind that functions on the menu bar are always associated with the active window.

### ***The Single Image Screen***

Clicking any of the thumbnail images in the Main InsideIR screen takes you to the **Image** tab for that image. On this screen, you can view basic data about the image.

Clicking on any part of the image will display the temperature reading at that spot (indicated by the crosshatch). You may click as many spots as you wish, with each click adding a reading to the displayed image. To erase the displayed temperature points, simply click while moving your mouse. Clicking and dragging around the image will momentarily display the temperature reading on points along your path.

### ***Scale Limits***

When the **Scale Limits** radio button at the bottom of the **Image** screen is selected, the limit bar underneath the image shows the temperature range your ThermoView Ti30 imager is capable of measuring. The minimum (0° C / 32° F) is represented at the far left of the bar, and the maximum (250° C / 482° F) is represented by the far right of the bar. The red area on the bar indicates the range of temperatures, within the minimum and maximum limits, that are represented in the thermal scene.

In order to see more detail in narrow ranges of temperature, it is often useful to adjust the scale limits. In order to do this, make sure the **Scale Limits** radio button is selected. To adjust the upper or lower limits, click and drag the appropriate arrow at the edge of the red portion of the bar. To keep the same range span but change the limits, you can drag the whole red section of the bar left (colder) or right (warmer).

To go back to the original scale, double-click on the scale bar.



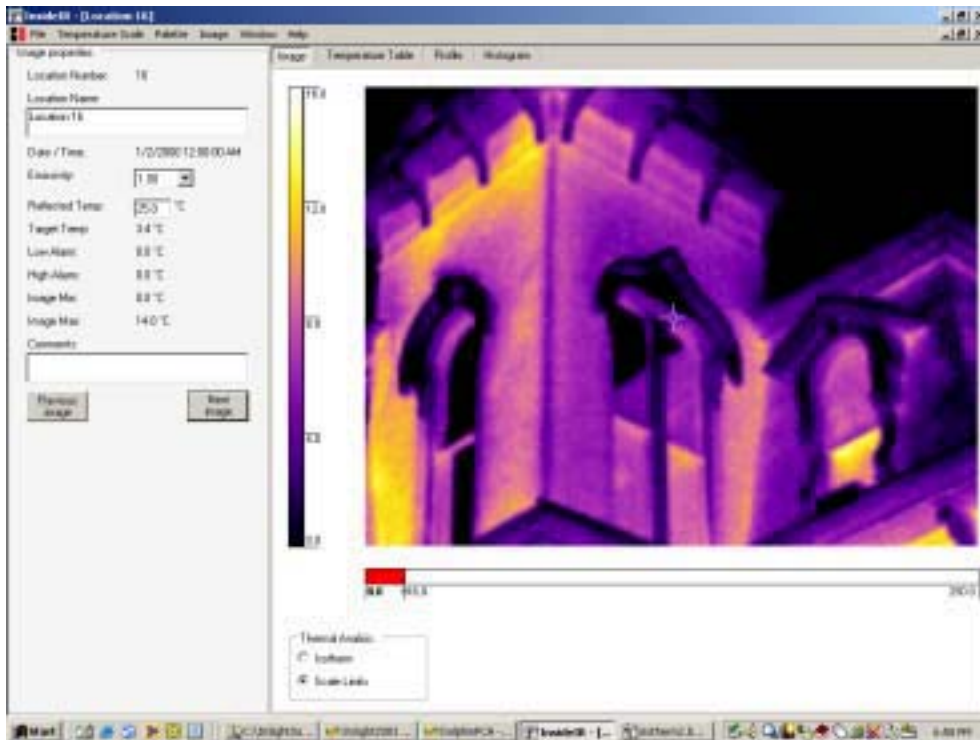


Figure 35. Sample Image at Original Scale Limits

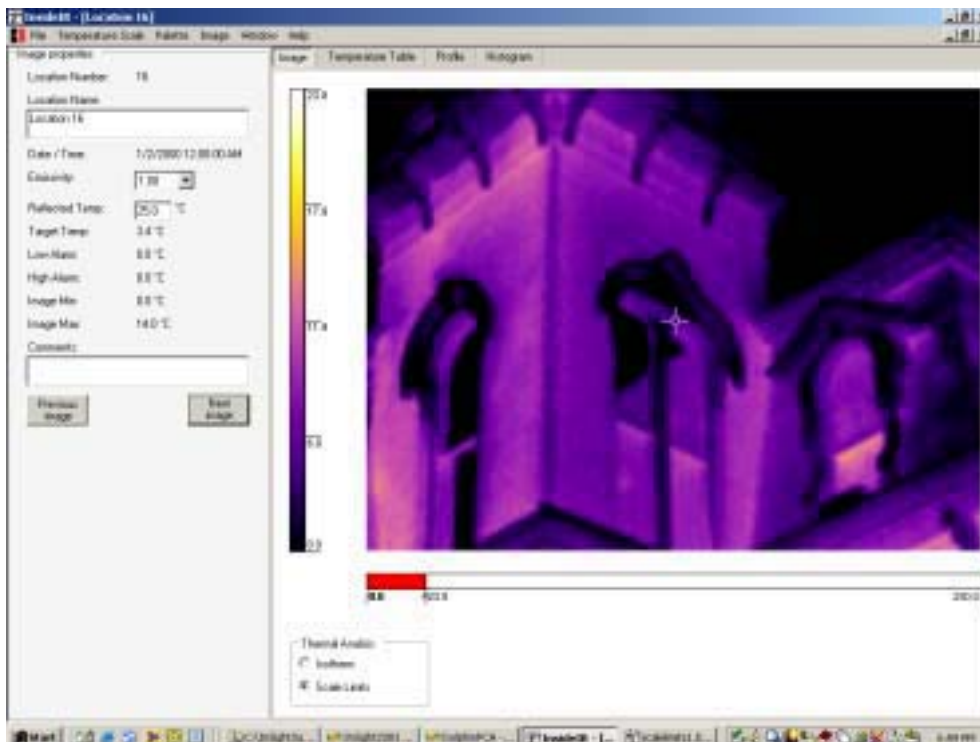


Figure 36. Sample Image After Increasing Scale Limits



## Isotherms

When the **Isotherm** radio button at the bottom of the **Image** screen is selected, the limit bar underneath the image shows the temperature range captured in the current thermal image. The red area on the limit bar indicates the range of temperatures displayed in red in the image. This range is also indicated on the temperature scale to the left of the image. To adjust the highlighted range, move the limit arrows on either edge of the limit bar, or the limit bar itself.

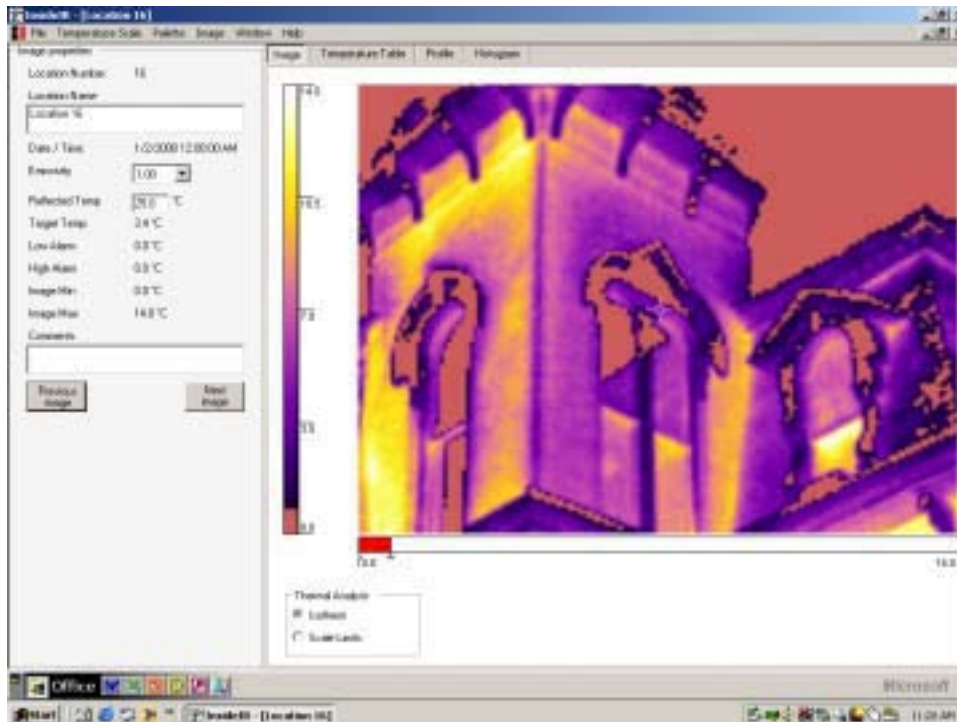
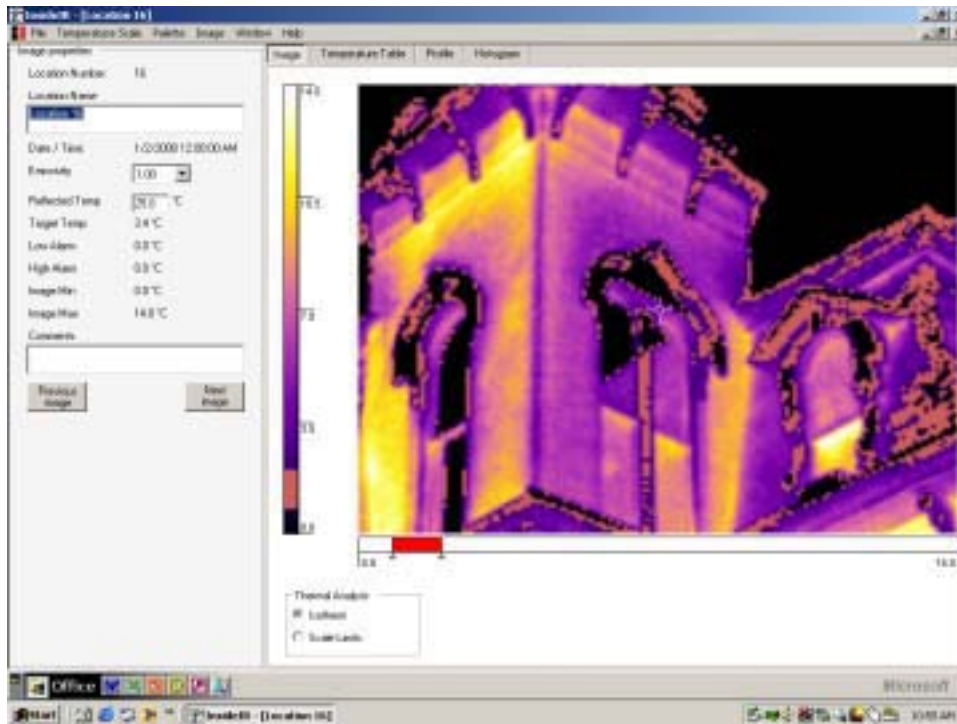


Figure 37. Sample Image at Original Isotherm Setting



**Figure 38. Sample Image After Adjusting Isotherm Level**

### ***Additional Image Analysis Tools***

You can tile the window vertically or horizontally by selecting the appropriate choice under the Window menu. The tiled windows may then be resized by grabbing any corner of the window and dragging accordingly.

Finally, you can further analyze the image under different **Emissivity** and **Reflected Temperature** conditions by changing those values on the left side of the screen. This does not affect the emissivity value of the original image.

Once you have reviewed the image data at this level, you can proceed to other views of the data.

### ***The Temperature Table Tab***

Clicking on the **Temperature Table** tab reveals a pixel view of all the data in the image. An example is shown below.

Col/Row	1	2	3	4	5	6	7	8	9	10	11	12	13	14
1	25.1	25.1	27.1	27.1	27.1	27.1	27.1	26.5	26.8	27.0	27.0	27.0	26.8	27
2	26.5	27.0	26.8	26.4	26.4	26.1	26.4	26.5	26.5	26.4	26.6	26.4	26.5	26.7
3	28.2	28.4	28.4	28.1	29.3	29.8	29.8	26.1	25.5	26.0	25.4	25.6	25.5	25.1
4	26.0	26.0	26.7	25.5	26.2	25.8	24.8	26.0	24.6	24.9	24.6	24.7	24.2	24.1
5	28.2	28.7	28.7	28.8	28.5	28.8	28.6	24.2	24.0	23.5	23.5	23.7	23	23
6	24.2	24.5	23.8	24.6	23.2	22.5	22.5	22.0	21.3	21.3	21.1	20.9	20.2	20.1
7	23.3	22.9	23.2	22.9	23.8	22.9	22.6	22.6	22.1	22.6	22.9	22.2	22.6	22
8	22.7	23.0	23.2	22.5	22.5	22.7	22.5	22.7	22.5	22.5	22.7	22.2	22.6	22
9	22.9	23.0	23.0	22.9	23.5	23.2	23.2	22.8	23.7	23.9	24.2	24.2	24.5	24.1
10	23.0	24.6	24.5	24.8	24.8	25.8	25.2	25.4	25.5	26.0	26.4	26.5	26.7	26.1
11	24.6	27.0	26.6	26.2	26.3	26.9	27.2	27.2	27.2	27.9	27.9	28.2	28.1	27.1
12	29.0	28.6	28.8	28.2	29.2	29.4	29.9	28.6	29.0	28.2	28.2	28.0	27.9	29.1
13	28.7	28.1	28.2	28.5	30.8	30.6	30.4	30.3	31.0	31.4	31.5	31.6	31.3	31.2
14	31.6	31.9	31.6	31.8	32.8	32.6	32.4	32.7	32.8	33.0	32.9	32.9	32.8	31.1
15	32.6	32.5	33.0	32.6	33.8	33.2	33.2	33.4	33.2	33.4	33.7	33.7	33.2	32
16	32.2	32.5	33.4	32.7	33.4	33.4	33.4	33.8	33.7	33.7	34.0	33.5	33.2	32
17	33.4	33.6	33.5	33.2	33.7	33.8	33.7	33.9	33.8	33.6	34.2	33.7	33.4	32
18	33.4	33.5	33.5	33.2	33.7	33.7	34.1	33.7	33.5	33.7	34.0	34.0	33.6	32
19	33.8	33.6	33.7	33.2	33.6	34.8	33.6	33.7	34.1	34.2	34.2	34.0	33.4	32
20	33.9	33.5	33.6	33.6	33.8	33.8	33.8	33.8	33.9	33.9	33.9	34.1	33.4	32
21	33.7	33.6	33.5	33.6	33.2	33.8	33.8	33.7	33.7	33.2	32.9	33.4	33.6	32
22	34.0	33.5	33.5	33.4	33.5	33.8	33.7	33.8	33.3	33.9	33.7	33.0	34.8	32
23	34.2	33.5	33.5	33.5	33.5	34.8	33.7	33.6	33.2	33.0	32.3	28.2	27.6	30
24	34.0	33.2	33.2	33.2	33.6	33.7	33.8	33.8	33.8	33.4	33.2	32.2	34.6	32
25	34.2	33.6	33.4	32.6	32.9	32.2	32.1	31.5	31.6	32.0	34.0	34.8	34.4	34
26	34.1	33.2	32.6	33.2	33.4	29.7	29.8	28.9	28.4	28.9	33.4	33.9	33.2	29
27	34.7	32.0	28.5	28.2	28.2	28.9	27.7	27.7	27.8	28.2	28.1	28.2	28.2	28
28	34.0	33.5	28.4	28.4	27.6	27.5	27.1	26.8	27.4	27.5	27.6	27.6	28.2	28
29	33.9	32.2	28.4	27.5	27.5	28.8	26.7	26.4	26.5	26.9	27.1	27.4	28.0	28
30	35.0	33.9	27.7	28.8	28.5	28.5	26.1	26.1	26.4	26.4	28.7	28.4	27.2	28
31	34.6	34.0	27.4	28.2	26.8	26.2	26.3	26.4	25.7	26.1	26.1	28.4	24.5	27
32	34.2	33.2	27.0	28.2	26.2	26.8	26.3	25.5	25.0	25.0	25.0	28.1	25.4	27
33	34.4	33.7	27.0	26.1	26.8	25.8	25.5	25.2	25.7	25.0	25.7	25.6	26.1	26
34	34.2	33.7	28.8	28.2	29.4	29.4	29.6	29.4	28.7	28.4	28.7	33.0	28.0	26
35	34.1	33.0	27.0	26.8	25.5	25.1	25.4	25.7	25.5	25.7	28.0	25.7	25.8	26
36	34.4	32.2	27.1	26.6	26.2	26.2	26.7	26.1	26.0	26.1	26.0	28.1	26.0	26
37	34.5	31.5	28.1	27.2	26.8	25.8	26.5	26.9	26.0	26.8	28.7	28.6	27.5	27

**Figure 39. The Temperature Table**

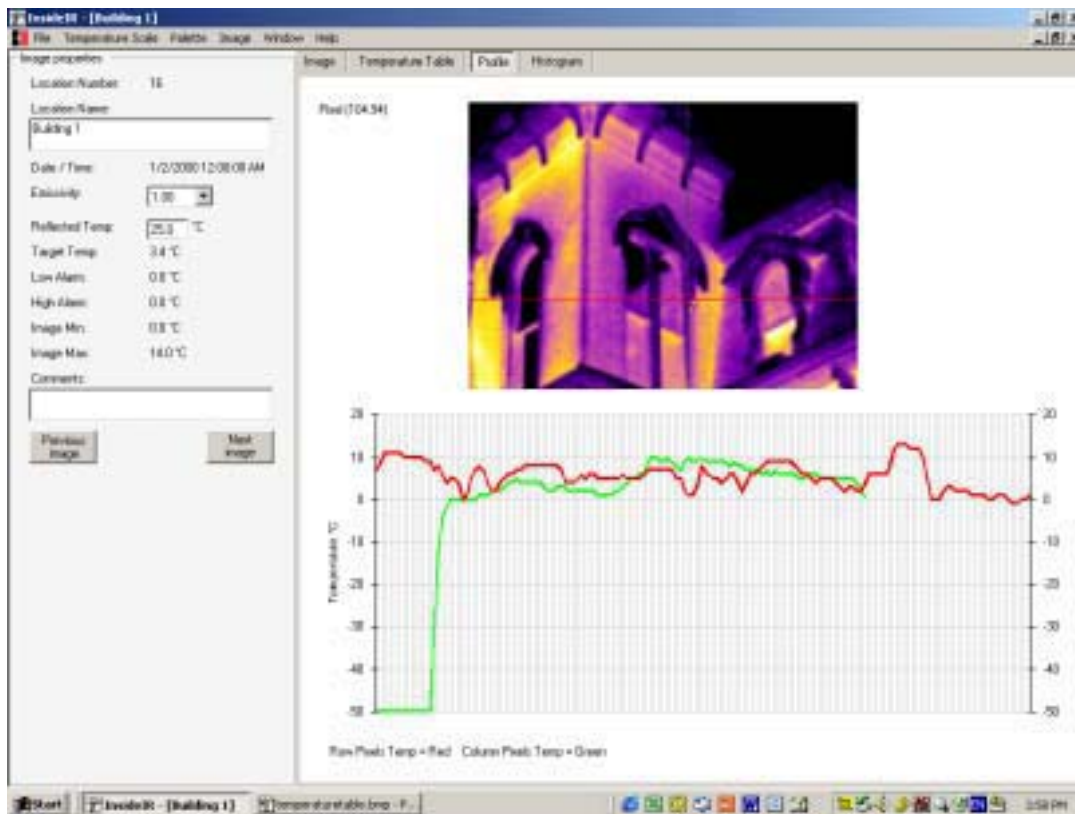
As mentioned above, this data can be saved as a .txt file, for import into a spreadsheet program for your own in-depth analysis.

**The Profile Tab**

There are two main components in the profile: an interactive radiometric thermal image on the top, and underneath it, a graph indicating the temperatures at the x and y axes of the cursor on thermal image.

Click on any portion of the thermal image on the top for the exact temperature reading at that spot. As you do this, you will see that the graph below changes, reflecting the new x and y axes as you move around the image.





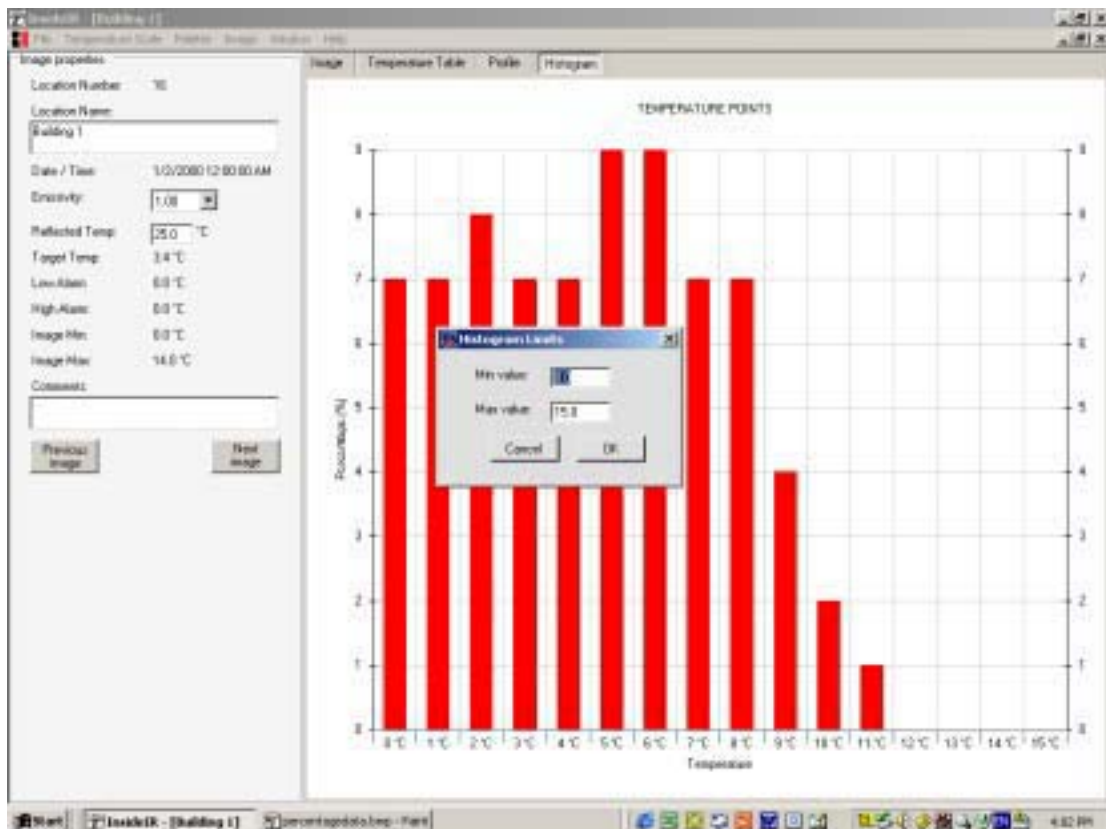
**Figure 40. The Profile Tab**

### ***The Histogram Tab***

The **Histogram** tab provides a summary of the pixel data presented on the previous screens.

The histogram displays temperature values as either a percentage of the all temperature values captured in a given thermal scene, or by number of representative pixels in the thermal scene.

To view a subset of the data, you may select **Limits** on the **Images > Histogram** menu, and enter the specific maximum and minimum temperatures for the data you are interested in graphing.



**Figure 41. The Histogram Tab – Changing the Histogram Limits**

If you wish to use the chart or chart data in another program, you may select **Copy Chart** on the **Images > Histogram** menu. The information will be saved to your Windows clipboard, and can then be pasted into Word or Excel, using either the **Paste** or **Paste Special** command.

### ***The Menu Bar***

Now that you're familiar with the concepts in the four tabs, you'll quickly understand the choices offered on the menu bar. Each menu item is briefly described below.

### ***File***

#### **New Folder**

Creates a new folder, naming it according to the date and time. The name is highlighted and editable, so you may rename it according to your own naming conventions.

**Note:** You will not see the new folder unless you are in the main window.  
ThermoView imager info



## **ThermoView Imager Info**

Product-specific information about each ThermoView Ti30 imager you have used with a specific computer. This is useful when contacting the factory for service information. It is also useful to use the name of the individual units at the highest level in your directory structure, keeping all images stored by a single unit in the same folder.

### **Exit**

Quits the application.

## ***Temperature Scale***

### **Fahrenheit**

Displays temperatures in the Fahrenheit scale.

### **Celsius**

Displays temperatures in the Celsius scale.

## ***Palette***

### **Original**

Resets specific image to the palette with which the image was originally captured.

### **Gray**

Displays selected image in gray scale

### **Rainbow**

Displays selected image in the Rainbow palette

### **Ironbow**

Displays selected image in the Ironbow palette



## **Image**

**Note:** The Image menu items are only active when at least one image is selected.

### **Export Image**

Allows you to save an image for use with another application in any of the following file formats:

- .bmp
- .jpg
- .gif
- .png
- .tiff
- .wmf
- .exif
- .emf

**Note:** When using this option, only the image is saved—the data is not.

### **Export Temperature Table**

Allows you to export the underlying pixel data from a thermal scene to a .txt file for import into a spreadsheet program, allowing you to do your own in-depth analysis

### **Create Report**

Generates a report form, pre-populating data fields with captured data from the given location. See Reporting Your Findings for additional reporting details.

### **Histogram**

Allows the user to select one of four actions specific to the data in the Histogram tab (described in previous section).

- **Copy Chart** – Saves the chart to your Windows clipboard, and can then be pasted into Word or Excel, using either the **Paste** or **Paste Special** command.
- **Pixel Data** – Displays temperature values as number of representative pixels in the thermal scene.
- **Percentage Data** - Displays temperature values as a percentage of the all temperature values captured in a given thermal scene.
- **Limits** – Allows you to view a subset of the data by entering the specific maximum and minimum temperatures for the data you are interested in graphing.



## **Copy Profile Chart**

Saves the chart from the **Profile** tab to your Windows clipboard, and can then be pasted into Word or Excel, using either the **Paste** or **Paste Special** command.

## **Window**

### **Cascade**

Cascades all open windows.

### **Tile Horizontal**

If you have more than one window open, this command will divide display them tiled horizontally.

Regardless of the number of open windows, this command will allow you to resize a window by clicking and dragging any corner of the window.

### **Tile Vertical**

If you have more than one window open, this command will divide display them tiled horizontally.

Regardless of the number of open windows, this command will allow you to resize a window by clicking and dragging any corner of the window.

## **Help**

### **Contents**

Displays InsideIR software help also contained in this manual.

### **About InsideIR**

Displays copyright information and software version number.

### **Language**

Allows you to select your language preference from English, German, French, Spanish, Portuguese, Japanese, or Chinese.

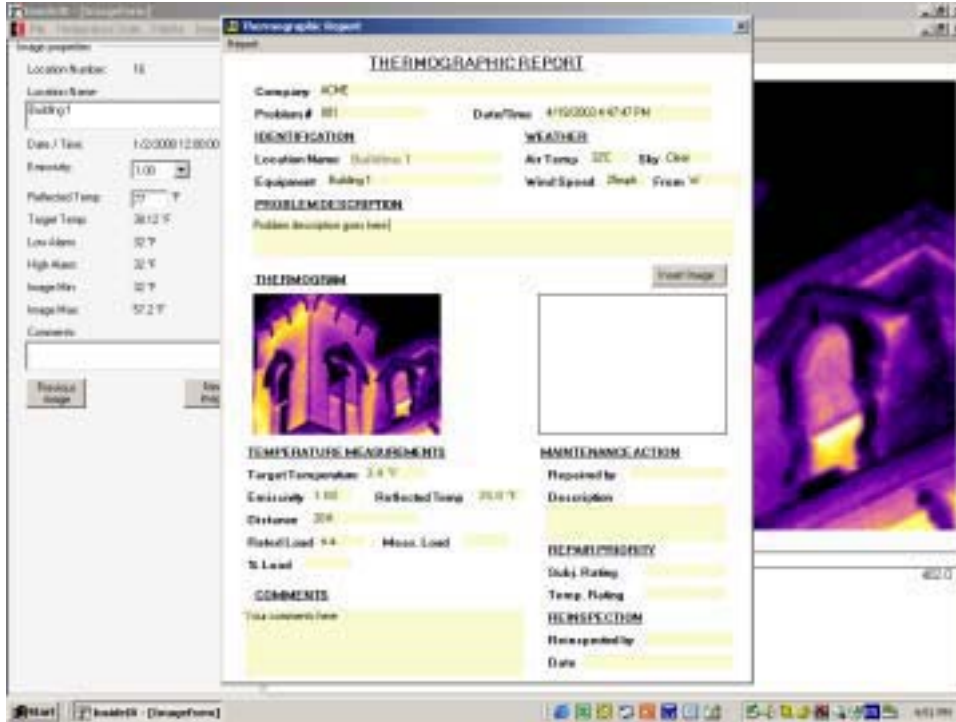
**Note:** If you select a new language, you must quit the application and restart in order for the change to take effect.





## Reporting Your Findings

The ThermoView Ti30 imager provides report forms for you to use in reporting your findings. To generate a report, you must first select an image from a given location. Then select **Image** from the **Menu Bar** and choose **Create Report** from the drop down list.



The screenshot shows a software window titled "Thermographic Report" with a form for data entry. The form is divided into several sections:

- Company:** ICHC
- Problem #:** 001
- Date/Time:** 4/15/2000 4:47:47 PM
- INVESTIGATION:** Location Name: Building 1, Equipment: Rolling 1
- WEATHER:** Air Temp: 32C, Sky: Clear, Wind Speed: 2mph, From: W
- PROBLEM DESCRIPTION:** Problem description goes here
- THERMOGRAM:** A small thermal image is shown, with an "Insert Image" button next to it.
- TEMPERATURE MEASUREMENTS:** Target Temperature: 3.4 F, Emisivity: 1.00, Reflected Temp: 75.0 F, Distance: 20ft, Risk/Loss: 54, Max. Load: % Load
- MAINTENANCE ACTION:** Reported by: Description:
- DEFERRED:** Defy. Rating: Temp. Rating:
- REVISIONS:** Reported by: Date:
- COMMENTS:** This comment area

On the left side of the window, there is a sidebar with "Image Properties" including fields for Location Number, Location Name, Emisivity, Date/Time, and various temperature readings. At the bottom, there are "Insert Image" and "Print" buttons.

**Figure 42. The Thermographic Report**

The report form is entitled "Thermographic Report." Some data is filled in for you with known data from the image file so you don't have to copy the information into the record. Also included is a copy of the image, and a space for your comments.

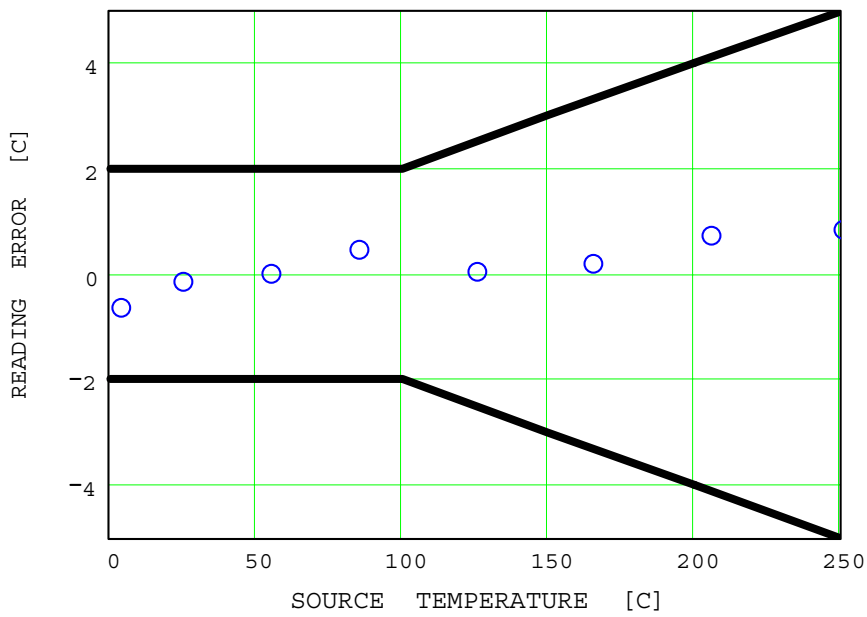
You may also attach an additional visual image (such as a digital photograph) to the report by clicking the **Insert Image** button.

Once complete, this report can be printed or saved to the clipboard from the single menu item, **Report**, on the menu bar at the top of the report window.

# Appendix A - Technical Reference

## Imager Accuracy Chart

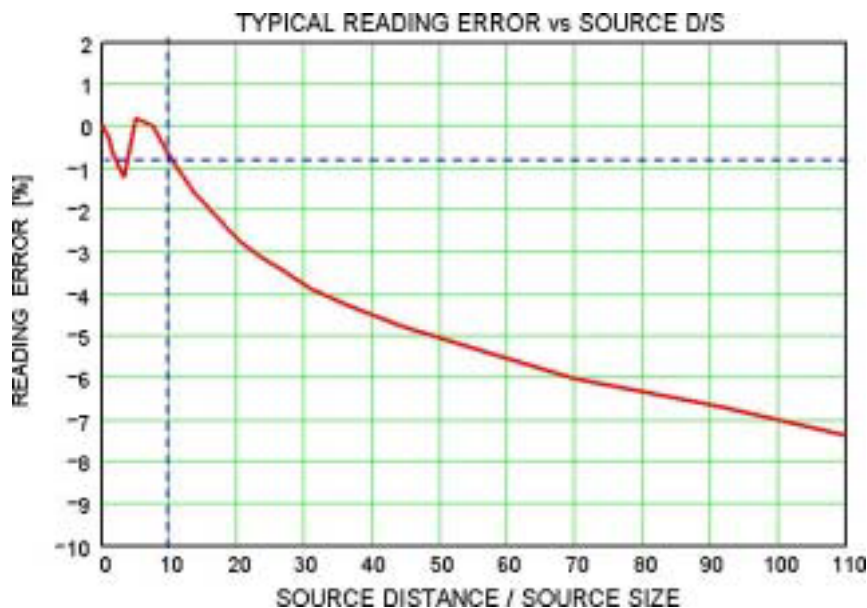
The following graph shows the measurement accuracy for a typical instrument over the measurement range of 0 – 250°C. The heavy lines show the specified accuracy.



— Specification  
○ Measured Data



## Imager Reading Error vs Source D:S



The following example uses the above Typical Reading Error vs. Source D/S graph:

A 5" diameter source (Size = 5) at a Distance of 50" has  $D/S = 50/5 = 10$ . According to the above graph the imager would read less than 1% low in temperature (as shown by the dashed line) for this size target.

## Typical Emissivity Values

The following tables provide references for estimating emissivity and can be used when the user does not have the means or the time to determine the emissivity value experimentally. Emissivity values shown in the tables are only approximate. Any or all of the following parameters can affect the emissivity of an object:

1. Temperature
2. Angle of measurement
3. Geometry (plane, concave, convex, etc.)
4. Thickness
5. Surface quality (polished, rough, oxidized, sandblasted)
6. Spectral region of measurement
7. Transmissivity (i.e., thin film plastics)

**Note 1:** These tables are to be used as a guide only, as emissivity changes with temperature, viewing angle, wavelength, target geometry and surface finish.

**Note 2:** Your ThermoView Ti30 thermal imager measures infrared energy in the 7 – 14  $\mu\text{m}$  range.



**Table 1. Emissivity Values for Metals**

Material		Emissivity		
		1.0µm	1.6µm	8-14µm
Aluminum				
	Unoxidized	0.1-0.2	0.02-0.2	n.r.
	Oxidized	0.4	0.4	0.2-0.4
	Alloy A3003,			
	Oxidized	n.r.	0.4	0.3
	Roughened	0.2-0.8	0.2-0.6	0.1-0.3
	Polished	0.1-0.2	0.02-0.1	n.r.
Brass				
	Polished	0.8-0.95	0.01-0.05	n.r.
	Burnished	n.r.	n.r.	0.3
	Oxidized	0.6	0.6	0.5
Chromium		0.4	0.4	n.r.
Copper				
	Polished	n.r.	0.03	n.r.
	Roughened	n.r.	0.05-0.2	n.r.
	Oxidized	0.2-0.8	.2-0.9	0.4-0.8
	Electrical Terminal Blocks	n.r.	n.r.	0.6
Gold		0.3	0.01-0.1	n.r.
Haynes Alloy		0.5-0.9	0.6-0.9	0.3-0.8
Inconel				
	Oxidized	0.4-0.9	0.6-0.9	0.7-0.95
	Sandblasted	0.3-0.4	0.3-0.6	0.3-0.6
	Electropolished	0.2-0.5	0.25	0.15
Iron				
	Oxidized	0.4-0.8	0.5-0.9	0.5-0.9
	Unoxidized	0.35	0.1-0.3	n.r.
	Rusted	n.r.	0.6-0.9	0.5-0.7
	Molten	0.35	0.4-0.6	n.r.
Iron, Cast				
	Oxidized	0.7-0.9	0.7-0.9	0.6-0.95
	Unoxidized	0.35	0.3	0.2
	Molten	0.35	0.3-0.4	0.2-0.3
Iron, Wrought				
	Dull	0.9	0.9	0.9
Lead				
	Polished	0.35	0.05-0.2	n.r.
	Rough	0.65	0.6	0.4
	Oxidized	n.r.	0.3-0.7	0.2-0.6
Magnesium		0.3-0.8	0.05-0.3	n.r.
Mercury		n.r.	0.05-0.15	n.r.
Molybdenum				



Material		Emissivity		
		1.0µm	1.6µm	8-14µm
	Oxidized	0.5-0.9	0.4-0.9	0.2-0.6
	Unoxidized	0.25-0.35	0.1-0.35	0.1
Monel (Ni-Cu)		0.3	0.2-0.6	0.1-0.14
Nickel				
	Oxidized	0.8-0.9	0.4-0.7	0.2-0.5
	Electrolytic	0.2-0.4	0.1-0.3	n.r.
Platinum				
	Black	n.r.	0.95	0.9
Silver		n.r.	0.02	n.r.
Steel				
	Cold-Rolled	0.8-0.9	0.8-0.9	0.7-0.9
	Ground Sheet	n.r.	n.r.	0.4-0.6
	Polished Sheet	0.35	0.25	0.1
	Molten	0.35	0.25-0.4	n.r.
	Oxidized	0.8-0.9	0.8-0.9	0.7-0.9
	Stainless	0.35	0.2-0.9	0.1-0.8
Tin (Unoxidized)		0.25	0.1-0.3	n.r.
Titanium				
	Polished	0.5-0.75	0.3-0.5	n.r.
	Oxidized	n.r.	0.6-0.8	0.5-0.6
Tungsten		n.r.	0.1-0.6	n.r.
	Polished	0.35-0.4	0.1-0.3	n.r.
Zinc				
	Oxidized	0.6	0.15	0.1
	Polished	0.5	0.05	n.r.

**Table 2. Emissivity Values for Non-Metals**

Material		Emissivity		
		1.0µm	1.6µm	8-14µm
Asbestos		0.9	0.9	0.95
Asphalt		n.r.	0.95	0.95
Basalt		n.r.	0.7	0.7
Carbon				
	Unoxidized	0.8-0.95	0.8-0.9	0.8-0.9
	Graphite	0.8-0.9	0.7-0.9	0.7-0.8
Carborundum		n.r.	0.9	0.9
Ceramic		0.4	0.85-0.95	0.95
Clay		n.r.	0.85-0.95	0.95
Concrete		0.65	0.9	0.95
Cloth		n.r.	0.95	0.95
Glass				
	Plate	n.r.	0.98	0.85



Material		Emissivity		
		1.0 $\mu$ m	1.6 $\mu$ m	8-14 $\mu$ m
	“Gob”	n.r.	0.9	n.r.
	Gravel	n.r.	0.95	0.95
	Gypsum	n.r.	0.4-0.97	0.8-0.95
	Ice	n.r.	—	0.98
	Limestone	n.r.	0.4-0.98	
	Paint (non-Al.)	—	0.9-0.95	0.9-0.95
	Paper (any color)	n.r.	0.95	0.95
	Plastic (opaque, over 20 mils)	n.r.	0.95	0.95
	Rubber	n.r.	0.9	0.95
	Sand	n.r.	0.9	0.9
	Snow	n.r.	—	0.9
	Soil	n.r.	—	0.9-0.98
	Water	n.r.	—	0.93
	Wood, Natural	n.r.	0.9-0.95	

To optimize surface temperature measurement accuracy consider the following:

1. Determine the object emissivity for the spectral range of the instrument to be used for the measurement.
2. Avoid reflections by shielding object from surrounding high temperature sources.
3. For higher temperature objects use shorter wavelength instruments, whenever possible.
4. For semi-transparent materials such as plastic film and glass, assure that the background is uniform and lower in temperature than the object.
5. Hold instrument perpendicular to surface whenever emissivity is less than 0.9. In all cases, do not exceed angles more than 30 degrees from incidence.



## Appendix B – Infrared Theory Q&A

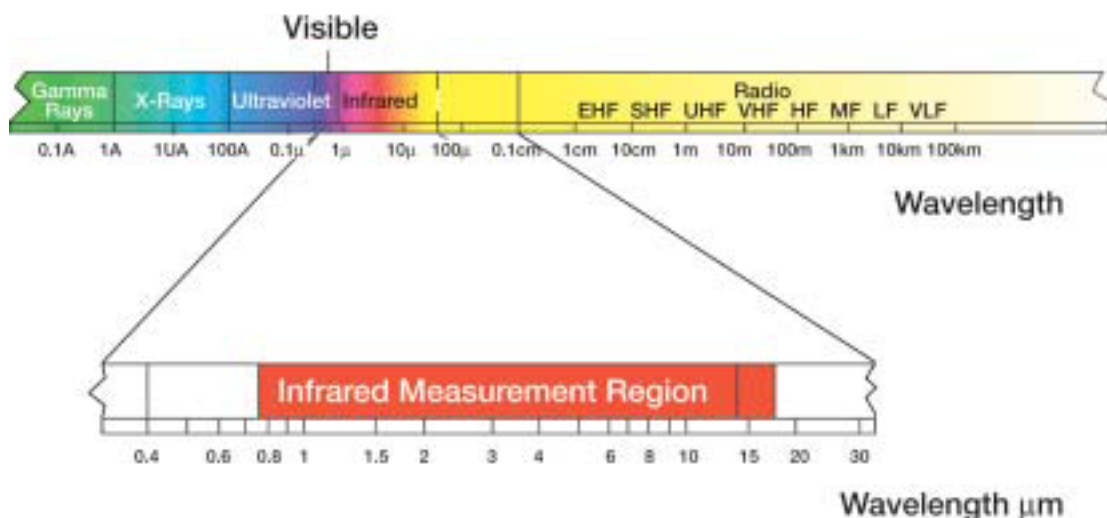
### Q. Why use noncontact infrared thermometers?

A. Noncontact infrared (IR) thermometers use infrared technology to quickly and conveniently measure the surface temperature of objects. They provide fast temperature readings without physically touching the object. The temperature is shown on the LCD display.

Lightweight, compact, and easy-to-use, IR thermometers and thermal imagers can safely measure hot, hazardous, or hard-to-reach surfaces without contaminating or damaging the object. Also, infrared thermometers can provide several readings per second, as compared to contact methods where each measurement can take several minutes.

### Q. How does IR work?

A. IR thermometers capture the invisible infrared energy naturally emitted from all objects. Infrared radiation is part of the electromagnetic spectrum, which includes radio waves, microwaves, visible light, ultraviolet, gamma, and X-rays.



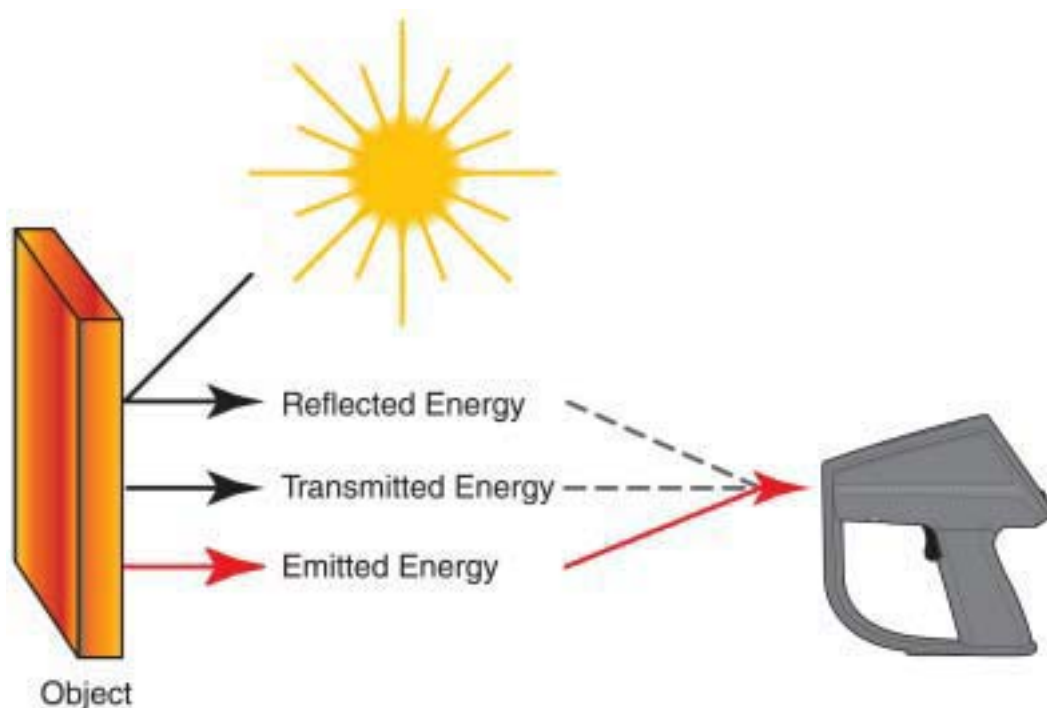
Infrared falls between the visible light of the spectrum and radio waves. Infrared wavelengths are usually expressed in microns with the infrared spectrum extending from 0.7 microns to 1000 microns. In practice, the 0.7 to 14 micron band is used for IR temperature measurement.

## Q. How to assure accurate temperature measurement?

A. A solid understanding of infrared technology and its principles lies behind accurate temperature measurement. When the temperature is measured by a non-contact device the IR energy emitted from the measured object passes through the optical system of the thermometer or thermal imager and is converted to an electrical signal at the detector. This signal is then displayed as a temperature reading and/ or thermal image. There are several important factors that determine accurate measurement. The most important factors are emissivity, distance to spot ratio, and field- of-view.

### Emissivity

All objects reflect, transmit and emit energy. Only the emitted energy indicates the temperature of the object. When IR thermometers or thermal imagers measure the surface temperature they sense all three kinds of energy, therefore all thermometers have to be adjusted to read emitted energy only. Measuring errors are often caused by IR energy being reflected by light sources.



Some IR thermometers and thermal imagers allow you to change the emissivity in the unit. The value of emissivity for various materials can be looked up in published emissivity tables.

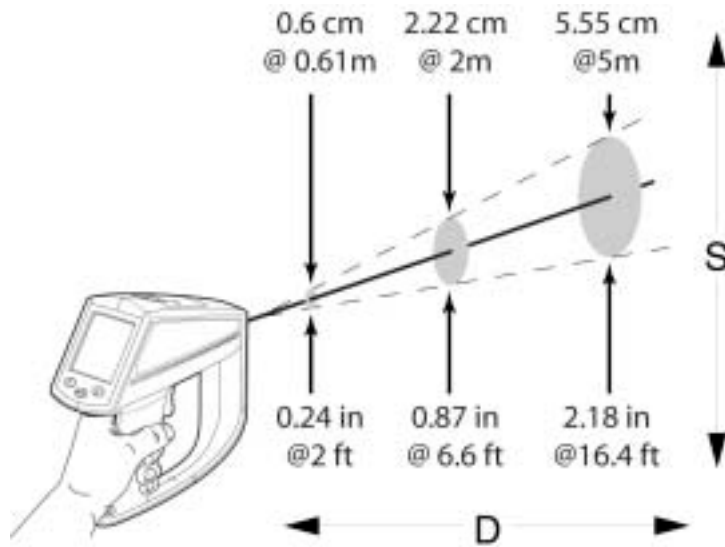
Other units have a fixed, pre-set emissivity of 0.95, which is the emissivity value for most organic materials and painted or oxidized surfaces. If you are using a thermometer or thermal imager with a fixed emissivity to measure the surface



temperature of a shiny object you can compensate by covering the surface to be measured with masking tape or flat black paint. Allow time for the tape or paint to reach the same temperature as the material underneath. Measure the temperature of the taped or painted surface. That is the true temperature.

### Distance to spot ratio

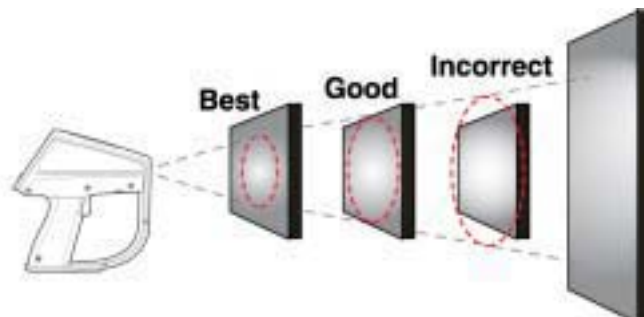
The optical system of an infrared thermometer collects the infrared energy from a circular measurement spot and focuses it on the detector. Optical resolution is defined by the ratio of the distance from instrument to the object compared to the size of the spot being measured (D:S ratio). The larger the ratio number the better the instrument's resolution, and the smaller the spot size that can be measured. The laser sighting included in some instruments only helps to aim at the measured spot.



A recent innovation in infrared optics is the addition of a Close Focus feature, which provides accurate measurement of small target areas without including unwanted background temperatures.

### Field-of-view.

Make sure that the target is larger than the spot size the unit is measuring. The smaller the target, the closer you should be to it. When accuracy is critical make sure



July 1, 2003

Version 1.0



that the target is at least twice as large as the spot size.

#### Q. How to take temperature measurement?

A. To take a temperature measurement, just point the unit at the object you wish to measure. Be sure to consider distance-to-spot size ratio and field of view. There are important things to keep in mind while using infrared thermometers:

1. **Measure surface temperature only.** The IR thermometer cannot measure internal temperatures.
2. **Do not take temperature measurement through glass.** Glass has very distinctive reflection and transmission properties that do not allow accurate infrared temperature reading. Infrared thermometers are not recommended for use in measuring shiny or polished metal surfaces (stainless steel, aluminum, etc.). (See Emissivity.)
3. **Watch for environmental conditions.** Steam, dust, smoke, etc., can prevent accurate measurement by obstructing the unit's optics.
4. **Watch for ambient temperatures.** If the thermometer is exposed to abrupt ambient temperature differences of 10 degrees or more, allow it to adjust to the new ambient temperature for at least twenty minutes.

#### Q. What are the most popular applications?

A. Non-contact thermometers have many uses. The most popular include:

1. **Predictive and Preventive Industrial Maintenance:** check transformers, electrical panels, connectors, switchgear, rotating equipment, furnaces and much more.
2. **Automotive:** Diagnose cylinder heads and heating/cooling systems.
3. **HVAC/R:** Monitor air stratification, supply/return registers and furnace performance.
4. **Food Service & Safety:** Scan holding, serving, and storage temperatures.
5. **Process Control & Monitoring:** check process temperature of steel, glass, plastics, cement, paper, food & beverage.

For additional information on applications for non-contact IR thermometers visit our website at [www.raytek.com](http://www.raytek.com).



# Glossary

## **Absolute Zero**

The temperature (0 Kelvin) of an object defined by the theoretical condition where the object has zero energy.

## **Accuracy**

Maximum deviation, expressed in temperature units, or as a percentage of the temperature reading, or as a percentage of the full scale temperature value, or as a percentage of the target temperature, indicating the difference between a temperature reading given by an instrument under ideal operating conditions, and the temperature of a calibration source (per the ASTM standard test method E 1256-88).

## **Ambient Derating**

Refer to Temperature Coefficient.

## **Ambient Operating Range**

Range of the ambient temperature conditions over which the thermometer is designed to operate.

## **Ambient Temperature**

Ambient temperature is the room temperature or temperature surrounding the instrument.

## **Ambient Temperature Compensation (TAMB)**

Refer to Reflected Energy Compensation.

## **ASTM**

ASTM is an abbreviation for American Society for Testing and Materials.

## **Atmospheric Windows**

The Atmospheric Windows is the infrared spectral bands in which the atmosphere best transmits radiant energy. Two pre-dominant windows are located at 2-5  $\mu\text{m}$  and at 8-14  $\mu\text{m}$ .



## **Background Temperature**

Temperature behind and surrounding the target, as viewed from the instrument.

## **Blackbody**

A perfect emitter; an object that absorbs all the radiant energy incident on it at all wavelengths and reflects and transmits none. A surface with emissivity of unity (1.00).

## **°C (Celsius)**

Temperature scale based on 0° (zero degrees) as the freezing point of water, and 100° as the vaporization point of water, at standard pressure.

$$^{\circ}\text{C} = \frac{^{\circ}\text{F} - 32}{1.8}$$

## **Calibration**

A methodical measurement procedure to determine all the parameters significantly affecting an instrument's performance.

## **Calibration Source**

A source (blackbody, hot plate, etc.) of known and traceable temperature and emissivity. Usually NIST traceable in the USA, with other recognized standards available for international customers.

## **Colored Body**

See Non-Gray Body.

## **D:S**

Distance to size ratio. See Optical Resolution.

## **Detector**

A transducer which produces a voltage or current proportional to the IR energy incident upon it. See also thermopile, pyroelectric, and Si detectors.

## **DIN**

Deutsches Institut für Normung (DIN) is the German standard for many instrumentation products.

July 1, 2003

- 76 -

Version 1.0



## **Display Resolution**

The level of precision to which a temperature value can be displayed, usually expressed in degrees or tenths of degrees.

## **Drift**

The change in instrument indication over a long period of time, not caused by external influences on the device (per the ASTM standard test method E 1256-88).

## **EMC**

Electro-Magnetic Compatibility is the resistance to electrical signal disturbances within IR thermometers.

## **Emissivity**

Emissivity is the ratio of infrared energy radiated by an object at a given temperature and spectral band to the energy emitted by a perfect radiator (blackbody) at the same temperature and spectral band. The emissivity of a perfect blackbody is unity (1.00).

## **EMI/RFI Noise**

Electro-Magnetic Interference/Radio Frequency Interference (EMI and RFI) may cause disturbances to electrical signals within IR thermometers. EMI and RFI noise is most commonly caused by devices by switching motors (air conditioners, power tools, refrigeration systems, etc.).

## **°F (Fahrenheit)**

Temperature scale where  $^{\circ}\text{F} = (^{\circ}\text{C} \times 1.8) + 32 = ^{\circ}\text{R} - 459.67$ .

## **Far Field**

A measured distance substantially greater than the focus distance of the instrument; typically greater than 10 times the focus distance.

## **Field of View (FOV)**

The region, at the target, measured by the IR thermometer. Typically presented by giving the spot diameter as a function of distance from the instrument. Also presented as the angular size of the spot at the focus point.

See Optical Resolution.



**Focus Point (or Distance)**

The distance from the instrument where the optical resolution is greatest.

**Full Scale**

The maximum of the temperature range or output signal.

**Full Scale Accuracy**

A convention for expressing the accuracy as percentage of an instrument's (highest) full-scale temperature.

**Gray Body**

A radiating object whose emissivity is in constant ratio (not unity) at all wavelengths to that of a blackbody at the same temperature, and does not transmit infrared energy.

**HAL**

High Alarm. Units with this feature can sound an alarm when they sense that a user-defined high temperature has been reached.

**Hertz (Hz)**

Units in which frequency is expressed. Synonymous with cycles per second.

**Infrared (IR)**

The portion of the electromagnetic spectrum extending from the far red visible at approximately 0.75  $\mu\text{m}$ , out to 1000  $\mu\text{m}$ . However, because of instrument design considerations and the atmospheric windows, most infrared measurements are made between 0.75  $\mu\text{m}$  and 20  $\mu\text{m}$ .

**Infrared Thermometer**

An instrument that converts incoming IR radiation from a spot on a target surface to a measurement value that can be related to the temperature of that spot.

**K (Kelvin)**

The unit of absolute or thermodynamic temperature scale where 0 K is absolute zero and 273.15 K is equal to 0° C. There is no (°) symbol used with the Kelvin scale, and  $K = ^\circ\text{C} + 273.15$ .



## **LAL**

Low Alarm. Units with this feature can sound an alarm when they sense that a user-defined low temperature has been reached.

## **Laser**

Single or dual lasers are used in some units for aiming and/or locating the optimum temperature measurement point.

## **LOC**

Location. Units with the data-logging feature store data in numbered locations, which can be recalled and reviewed on the display when necessary.

## **Loop**

A cycle of operations within a selected mode. For example, the RUN Loop cycles through standard running operations; the LOG Loop cycles through data logging operations; and the RECALL Loop cycles through stored operations and displays the data.

## **Micron (or $\mu\text{m}$ )**

$10^{-6}$  meters (m), or 0.000001 m.

## **Minimum spot size**

The smallest spot an instrument can accurately measure.

## **Mode**

Modes are various user-selectable operations within Loops.

## **NETD**

Noise Equivalent Temperature Difference. Peak to peak system electrical noise normally measured at the output (display or analog) expressed in °F or °C.

## **NIST Traceability**

Calibration in accordance with and against standards traceable to NIST (National Institute of Standards and Technology, USA). Traceability to NIST is a means of ensuring that reference standards remain valid and their calibration remains current.



### **Non-Gray Body**

A radiating object that is partly transparent to infrared (transmits infrared energy at certain wavelengths); also called Colored Bodies. Glass and plastic films are examples of non-gray bodies.

### **Optical Pyrometer**

A system that, by comparing a source whose temperature is to be measured to a standardized source of illumination (usually compared to the human eye), determines the temperature of the former source.

### **Optical Resolution**

The distance to size ratio (D:S) of the IR measurement spot, where the distance is usually defined at the focus distance, and the size is defined by the diameter of the IR energy spot at the focus (typically at the 90% IR energy spot diameter). Optical resolution may also be specified for the far field by using values of far field distance and spot size.

### **Pyroelectric Detector**

Infrared detector that behaves as a current source with an output proportional to the rate of change of the incident IR energy.

### **°R (Rankine)**

Temperature scale where  $^{\circ}\text{R} = 1.8 \times \text{K}$ , or also  $^{\circ}\text{R} = ^{\circ}\text{F} + 460$ .

### **Radiation Thermometer**

A device that calculates an object's temperature (given a known emissivity) from measurement of either visible or infrared radiation from that object.

### **Recall (RCL)**

When the Recall loop is activated, stored values can be recalled from either the RUN or LOG loops.

### **Reflectance**

The ratio of the radiant energy reflected off a surface to that incident on the surface; for a gray body this is equal to unity minus emittance; for a perfect mirror this approaches unity; and for a blackbody the reflectance is zero.





## **Reflected Temperature Compensation**

Correction feature used to achieve greater accuracy when, due to a high uniform background temperature, IR energy is reflected off the target into the instrument. If the background temperature is known the instrument reading can be corrected by using this feature. Targets that have low emissivities will reflect energy from nearby objects, which may result in inaccurate readings. Sometimes objects near the target (machines, furnaces, or other heat sources) have a temperature much higher than that of the target. In these situations it is necessary to compensate for the reflected energy from those objects. (RTC has no effect if the emissivity is 1.0.)

## **Relative Humidity**

The ratio, expressed as a percent, of the amount of water vapor actually present in a sample of air to the greatest amount of water vapor possible at the same temperature.

## **Repeatability**

The degree to which a single instrument gives the same reading on the same object over successive measures under the same ambient and target conditions (per the ASTM standard test method E 1256-88).

## **Resolution**

See Temperature Resolution or Optical Resolution.

## **Response Time**

A measure of an instrument's change of out-put corresponding to an instantaneous change in target temperature, generally expressed in milli-seconds, for 95 percent of full scale temperature indication (per the ASTM standard test method E 1256-88). The specification for Raytek instruments also includes the average time required for software computations.

## **Scatter**

See Size of Source Effect.

## **Size of Source Effect**

An undesirable increase in temperature reading caused by IR energy outside the spot reaching the detector. The effect is most pronounced when the target is much larger than the field of view.



## **Spectral Response**

The wavelength region in which the IR Thermometer is sensitive.

## **Spot**

The diameter of the area on the target where the temperature determination is made. The spot is defined by the circular aperture at the target that allows typically 90% of the IR energy to be collected by the instrument, as compared with the 100% spot diameter which is defined by the IR energy collected from a very large target. The actual size and distance to the target for the 100% spot diameter is specified in the calibration procedure for each instrument.

## **Stare**

A saturation effect caused by aiming a sensor at a *hot* target for an extended period of time and then quickly aiming at a target at a *lower* temperature. The increase in time (beyond the normal system response) for the sensor to return to within 5 % of the lower temperature is defined as the *stare* time.

## **Storage Temperature Range**

Ambient temperature range that the thermometer can safely withstand in a non-operating mode, and subsequently, operate with-in published performance specifications.

## **Target**

The object upon which the temperature determination is being made.

## **Temperature**

A degree of hotness or coldness of an object measurable by a specific scale; where heat is defined as thermal energy in transit, and flows from objects of higher temperature to objects of lower temperature.

## **Temperature Coefficient (or Ambient Derating)**

An indication of the instruments ability to maintain accuracy when the ambient conditions are subject to a slow change or drift. The temperature coefficient is usually expressed as the percent change in accuracy per degree change in ambient temperature. For a rapid change in ambient conditions refer to Thermal Shock.



### **Temperature Resolution**

The minimum simulated or actual change in target temperature that gives a usable change in output and/or indication (per the ASTM standard test method E 1256-88).

### **Thermal Shock**

A short-term error in accuracy caused by a transient ambient temperature change. The instrument recovers from its accuracy error when it comes back into equilibrium with the new ambient conditions.

### **Time Constant**

The time it takes for a sensing element to respond to 63.2% of a step change at the target.

### **Transfer Standard**

A precision radiometric measurement instrument with NIST traceable calibration in the USA (with other recognized standards available for international customers) used to calibrate radiation reference sources.

### **Transmittance**

The ratio of IR radiant energy transmitted through an object to the total IR energy received by the object for any given spectral range; the sum of emittance, reflectance, and transmittance is unity.

### **Warm-Up Time**

Time, after turn on, until the instrument will function within specified repeatability (per the ASTM standard test method E 1256-88).

