

JBL

JBL VENUE™

SUB10 (120V)

OWNER'S GUIDE



READ FIRST! Important Safety Precautions!

CAUTION

RISK OF ELECTRIC SHOCK DO NOT OPEN

CAUTION: To reduce the risk of electric shock, do not remove cover (or back). No user-serviceable parts inside. Refer servicing to qualified service personnel.

CAUTION: To prevent electric shock, do not use this (polarized) plug with an extension cord, receptacle or other outlet unless the blades can be fully inserted to prevent blade exposure.



The lightning flash with arrowhead symbol, within an equilateral triangle, is intended to alert the user to the presence of uninsulated "dangerous voltage" within the product's enclosure that may be of sufficient magnitude to constitute a risk of electric shock to persons.



The exclamation point within an equilateral triangle is intended to alert the user to the presence of important operating and maintenance (servicing) instructions in the literature accompanying the appliance.

1. Read these instructions.
2. Keep these instructions.
3. Read all warnings.
4. Follow all instructions.
5. Do not use this apparatus near water.
6. Clean only with a dry cloth.
7. Do not block any ventilation openings. Install in accordance with the manufacturer's instructions.
8. Do not install near any heat sources such as radiators, heat registers, stoves or other apparatus (including amplifiers) that produce heat.
9. Do not defeat the safety purpose of the polarized or grounding-type plug. A polarized plug has two blades with one wider than the other. A grounding-type plug has two blades and a third grounding prong. The wide blade or the third prong are provided for your safety. If the provided plug does not fit into your outlet, consult an electrician for replacement of the obsolete outlet.
10. Protect the power cord from being walked on or pinched, particularly at plugs, convenience receptacles and the point where they exit from the apparatus.
11. Only use attachments/accessories specified by the manufacturer.
12. Use only with the cart, stand, tripod, bracket or table specified by the manufacturer or sold with the apparatus. When a cart is used, use caution when moving the cart/apparatus combination to avoid injury from tip-over.



13. Unplug this apparatus during lightning storms or when unused for long periods of time.
14. Refer all servicing to qualified service personnel. Servicing is required when the apparatus has been damaged in any way, such as power-supply cord or plug is damaged, liquid has been spilled or objects have fallen into the apparatus, the apparatus has been exposed to rain or moisture, does not operate normally, or has been dropped.
15. Do not use attachments not recommended by the product manufacturer, as they may cause hazards.
16. This product should be operated only from the type of power source indicated on the marking label. If you are not sure of the type of power supply to your home, consult your product dealer or local power company. For products intended to operate from battery power or other sources, refer to the operating instructions.
17. If an outside antenna or cable system is connected to the product, be sure the antenna or cable system is grounded so as to provide some protection against voltage surges and built-up static charges. Article 810 of the National Electrical Code, ANSI/NFPA 70, provides information with regard to proper grounding of the mast and supporting structure, grounding of the lead-in wire to an antenna discharge unit, size of grounding conductors, location of antenna-discharge unit, connection to grounding electrodes, and requirements for the grounding electrode. See Figure A.
18. An outside antenna system should not be located in the vicinity of overhead power lines or other electric light or power circuits, or where it can fall into such power lines or circuits. When installing an outside antenna system, extreme care should be taken to keep from touching such power lines or circuits, as contact with them might be fatal.

19. Do not overload wall outlets, extension cords, or integral convenience receptacles, as this can result in a risk of fire or electric shock.
20. Never push objects of any kind into this product through openings, as they may touch dangerous voltage points or short-out parts, which could result in a fire or electric shock. Never spill liquid of any kind on the product.
21. The apparatus shall not be exposed to dripping or splashing, and no objects filled with liquids, such as vases, shall be placed on the apparatus.
22. Do not attempt to service this product yourself, as opening or removing covers may expose you to dangerous voltage or other hazards. Refer all servicing to qualified service personnel.
23. When replacement parts are required, be sure the service technician has used replacement parts specified by the manufacturer or that have the same characteristics as the original part. Unauthorized substitutions may result in fire, electric shock or other hazards.
24. Upon completion of any service or repairs to this product, ask the service technician to perform safety checks to determine that the product is in proper operating condition.
25. The product should be mounted to a wall or ceiling only as recommended by the manufacturer.

Figure A.
Example of Antenna Grounding as per
National Electrical Code ANSI/NFPA 70

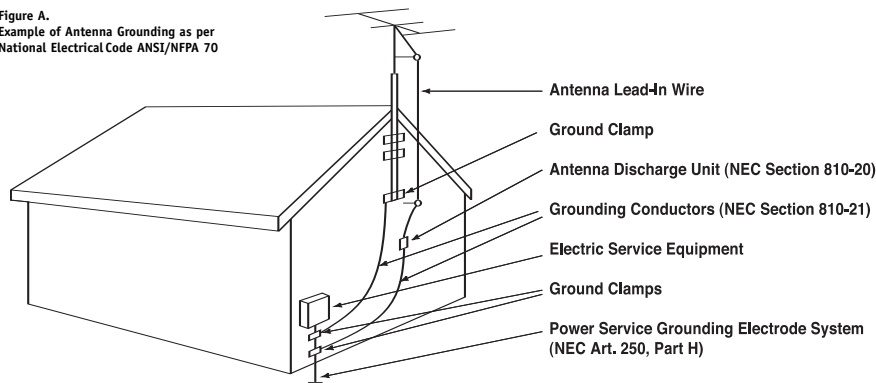

INTRODUCTION

JBL® SUB10 Powered Subwoofer

For more than 60 years, JBL has been providing audio equipment to concert halls, recording studios and movie theaters around the world, and has become the hands-down choice of leading recording artists and sound engineers.

With the JBL Venue™ Series, innovative technologies such as titanium-laminate-dome tweeters, EOS™ waveguides and PolyPlas™ transducer reinforcement are available to you. Enjoy!

Unpacking the Subwoofer

If you suspect damage from transit, report it immediately to your dealer. Keep the shipping carton and packing materials for future use.

PLACEMENT

Since the installation of a subwoofer can be somewhat more complicated than installation of full-range speakers, it is essential that you read this section very carefully prior to connecting the subwoofer to your system. Should you have questions relating to your installation, it is advisable to call either your dealer or JBL's Customer Service Department for advice.

The performance of the subwoofer is directly related to its placement in the listening room and how you align the subwoofer with its satellite speakers. Setting the volume of the subwoofer in relationship to the left and right speakers is also of critical importance because it is essential that the subwoofer integrate smoothly with the entire system. Setting the subwoofer's volume level too high will result in overpowering, boomy bass. Setting the volume level too low will negate the benefits of the subwoofer.

Here are several additional facts on installation that may prove useful. It is generally believed by most audio authorities that low frequencies (below 125Hz) are nondirectional and, therefore, placement of a subwoofer within any listening room is not critical. While in theory it is true that the larger wavelengths of extremely low frequencies are basically nondirectional, the fact is that, when installing a subwoofer within the limited confines of a room, reflections, standing waves and absorptions generated within the room will strongly influence the performance of any subwoofer system. As a result, specific location of the subwoofer becomes important, and we strongly recommend that you experiment with placement before choosing a final location.

Placement will depend upon your room and the amount and quality of bass required (for example, whether or not your room permits placement of the subwoofer near either satellite).

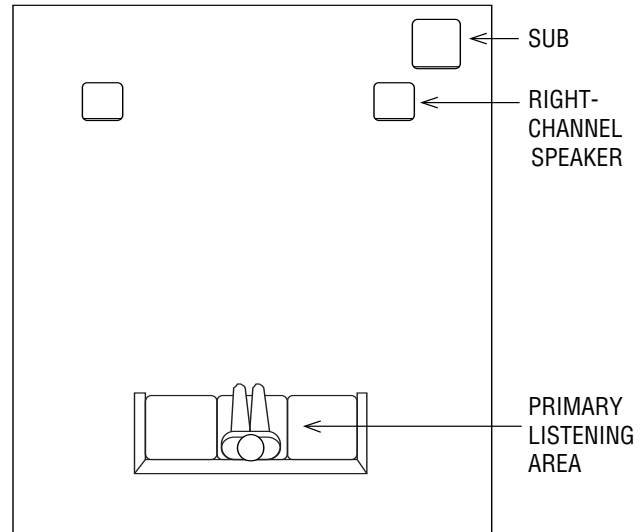
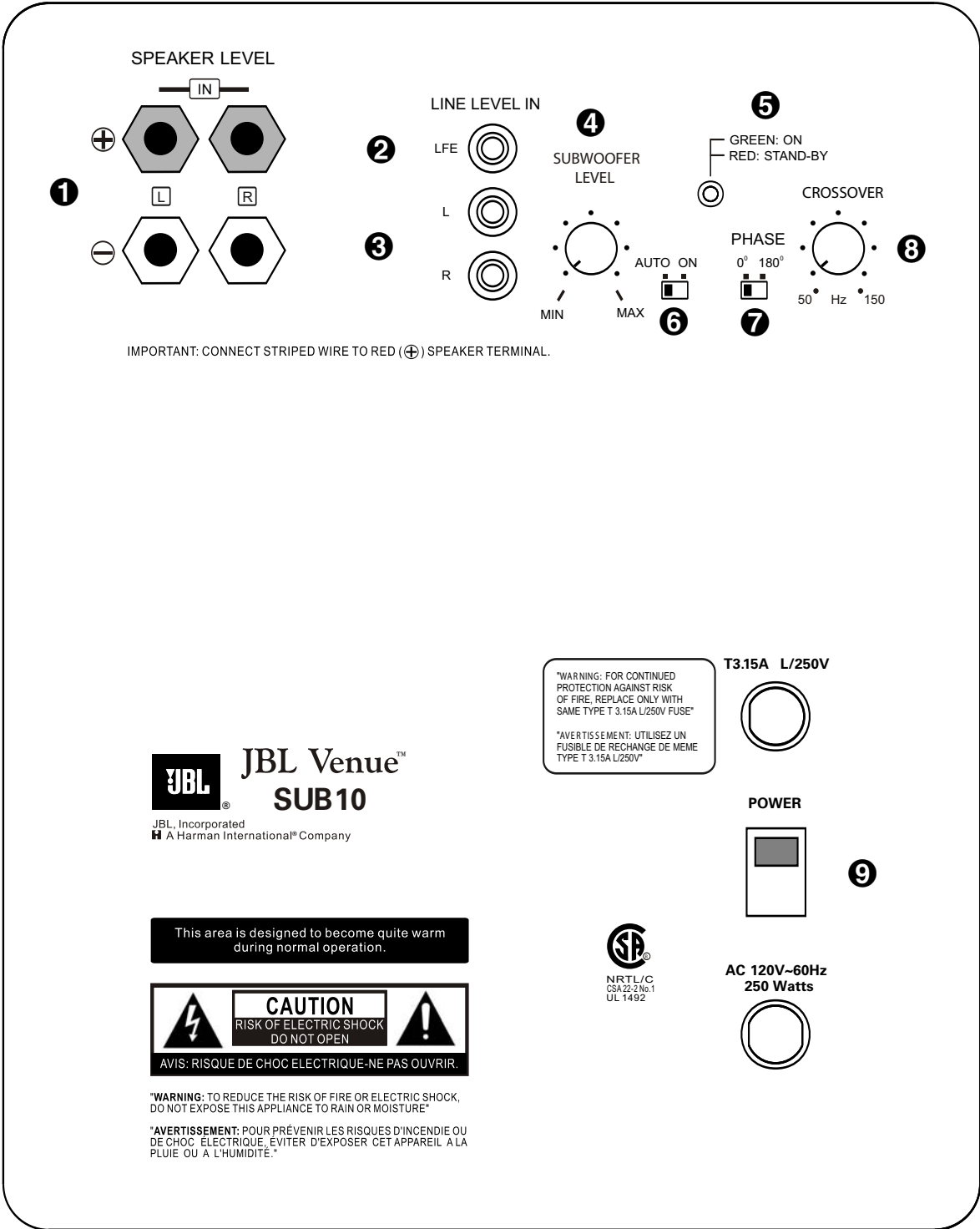

Figure 1. This example shows the subwoofer positioned behind the right-channel satellite speaker to re-create the actual location of bass instruments in an orchestra and/or add impact to movie soundtracks.



1 Speaker-Level Inputs

2 LFE Input

3 Line Inputs

4 Subwoofer-Level Control

5 Power Indicator LED

6 On/Off Auto Switch

7 Phase Switch

8 Crossover Adjustment

9 Power Switch

SYSTEM CONNECTIONS

If you have a Dolby® Digital or DTS® receiver/processor with a low-frequency-effects (LFE) or subwoofer output:

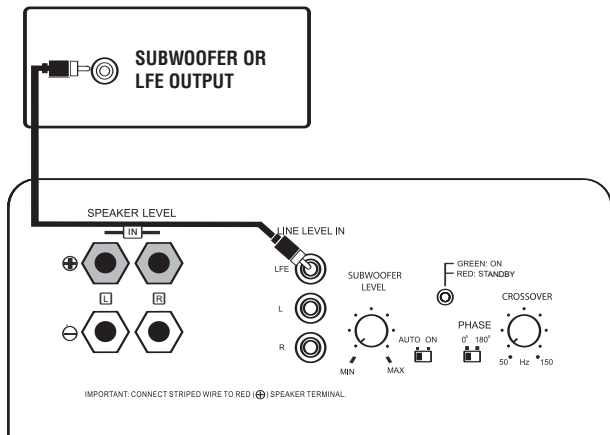

If your receiver/processor does not contain a Dolby Digital or DTS processor but has subwoofer outputs:

NOTE: If your receiver/processor has only one sub out, you may use either the L or R input.

RECEIVER/PROCESSOR

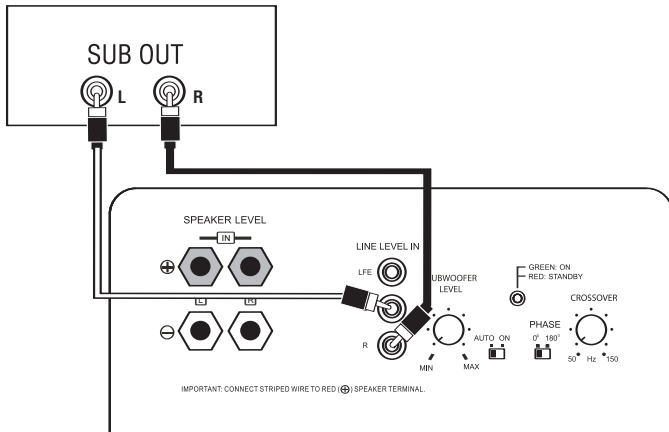

If your receiver/processor does not have subwoofer outputs for the left and right channels or an LFE output, connect speaker wire from your receiver/amplifier to your speakers and subwoofer using two sets of speaker wire:

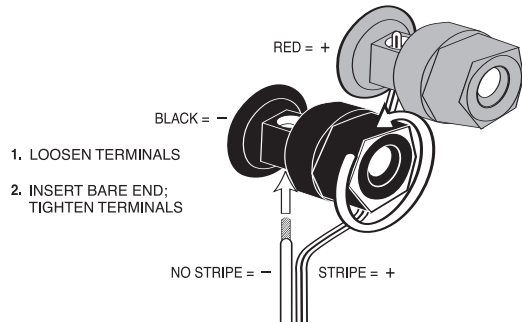
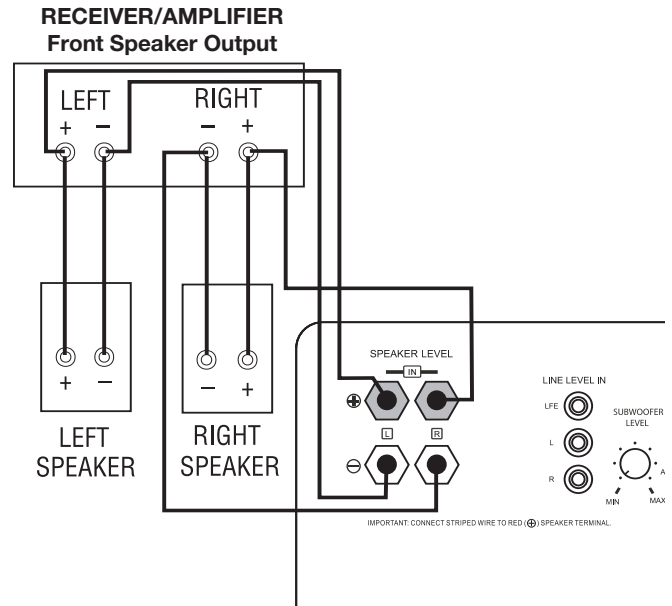

This figure shows how to connect bare wires to the speaker-level terminals.

OPERATION

Power On

Plug your subwoofer's AC cord into a wall outlet. Do not use the outlets on the back of the receiver.

Initially set the Subwoofer-Level Control ④ to the "min" position.

Turn on your sub by pressing the Power Switch ⑨ on the rear panel.

Turn on your entire audio system and start a CD or movie soundtrack at a moderate level.

Auto On/Standby

With the Power Switch ⑨ in the "on" position, the Power Indicator LED ⑤ will remain backlit in red or green to indicate the On/Standby mode of the subwoofer.

RED = STANDBY (No signal detected, Amp Off)

GREEN = ON (Signal detected, Amp On)

When the Auto Switch ⑥ is in the "auto" position, the subwoofer will automatically enter the Standby mode after approximately 10 minutes when no signal is detected from your system. The subwoofer will then power ON instantly when a signal is detected. During periods of normal use, the Power Switch ⑨ may be left on. You may turn off the Power Switch ⑨ for extended periods of non-operation, e.g., when you are away on vacation. If the Auto Switch ⑥ is in the "on" position, the subwoofer will remain on.

Adjust Gain

Turn your Subwoofer-Level Control ④ up to the halfway position. If no sound emanates from the subwoofer, check the AC-line cord and input cables. Are the connectors on the cables making proper contact? Is the AC plug connected to a "live" receptacle? Has the Power Switch ⑨ been pressed to the "on" position? Once you have confirmed that the subwoofer is active, proceed by playing a CD, record or cassette. Use a selection that has ample bass information.

Set the overall volume control of the preamplifier or stereo to a comfortable level. Adjust the Subwoofer-Level Control ④ until you obtain a pleasing blend of bass. Bass response should not overpower the room but rather be adjusted so there is a harmonious blend across the entire musical range. Many users have a tendency to set the subwoofer volume too loud, adhering to the belief that a subwoofer is there to produce lots of bass. This is not entirely true. A subwoofer is there to enhance bass, extending the response of the entire system so the bass can be felt as well as heard. However, overall balance must be maintained or the music will not sound natural. An experienced listener will set the volume of the subwoofer so its impact on bass response is always there but never obtrusive.

Phase Control

The Phase Switch ⑦ determines whether the subwoofer speaker's pistonlike action moves in and out with the main speakers, 0°, or opposite the main speakers, 180°. Proper phase adjustment depends on several variables such as room size, subwoofer placement and listener position. Adjust the Phase Switch to ⑦ maximize bass output at the listening position.

Crossover Adjustment

The Crossover Adjustment Control ⑧ determines the highest frequency at which the subwoofer reproduces sounds. If your main speakers can comfortably reproduce some low-frequency sounds, set this control to a lower frequency setting, between 50Hz and 100Hz. This will concentrate the subwoofer's efforts on the ultradeep bass sounds required by today's films and music.

If you are using smaller bookshelf speakers that do not extend to the lower bass frequencies, set the Crossover Adjustment Control ⑧ to a higher setting, between 120Hz and 150Hz.

NOTE: This control will have no effect if the LFE/Input ② is used. If you have a Dolby Digital or DTS processor/receiver, the low-pass frequency is set by the processor/receiver. Consult your owner's manual to learn how to view or change this setting.

MAINTENANCE AND SERVICE

The enclosure may be cleaned using a soft cloth to remove fingerprints or to wipe off dust.

The grille may be gently vacuumed. Stains may be removed with an aerosol cleaner, following its instructions. Do not use any solvents on the grille.

All wiring connections should be inspected and cleaned or remade periodically. The frequency of maintenance depends on the metals involved in the connections, atmospheric conditions and other factors, but once per year is the minimum.

If a problem occurs, make sure that all connections are properly made and clean. If a problem exists in one loudspeaker, reverse the connection wires to the left and right system. If the problem remains in the same speaker, then the fault is with the loudspeaker. If the problem appears in the opposite speaker, the cause is in another component or cable. In the event that your subwoofer ever needs service, contact your local JBL dealer or www.jbl.com for a service center near you.

SPECIFICATIONS

SUB10

Frequency Response	27Hz – 150Hz
Amplifier RMS Power	150 Watts
Amplifier Peak Dynamic Power†	300 Watts
Crossover Frequencies	50Hz – 150Hz, 24dB/octave, continuously variable
Driver	10" (250mm) PolyPlas™
Dimensions (H x W x D) (with grille)	17-3/4" x 12-1/4" x 15-3/4" (451mm x 311mm x 400mm)
Weight	32.1 lb (14.6kg)

† The Peak Dynamic Power is measured by recording the highest center-to-peak voltage measured across the output of a resistive load equal to minimum impedance of the transducer, using a 50Hz sine wave burst, 3 cycles on, 17 cycles off.

All features and specifications are subject to change without notice.

JBL and Harman International are registered trademarks, and Venue Series, EOS, PolyPlas and Pro Sound Comes Home are trademarks, of Harman International Industries, Incorporated.

Dolby is a registered trademark of Dolby Laboratories.

DTS is a registered trademark of DTS, Inc.

	PRO SOUND COMES HOME™
JBL, Incorporated, 250 Crossways Park Drive, Woodbury, NY 11797 USA 8500 Balboa Boulevard, Northridge, CA 91329 USA 2, route de Tours, 72500 Château du Loir, France 516.255.4JBL (4525) (USA only) www.jbl.com © 2006 Harman International Industries, Incorporated. All rights reserved. Part No. 406-000-05330-E	
H A Harman International® Company	