

**SAMSUNG**

**OWNER'S INSTRUCTIONS  
MANUAL DE INSTRUCCIONES  
MANUEL D'UTILISATION  
MANUAL DE INSTRUÇÕES  
ISTRUZIONI PER L'USO**

AW07F2SBA/DA/EA

AW09F2SBA/BB/DA/EA

AW10F2JBA/DA/EA

AW12F2JBA/DA/EA

AW14F2MBA/DA/EA

AW18F2MBA/DA/EA/BC

AWT18F2MDA

AW22F2MBA

AW22F2MBB

AW24F2MBA

AW24F2MBB

AW07A(G)2SBA/DA/EA

AW09A(G)2SBA/BB/DA/EA

AW10A(G)2JBA/DA/EA

AW12A(G)2JBA/DA/EA

AW14A(G)2MBA/DA/EA

AW18A(G)2MBA/DA/EA/BC

AWT18A(G)2MDA

AW22A(G)2MBA

AW22A(G)2MBB

AW24A(G)2MBA

AW24A(G)2MBB

**Window-type Room Air Conditioner ( Cool )  
Acondicionador de aire doméstico sistema de tipo ventana ( Refrigeración )  
Climatiseur de type Fenêtre ( Refroidissement )  
O ar Condicionado de Window-Type ( Refrigeração )  
Condizionatore d'aria per ambienti da finestra ( Raffreddamento )**

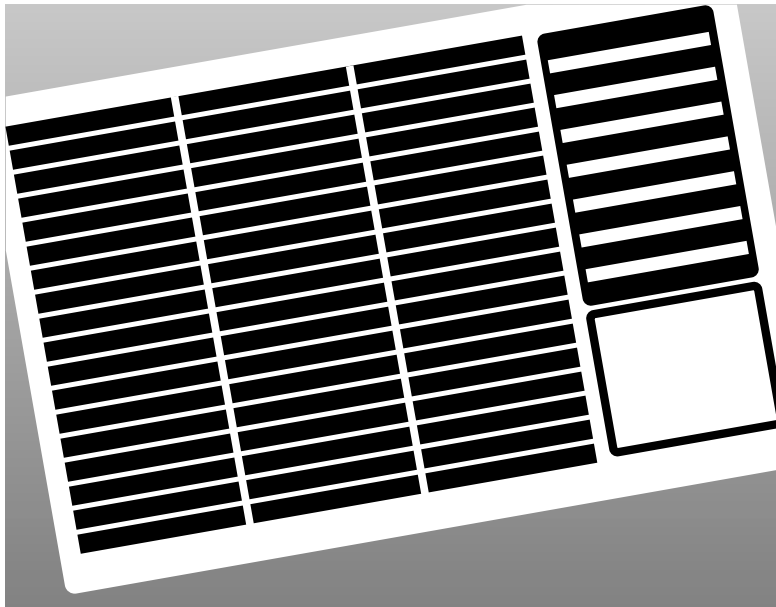

## Safety Precautions

**The following safety precautions must be taken when installing and using your air conditioner.**

---

**1** *The air conditioner must be plugged into its own specific power source, which must be installed in compliance with national wiring, earthing and safety regulations.*

*Depending on national regulations and your specific installation, you may need to install:*

- ◆ *A circuit breaker*

*For further information on electrical requirements, contact a professional electrician.*

*This device must be installed according to the national electrical rules.*

---

**2** *Make sure that the unit is correctly ventilated at all times; do NOT place clothing or other materials over it.*

---

**3** *NEVER spill liquid of any kind into the unit. Should this happen, unplug the unit and contact your installation specialist.*

---

**4** *Do NOT insert anything between the air outlet blades, as the inner fan may be damaged and you may be hurt. Keep children away from the unit.*

---

**5** *ALWAYS ensure that the power cable is in good condition. Make sure that it is not walked on or damaged by items placed on or against it.*

*If the power cord is damaged in any way, it must be replaced by the manufacturer or its service agent or a similarly qualified person in order to avoid a hazard.*

---

**6** *Do NOT attempt to repair the unit yourself. If it is damaged in any way, contact:*

- ◆ *An approved service center*
- ◆ *The outlet at which the air conditioner was purchased*

---

**7** *Do NOT place any obstacles in front of the unit.*

---

**8** *The appliance is not intended for use by young children or infirm person without supervision; young children should be supervised to ensure that they do not play with the appliance.*

---

### **CAUTION**

**The manufacturer do not take the responsibility of the accident happened because the air conditioner is not fixed firmly or installed securely, during installing or using the product. In case you have difficulty in installation, you must ask for an installation specialist help. The accident will be happened in case of installing improperly.**

# Contents

---

- ◆ PREPARING YOUR AIR CONDITIONER
  - Safety Precautions ..... 2
  - Air Conditioning Unit - Main Parts and Control Panel ..... 4
  - Getting Started ..... 5
- ◆ OPERATING YOUR AIR CONDITIONER
  - Cooling Your Room ..... 6
  - Setting the Off timer ..... 7
  - Cancelling the Off Timer ..... 7
  - Switching the Air Conditioner Off ..... 7
  - Adjusting the Air Flow Direction Horizontally ..... 8
  - Adjusting the Air Flow Direction Vertically ..... 8
  - Using the Ventilation Lever ..... 8
- ◆ RECOMMENDATIONS FOR USE
  - Operating Recommendation ..... 9
  - Temperature and Humidity Ranges ..... 9
  - Cleaning Your Air Conditioner ..... 10
  - Solving Common Problems ..... 12
  - Technical Specifications ..... 13
- ◆ INSTALLATION ..... 14

**CAUTION**

" The high inrush current of the starting compressor motor can have adverse effects to the operation of other equipment under unfavorable mains conditions. This equipment does not comply with the relevant technical standards for the limitation of voltage fluctuations and flicker."

Before connecting this equipment to the power supply system, please report to your supply authority and obtain the consent.

Do not connect other electric appliances to the same supply lines.

**AW18\*\***

The maximum permissible system impedance at the power junction box is 0.24 ohms. Usually, the maximum permissible mains impedance will not be exceeded when the branch to the power outlet is fed from a junction box with a rated current of 32A.

# Air Conditioning Unit - Main Parts and Control Panel

\* The design and shape are subject to change according to the model.

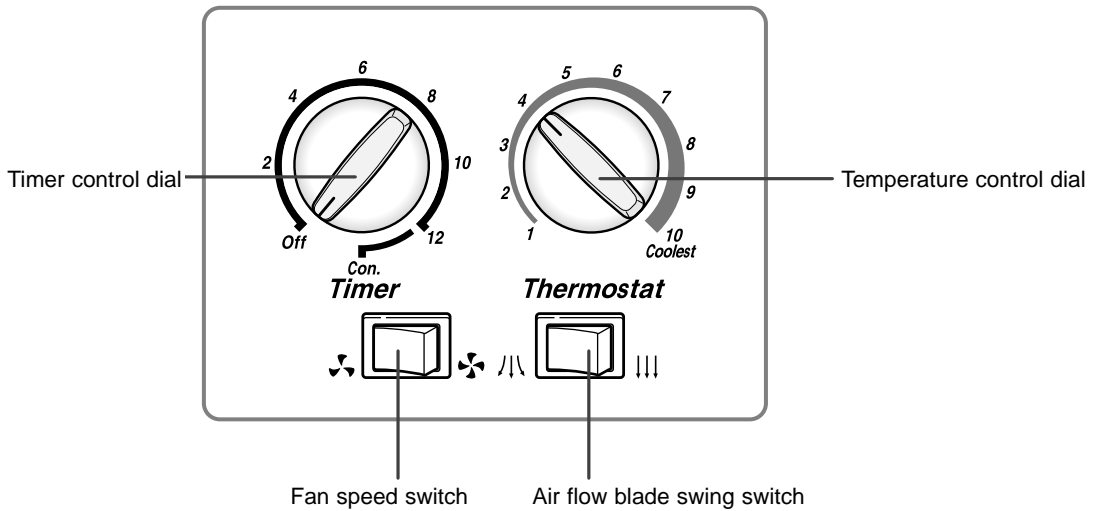
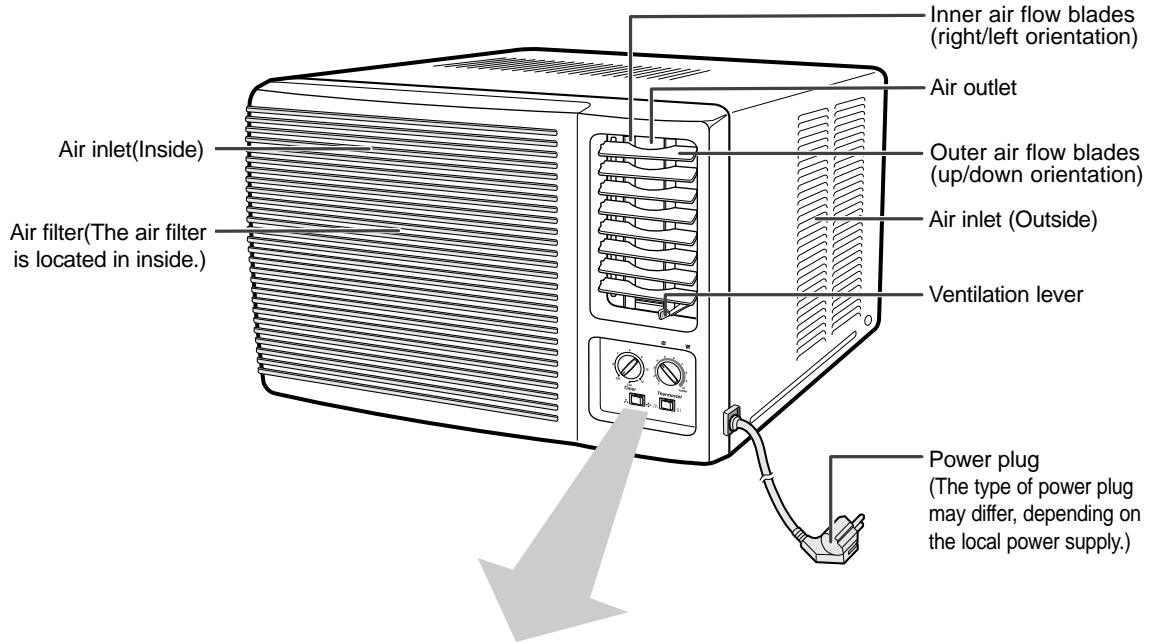

## Getting Started

*You have just purchased a window-type room air conditioner and it has been installed by your installation specialist.*

*Your Owner's Instructions contain much valuable information on using your air conditioner. Please take the time to read them as they will help you take full advantage of the unit's features.*

*This Owner's Instructions is just for using your air conditioner correctly. Thus, the illustrations shown in this manual may not exactly match your air conditioner.*

*The booklet is organized as follows.*

- ◆ *The illustration on page 4 shows the air conditioning unit; it indicates the location and purpose of the main parts and controls on the unit.*
- ◆ *In the main part of the document, you will find a series of step-by-step procedures for each function available.*

*The illustrations in the step-by-step procedures use four different symbols:*

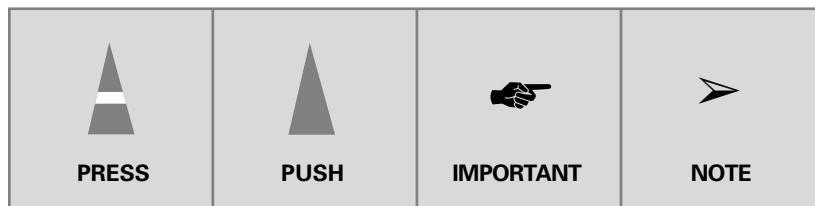

## Cooling Your Room

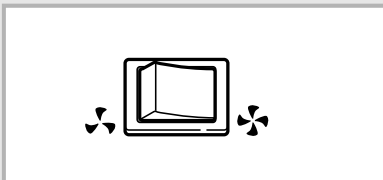
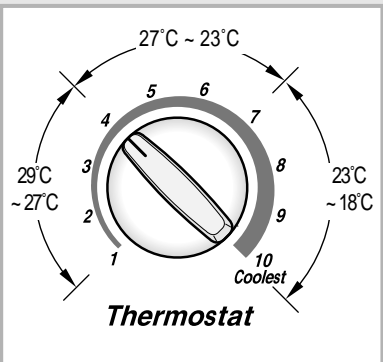
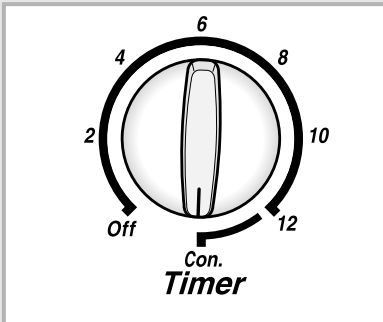

**You must select the Cool mode if you wish to lower the temperature in your room. You can also set the fan speed.**

- 1 Set the timer control dial to the "CON." position.

**Result:** The air conditioner starts up in Cool mode.



- When attempting to use it for a specified period of time, set it to the desired period of time. Refer to page 7.

- 2 To adjust the temperature, turn the temperature control dial to the desired position.

Possible temperatures: Between 18°C and 29°C inclusive.

**Result:** The air conditioner starts cooling if the room temperature is higher than the selected temperature.

- 3 If necessary, set the FAN SPEED switch to the desired speed.

-  The fan turns rapidly.
-  The fan turns slowly.

- 4 To control the direction of the air flow, refer to page 8.

## Setting the Off Timer

**Use the timer when attempting to operate the air conditioner for a specified period of time, and then turn it off automatically.**

- 1 Set the timer control dial to the desired time.

**Example:** ♦ When you want to turn it off after operating it for four hours, set it to "4".

➤ Some minor errors may occur when setting the time depending upon the supply power and position of the timer.

- 2 Set it to desired operating conditions.  
Refer to page 6.

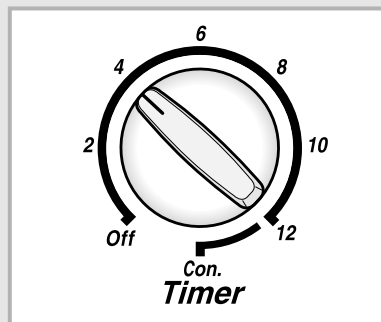

## Cancelling the Off Timer

**You can cancel the operation of the timer whenever you want to cancel it.**

- 1 Set the timer control dial to the "CON." or "OFF" position.

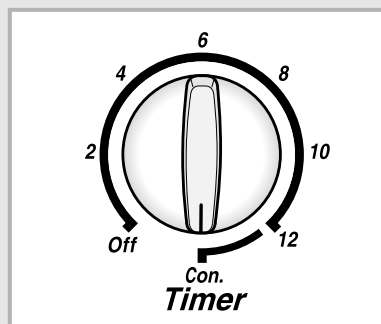

## Switching the Air Conditioner Off

**You can switch the air conditioner off whenever you want.**

To switch the unit off, simply set the timer control dial to the "OFF" position.

**Result:** The air conditioner stops operating.

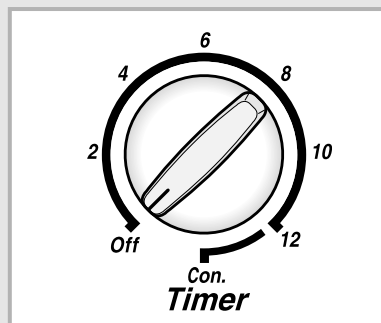

## Adjusting the Air Flow Direction Horizontally

*Depending on the position of the unit in your room, you can adjust the orientation of the inner air flow blades on the right-hand side of the unit, thus increasing the efficiency of the air conditioner.*

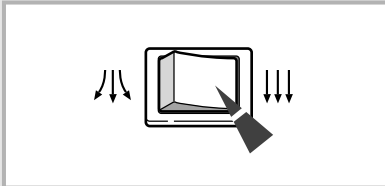
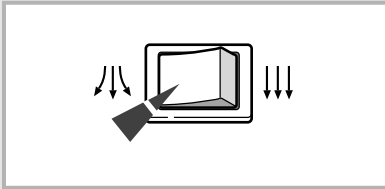

- 1 Set the air flow blade swing switch to the ← position.

**Result:** The inner blades swing automatically left and right.

- 2 To stop the blades moving left and right, set the air flow blade swing switch to the ↓ position.

- To stop the blades in a specific position and orient the air flow in the corresponding direction, simply set the switch to the ↓ position when the blades are in the desired position.

## Adjusting the Air Flow Direction Vertically

*Again depending on the position of the unit in your room, you can adjust the orientation of the outer air flow blades on the right-hand side of the unit.*

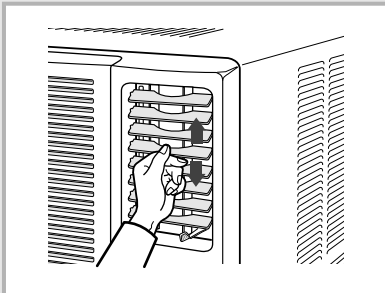

RECOMMENDATION	When...	Adjust the blades to face...
	Cooling	Upwards.

Adjust the air flow blades to the desired position, by pushing them upwards or downwards.

- If you orient the air flow blades downwards and the unit operates in Cool mode for long periods of time, dew may:
  - ◆ Form on the surface of the blades
  - ◆ Drip from the blades

## Using the Ventilation Lever

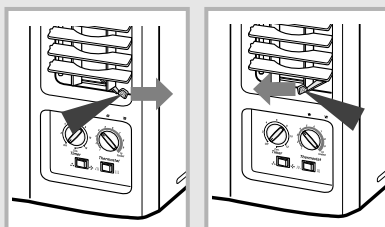

*Use the ventilation lever when you want to exhaust unrefresh air.*

- 1 If you wish to evacuate stale air outside, push the ventilation lever on the front of the unit to the right and the open position (→).

**Result:** The air inside the room circulates and stale air is evacuated outside.

Otherwise, push the ventilation lever to the left and the closed position (←).

**Result:** The air simply circulates inside the room.



## Operating Recommendation

*Here is a recommendation that you should follow when using your air conditioner.*

Topic	Recommendation
Power failure	If a power failure occurs when the air conditioner is operating, the unit is switched off. When the power returns, the air conditioner starts up again automatically.

## Temperature and Humidity Ranges

*The following table indicates the temperature and humidity ranges within which the air conditioner can be used.*

Mode	Indoor Temperature	Outdoor Temperature	Indoor Humidity
Cooling	21°C to 32°C approx.	21°C to 43°C approx.	80% or less

If the air conditioner is used at...	Then...
Higher temperature	The automatic protection feature may be triggered and the air conditioner stopped.
Lower temperature	A water leakage or some other malfunction may happen if the heat exchanger freezes.
Higher humidity levels	Water may condense on and drip from the surface of the unit if it is used for long periods.

# Cleaning Your Air Conditioner (\*\*\*\*F2\*\*\*\* models)

**Be sure to clean the air filter periodically to maintain the air conditioner in the best condition for a long period of time.**

**IMPORTANT** When cleaning the air conditioner, turn it off and pull out the power plug.

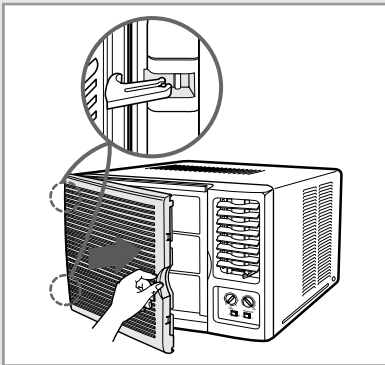
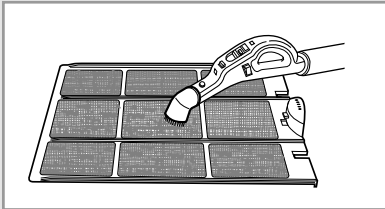
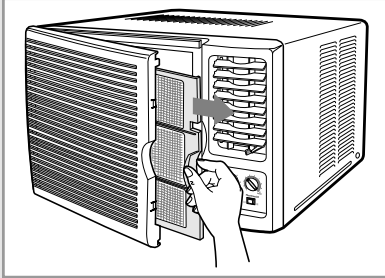

The air conditioner has two or three grille grooves depending on the model.

- 1 Hold the air filter handle, slightly pull it to the left side and open the front grille.

➤ The removal of the front grille makes it easier to clean the air conditioner. Open the grille as much as possible.

## CAUTION

### Removal and Reassembly of the Front Grille

*For user's safety, a safety clip has been installed in the front grille.*

- 1 Grasp the lower part of the front grille and the air filter handle, then open the grille.
- 2 Remove the safety clip and the front grille.
- 3 When reassembling the front grille, you should install the safety clip again.

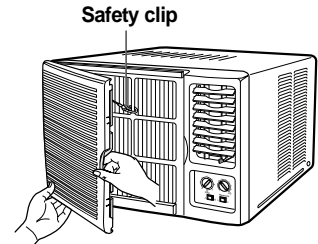

- 2 Pull the air filter to the right side.

- 3 Remove all dust on the air filter with a vacuum cleaner or brush.

- 4 When you have finished, insert the air filter back into its original position.

- 5 Wipe the surface of the unit with a neutral detergent and then wipe it again with dry cloth.

(Be sure not to use benzene, solvent or other chemical products.)



#### If you...

Will not be using the air conditioner for a long period of time

Have not used the air conditioner for a long period of time

#### Then...

- ◆ Set the timer control dial to "CON.", the temperature control dial to "2" or less, and let it run of a few hours to dry the inside of the air conditioner thoroughly.
- ◆ Switch the air conditioner off and unplug it from the wall socket.
- ◆ Clean the filter and outer surfaces.

Set the timer control dial to "CON.", the temperature control dial to "2" or less, and let it run of a few hours to dry the inside of the air conditioner thoroughly.

## Cleaning Your Air Conditioner (\*\*\*\*A2/G2\*\*\*\* models)

**To get the best possible use out of your air conditioner, you must clean it regularly by two weeks to remove the dust on the air filter.**

 Before cleaning your air conditioner, ensure that it is switched off and unplugged from the wall socket.

- 1 Open the front grille by pulling on the tabs of the unit.
  - The removal of the front grille makes it easier to clean the air conditioner. After opening the front grille, lift it up as much as possible, then pull down to release it.
- 2 Grasp the handle on the air filter and lift it slightly and then out to the front.
- 3 Remove all dust on the air filter with a vacuum cleaner or brush.
- 4 When you have finished, slide the air filter back into position.
- 5 Clean the outer surfaces with a damp cloth and mild detergent (do NOT use benzene, solvents or other chemicals). Wipe them dry with a clean, soft cloth.

➤ If you...	Then...
Will not be using the air conditioner for a long period of time	<ul style="list-style-type: none"> <li>◆ Set the fan going for a few hours to dry the inside of the air conditioner thoroughly.</li> <li>◆ Switch the air conditioner off and unplug it from the wall socket.</li> <li>◆ Clean the filter and outer surfaces.</li> </ul>
Have not used the air conditioner for a long period of time	Set the fan going for a few hours to dry the inside of the air conditioner thoroughly.

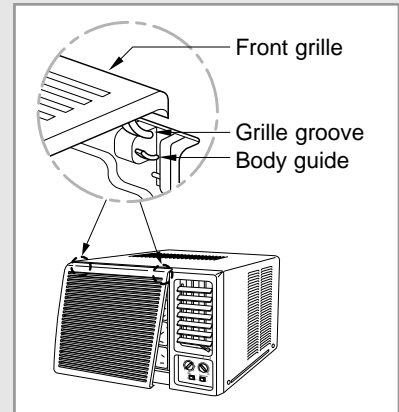
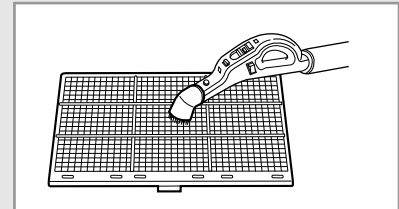
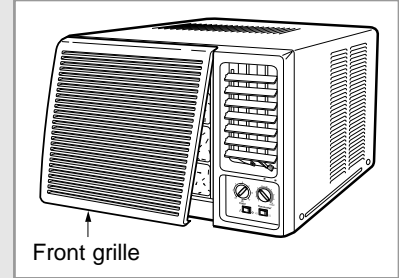

## Solving Common Problems

***Before contacting the after-sales service, perform the following simple checks. They may save you the time and expense of an unnecessary call.***

PROBLEM	EXPLANATION / SOLUTION
The air conditioner does not operate at all	<ul style="list-style-type: none"><li>◆ Check that the circuit breaker used for the air conditioner has not been triggered.</li><li>◆ Check that the power cable is plugged into a wall socket and the socket is switched on, if necessary.</li><li>◆ Check that the correct operating mode has been selected.</li></ul>
The air conditioner does not cool	<ul style="list-style-type: none"><li>◆ Set the temperature control dial to the desired position.</li><li>◆ The room temperature may be too low.</li><li>◆ Dust may be blocking the air filter; refer to page 10 or 11 for cleaning instructions.</li><li>◆ Check that there is no obstacle blocking the air flow into or out of the unit.</li></ul>
The air flow direction does not change when you set the air flow blade swing switch to the  position	<ul style="list-style-type: none"><li>◆ Check that the air conditioner has been switched on; if necessary, turn the timer control dial.</li></ul>
Odours are permeated in the room during air conditioning	<ul style="list-style-type: none"><li>◆ Air the room.</li></ul>

## Technical Specifications

*Design and specifications are subject to change without notice.*

Model	Power Supply
*****BA/BB/BC	220V~, 60Hz
*****DA	200-220V~, 50Hz
*****EA	220-240V~, 50Hz

# Installation

**Before installation, be sure to check the installation area or the air conditioner, and drain hose.**

## Checkpoints prior to installation

- 1 Check the cabinet and front grille of the unit for any harmful defects such as scratches.
- 2 Be sure to check the power supply.
  - Refer to the specifications on the label attached to the unit.

## Installation Conditions

- 1 As the unit is heavy, the wall or window of the installation area should have sufficient strength and durability for operation of the air conditioner, and for prevention of any vibration or noise. If it is weak, reinforcement work should be performed separately.
- 2 It is advisable to install the air conditioner in the north or west side to prevent the effect of direct sunlight. When installing it in the south or east side due to unavoidable circumstances, it is advisable to install the sunshade to prevent the direct sunlight. In this case, take care not to cause any hindrance to the flow of outside air.
- 3 When installing the air conditioner, be sure to obtain sufficient space on the rear side of the unit for smooth flow of air. When operating the air conditioner in closed areas such as inner building with cooling operation, and result in trouble with the unit. See the illustration below.

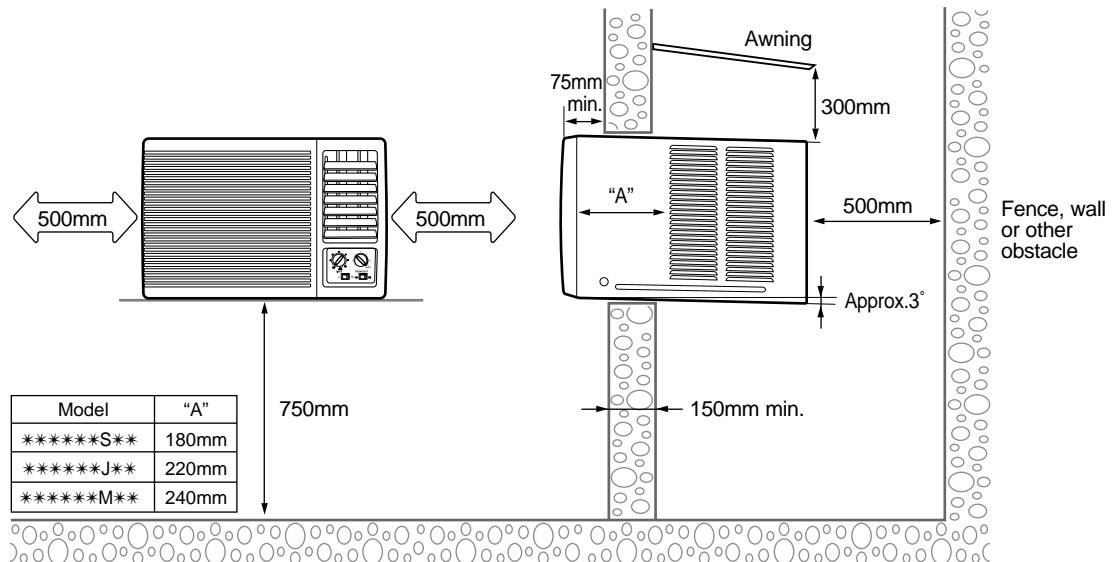

- ◆ If the wall is greater than 150mm thick, cut the wall back on a 45° angle if possible.

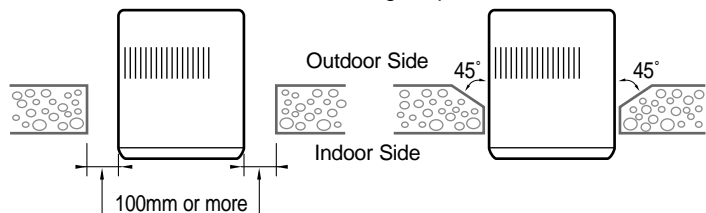

**In some region, drain tube and drain pan may not be supplied.  
Please contact the sales agent.**

### Installation of the Drain Tube

Fix the drain tube as shown in the figure.

**Le tube du drain et l'égouttoir peuvent ne pas être inclus selon le lieu de vente.  
Contacter votre vendeur agréé pour plus d'informations.**

### Installation of the Drain Pan

The procedure for installing the drain pan should be determined by the condition of the installing area.

◆ **In the case of an area where the drain pan can not be directly installed on the rear side of the unit after installing the air conditioner.**

Example: High storage

1 Open the front grille ; refer to page 10 or 11.

2 **Remove the screw located at the lower section of the front grille.  
It is secured in the  section depending on the model.**

3 Remove the front panel.

3-1 Press both sides of the cabinet in the direction of the arrow as shown in the figure.

3-2 Pull the lower part of the front panel slightly forward.  
(below three inches)

3-3 Lift the front panel upward.



Applying excessive force to remove the front panel may cause damage to the tab ; be sure not to use excessive force.

4 Remove two screws on the lower, right and left sides of the unit.

5 Remove the chassis from the cabinet.

6 Remove the rubber cap inserted into the basepan.

7 Fix the drain pan as shown in the figure, and then connect the drain hose.  
(You can use any commercially-available drain hose.)

8 Install the cabinet at the specified area after installing the drain pan, and then re-assemble it in the original condition.

➤ Secure the front panel to the case by replacing the screw removed in step 2. If a screw not removed in step 2, secure the panel with a supplied screw.

◆ **In the case of an area where the drain pan can be directly installed on the rear side of the unit after installing the air conditioner.**

1 Follow steps 6 and 7 only

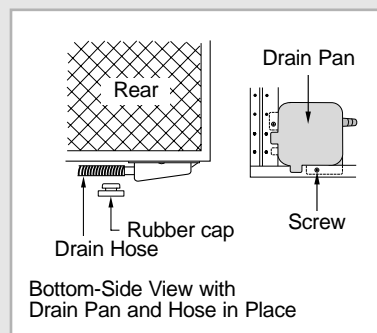
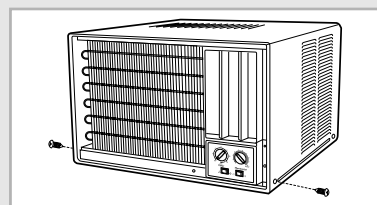
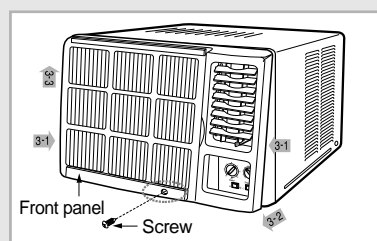
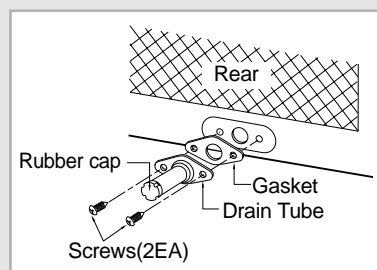

**THIS AIR CONDITIONER IS MANUFACTURED BY:  
ESTE ACONDICIONADOR DE AIRE HA SIDO FABRICADO POR:  
CE CLIMATISEUR EST FABRIQUÉ PAR:  
ESTE APARELHO DE AR CONDICIONADO É FABRICADO POR:  
QUESTO CONDIZIONATORE D'ARIA È PRODOTTO DA:**



**ELECTRONICS**