



MT3600 (2.15 cu.in) - MT4000 (2.38 cu.in)

en OPERATOR'S INSTRUCTION MANUAL

fr MANUEL D'UTILISATION ET D'ENTRETIEN

es MANUAL DE INSTRUCCIONES



To correctly use the chain saw and prevent accidents, do not start work without having first carefully read this manual. You will find explanations concerning the operation of the various parts plus instructions for necessary checks and relative maintenance.

Note: Illustrations and specifications in this manual may vary according to Country requirements and are subject to change without notice by the manufacturer.

THE OPERATOR'S MANUAL

Your operator's manual is for your protection. READ IT. Keep it in a safe place for reference. Know what you are doing before you begin assembly of the unit. Proper preparation and upkeep go hand-in-hand with satisfactory performance of the saw and safety.

Contact your dealer or the distributor for your area if you do not understand any of the instructions in this manual.

In addition to the operating instructions, this manual contain paragraphs that require your special attention.

Such paragraphs are marked with the symbols described below:

Warning: where there is a risk of an accident or personal injury or serious damage to property.

Caution: where there is a risk of damaging the machine or its individual components.



WARNING - To ensure safe and correct operation of the chainsaw, this operator's manual should always be kept with or near the machine. Do not lend or rent your chainsaw without the operator's instruction manual.



WARNING: Allow only persons who understand this manual to operate your chainsaw.

PRODUCT IDENTIFICATION

Chain Saw Components 4

SAFETY

Understanding Safety Labels 5

State and Local Requirements 5

SAFETY RULES

Basic Safety Precautions 7

Fuel Handling 8

Operation and Safety 8

Precautions Against Kickback 9

Precautions to Reduce Vibration Risk 13

Maintenance Precautions 13

ASSEMBLY

Assembling the Bar and Chain 15

OPERATION

Chain Tension 17

Breaking-in the Chain 17

Bucking Spike 18

Fueling 18

Chain Oil System 19

Preparation for Cutting 19

Starting the Engine 21

Breaking-in the Engine 22

Stopping the Engine 23

Chain Brake Operation 23

Tree Felling 24

Bucking 25

Limbing and Pruning 27

MAINTENANCE

Maintenance Chart 29

Chain Maintenance 30

Guide Bar Maintenance 31

Carburetor Adjustment 31

Fuel Filter 32

Air Filter 32

Starter Unit 32

Engine 33

Spark Plug 33

Spark Arresting Muffler 33

Chain Brake 34

TROUBLESHOOTING

Using Troubleshooting Chart 35

STORAGE

Storing Chain Saw 36

TECHNICAL DATA

MT 3600 36

MT 4000 36

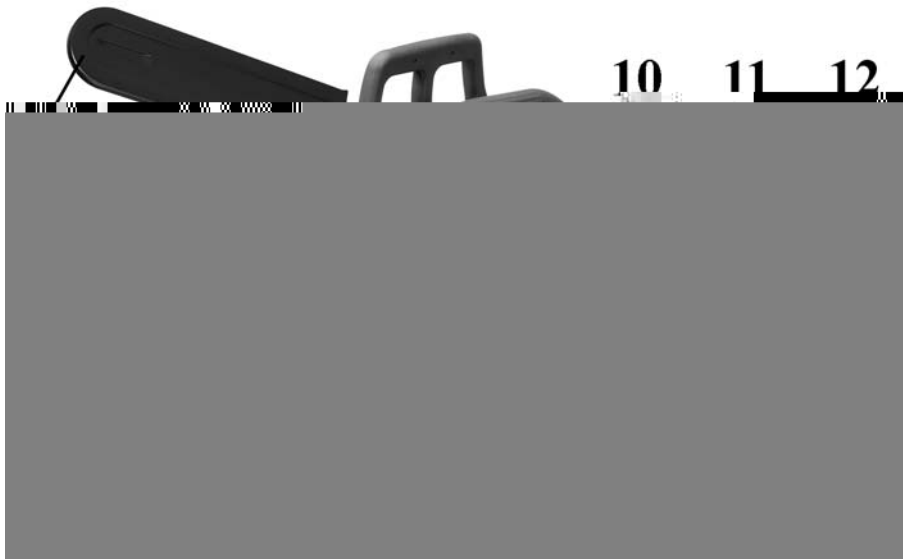

Chain Saw Components

- | | |
|------------------------------------|-------------------------|
| 1 - Throttle Trigger Lockout | 10 - On/Off Switch |
| 2 - Air Filter Cover | 11 - Choke Lever |
| 3 - Front Handle | 12 - Throttle Trigger |
| 4 - Chain Brake Lever / Hand Guard | 13 - Rear Handle |
| 5 - Muffler | 14 - Fuel Tank Cap |
| 6 - Chain | 15 - Starter Handle |
| 7 - Guide Bar | 16 - Oil Tank Cap |
| 8 - Guide Bar Adjusting Screw | 17 - Combination Wrench |
| 9 - Carburetor Adjustment Screws | 18 - Bar Cover |

Understanding Safety Labels



- This symbol indicates Warning, and Caution.



- Your manual contains special messages to bring attention to potential safety concerns, machine damage as well as helpful operating and servicing information. **PLEASE READ ALL THE INFORMATION CAREFULLY TO AVOID INJURY AND MACHINE DAMAGE.**



- Wear eye, hearing and head protection when operating this equipment.



- Wear non-slip, heavy-duty protective gloves when handling the chain saw and saw chain.



- Wear safety strong shoes or boots having skid-proof sole and anti-piercing insert.



- **WARNING!** Beware of Kickback. Avoid bar nose contact.



- Always hold saw properly with both hands.



- Measured maximum kickback value without chain brake for the bar and chain combination on the label.

State and Local Requirements

Your saw is equipped with a temperature limiting muffler and a spark arresting screen in order to comply with the requirements of SAE Recommended Practice J335 and California Codes 4442 and 4443. **All national forest land and land managed by the states of California, Maine, Washington, Idaho, Minnesota, New Jersey and Oregon require internal combustion engines to be equipped with a spark arrester screen by law. Other states and federal agencies are enacting similar regulations.**

If you operate a chain saw in a state or locale where such regulations exist, you are legally responsible for maintaining the operating condition of these parts. Failure to do so is a violation of a law. **Spark arrester maintenance is described in the Maintenance-Spark Arresting Muffler Section of the manual.**

Note: When using a chainsaw for logging purposes, refer to Code of Federal Regulations, Parts 1910 and 1928.



WARNING: The ignition system of your unit produces an electromagnetic field of a very low intensity. This field may interfere with some pacemakers. To reduce the risk of serious or fatal injury, persons with pacemaker should consult their physician and the pacemaker manufacturer before operating this tool.



WARNING: Muffler surfaces are very hot during and after operation of the chain saw, keep all body parts away from the muffler. Serious burns may occur if contact is made with the muffler.



WARNING: Exposure to vibrations through prolonged use of gasoline powered hand tools could cause blood vessel or nerve damage in the fingers, hands, and wrists of people prone to circulation disorders or abnormal swellings. Prolonged use in cold weather has been linked to blood vessel damage in otherwise healthy people. If symptoms occur such as numbness, pain, loss of strength, change in skin color or texture, or loss of feeling in the fingers, hands, or wrists, discontinue the use of this tool and seek medical attention.



WARNING: The engine exhaust from this product contains chemicals known to the State of California to cause cancer, birth defects or other reproductive harm. Operate your chainsaw outdoors only in a well ventilated area.



Basic Safety Precautions

- Read this manual carefully until you completely understand and can follow all safety rules, precautions, and operating instructions before attempting to use the unit.
- Restrict the use of your saw to adult users who understand and can follow safety rules, precautions, and operating instructions found in this manual. Minors should never be allowed to use a chainsaw.
- Do not handle or operate a chain saw when you are fatigued, ill, or upset, or if you have taken alcohol, drugs, or medication. You must be in good physical condition and mentally alert. Chain saw work is strenuous. If you have any condition that might be aggravated by strenuous work, check with your doctor before operating a chain saw (Fig. 1). Be more cautious before rest periods and towards the end of your shift.
- Keep children, bystanders, and animals a minimum of 35 feet (10 meters) away from the work area. Do not allow other people or animals to be near the chain saw when starting or operating the chain saw (Fig. 2).
- Major cases of chainsaw accidents happen when the chain hits the operator. While working with the chainsaw, always use safety protective approved clothing. The use of protective clothing does not eliminate injury risks, but reduces the injury effects in case of accident. Consult your trusted supplier to choose equipment in compliance with legislation. The clothing must be proper and not an obstacle. Wear adherent anti-cut clothing. **Anti-cut jackets (Fig.3), dungarees (Fig.3) and leggings are ideal.** Do not wear clothes, scarves, ties or bracelets that may get stuck in wood or twigs. Tie up and protect long hair (example with foulards, cap, helmets, etc.). **Safety shoes or boots having skid-proof sole and anti-piercing insert (Fig.4). Wear protective helmet (Fig.5) in places where there can be falling objects. Wear protective goggles or face screens! Use protections against noises: for example noise reduction ear guards (Fig.5) or earplugs.** The use of protections for the ear requests much more attention and caution, because the perception of danger audio signals (screaming, alarms, etc.) is limited. **Wear anti-cut gloves (Fig.6, page 8).**
- Only loan your saw to expert users who are completely familiar with saw operation and correct use. Give other users the manual with operating instructions, which they have to read before using the saw.
- Check the chain saw each day to ensure that each device, whether for safety or otherwise, is functional.
- Never use a damaged, modified, or improperly repaired or assembled chain saw. Do not remove, damage or deactivate any of the safety devices. Only use bars of the length indicated in the table (page 13). Always replace bar, chain, hand guard, or chain brake immediately if it becomes damaged, broken or is otherwise removed.
- Carefully plan your sawing operation in advance. Do not start cutting until you have a clear work area, secure footing, and, if you are felling trees, a planned retreat path.
- All saw service, other than the operations shown in the present manual, have to be performed by competent personnel.
- The chain saw must only be used for cutting wood. It is unadvisable to cut other types of material.
- It is unadvisable to hitch tools or applications to the P.t.o. that are not specified by the manufacturer.



6



7

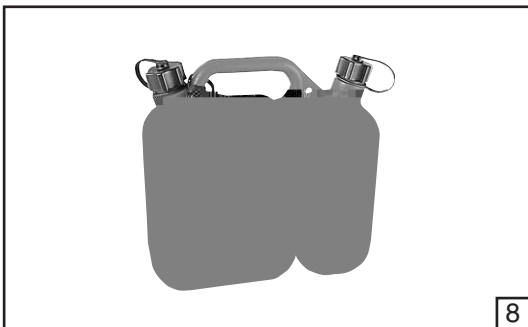

8

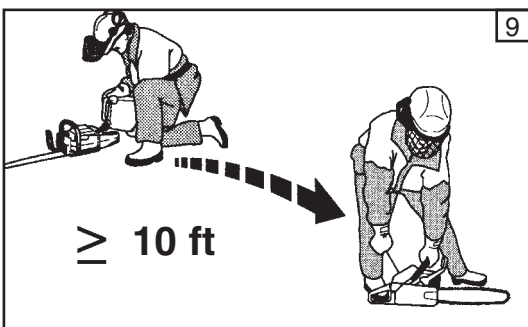

9

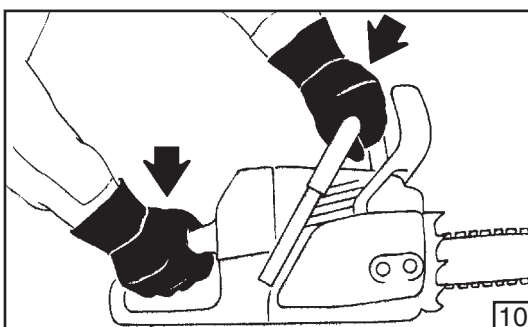

10

Fuel Handling



WARNING: Gasoline is an extremely flammable fuel. Use extreme caution when handling gasoline or fuel mix. Do not smoke or bring any fire or flame near the fuel or the chainsaw (Fig. 7).

- To reduce the risk of fire and burn injury, handle fuel with care. It is highly flammable.
- Mix and store fuel in a container approved for gasoline (Fig. 8).
- Mix fuel outdoors where there are no sparks or flames.
- Select bare ground, stop engine, and allow to cool before refueling.
- Loosen fuel cap slowly to release pressure and to keep fuel from escaping around the cap.
- Tighten fuel cap securely after refueling. Unit vibration can cause an improperly tightened fuel cap to loosen or come off and spill quantities of fuel.
- Wipe spilled fuel from the unit. Move 10 feet (3 m) away from refueling site before starting engine (Fig. 9).
- Never attempt to burn off spilled fuel under any circumstances.
- Do not smoke while handling fuel or while operating the saw.
- Store fuel in a cool, dry, well ventilated place.
- Never place the saw in a combustible area such as dry leaves, straw, paper, etc.
- Store the unit and fuel in an area where fuel vapors cannot reach sparks or open flames from water heaters, electric motors or switches, furnaces, etc.
- Never take the cap off the tank when the engine is running.
- Never use fuel for cleaning operations.
- Take care not to get fuel on your clothing.

Operation and Safety



WARNING: Always hold the chain saw with both hands when the engine is running. Use a firm grip with thumbs and fingers encircling the chain saw handles (Fig. 10).

- Keep all parts of your body away from the saw chain when the engine is running.
- Always carry the chain saw with the engine stopped and chain brake engaged, the guide bar and saw chain to the rear, and the muffler away from your body. When transporting your chain saw, use the appropriate guide bar scabbard (Fig. 11). When transporting in a vehicle, keep chain and bar covered with the chain guard. Properly secure your saw to prevent turnover, fuel spillage and damage to the saw.
- Apply chain brake prior to any repositioning of the operator in the cutting area.
- **Do not operate a chain saw with one hand!** Serious injury to the operator, helpers, bystanders, or any combination of these persons may result from one-handed operation. **A chain saw is intended for two-handed use.**
- Before you start the engine, make sure the saw chain is not contacting any object. Never try to start the saw when the guide bar is in a cut.
- Shut off the engine before setting down the saw. Do not leave the engine running unattended.

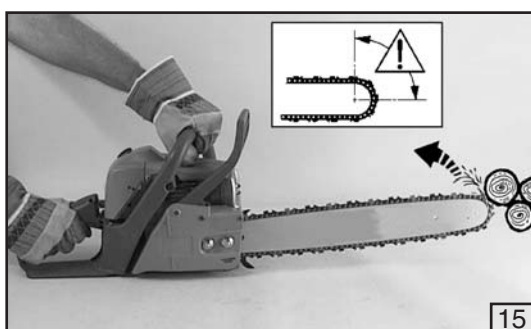
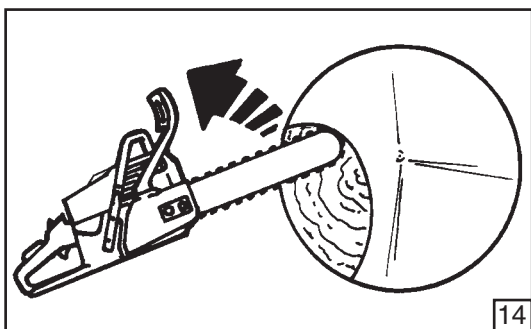
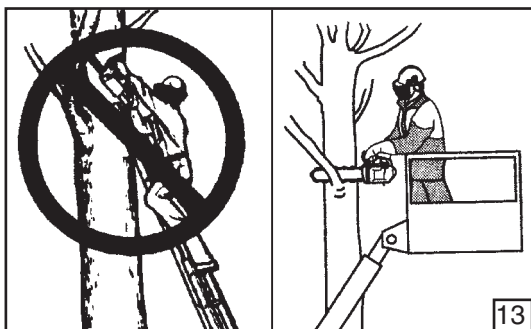
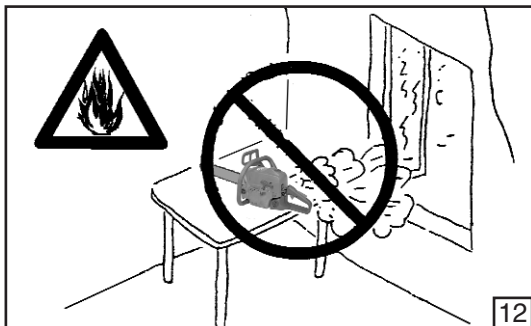
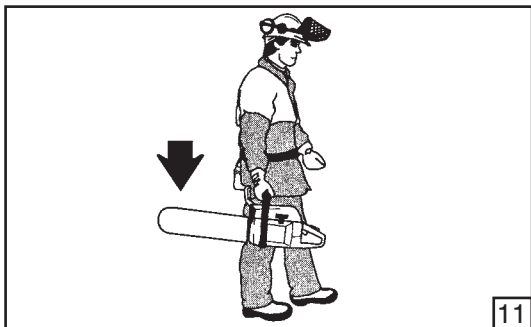

- As an additional safety precaution, apply the chain brake prior to setting down the saw.
- Only use the chain saw in well-ventilated places, do not operate the chain saw in explosive or flammable atmospheres or in closed environments (Fig. 12). Beware of carbon monoxide poisoning.
- Do not operate saw from a ladder or in a tree. Always cut from a firm-footed and safe position.
- Do not put pressure on the saw at the end of the cut. Applying pressure can cause you to lose control when the cut is completed.
- Do not cut near electric cables.
- Keep the handles dry, clean, and free of oil or fuel mixture.
- When the chain saw is running, grip the front handle firmly with your left hand and the back handle with your right hand (Fig. 10).
- When cutting a limb that is under tension, be alert for spring-back so you will not be struck when the tension in the wood fibre is released.
- Take great care when cutting small branches or shrubs which can block the chain, be thrown back towards you or cause you to lose your balance.
- Never cut with the chain saw above shoulder height (Fig. 13).
- Never start up the chain saw without the chain cover fitted.

Precautions Against Kickback



WARNING: Avoid kickback which can result in serious injury. Kickback is the backward, upward or sudden forward motion of the guide bar occurring when the saw chain near the upper tip of the guide bar contacts any object such as a log or branch, or when the wood closes in and pinches the saw chain in the cut. Contacting a foreign object in the wood can also result in loss of chain saw control.

- **Rotational Kickback** can occur when the moving chain contacts an object at the upper tip of the guide bar. This contact can cause the chain to dig into the object, which stops the chain for an instant. The result is an extremely fast, reverse reaction which kicks the guide bar up and back toward the operator (Fig. 14-15 and Fig. 16 page 10).
- **Pinch-Kickback** can occur when the wood closes in and pinches the moving saw chain in the cut along the top of the guide bar and the saw chain is suddenly stopped. This sudden stopping of the chain results in a reversal of the chain force used to cut wood and causes the saw to move in the opposite direction of the chain rotation. The saw is driven straight back toward the operator.
- **Pull-In** can occur when the moving chain contacts a foreign object in the wood in the cut along the bottom of the guide bar and the saw chain is suddenly stopped. This sudden stopping pulls the saw forward and away from the operator and could easily cause the operator to lose control of the saw.

Avoid Pinch-Kickback:

- Be extremely aware of situations or obstructions that can cause material to pinch the top of or otherwise stop the chain.
- Do not cut more than one log at a time.

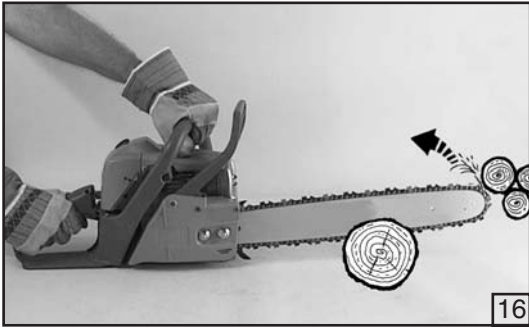

- Do not twist the saw as the bar is withdrawn from an undercut when bucking.

Avoid Pull-In:

- Always begin cutting with the engine at full speed and the saw housing against wood.
- Use wedges made of plastic or wood. Never use metal to hold the cut open.

Reduce the Risk of Kickback



Recognize that kickback can happen. With a basic understanding of kickback, you can reduce the element of surprise which contributes to accidents.

- Never let the moving chain contact any object at the tip of the guide bar.
- Keep the working area free from obstructions such as other trees, branches, rocks, fences, stumps, etc. Eliminate or avoid any obstruction that your saw chain could hit while you are cutting through a particular log or branch.
- Keep your saw chain sharp and properly tensioned. A loose or dull chain can increase the chance of kickback occurring. Follow manufacturer's chain sharpening and maintenance instructions. Check tension at regular intervals with the engine stopped, never with the engine running. Make sure the chain brake nuts are securely tightened after tensioning the chain.
- Begin and continue cutting at full speed. If the chain is moving at a slower speed, there is greater chance of kickback occurring.
- Cut one log at a time.
- Use extreme caution when re-entering a previous cut.
- Do not attempt cuts starting with the tip of the bar (plunge cuts).
- Watch for shifting logs or other forces that could close a cut and pinch or fall into chain.
- Use the Reduced-Kickback Guide Bar and Low-Kickback Chain specified for your saw.

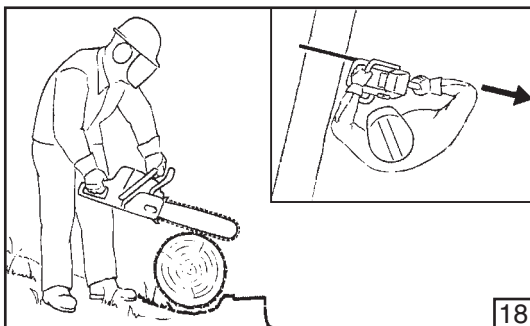
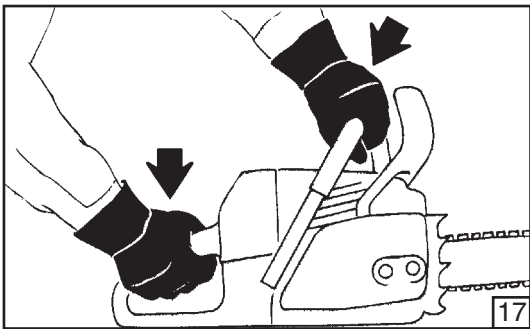

Maintain Control (Fig.17-18)

- Keep a good, firm grip on the saw with both hands when the engine is running and don't let go. A firm grip will help you reduce kickback and maintain control of the saw. Keep the fingers of your left hand encircling and your left thumb under the front handlebar. Keep your right hand completely around the rear handle whether you are right handed or left handed. Keep your left arm straight with the elbow locked.
- Position your left hand on the front handlebar so it is in a straight line with your right hand on the rear handle when making bucking cuts. Never reverse right and left hand positions for any type of cutting.
- Stand with your weight evenly balanced on both feet.
- Stand slightly to the left side of the saw to keep your body from being in a direct line with the cutting chain.
- Do not overreach. You could be drawn or thrown off balance and lose control of the saw.

- Do not cut above shoulder height. It is difficult to maintain control of saw above shoulder height.

Kickback Safety Features



WARNING: The following features are included on your saw to help reduce the hazard of kickback; however, such features will not totally eliminate this dangerous reaction. As a chain saw user, do not rely only on safety devices. You must follow all safety precautions, instructions, and maintenance in this manual to help avoid kickback and other forces which can result in serious injury.

- Reduced-Kickback Guide Bar, designed with a small radius tip which reduces the size of the kickback danger zone on the bar tip. A Reduced-Kickback Guide Bar has been demonstrated to significantly reduce the number and seriousness of kick-backs when tested in accordance with safety requirements for gasoline powered chain saws as set by ANSI B175.1 - 1991.
- Low-Kickback Chain, designed with a contoured depth gauge and guard link that deflect kickback force and allow wood to gradually ride into the cutter. Low-Kickback Chain has met kickback performance requirements when tested on a representative sample of chain saws below 3.8 cubic inch displacement specified in ANSI B175.1 - 1991.
- Front Hand Guard, designed to reduce the chance of your hand contacting the chain as your hand slips off the front handlebar.
- Position of front and rear handlebars, designed with distance between handles and “in-line” with each other. The spread and “in-line” position of the hands provided by this design work together to give balance and resistance in controlling the pivot of the saw back toward the operator if kick-back occurs.

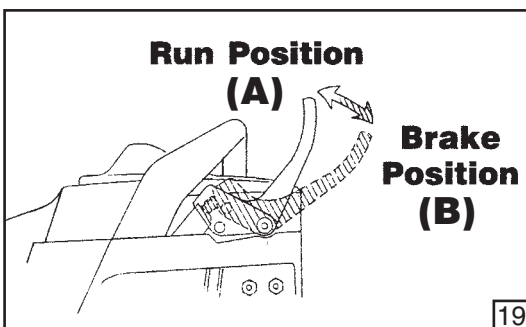

Chain Brake

Chain brakes are designed to rapidly stop the chain from rotating. When the chain brake lever / hand guard is pushed toward the bar, the chain should stop immediately. **A chain brake does not prevent kickback.**

The chain brake **Run Position (A)** and **Brake Position (B)** are illustrated on Fig. 19.

Chain brake should be cleaned and tested daily. Clean the chain brake per the Maintenance-Chain Brake Section and test per the Operation-Chain Brake Operation Section.



WARNING: Even with proper maintenance, the correct operation at the chain brake under field conditions can not be certified.



WARNING: WE DO NOT REPRESENT AND YOU SHOULD NOT ASSUME THAT THE CHAIN BRAKE WILL PROTECT YOU IN THE EVENT OF A KICKBACK. DO NOT RELY UPON ANY OF THE DEVICES BUILT INTO YOUR SAW. YOU SHOULD USE THE SAW PROPERLY AND CAREFULLY TO AVOID KICKBACK.

Reduced-Kickback Guide Bar and Low-Kickback Chain

Reduced-kickback guide bars and low-kickback saw chains reduce the chance and magnitude of kickback and are recommended. Your saw has a low kickback chain and bar as original equipment. Repairs on a chain brake should be made by an authorized servicing dealer. Take your unit to the place of purchase if purchased from a servicing dealer, or to the nearest authorized service dealer.



WARNING: Computed kickback angle (CKA) listed on your saw and listed in the CKA table below represents angle of kickback your bar and chain combinations will have when tested in accordance with CSA (Canadian Standards Association) and ANSI standards. When purchasing replacement bar and chain, considerations should be given to the lower CKA values. Lower CKA values represent safer angles to the user, higher values indicate more angle and higher kick energies. Computed angles represented indicate total energy and angle associated without activation of the chain brake during kickback. Activated angle represents chain stopping time relative to activation angle of chain break and resulting kick angle of saw. In all cases lower CKA values represent a safer operating environment for the user. The following guide bar and chain combinations meet kickback requirements of CSA Standards Z62.1, Z62.3, & ANSI B175.1 when used on saws listed in this manual. Use of bar and chain combinations other than those listed is not recommended and may not meet the CKA requirements per standard.



WARNING: Do not mount a bow guide on any EfcO chainsaw. The risk of kickback is increased with a bow guide because of the increased kickback contact area.

Recommended bar and chain combination

.325" x .058" Pitch Chain

MODEL	LENGTH OF BAR	GUIDE BAR P. N.	CHAIN TYPE	CHAIN P. N.	CKA WITHOUT CHAIN BRAKE
MT3600	14"	140SDEA041	91 P - 52 E	1255R	15°
MT3600	16"	160SDEA041	91 P - 57 E	1256R	15°
MT4000	14"	140SDEA041	91 P - 52 E	1255R	15°
MT4000	16"	160SDEA041	91 P - 57 E	1256R	15°



WARNING: The computer derived angles of par. 5.11 of ANSI B 175.1 – 1991 may bear no relationship to actual kickback bar rotation angles that may occur in real life cutting situations.

In addition, features designed to reduce kickback injuries may lose some of their effectiveness when they are no longer in their original condition, especially if they have been improperly maintained.

Compliance with par. 5.11 of ANSI B 175.1 – 1991 does not automatically mean that in a real life kickback the bar and chain will rotate at most 45°.

Precautions to Reduce Vibration Risk

- The chain saw is provided with anti-vibration (AV) system; never alter or modify it.
- Wear gloves and keep your hands warm.
- Keep the saw chain sharp and the saw, including the AV system, well maintained. A dull chain will increase cutting time, and pressing a dull chain through wood will increase the vibrations transmitted to your hands.
- Maintain a firm grip at all times, but do not squeeze the handles with constant, excessive pressures, take frequent breaks. All the above mentioned precautions do not guarantee that you will not sustain white-finger disease or carpal tunnel syndrome. Therefore, continual and regular users should monitor closely the condition of their hands and fingers. If any of the above symptoms appear, seek medical advice immediately.

Maintenance Precaution



WARNING: Never operate a chain saw that is damaged, improperly adjusted, or is not completely and securely assembled.

- Be sure that the saw chain stops moving when the throttle control trigger is released. If the saw chain moves at idle speed, the carburetor may need adjusting, see Operation-Carburetor Adjusting Section. If the saw chain still moves at idle speed after adjustment has been made, contact a Servicing Dealer for adjustment and discontinue use until the repair is made.



WARNING: All chain saw service, other than items in the Operator's Manual maintenance instructions, have to be performed by competent chain saw service personnel. (If improper tools are used to remove the flywheel or clutch, or if an improper tool is used to hold the flywheel in order to remove the clutch, structural damage to the flywheel could occur which could subsequently cause the flywheel to burst and serious injury could result.)

- Never modify your saw in any way.
- Keep the handles dry, clean, and free of oil or fuel mixture.



WARNING: Use only accessories and replacement parts recommended.

- Never touch the chain or attempt to service the saw while the engine is running.
- Never use fuel for cleaning operations.
- Keep the chain saw in a dry place, off the ground with the chain guard on and the tanks empty.
- If your chain saw is no longer usable, dispose of it properly without damaging the environment by handing it in to your local Dealer who will arrange for its correct disposal.
- Replace immediately any safety device when damaged or broken.



WARNING: The muffler and other parts of the engine (e.g. fins of the cylinder, spark plug) become hot during operation and remain hot for a while after stopping the engine. To reduce risk of burns do not touch the muffler and other parts while they are hot.

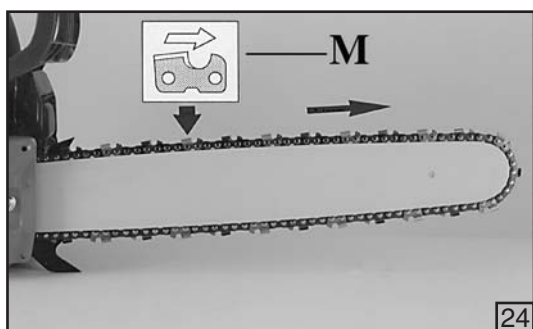
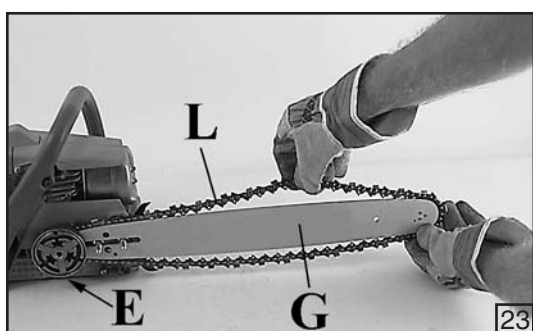
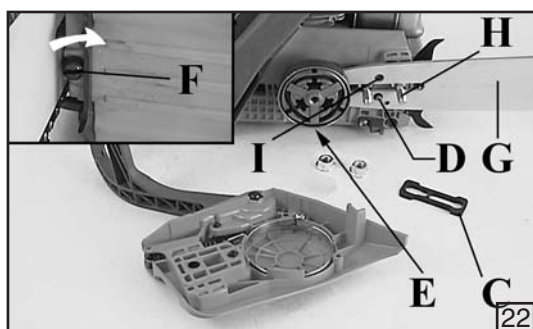
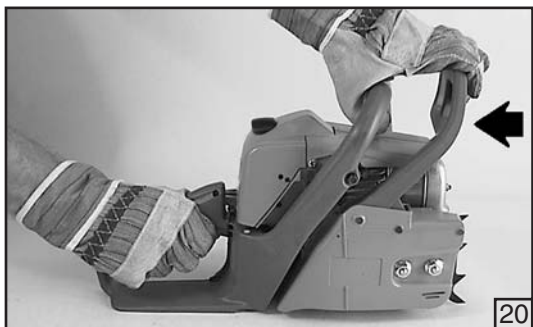

Assembling the Bar and Chain



WARNING: Check the chain tension frequently when operating the chain saw. Never touch or adjust the chain while the engine is running. The saw chain is very sharp, always wear protective gloves when performing maintenance to the chain.

1. Ensure that the chain brake is not set by pulling the chain brake lever / hand guard towards the front handle as shown in Fig. 20. Refer to Safety-Chain Brake and Operation-Chain Brake Sections for additional information.
2. Remove the two (2) bar nuts (A, Fig. 21) and the clutch cover (B).
3. Remove and discard the plastic shipping spacer (C, Fig. 22) that has been installed on the bar studs in place of the bar for shipping purposes.
4. Adjust the chain tensioing pin (D) fully towards the rim sprocket (E) using the chain tensioing screw (F, Fig. 22).
5. The guide bar (G) contains a bar stud slot that fits over the bar studs (H). The guide bar also contains two chain tensioing pin holes (I) which fit over the chain tensioing pin and two lubrication holes. The bar is reversible and either tensioing pin hole may be utilized with the chain tensioing pin.
6. Place the guide bar (G) onto the bar studs (H) so that the chain tensioing pin (F) fits into the chain tensioing pin hole.
7. Position the guide bar (G) tip through the chain (L) loop as shown in Fig. 23. The cutters on the top of the guide bar should face toward the bar nose, in the direction of the chain rotation. See insert (M) in illustration below.
8. Fit the chain (G) over the rim sprocket (E) and into bar groove.



CAUTION: Severe damage can occur to the rim sprocket, clutch drum, guide bar and chain, if the chain is not correctly seated into the rim sprocket.

9. Replace the clutch cover (B) and install the two (2) bar nuts (A). Tighten the bar nuts finger tight only. The bar must be free to move for tension adjustment.



CAUTION: Failure to ensure that the chain tensioing pin is in the chain tensioing pin hole will result in severe damage to the chain saw during reassembly of the clutch cover.

NOTE: If the clutch cover does not slide on freely, check that the chain brake is not engaged. To disengage chain brake with clutch cover removed, grasp clutch cover as shown in Fig. 20 and pull back on chain brake lever / hand guard.

10. Remove all slack from chain by turning the chain tensioing screw (F) clockwise, assuring that the chain seats into the bar groove during tensioing (Fig. 25, page 16).
11. Lift the tip of the guide bar up to check for sag, see Fig. 26, pag. 16. Release the tip of the guide bar, and turn the chain tensioing screw (F) 1/2 turn clockwise. Repeat this process until sag does not exist.
12. Hold the tip of the guide bar up and tighten the bar nuts securely as shown in Fig. 27, page 16.

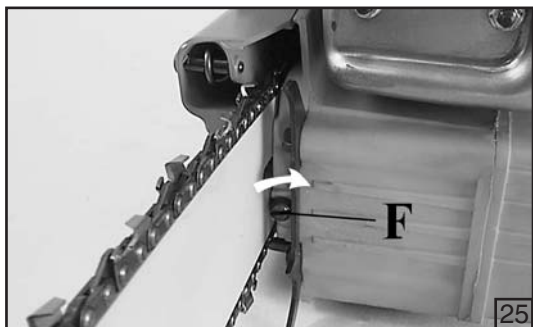

13. Chain is correctly tensioned when there is no slack on the underside of the guide bar, the chain is snug, but it can be turned by hand without binding, see Fig. 28. Ensure that the chain brake is not set.

NOTE: If chain is too tight, it will not rotate. Loosen bar nuts slightly and turn adjusting screw 1/4 turn counterclockwise. Lift the tip of the guide bar up and retighten bar nuts.



WARNING: Check the chain tension frequently when operating the chain saw. Never touch or adjust the chain while the motor is running. The saw chain is very sharp, always wear protective gloves when performing maintenance to the chain.

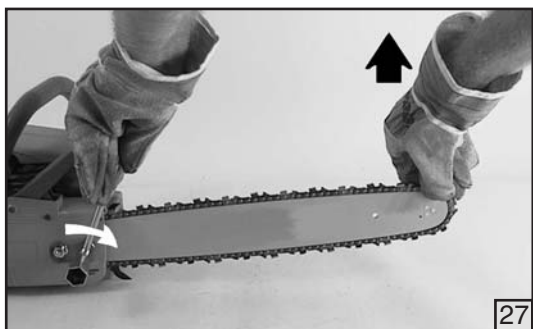

WARNING: The replacement chain must have the same or lower kickback characteristics as that originally supplied.



WARNING: If the saw is operated with a loose chain, the chain could jump off the guide bar and result in serious injury.



WARNING: Never start the saw with the sprocket cover loose.

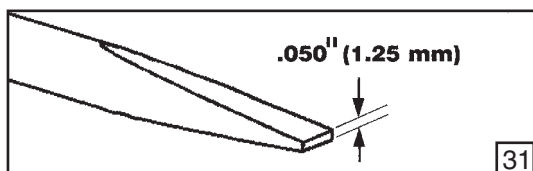
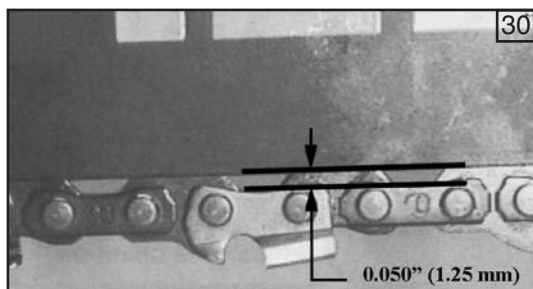
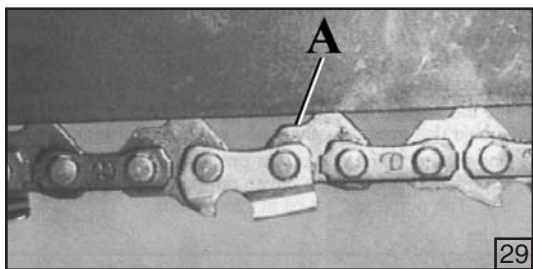

Chain Tension



WARNING: Never touch or adjust the chain while the motor is running. The saw chain is very sharp, always wear protective gloves when performing maintenance to the chain.

1. **Stop the engine before setting the chain tension.** Loosen the guide bar nuts slightly, turn the chain tensioning screw clockwise to tension the chain. Refer to Assembly-Assembling the Bar and Chain Section. Retighten guide bar nuts. A cold chain is correctly tensioned when there is no slack on the underside of the guide bar, the chain is snug, but it can be turned by hand without binding. For warm chain, see Item 3.
2. Chain must be retensioned whenever the flats (**A**) on the drive link tangs hang out of the bar groove. See Fig. 29.
3. During normal saw operation, the temperature of the chain will increase. The drive link tangs of a correctly tensioned warm chain will hang approximately .050\" (1.25 mm) out of the bar groove. See Fig. 30. To help determine the correct warm chain tension, the tip of the combination wrench (Fig. 31) can be used as a guide.



CAUTION: Chain tensioned while warm, may be too tight upon cooling. Check the "cold tension" before next use.



CAUTION: A new chain has to be retensioned more often than one that has been in use for some time.

Breaking-in the Chain

New chains will stretch and must be tightened frequently.

Lift the chain out of the bar groove and lubricate the bar groove with additional oil, see Fig. 32. Place the chain saw on a piece of cardboard or scrap plywood. Start the chain saw (refer to the Operation-Starting Engine Section) and allow it to run at moderate speed for approximately one (1) minute. **Stop the engine.** Check that the oil pump is working properly. The cardboard should have excess oil from the chain rotation if the oil pump is working properly, see Fig. 33. Adjust the chain tension (refer to Operation-Chain Tension Section). Start the saw again and make a few cuts in a log to heat up the chain. Stop the engine and re-adjust chain again. Repeat this process until the chain retains proper warm tension adjustment as shown in Fig. 30 in Operation-Chain Tensioning Section. **Never touch the ground with the chain.**



Bucking Spike

WARNING: Your chain saw may be fitted with an optional bucking spike (G, Fig. 34). The bucking spike is very sharp and can cause injury. Be extremely careful when working near the bucking spike.

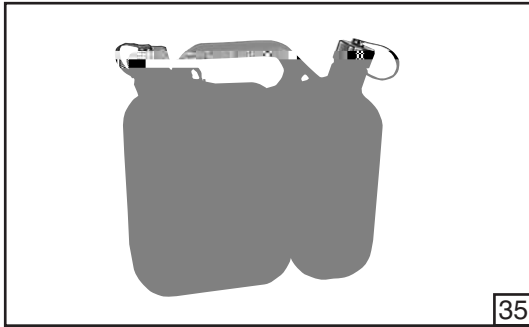

Fueling (Do Not Smoke!)

This product is powered by a 2-cycle engine and requires pre-mixing gasoline and 2-cycle oil. Pre-mix unleaded gasoline and 2-cycle engine oil in a clean container approved for gasoline (Fig. 35).

RECOMMENDED FUEL: THIS ENGINE IS CERTIFIED TO OPERATE ON UNLEADED GASOLINE INTENDED FOR AUTOMOTIVE USE WITH AN OCTANE RATING OF 89 ([R + M] / 2) OR HIGHER (Fig. 36).

Mix 2-Cycle Engine Oil with gasoline according to the instructions on the package. If 2-Cycle Engine Oil is not available, use a high quality 2-cycle engine oil for correct mixing proportion see table below (Fig. 37).

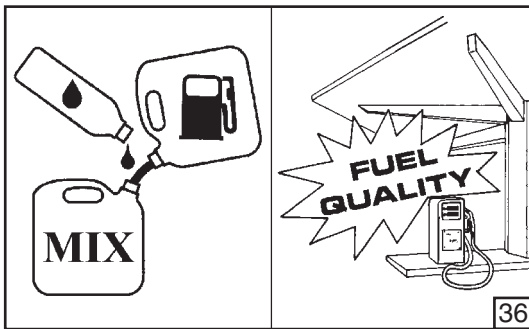

CAUTION: DO NOT USE AUTOMOTIVE OIL OR 2-CYCLE OUTBOARD OIL.

CAUTION: Never use a fuel with an alcohol percentage higher than 10%; gasohol up to 10% alcohol or E10 fuel are acceptable.

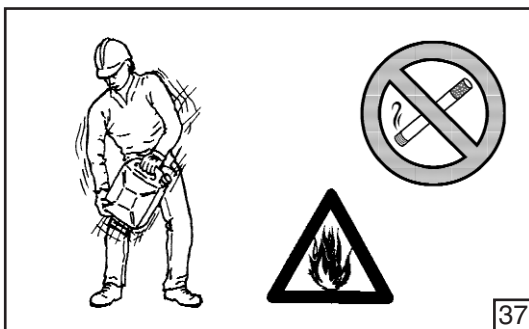

When using an Oxygenated Gasoline a good practice of Fuel Management is necessary.

Gasoline Oxygenated with alcohol readily takes up water when it is present; the water may be condensed out of humid air or be a contaminant in the fuel system, including tank.

CAUTION:

- Match your fuel purchases to your consumption; don't buy more than you will use in one or two months;
- Store gasoline in a tightly-closed container in a cool, dry place.

The use of Oxygenated Gasoline may cause the occurrence of vapor-lock easier.

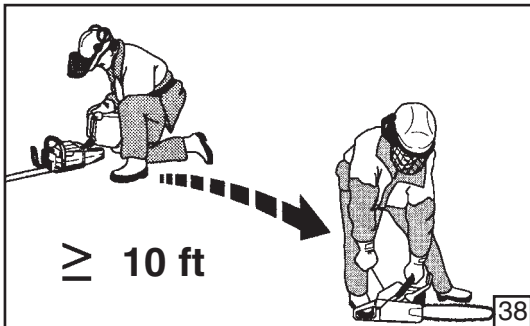

NOTE: 2-Cycle Engine Oil contains a fuel stabilizer and will stay fresh up to 30 days. **DO NOT** mix quantities larger than usable in a 30 day period. A 2-cycle oil containing a fuel stabilizer is recommended.

Fuel Mixture
2-Cycle Engine Oil (25:1) 4%

Gasoline	Oil
1 Gallon (US)	5.2 oz.
1 Liter	40 cc (40 ml)



Filling the Tank (Fig. 39)

WARNING: Follow safety instruction for fuel handling. Always shut off engine before fueling. Never add fuel to a machine with a running or hot engine. Move at least 10 feet (3 m) from refueling site before starting engine (Fig. 38). **DO NOT SMOKE!**

1. Clean surface around fuel cap to prevent contamination.
2. Loosen fuel cap slowly.
3. Carefully pour fuel mixture into the tank. Avoid spillage.
4. Prior to replacing the fuel cap, clean and inspect the gasket.
5. Immediately replace fuel cap and hand tighten. Wipe up any fuel spillage.

NOTE: It is normal for smoke to be emitted from a new engine during and after first use.

WARNING: Check for fuel leaks, if any are found, correct before use. Contact a Servicing Dealer if necessary.



Chain Oil System (Fig. 40)

The bar and chain require continuous lubrication. Lubrication is provided by the automatic oiler system when the oil tank is kept filled. Lack of oil will quickly ruin the bar and chain. Too little oil will cause overheating shown by smoke coming from the chain and/or discoloration of the bar. In freezing weather oil will thicken, making it necessary to thin bar and chain oil with a small amount (5 to 10%) of Diesel Fuel or kerosene. Bar and chain oil must be free flowing for the oil system to pump enough oil for adequate lubrication.

CAUTION: Never use waste oil. Always use biodegradable lubricant that is specific for bar and chain and that is better for the environment and chainsaw's parts.

CAUTION: Do not use dirty, used or otherwise contaminated oils. Damage may occur to the oil pump, bar, or chain.

WARNING: Do not use waste oil! Medical studies have shown that renewed contact with waste oil can cause skin cancer.

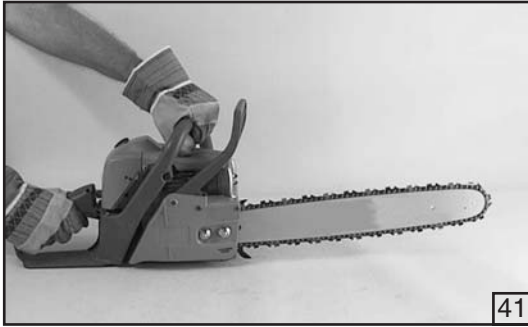

41

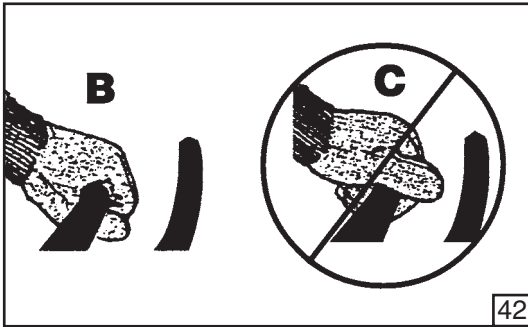

42

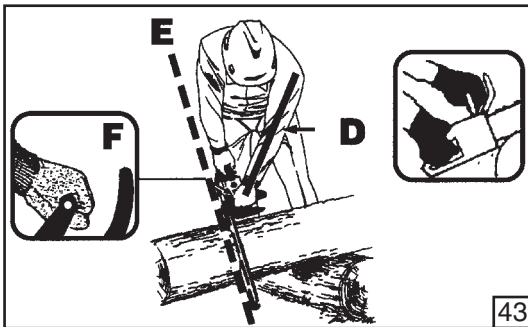

43

1. Fill the oil tank every time engine is fueled. Chain saw should use approximately one tank of oil per tank of fuel.
2. The automatic oil pump is a positive displacement pump operated through gears driven off the clutch drum assembly. The pump will not oil at idle speeds.

Preparation for Cutting

Proper Grip on Handles.

Refer to Safety Section for appropriate Safety Equipment.

1. Wear non-slip gloves for maximum grip and protection.



WARNING: Hold the saw firmly with both hands. Always keep your **LEFT HAND** on the front handlebar and your **RIGHT HAND** on the rear (throttle) handle as shown in Fig. 41, so that your body is to the left of the chain line. Never use a cross-handed grip, or any stance which would place your body or arm across the chain line. Left-handers should follow these instructions too.

2. Maintain a proper grip (B, Fig. 42) on the saw whenever the engine is running. The fingers should encircle the handlebar and the thumb is wrapped under the handlebar. This grip is least likely to be broken (by a kickback or other sudden reaction of the saw). Any grip in which the thumb and fingers are on the same side of the handle (C), is dangerous because a slight kick of the saw can cause loss of control.



WARNING:

Proper Cutting Stance (Fig. 43)

- Weight should be balanced on both feet - feet on solid ground.
- Keep arm with elbow locked in a "straight arm" position (D) to withstand any kickback force.
- Your body should always be to the left of the chain line (E).
- Thumb on underside of handlebar (F).

Basic Cutting Procedure

Practice cutting a few small logs using the following technique to get the "feel" of using your saw before you begin a major sawing operation.

1. Take the proper stance in front of the wood with the saw idling.
2. Accelerate the engine to full throttle just before entering the cut by squeezing the throttle trigger.
3. Begin cutting with the saw against the log.
4. Keep the engine at full throttle the entire time you are cutting.
5. Allow the chain to cut for you; exert only light downward pressure. If you force the cut, damage to the bar, chain, or engine can result.
6. Release the throttle trigger as soon as the cut is completed, allowing the engine to idle. **If you run the saw at full throttle without a cutting load, unnecessary wear or damage can occur to the chain, bar, and engine.**
7. Do not put pressure on the saw at the end of the cut.

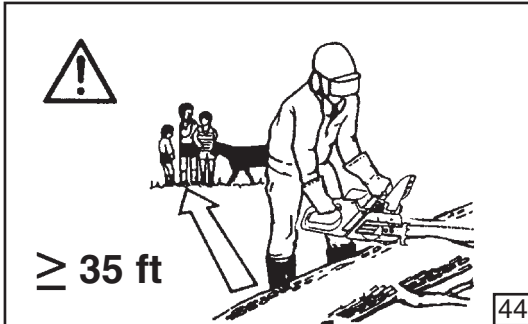

Work Area Precautions



WARNING: Cut only wood or materials made from wood. Do not cut metal, plastics, masonry, or non-wood building materials.

- Never allow children to operate your saw. Only allow others to use this chainsaw who have read this Operator's Manual or received adequate instructions for the safe and proper use of this chain saw.
- Keep everyone - helpers, bystanders, children, and animals a safe distance from the cutting area (**Fig. 44**). During felling operations, the safe distance should be at least twice the height of the largest trees in the felling area. During bucking operations, keep a minimum distance of 35 feet (10 m) between workers.
- Always cut with both feet on solid ground to prevent being pulled off balance.
- Do not cut above chest height, as a saw held higher is difficult to control against kickback forces.
- Do not fell trees near electrical wires or buildings. Leave this operation for professionals.
- Cut only when visibility and light are adequate for you to see clearly.
- **Do not cut from a ladder, this is extremely dangerous.** Leave this operation for professionals.
- Stop the saw if the chain strikes a foreign object. Inspect the saw and repair parts as necessary.
- Keep the chain out of dirt and sand. Even a small amount of dirt will quickly dull a chain and increase the possibility of kickback.
- Stop the engine before setting the saw down.
- Be particularly cautious and alert while wearing hearing protection because such equipment may restrict your ability to hear sounds indicating danger (calls, signals, warnings, etc).
- Be extremely cautious when working on slopes or uneven ground.
- When a chain saw is being used, a fire extinguisher should be available.



Starting The Engine



WARNING: Keep body to the left of the chain line. Never straddle the saw or chain, or lean over past the chain line. The chain brake must be engaged when starting the saw.

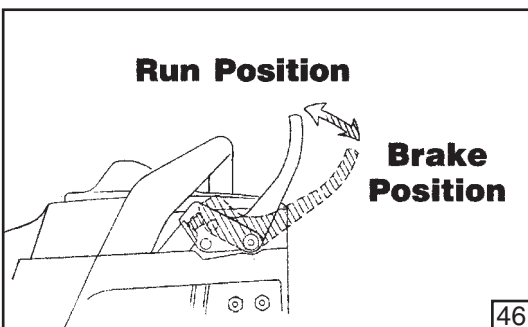

- Place the chain saw on level ground and ensure that no objects or obstructions are in immediate vicinity which could come in contact with the bar and chain. Hold the front handle firmly with the left hand and put your right foot onto the base of the rear handle, see Fig. 45.
- Set the chain brake by pushing the chain brake lever / hand guard forward (towards the bar), to the Brake Position as shown in Fig. 46. Refer to Safety-Chain Brake and Operation-Chain Brake Sections for additional information.

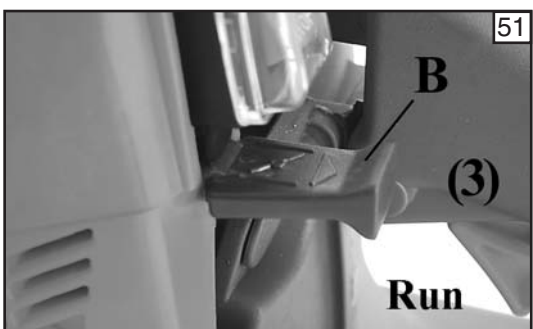
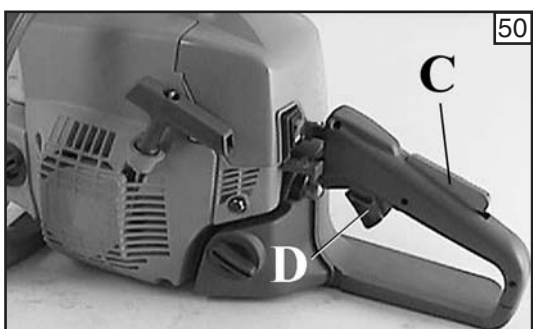
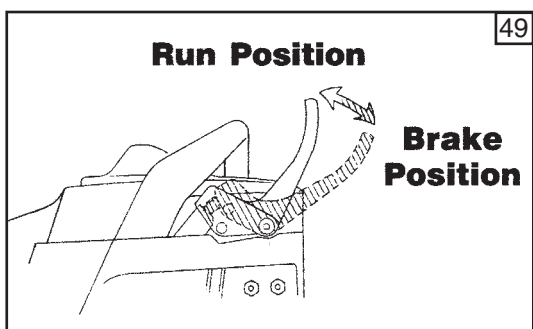
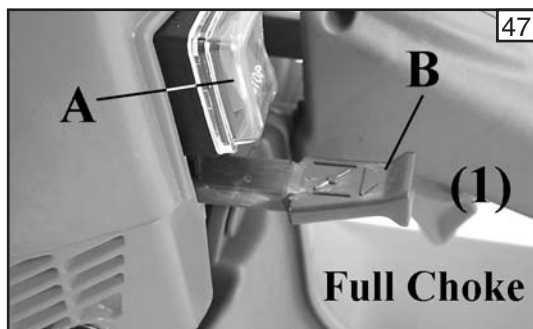

- Move the on/off switch (A) to the start position "I".
- Pull the choke lever (B) to the full choke (fully extended position or closed position 1, Fig.47). The half-throttle is automatically set when choke lever is set at Full Choke.
- Pull the starter rope until the first firing of the engine is heard (no more than five (5) pulls). **A new unit may require additional pulls.**
- Push the choke lever to the half choke position 2, Fig. 48.
- Pull the starter rope until the engine starts.
- Place chain brake lever / hand guard into the run position as shown in Fig. 49.
- Immediately after the engine has started, depress the throttle trigger lockout (C, Fig. 50), quickly squeeze and release the throttle trigger (D). This releases the throttle trigger lets the engine idle. Once the engine runs, warm up the machine by making a few cuts for approximate 30-60 seconds.

NOTE: the machine may require more than 60 seconds to warm up during extremely cold weather or at high altitudes.

- Push the choke lever completely in to the run position 3, Fig. 51.
- When pulling the starter rope, do not use the full extent of the rope as this can cause the rope to break. Do not let starter rope snap back. Hold the handle and let the rope rewind slowly.



WARNING: Do not cut material with the choke/fast idle lever at the FULL CHOKE position. Do not operate your chainsaw with the starting throttle lock engaged. Cutting with the starting throttle lock engaged does not permit the operator proper control of the saw or chain speed.

NOTE - STARTING WARM ENGINE:

Follow above starting instructions, but do not use the Full Choke position for start up again. To set fast idle for warm engine starting, pull choke out completely and push back in to the original Run Position.



WARNING: Weather conditions and altitude may affect carburetion. Do not allow bystanders close to the chain saw while adjusting the carburetor.



WARNING: Never attempt to start the chainsaw when the guide bar is in a cut or kerf.

Breaking-in the Engine

The engine reaches the maximum power after 5-8 hours of activity. During this period of breaking-in do not make the machine function idly at full throttle, to avoid excessive functioning stress.



CAUTION! – During the braking-in period do not vary the carburetion to obtain a presumed power increment; the engine can be damaged.

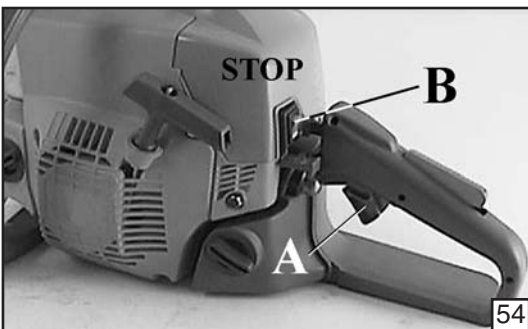
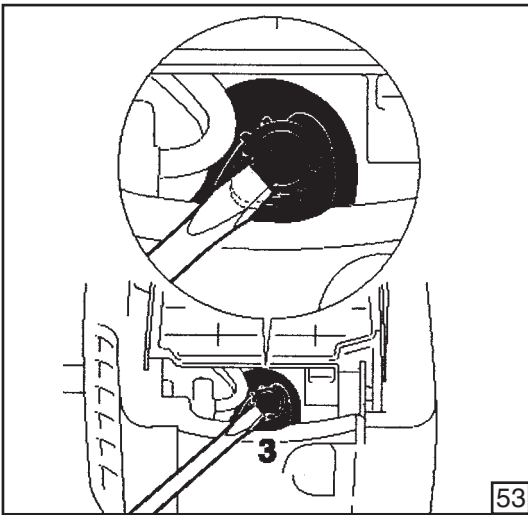
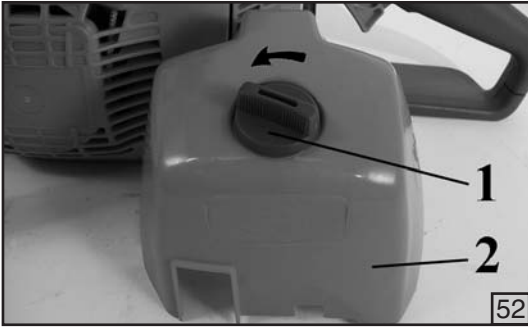

Difficult Starting (or starting a flooded engine)

The engine may be flooded with too much fuel if it has not started after 10 pulls. Flooded engines can be cleared of excess fuel by following the warm engine starting procedure listed above. Ensure the ON/STOP switch is in the ON position. Starting could require pulling the starter rope handle many times depending on how badly the unit is flooded. If engine fails to start refer to the TROUBLESHOOTING TABLE (page 35).

Engine is Flooded

If you did not move the choke lever to warm start, quickly enough after the engine began to fire, the combustion chamber is flooded.

- Set the on/off switch to STOP.
- Open the twist lock (1, Fig. 52) in the direction of the arrow.
- Remove the filter cover (2).
- Engage a suitable tool in the spark plug boot (3, Fig. 53).
- Pry off the spark plug boot.
- Unscrew and dry off the spark plug.
- Open the throttle wide.
- Pull the starter rope several times to clear the combustion chamber.
- Refit the spark plug and connect the spark plug boot, press it down firmly – reassemble the other parts.
- Set the on/off switch to I, the starting position.
- Set the choke lever to warm start – even if engine is cold.
- Now start the engine.

Stopping The Engine

Release the throttle trigger (A) and let the engine return to idle. To stop the engine, move the on/off switch (B) to the “STOP” position. Do not put the chain saw on the ground when the chain is still moving. For additional safety, set the chain brake when the saw is not in use.

In the event that the “STOP” position of the switch will not function, pull the choke lever out to the fully extended position  / Full Choke, refer to Fig. 54 to stop the engine.



CAUTION: The chain contracts as it cools down. If it is not slackened, it could damage the crankshaft and bearings.

Pre-operation checking



WARNING: THE SAW CHAIN SHOULD NEVER TURN AT IDLE. Turn the idle speed screw “T” counter-clockwise to reduce the idle RPM and stop the chain, or contact a Servicing Dealer for adjustment and discontinue use until the repair is made. Serious personal injury may result from the saw chain turning at idle.

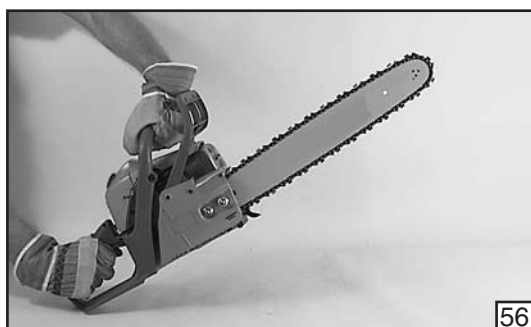
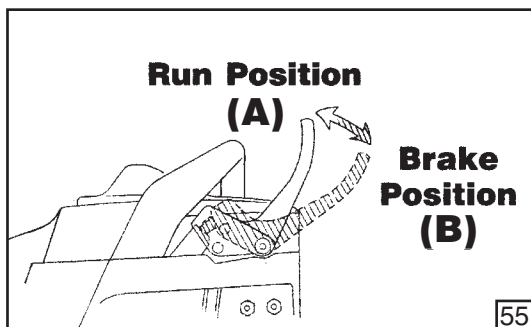

Chain Brake Operation

Refer to Safety-Chain Brake Section before use.

The chain brake Run Position (A, Fig. 55) and Brake Position (B) are illustrated below.

The chain brake operating condition should be checked prior to each use as follows:

1. Start the engine and grasp front and rear handles securely with both hands.
2. Pull the throttle trigger to bring the chain saw up to full speed. Using the back of your left hand, engage the chain brake by pushing the chain brake lever / hand guard toward the bar while the chain is rotating rapidly, see Fig, 56.
3. The chain brake should engage and stop the chain immediately, if not, take the saw to a Servicing Dealer for repair and discontinue use until the repair is made.
4. Reset the chain brake back into the run position by grasping the guide bar side (right side from operator's position) of the chain brake lever / hand guard and pull toward the front handle until an audible click is heard. See Fig, 57.



WARNING: If chain brake does not stop the chain immediately, take the saw to a Servicing Dealer for repair prior to use.



WARNING: An improperly maintained chain brake may increase the time needed to stop the chain after activation, or may not activate at all.

Tree Felling

Unusual Hazardous Tree Felling Conditions



WARNING: Do not fell trees during periods of high wind or heavy precipitation.



WARNING: Never cut, when visibility is poor or in very high or low temperatures or in freezing weather.



WARNING: Do not cut trees that have an extreme lean or hollow trunks rotten limbs or loose bark. Proper notching and back cutting cannot be performed on trees with extreme lean or hollow trunks. Have these trees dragged down with heavy equipment.



WARNING: Do not cut trees near electrical wires or buildings. If the tree makes contact with any utility line, the utility company should be notified immediately.



WARNING: Check the tree for damaged or dead branches that could fall and hit you during felling.

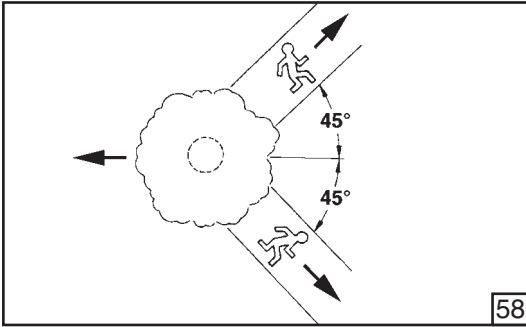

58

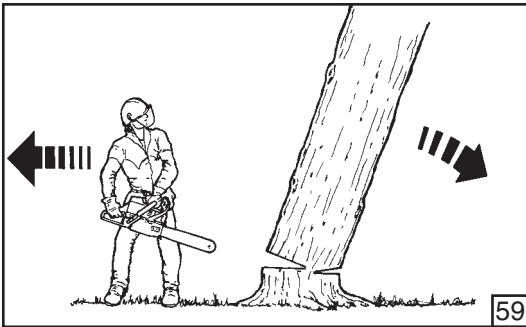

59

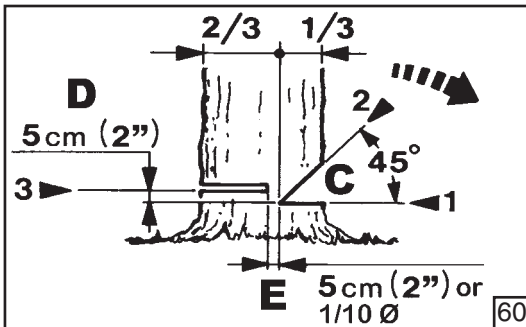

60

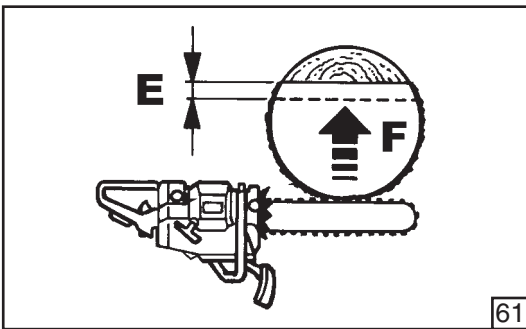

61

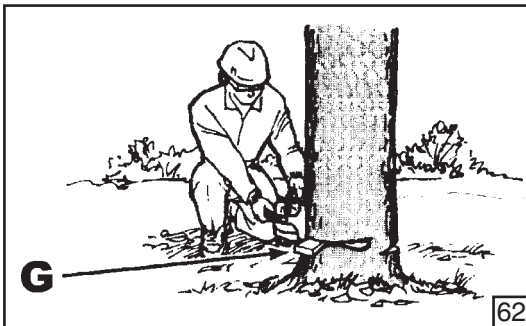

62



WARNING: Periodically glance at the top of the tree during the backcut to assure the tree is going to fall in the desired direction.



WARNING: If the tree starts to fall in the wrong direction, or if the saw gets caught or hung up during the fall, LEAVE THE SAW AND SAVE YOURSELF!

- Carefully plan your sawing operation in advance.
- Clear the work area. You need a clear area all around the tree so you can have secure footing.
- The chain saw operator should keep on the uphill side of the terrain as the tree is likely to roll or slide downhill after it is felled.
- Study the natural conditions that can cause the tree to fall in a particular direction.

Look for decay and rot. If the trunk is rotted, it can snap and fall toward the operator.

Make sure there is enough room for the tree to fall. Maintain a distance of 2-1/2 tree lengths from the nearest person or other objects. Engine noise can drown out a warning call. Remove dirt, stones, loose bark, nails, staples, and wire from the tree where cuts are to be made.

1. Pick your escape route (or routes in case the intended route is blocked). Clear the immediate area around the tree, and make sure there are no obstructions in your planned path of retreat. Clear path of safe retreat (Fig. 58) 45° from planned line of fall (Fig. 59).
2. Consider the force and direction of the wind, the lean and balance of the tree, and the location of large limbs. These things influence the direction in which the tree will fall. Do not try to fell a tree along a line different from its natural line of fall.
3. Cut a notch (C, Fig. 60) about 1/3 the diameter of the trunk in the side of the tree. Make the cuts of the notch so they intersect at a right angle to the line of fall. This notch should be cleaned out to leave a straight line. To keep the weight of the wood off the saw, always make the lower cut of the notch before the upper cut.
4. The backcut is always made level and horizontal, and at a minimum of 2 inches (5 cm) above the horizontal cut of the notch (D).
5. Never cut through to the notch. Always leave a band of wood between the notch and back cut (approximately 2 inches (5 cm) or 1/10 the diameter of the tree). This is called "hinge" (E) or "hingewood." It controls the fall of the tree and prevents slipping or twisting or shoot-back of the tree off the stump.
6. On large diameter trees, stop the back cut (F, Fig. 61) before it is deep enough for the tree to either fall or settle back on the stump. Then insert soft wooden or plastic wedges (G, Fig. 62) into the cut so they do not touch the chain. The wedges can be driven in, little by little, to help jack the tree over.
7. As tree starts to fall, stop the engine and put saw down immediately. Retreat along cleared path, but watch the action in case something falls your way.



WARNING: Never cut through to the notch when making a backcut. The hinge controls the fall of the tree, this is the section of wood between the notch and backcut.

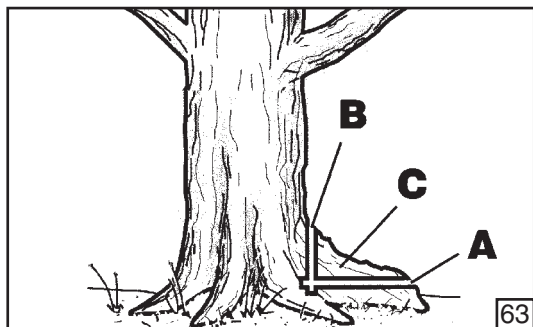

DO NOT cut down a partially fallen tree with your saw. Be extremely cautious with partially fallen trees that may be poorly supported. When a tree doesn't fall completely, set the saw aside and pull down the tree with a cable winch, block and tackle, or tractor.

Buttress Roots

A buttress root is a large root extending from the trunk of the tree above ground. Large buttress roots should be removed prior to felling. Make the horizontal cut (**A**, Fig. 63) into the buttress first, followed by the vertical cut (**B**). Remove the resulting loose section (**C**) from the work area. Utilize the proper instructions from the Operation-Tree Felling section of the manual after the large buttress roots have been removed.

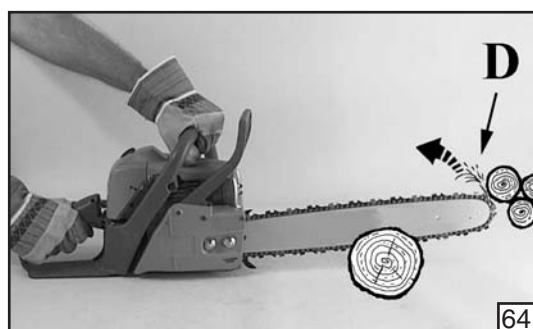

Bucking

Bucking is the term used for cutting a fallen tree to the desired log length.

- Cut only one log at a time.



WARNING: Support small logs on a saw horse or another log while bucking. Never allow another person to hold the log while cutting and never hold the log with your leg or foot.



WARNING: Keep a clear cutting area. Make sure that no objects can contact the guide bar nose and chain during cutting, this can cause kickback (**D**, Fig. 64).



WARNING: During bucking operations always stand on the uphill side so that the cut-off section of the log can not roll over you.



WARNING: If saw becomes pinched or hung in a log, don't try to force it out. You can lose control of the saw resulting in injury and/or damage to the saw. Stop the saw, drive a wedge of plastic or wood into the cut until the saw can be removed easily (**E**, Fig. 65). Restart the saw and carefully reenter the cut. Do not attempt to restart your saw when it is pinched or hung in a log.

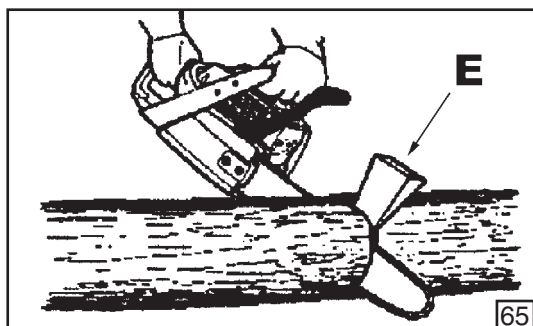

WARNING: Do not stand on the log being cut. Any portion can roll causing loss of footing and control. Do not cut in an area where logs, limbs, and roots are tangled. Drag the logs into a clear area before cutting by pulling out exposed and cleared logs first.

Bucking with a Wedge

If the wood diameter is large enough for you to insert a soft bucking wedge (**E**, Fig. 65) without touching the chain, you should use the wedge to hold the cut open to prevent pinching.

Logs Under Stress (Fig. 66-67)

Make the first bucking cut **(F)** 1/3 of the way through the log and finish with a 2/3 cut **(G)** on the opposite side. As the log is being cut, it will tend to bend. The saw can become pinched or hung in the log if you make the first cut deeper than 1/3 of the diameter of the log.

Give special attention to logs under stress to prevent the bar and chain from pinching.

Types of Cutting Used**Overbucking (Fig. 68)**

Begin on the top side of the log with the bottom of the saw against the log; exert light pressure downward.

Underbucking (Fig. 69)

Begin on the under side of the log with the top of the saw against the log; exert light pressure upward. During underbucking, the saw will tend to push back at you. Be prepared for this reaction and hold the saw firmly to maintain control.

WARNING: Never turn saw upside down to undercut. The saw cannot be controlled in this position. Always make your first cut on the compression side of the log. The compression side of the log is where the pressure of the log's weight is concentrated.

Limbing and Pruning

WARNING: Be alert for and guard against kickback. Do not allow the moving chain to contact any other branches or objects at the nose of the guide bar when limbing or pruning. Allowing such contact can result in serious injury.

- Work slowly, keeping both hands on the saw with a firm and proper grip. Maintain secure footing and balance **(Fig. 70)**.
- Keep the tree between you and the chain while limbing **(A, Fig. 71)**. Cut from the side of the tree opposite the branch you are cutting.
- Do not cut from a ladder, this is extremely dangerous **(Fig. 70)**. Leave this operation for professionals.
- Do not cut above chest height as a saw held higher is difficult to control against kickback.
- Be alert for springback. Watch out for branches that are bent or under pressure. Avoid being struck by the branch or the saw when the tension in the wood fibers is released.
- Keep a clear work area. Frequently clear branches out of the way to avoid tripping over them.

WARNING: Never climb into a tree to limb

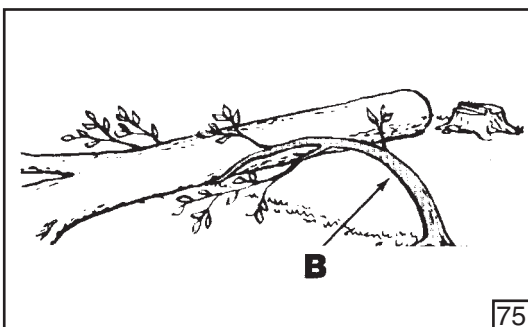
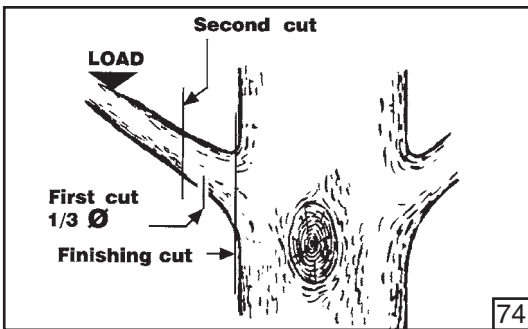
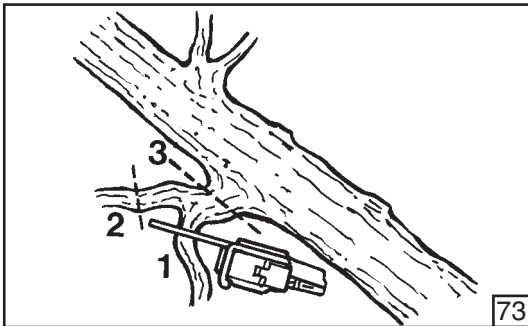
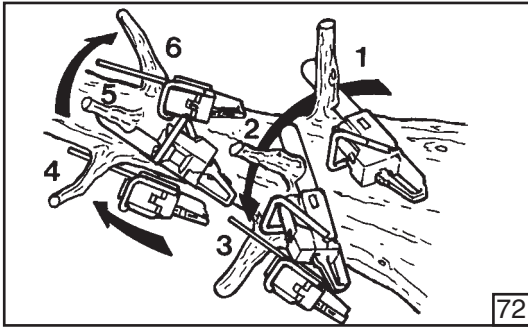

Limbing Operation (Fig. 72-73)

- Always limb a tree after it is cut down. Only then can limbing be done safely and properly.
- Leave the larger limbs underneath the felled tree to support the tree as you work.
- Start at the base of the felled tree and work toward the top, cutting branches and limbs. Remove small limbs with one cut.
- Keep the tree between you and the chain. Cut from the side of the tree opposite the branch you are cutting.
- Remove larger, supporting branches with the cutting techniques described in BUCKING WITHOUT A SUPPORT.
- Always use an overcut to cut small and freely hanging limbs. Undercutting could cause limbs to fall and pinch the saw.

Pruning Operation (Fig. 74)

- When pruning trees it is important not to make the flush cut next to the main limb or trunk until you have cut off the limb further out to reduce the weight. This prevents stripping the bark from the main member.
- Underbuck the branch 1/3 through for your first cut, your second cut should overbuck to drop the branch off.
- Now make your finishing cut smoothly and neatly against the main member so the bark will grow back to seal the wound.

WARNING: If the limbs to be pruned are above chest height, hire a professional to perform the pruning.

Springpoles

A springpole (B, Fig. 75) is any log, branch, rooted stump, or sapling which is bent under tension by other wood so that it springs back if the wood holding it is cut or removed. On a fallen tree, a rooted stump has a high potential of springing back to the upright position during the bucking cut to separate the log from the stump. Watch out for springpoles. They are potentially dangerous.

WARNING: Springpoles are dangerous and could strike the operator, causing the operator to lose control of the chain saw. This could result in severe or fatal injury to the operator.

Please note that the following maintenance intervals apply for normal operating conditions only. If your daily work requires longer than normal or harsh cutting conditions are present the suggested intervals should be shortened accordingly.		Before Each Use	After Each Refueling Stop	After Finishing Daily Work	Weekly	Monthly	If Damaged or Faulty	As Required
Complete Machine	Inspect (Leaks, Cracks, and Wear)	X	X					
	Clean			X				
Controls (Ignition Switch, Choke Lever, Throttle Trigger, Trigger Interlock)	Check Operation	X	X					
Chain Brake	Check Operation	X	X					
	Clean and Oil				X			
	Check by Dealer						X	X
Fuel Tank	Inspect (Leaks, Cracks, and Wear)	X	X					
	Clean					X		
Oil Tank	Inspect (Leaks, Cracks, and Wear)	X	X					
	Clean					X		
Fuel Filter	Inspect				X			
	Clean, Replace Filter Element						X	Every 6 Months
Chain Lubrication	Check Output	X	X					
Saw Chain	Inspect (Damage, Sharpness, and Wear)	X	X					
	Check Tension	X	X					
	Sharpen (Check Gauge Depth)						X	X
Guide Bar	Inspect (Damage and Wear)	X	X					
	Clean Bar groove and Oil Passages	X						
	Rotate				X			
	Lubricate Sprocket Nose				X			
	Deburr				X			
	Replace						X	X
Rim Sprocket	Inspect (Damage and Wear)				X			Replace with every new chain
Clutch Drum	Inspect (Damage, and Wear)				X			
	Replace						X	
Chain Catcher	Inspect (Damage, and Wear)	X	X					
	Replace						X	X
Spark Arrestor Screen (In Muffler)	Inspect (Damage and Wear)				X			
	Clean or Replace						X	X
All Accessible Screws and Nuts (Not Adjusting Screws)	Inspect	X						
	Retighten				X			
Air Filter	Clean	X						X
	Replace						X	Every 6 Months
Cylinder Fins	Clean					X		
Starter System Vents	Clean			X				
Starter Rope	Inspect (Damage and Wear)				X			
	Replace						X	
Carburetor	Check Idle (Chain must not rotate at Idle)	X	X					
Spark Plug	Check Electrode Gap					X		
	Replace						X	Every 6 Months
Vibration Mounts	Inspect (Damage, and Wear)				X			
	Replace by Dealer						X	X

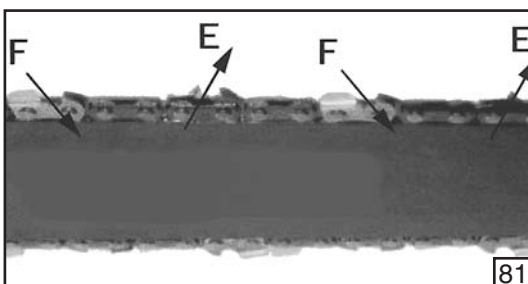
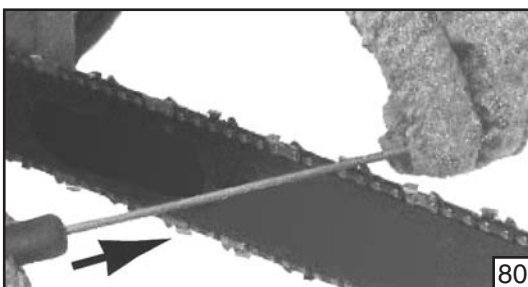
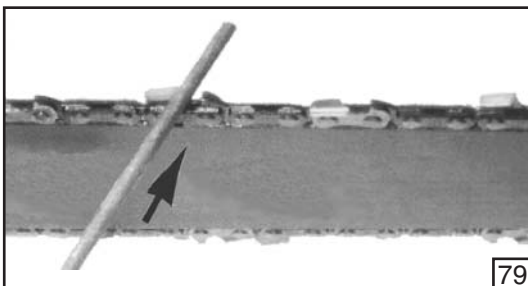
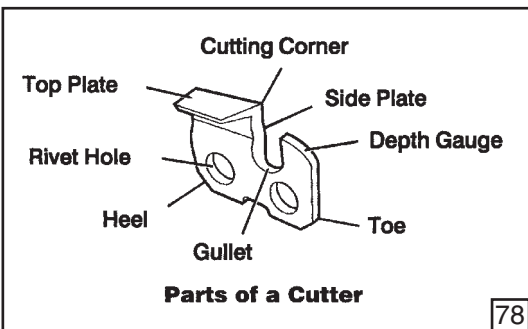
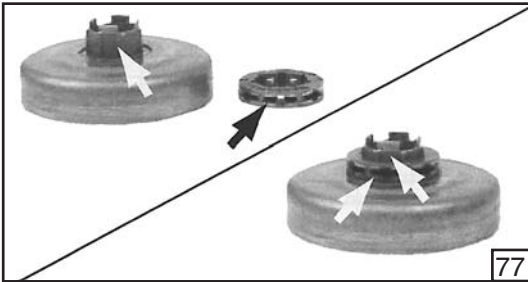
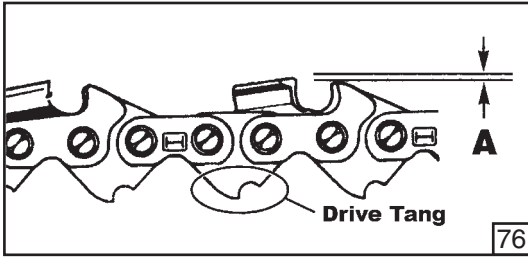

Chain Maintenance

Use only Dual Raker low-kickback chain on this saw. This fast-cutting chain will provide kickback reduction when properly maintained.

For smooth and fast cutting, raker chain needs to be maintained properly. The chain requires sharpening when the wood chips are small and powdery, the chain must be forced through the wood during cutting, or the chain cuts to one side. During maintenance of your chain, consider the following:

1. Improper filing angle of the side plate can increase the risk of a severe kickback.
2. Raker (depth gauge) clearance (**A, Fig. 76**): Too much increases the potential for kickback; not enough decreases cutting ability.
3. If cutter teeth have hit hard objects such as nails and stones, or have been abraded by mud or sand on the wood, have Servicing Dealer sharpen chain.
4. In rare instances drive tangs could flare resulting in chain not rotating freely. Replace chain if necessary.

NOTE: Inspect the rim sprocket for wear or damage when replacing the chain. If signs of wear or damage are present in the areas indicated in Fig. 77, have the rim sprocket replaced by a Servicing Dealer.

How to Sharpen the Cutters (Fig. 78)

Be careful to file all cutters to the specified angles and to the same length, as fast cutting can be obtained only when all cutters are uniform.

1. Wear gloves for protection. Tighten the chain tension enough that the chain does not wobble. Do all of your filing at the mid-point of the bar. See Operation-Chain Tension.
2. Use a 3/16" diameter round file and holder.
3. Keep the file level with the top plate of the tooth as shown in Fig. 79. Do not let the file dip or rock.
4. Using light but firm pressure, stroke towards the front corner of the tooth as shown in Fig. 80. Lift file away from the steel on each return stroke.
5. Put a few firm strokes on every tooth. File all left hand cutters (**E, Fig. 81**) in one direction. Then move to the other side and file the right hand cutters (**F**) in the opposite direction. Occasionally remove filings from the file with a wire brush.



CAUTION: Dull or improperly sharpened chain can cause excessive engine speed during cutting which may result in severe engine damage.



WARNING: It is absolutely essential to comply with the angles and dimensions specified below. If the saw chain is incorrectly sharpened – and in particular if the depth gauge is set too low – there is a risk of increased kickback of the chainsaw, with resulting risk of injury.

Failure to replace or repair damaged chain can cause serious injury.

The saw chain is very sharp, always wear protective gloves when performing maintenance to the chain.

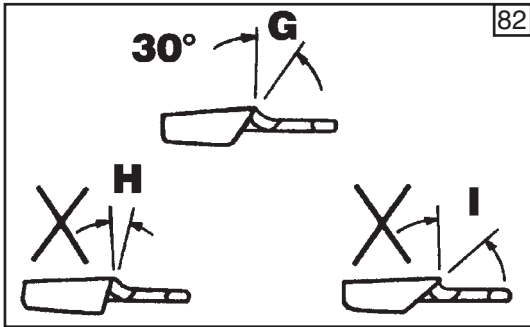

Top Plate Angle

File holders are marked with guide marks to align file properly to produce correct TOP PLATE ANGLE (Fig. 82).

- G) CORRECT- 30°
- H) LESS THAN 30° - For Cross Cutting.
- I) MORE THAN 30°- Feathered Edge Dulls Quickly.

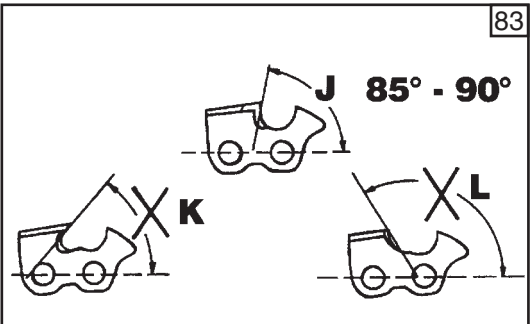

Side Plate Angle (Fig. 83)

J) CORRECT- 85° - 90°
Produced automatically if correct diameter file is used in file holder.

K) "HOOK"- "Grabs" and dulls quickly. Increases potential of KICKBACK.

L) BACKWARD SLOPE- Needs too much feed pressure, causes excessive wear to bar and chain.

Results from using a file with diameter too large, or file held too high.

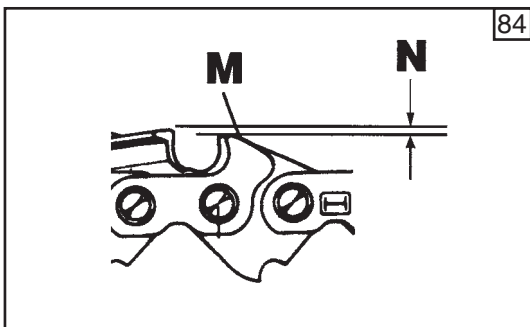

Depth Gauge Clearance

1. The depth gauge (M, Fig. 84) should be maintained at a clearance (N) between .020 (0.5 mm) and .024" (0.6 mm). Use a depth gauge tool for checking the depth gauge clearances.
2. Every time the chain is filed, check the depth gauge clearance.

Use a Flat File and a Depth Gauge Jointer to lower all gauges uniformly (Fig. 85).

- P) FLAT FILE
- Q) DEPTH GAUGE JOINTER

Depth gauge jointers available in .020" to .035" (0.5 mm to 0.9 mm). After lowering each depth gauge, restore original shape by rounding the front (R). Be careful not to damage adjoining drive links with the edge of the file.

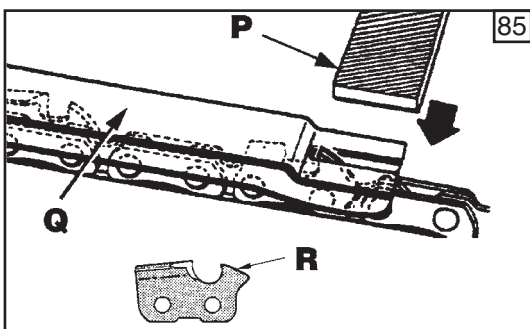

CAUTION: After sharpening, clean the chain thoroughly, remove filings or grinding dust – lubricate the chain thoroughly.

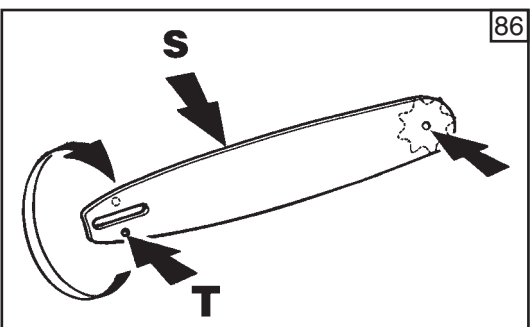

Guide Bar Maintenance

Every day of use, reverse the guide bar on the saw to distribute the wear for maximum bar life (see Fig. 86). The bar should be cleaned every day of use and checked for wear and damage.

Feathering or burring of the bar rails is a normal process of bar wear. Such faults should be smoothed with a file or stone as soon as they occur.

A bar with any of the following faults should be replaced:

- Wear inside the bar rails which permits the chain to lay over sideways.
- Bent guide bar.
- Cracked or broken rails.
- Spread rails.

In addition, guide bars with a sprocket at their tip must be lubricated periodically with a grease syringe to extend the guide bar life. Turn the guide bar and check that the lubrication holes (T) and chain groove (S) are free from impurities.

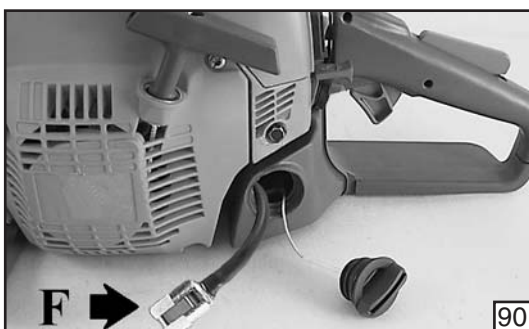
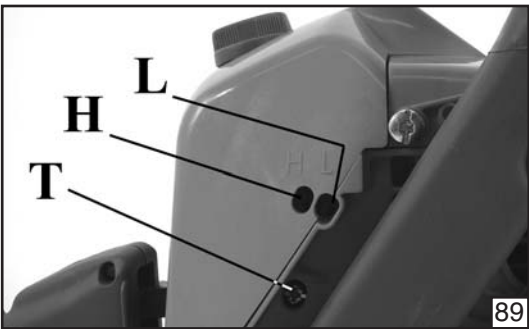
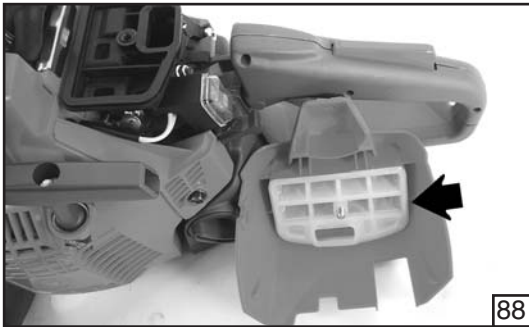
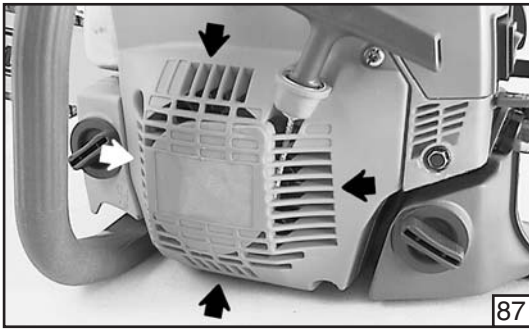

Carburetor Adjustment

Before adjusting the carburetor, clean the starter cover vents as shown in Fig. 87, and air filter as shown in Fig. 88, refer to Operation-Starting Unit and Maintenance-Air Filter Sections for details. Allow the engine to warm up prior to carburetor adjustment.

This engine is designed and manufactured in order to comply with CARB (California Air Resources Board) and EPA (Environmental Protection Agency) regulations.

The carburetor is factory set and should not require adjusting. Exhaust Emission Control System includes ignition system, air inlet system and carburetor.

The carburetor will permit only limited adjustment of the “L” (Low Jet) and “H” (High Jet) needles (within 1/4 of turn Fig. 89). Any adjustment should be done by a Servicing Dealer.

Under no circumstances should the “L” (Low Jet) and (H) (High Jet) needles be forced outside the range of adjustment.



WARNING: Serious damage can occur to the engine if improper adjustments are made to the “L” and “H” needles. Do not force the “L” and “H” needles outside the adjustment range in such case the engine will not run in compliance with emissions regulations.

Idle Speed Adjustment

- If the engine starts, runs, and accelerates but will not idle; turn the idle speed screw “T” clockwise to increase idle speed (Fig. 89).
- If the chain turns at idle, turn the idle speed screw “T” counterclockwise to reduce the idle RPM and stop the chain movement. If the saw chain still moves at idle speed, contact a Servicing Dealer for adjustment and discontinue use until the repair is made.

Fuel Filter

Check the fuel filter (F, Fig. 90) periodically. Replace it if contaminated or damaged.

Air Filter



WARNING: Do not clean filter in gasoline or other flammable solvent to avoid creating a fire hazard or producing harmful evaporative emissions.

Rotate the knob (G, Fig. 91) counterclockwise, remove air filter cover (H) and check the air filter (I) each day; shake the filter and clean with a soft brush. If heavily contaminated, clean with soapy water, rinse and dry thoroughly prior to installing. Reinstall the air filter into cover. Place the air filter cover onto the chain saw, rotate knob to latch air filter cover into place.

A used air filter can never be completely cleaned. It is advisable to replace your air filter with a new one after six month of operation.



CAUTION: Never run the engine without the air filter, serious damage could result. Make sure the air filter is correctly placed in the air filter cover before reassembly. Always replace damaged filters. Do not clean a filter with a brush.



Starter Unit

Use a brush to keep the cooling vents of the starter assembly free and clean of debris (Fig. 92).



WARNING: The coil spring is under tension and could fly apart causing serious injuries. Never try to disassembly or modify it.

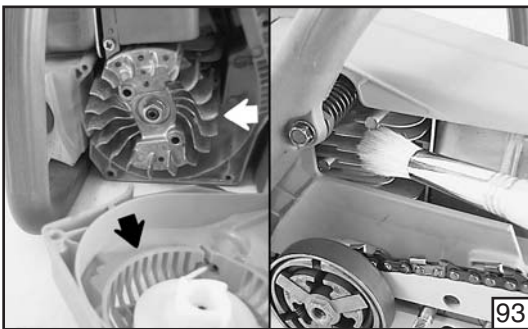

Engine

Clean the cylinder & flywheel fins with compressed air or a brush periodically (Fig. 93). Dangerous overheating of engine may occur due to impurities on the cylinder.



WARNING: Never run the saw without all the parts, including the drivecase cover and starting housing, securely in place. Because parts can fracture and pose a danger of thrown objects, leave repairs to the flywheel and clutch to trained Servicing Dealers.

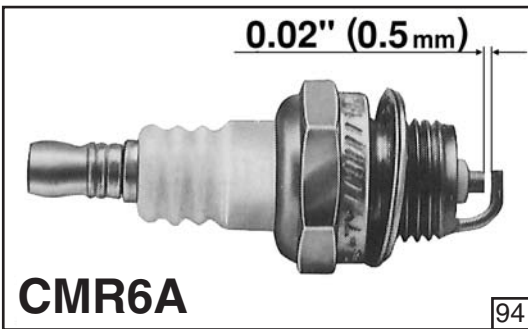

Spark Plug

This engine uses a NGK CMR6A with .02" (0.5 mm) electrode gap (Fig. 94). Use an exact replacement and replace every six months or more frequently, if necessary.



WARNING: Never test the ignition system with ignition wire connector removed from spark plug or with unseated spark plug, since uncontained sparking may cause a fire. A loose connection between spark plug terminal and ignition wire connector in the boot may create arcing that could ignite combustible fumes and cause a fire.

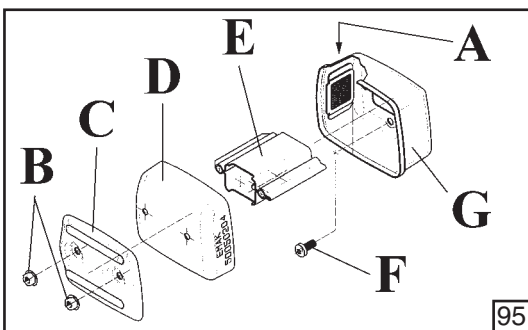

Use only resistor type spark plugs of the approved range.

Factors such as:

- too much oil in fuel mix;
 - dirty air filter;
 - unfavourable running conditions, e.g. operating at part load;
- may result in rapid deterioration of the spark plug.

Spark Arresting Muffler

The chainsaw is provided with a Spark Arrester System p.n. 50050204 (Fig. 95) complying with the requirements of SAE J335 standard; you can check the p.n. of the Spark Arrester System on the muffler itself.



WARNING: A faulty or altered spark arrester system screen can create a fire hazard.

Through normal use the screen can become dirty and should be inspected weekly and cleaned as required.

To clean:

- Allow the muffler to cool.
- Remove the two (2) muffler nuts (B).

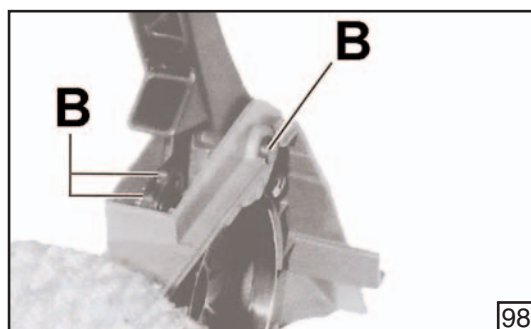
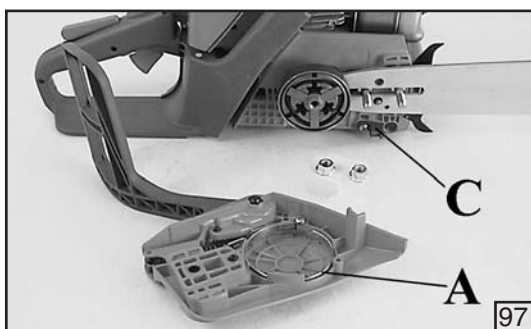
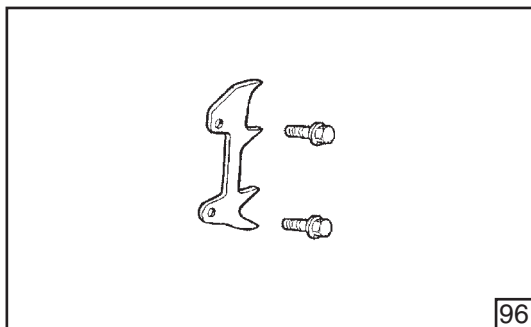

- Remove the muffler shield (C), cover (D) and diffuser (E).
- Remove the muffler body screw (F) and muffler body (G).
- Clean and inspect the spark arrester screen (A).
- Reassemble components in reversed order of removal and torque the screw to 45 in/lbs (4.9 Nm) and the muffler nuts to 70 in/lbs (7.9 Nm).

WARNING: If the spark arrester screen is damaged, faulty or deteriorated, replace the muffler body or entire muffler assembly.

The Spark Arrester System needs a periodic and accurate maintenance and cleaning, in particular:

- check periodically the spark arrester screen and substitute it when holes, bends or deformations appear;
- check carefully if dust, debris or organic material is in contact with parts of the Spark Arrester System; check especially the gap between the muffler and the shield; clean it often with tools or shop air.

In this chainsaw the spark arrester screen is integral part of the inner half of the muffler body; if the screen needs to be replaced, please order the whole inner part p.n. 50050204A (G, Fig. 95 page 33).

One spiked bumper p.n. 50062023 (Fig. 96) can to be mounted, as provided on the chainsaw in the box.

WARNING: Do not operate your chainsaw if the muffler is damaged, missing or modified. An improperly maintained muffler will increase the risk of fire and hearing loss.

Chain Brake

If the chain brake does not work properly, remove the clutch cover and clean the chain brake components. Check for wear on the brake band (A, Fig. 97) and replace if worn or deformed.

WARNING: If the brake band is worn too thin it may break when the chain brake is triggered. With a broken brake band, the chain brake will not stop the chain. The chain brake should be replaced by an authorized service dealer if any part is worn to less than 0.02" (0.6 mm) thick. Repairs on a chain brake should be made by an authorized service dealer. Take your unit to the place of purchase if purchased from a servicing dealer, or to the nearest authorized service dealer.

Always keep the chain brake mechanism clean and lightly lubricate the linkage (B, Fig. 98).

Always test the chain brake performance after servicing or cleaning per the Operation - Chain Brake Section.

WARNING: Check and, if damaged, replace the chain catcher / safety stop (C, Fig. 97).

Using Troubleshooting Chart



WARNING: Always stop unit and disconnect spark plug before performing all of the recommended remedies below except remedies that require operation of the unit.

When you have checked all the possible causes listed and you are still experiencing the problem, see your Servicing Dealer. If you are experiencing a problem that is not listed in this chart, see your Servicing Dealer for service.

PROBLEM	POSSIBLE CAUSE	SOLUTION
Engine will not start or will run only a few seconds after starting. (Make sure Ignition switch is in start position "I")	1. No spark 2. Flooded engine.	1. Check Spark. Remove air filter cover. Remove spark plug from cylinder. Reattach the spark plug wire and lay spark plug on top of cylinder. Pull the starter rope and watch for spark at spark plug tip. If there is no spark, repeat test with a new spark plug (CMR6A). 2. With the ignition switch off, remove spark plug. Move choke lever to Run position (pushed in completely) and pull starter cord 15 to 20 times. This will clear excess fuel from engine. Clean and reinstall spark plug. Pull the choke lever all out and then insert it completely in order to activate the semi-acceleration device. Pull starter three times with choke lever at run. If engine does not start, move choke lever to choke and repeat normal starting procedure. If engine still fails to start, repeat procedure with a new spark plug.
Engine starts but will not accelerate properly:	Carburetor requires "L" (Low jet) adjustment.	* Contact a Servicing Dealer for carburetor adjustment.
Engine starts but will not run properly at high speed.	Carburetor requires "H" (High jet) adjustment.	* Contact a Servicing Dealer for carburetor adjustment.
Engine does not reach full speed and / or emits excessive smoke	1. Check oil fuel mixture. 2. Air filter dirty. 3. Spark arrester screen dirty. 4. Carburetor requires "H" (High jet) adjustment.	1. Use fresh fuel and the correct 2-cycle oil mix. 2. Clean per instruction in Maintenance-Air Filter Section. 3. Clean per instructions in Maintenance-Spark Arresting Muffler Section. 4. * Contact a Servicing Dealer for carburetor adjustment.
Engine starts, runs, and accelerates but will not idle.	Carburetor requires adjustment.	Turn idle speed screw "T" clockwise to increase idle speed. (If chain turns at idle, turn idle speed screw "T" counterclockwise to decrease speed); see Operation-Carburetor Adjustment.
Bar and Chain Running Hot and Smoking	1. Chain oil tank empty. 2. Chain tension too tight. 3. Oiler function.	1. Oil tank should be filled every time that fuel tank is filled. 2. Tension chain per instructions in Operation-Chain Tension section. 3. Run at full throttle 15 to 30 seconds. Stop saw and check for oil dripping from bar tip guard and guide bar. If oil is present the chain may be dull or bar may be damaged. If no oil contact a Servicing Dealer.
Engine starts and runs, but chain is not rotating	1. Chain brake engaged. 2. Chain tension too tight. 3. Guide bar and chain assembly. 4. Chain and/or guide bar damaged. 5. Clutch drum and/or rim sprocket damaged.	1. Release chain brake, see Operation-Chain Brake Section. 2. Tension chain per instructions in Operation-Chain Tension section. 3. Refer to Assembly-Assembling the Bar and Chain Section. 4. Refer to Maintenance-Chain and/or Maintenance-Guide Bar Section. 5. Replace if necessary - contact a Servicing Dealer.



WARNING: Never touch the chain while the engine is running.

***Note:** This engine complies with EPA (Environmental Protection Agency) and CARB (California Air Resource Board) regulations which require exhaust emission control. As a result, the carburetor adjustment needles are equipped with plastic caps that limit the rotation from the original factory adjustment. If your unit exhibits specific performance problems that can not be corrected by the Trouble Shooting Section, the unit should be taken to a Servicing Dealer for repair.

Storing Chain Saw



WARNING: Stop engine and allow to cool, and secure the unit before storing or transporting in a vehicle. Store unit and fuel in an area where fuel vapors cannot reach sparks or open flames from water heaters, electric motors or switches, furnaces, etc. Store unit with all guards in place. Position so that any sharp object cannot accidentally cause injury to passersby. Store the unit out of reach of children and other unauthorized persons.

1. Drain and clean the fuel tank in a well ventilated area.
2. Drain all fuel from tank into a container approved for gasoline. Run engine until it stops. This will remove all fuel-oil mix which could become stale and leave varnish and gum in the fuel system.
3. Clean all foreign material from the saw. Keep away from corrosive agents such as garden chemicals and de-icing salts.
4. Abide by all Federal and local regulations for the safe storage and handling of gasoline. Excess fuel should be used in other 2-cycle engine powered equipment.



CAUTION: It is important to prevent gum deposits from forming in essential fuel system parts such as the carburetor, fuel filter, fuel hose, or fuel tank during storage. Alcohol blended fuels (called gasohol or E10 or using ethanol, methanol) can attract moisture which leads to fuel mixture separation and formation of acids during storage. Acidic gas can damage the engine.

TECHNICAL DATA

MT3600

ENGINE:

Displacement: 2.15 cu. in (35.2 cc)
Bore: 1.5 in (38 mm)
Stroke: 1.22 in (31 mm)

PERFORMANCE:

Idle Speed: 2,800 - 3,100 RPM
WOT (With Bar & Chain): 13,000 - 13,500 RPM
Power: 2.1 HP/1.6kW (8,500 RPM)

MT4000

ENGINE:

Displacement: 2.38 cu. in (39.0 cc)
Bore: 1.57 in (40 mm)
Stroke: 1.22 in (31 mm)

PERFORMANCE:

Idle Speed: 2,800 - 3,100 RPM
WOT (With Bar & Chain): 13,000 - 13,500 RPM
Power: 2.4 HP/1.75kW (8,500 RPM)

MT3600 and MT4000

FUEL AND OIL SYSTEMS:

Carburetor: Multi Position Diaphragm Carburetor
Fuel Tank Capacity: 10.8 oz. (320 ml)
Fuel Mix: See Operation-Fueling Section
Oil Tank Capacity: 7.4 oz. (220 ml)

IGNITION SYSTEM:

Spark Plug: NGK CMR6A
Spark Plug Gap: 0.02 in. (0.5 mm)

This spark ignition system complies with Canadian ICES-002.

Only for 152 model:

EPA / CEPA:

The Emission Compliance Period referred to on the Emissions Compliance Label indicates the number of operating hours for which the engine has been shown to meet Federal emission requirements.

Category:

A = 300 hours,
B = 125 hours,
C = 50 hours

CARB:

The Emission Compliance Period used on the CARB-Air Index Labels indicates the terms:

Extended = 300 hours,
Intermediate = 125 hours,
Moderate = 50 hours.



en **WARNING:** To ensure safe and correct operation of the chainsaw, this operator's manual should always be kept with or near the machine. Do not lend or rent your chainsaw without the operator's instruction manual.

fr **AVERTISSEMENT:** Afin de garantir un fonctionnement correct et en toute sécurité de la tronçonneuse, il est recommandé de toujours conserver le manuel de l'utilisateur à proximité de la machine. Ne prêtez ou ne louez jamais votre tronçonneuse sans fournir le présent manuel d'utilisation et d'entretien.

es **ADVERTENCIA:** Para garantizar el funcionamiento seguro y correcto de la motosierra, este manual del operador deberá conservarse siempre con la máquina o estar cerca de ella. No preste ni alquile la motosierra sin el manual de instrucciones del operador.

