

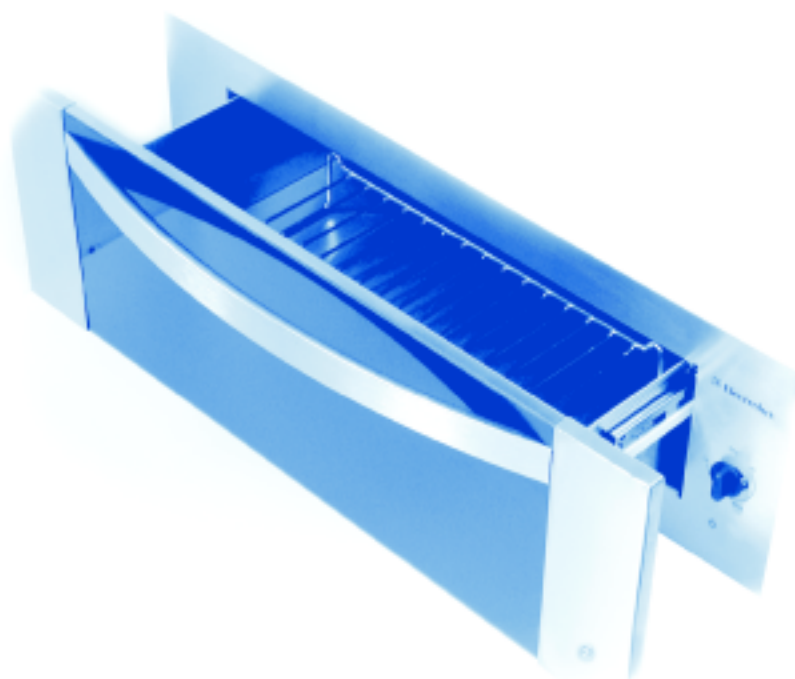

Use & Care Guide

Warm & Serve Drawer



 **Electrolux**

2 Finding Information

MAKE A RECORD FOR FUTURE USE

Brand _____

Purchase Date _____

Model Number _____

Serial Number _____

NOTE

The serial and model numbers are available on the serial plate located on the right side of the drawer frame.

QUESTIONS?

For toll-free telephone support in the U.S. and Canada:
1-877-4ELECTROLUX (1-877-435-3287)

For online support and internet product information:
www.electrolux.com

TABLE OF CONTENTS



Safety	4
Important Safety Instructions	4
Setting Control	7
Before Setting Warmer Drawer Control	7
Setting Warmer Drawer Control	7
General Care & Cleaning	9
Care & Cleaning Table	9
To Remove and Replace Warmer Drawer	10
Solutions to Common Problems	11
Drawer is Not Level	11
Cannot Move Appliance Easily	11
Warmer Drawer Does Not Operate	11
Warranty Information	12

4 Safety

IMPORTANT SAFETY INSTRUCTIONS

Please read all safety instructions before using your new Electrolux Warm & Serve Drawer.

WARNING

To reduce the risk of fire, electrical shock, or injury when using your Warm & Serve Drawer, follow basic precaution including the following:

- **Remove all tape and packaging wrap before using the appliance. Destroy the carton and plastic bags after unpacking the appliance.** Never allow children to play with packaging material.
- **Proper Installation. Be sure your appliance is properly installed and grounded by a qualified technician in accordance with the National Electrical Code ANSI/NFPA No. 70 - latest edition in the United States, or CSA C22.1, Part 1 in Canada, and local code requirements.** Install only per installation instructions provided in the literature package for this appliance.

Ask your dealer to recommend a qualified technician and an authorized repair service. Know how to disconnect the electrical power to the drawer at the circuit breaker or fuse box in case of an emergency.

- **User Servicing. Do not repair or replace any part of the appliance unless specifically recommended in the manuals.** All other servicing should be done only by a qualified technician to reduce the risk of personal injury and damage to the appliance.
- Never modify or alter the construction of the drawer by removing panels, wire covers, locking plates, or any other part of the product.

WARNING

- **ALL WARMER DRAWERS CAN TIP.**
- **INJURY TO PERSONS COULD RESULT.**
- **INSTALL ANTI-TIP DEVICE PACKED WITH WARMER DRAWER.**
- **SEE INSTALLATION INSTRUCTIONS.**

TO REDUCE THE RISK OF TIPPING OF THE WARMER DRAWER, THE DRAWER MUST BE SECURED BY PROPERLY INSTALLED ANTI-TIP LOCKING PLATES PROVIDED WITH THE DRAWER. TO CHECK IF THE LOCKING PLATES ARE INSTALLED PROPERLY, GRASP THE HANDLE OF THE OPEN DRAWER AND SEE IF THE DRAWER WILL SLIDE OUT OF THE OPENING OR TIP OUT. REFER TO THE INSTALLATION INSTRUCTIONS FOR PROPER LOCKING PLATE INSTALLATION.

WARNING

Do not use the warmer drawer for storage.

WARNING

Stepping, leaning or sitting on the door or drawer can result in serious injuries and may also cause damage to the warmer drawer. Do not allow children to climb or play around the drawer. An open drawer, when hot, may cause burns.

- **Storage in or on Appliance—Flammable materials should not be stored in the drawer.** This includes paper, plastic and cloth items, such as cookbooks, plasticware and towels, as well as flammable liquids. Do not store explosives, such as aerosol cans, on or near the warmer drawer. Flammable materials may explode and result in fire or property damage.
- **Do not leave children alone. Children should not be left alone or unattended in the area where an appliance is in use.** They should never be allowed to sit or stand on any part of the appliance.
- **DO NOT TOUCH INTERIOR SURFACES OF THE WARMER DRAWER.** Surfaces may be hot even though they are dark in color. During and after use, do not touch, or let clothing or other flammable materials touch these areas until they have had sufficient time to cool.
- **Wear Proper Apparel—Loose-fitting or hanging garments should never be worn while using the appliance.** Do not let clothing or other flammable materials contact hot surfaces.
- **Use Only Dry Potholders—Moist or damp potholders on hot surfaces may result in burns from steam.** Do not let the potholders touch hot heating elements. Do not use a towel or other bulky cloth instead of a potholder.
- **Do Not Heat Unopened Food Containers—Build-up of pressure may cause the container to burst and result in injury.**
- **IMPORTANT—Do not attempt to operate the warmer drawer during a power failure. If the power fails, always turn the control off.** If the drawer is not turned off and the power resumes, the drawer may begin to operate again. Food left unattended could spoil.

WARNING

Never use your appliance for warming or heating the room.

- **Protective Liners—**Do not use aluminum foil to line warmer drawer. Any other use of protective liners or aluminum foil may result in poor performance or damage to the appliance. Only use aluminum foil as recommended for baking if used as a cover placed on the food.
- **Glazed Cooking Utensils—**Only certain types of glass, glass/ceramic, ceramic, earthenware, or other glazed utensils are suitable for use without breaking due to the sudden change in temperature. Check the manufacturer's recommendations.
- **Use Care When Opening Warmer Drawer—**Stand to the side of the unit when opening the door of a hot drawer. Let hot air or steam escape before you remove or replace food in the warmer drawer.

6 Safety

- **Placement of Warmer Drawer Racks**—Always place rack in desired location while drawer is cool. If rack must be moved while hot, use extreme caution. Use potholders and grasp the rack with both hands to reposition. Do not let potholders contact the hot element or interior of the warmer drawer. Remove all utensils from the rack before removing rack.
- **Do Not Use Water on Grease Fires**—Smother the fire or flame or use dry chemical or foam-type extinguisher.

IMPORTANT INSTRUCTIONS FOR CLEANING YOUR WARM & SERVE DRAWER

- **Clean the drawer regularly to keep all parts free of grease that could catch fire.** Do not allow grease to accumulate. Greasy deposits could catch fire.
- **Kitchen cleaners/aerosols**—Always follow the manufacturer's recommended directions for use. Be aware that excess residue from cleaners and aerosols may ignite causing damage and/or injury.

IMPORTANT SAFETY NOTICE

The California Safe Drinking Water and Toxic Enforcement Act requires the Governor of California to publish a list of substances known to the state to cause cancer, birth defects or other reproductive harm, and requires businesses to warn customers of potential exposure to such substances.

NOTE

Save these important safety instructions for future reference.

BEFORE SETTING WARMER DRAWER CONTROL

Arranging Warmer Drawer Rack Positions

Set the warmer drawer rack in the vertical position as shown below.

The rack can be used in 2 ways:

- In the **upright position** to allow low profile food items to be placed both under and on top of the rack (for example, rolls or biscuits on top of the rack and a casserole dish under).
- In the **downward position** to allow you to place light weight food items and empty dishware (for example, rolls or pastries and dinner plates).

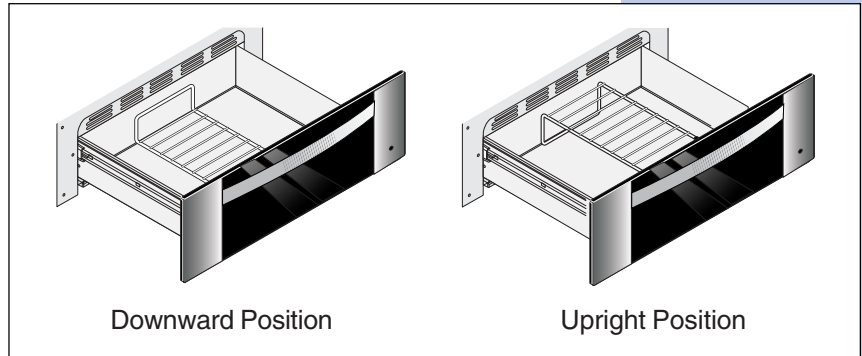

SETTING WARMER DRAWER CONTROL

Use the warmer drawer to keep hot foods hot such as: vegetables, gravies, meats, casseroles, biscuits and rolls, pastries and heated dinner plates.

The warmer drawer is equipped with a catch which may require extra force when opening and closing the drawer.

To Operate the Warmer Drawer

The purpose of the warmer drawer is to keep hot cooked foods at serving temperature. Always start with hot food. **It is not recommended to heat cold food in the warmer drawer.**

All food placed in the warmer drawer should be covered with a lid or aluminum foil to maintain moisture and softness. Do not cover crisp foods. **Do not use plastic wrap to cover food. Plastic may melt onto the drawer and be very difficult to clean.**

Use only dishware, utensils and cookware recommended for oven use in the warmer drawer.

CAUTION

Always use potholders or oven mitts when removing food from the warmer drawer as cookware and plates will be hot.

Indicator Light

The indicator light is located below the thermostat control knob. It turns on when the control is set, and stays on until the control is turned off. Make sure indicator light is off when removing food from drawer.

8 Setting Control

SETTING WARMER DRAWER CONTROL

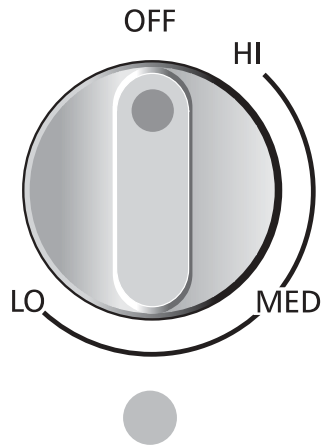

The knob shown is typical only.

To Set the Thermostat Control

The thermostat control knob is used to select the temperature of the warmer drawer. It is located at the right side of the warmer drawer in the open position. The temperatures are approximate, and are designated by HI, MED and LO. The control can be set to the three settings, or anywhere between.

1. To set the thermostat, push in and turn the knob to the desired setting.
2. For best results, preheat the drawer before adding food. An empty drawer will reach the LO setting in about 8 minutes, the MED setting in about 10 minutes, and the HI setting in about 12 minutes.
3. When done, turn the thermostat control to OFF.

Temperature Selection

Refer to the chart in the side column for recommended settings. If a particular food is not listed, start with the medium setting. If more crispness is desired, remove the lid or aluminum foil.

Most foods can be kept at serving temperatures by using the medium setting.



When a combination of foods are to be kept warm (for instance, a meat with 2 vegetables and rolls), use the high setting.

Refrain from opening the warmer drawer while in use to eliminate loss of heat from the drawer. Open only for adding or removing food.

To Warm Serving Bowls and Plates

Heat bowls and plates on the LO setting. Place empty dishes on the rack to raise them off drawer bottom. To further heat dishes or to heat fine china, check with the manufacturer for maximum heat tolerance.

To Set the Humidity Controller

The humidity controller is located on the inside of the warmer drawer and used to control humidity in the warmer drawer. The humidity control knob can be set at any position between Moist  (Figure 1) and Crispy  (Figure 2) position. To set the humidity controller, slightly unscrew the knob, slide the controller to the desired location and screw the knob (closed) in place.

Warmer Drawer Recommended Food Settings Chart

Food Item	Setting
Bacon	HI
Biscuits	MED
Casseroles	MED
Eggs	MED
Empty Dinner Plates	LO
Fish, Seafood	MED
Fried Foods	HI
Gravies, creams, sauces	MED
Ham	MED
Hamburger Patties	HI
Pancakes, Waffles	HI
Pastries	MED
Pies	MED
Pizza	HI
Pork Chops	HI
Potatoes (baked)	HI
Potatoes (mashed)	MED
Poultry	HI
Roasts (Beef, Pork, Lamb)	MED
Rolls, soft	LO
Rolls, hard	MED
Vegetables	MED

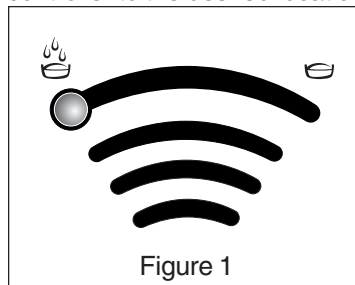

Figure 1

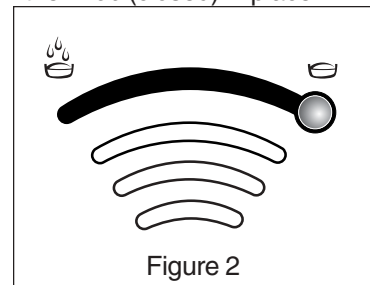
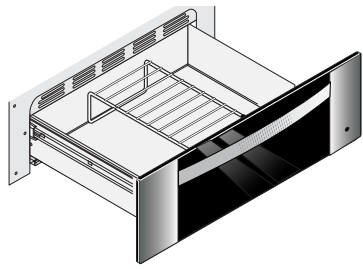

Figure 2

CARE & CLEANING TABLE

Cleaning Various Parts or Your Appliance

Before cleaning any part of the drawer, be sure control is turned OFF and the drawer is COOL. REMOVE SPILLOVERS AND HEAVY SOILING AS SOON AS POSSIBLE. REGULAR CLEANINGS WILL REDUCE THE NUMBER OF MAJOR CLEANINGS LATER.

Surfaces	How to Clean
Plastic Control Knobs	To remove control knob, turn to the OFF position; grasp firmly and pull straight off the shaft. Clean with a cloth soaked in soapy water. Rinse with a clean water and a dishcloth. To replace knob after cleaning, line up the flat sides of both the knob and the shaft; then push the knob into place. Note: Humidity controller knob can not be removed .
Stainless Steel Door & Drawer Body	Cleaners made especially for stainless steel are recommended. Always follow the manufacturer's instructions. Be sure to rinse the cleaners. DO NOT clean the door gasket. The door gasket is essential for a good seal. Care should be taken not to rub, damage or remove the gasket.
Porcelain Enamel Body Parts and Cavity	Gentle scouring with a soapy scouring pad will remove most spots. Rinse with a 1:1 solution of clear water and ammonia. <i>If necessary</i> , cover difficult spots with an ammonia-soaked paper towel for 30 to 40 minutes. Rinse with clean water and a damp cloth, and then scrub with a soap-filled scouring pad. Rinse and wipe dry with a clean cloth. Remove all cleaners or the porcelain may become damaged during future heating. DO NOT use spray oven cleaners.
Warmer Drawer Rack 	The rack may be removed for cleaning. If removed, clean by using a mild, abrasive cleaner following manufacturer's instructions. Rinse with clean water and dry.

10 General Care & Cleaning

TO REMOVE AND REPLACE WARMER DRAWER

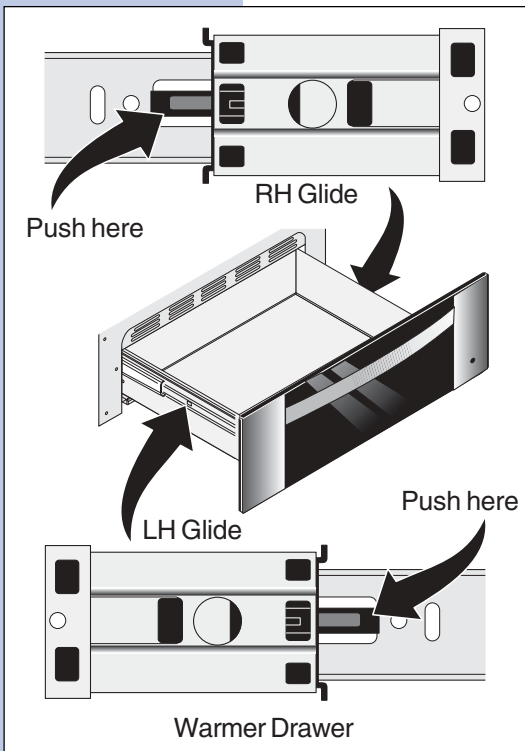

WARNING

Turn the warmer drawer control knob to OFF before removing the drawer. **DO NOT** touch the warmer drawer element. The element may still be hot enough to cause burns, even if it is dark in color.

To Remove Warmer Drawer:

1. Make sure the drawer is COOL. Open the drawer to the fully opened position.
2. Locate the latches on both sides of the warmer drawer. Push at the same time on both latches while pulling the drawer out.
3. To clean warmer drawer and drawer cavity, see the cleaning chart.

To Replace Warmer Drawer:

1. Align the glide latches on both sides of the drawer with the slots on the drawer.
2. Push the drawer back in until you heard two little clicks which will indicate that the drawer is well installed.



WARNING

Electrical Shock Hazard can occur and result in serious injury or death. Disconnect appliance from electric power before cleaning and servicing the warmer drawer.

IMPORTANT

Before calling for service, review this list. It may save you both time and expense. This list includes common experiences that are not the result of defective workmanship or material in your Warm & Serve Drawer.

DRAWER IS NOT LEVEL

- Poor installation. Place a level on the cutout bottom. Make sure bottom is level.
- Be sure cutout bottom is strong and stable enough to adequately support drawer (and wall oven, if applicable).

CANNOT MOVE APPLIANCE EASILY

- Appliance must be accessible for service.
- Cabinets not square or are built in too tightly. Contact builder or installer to make appliance accessible.

WARMER DRAWER DOES NOT OPERATE

- Make sure cord/plug is plugged tightly into outlet.
- Service wiring is not complete. Contact your dealer, installing agent or authorized servicer.
- Power outage. Check house lights to be sure. Call your local electric company for service.

12 Warranty Information

WARMER DRAWER WARRANTY

Your warmer drawer is protected by this warranty

In the **U.S.A.**, your appliance is warranted by Electrolux Home Products North America, a division of White Consolidated Industries, Inc. We authorize no person to change or add to any of our obligations under this warranty. Our obligations for service and parts under this warranty must be performed by us or an authorized Electrolux Home Products North America servicer. In **Canada**, your appliance is warranted by Electrolux Canada Corp.

	WARRANTY PERIOD	THROUGH OUR AUTHORIZED SERVICERS, WE WILL:	THE CONSUMER WILL BE RESPONSIBLE FOR:
FULL ONE-YEAR WARRANTY	One year from original purchase date	Pay all costs for repairing or replacing any parts of this appliance which prove to be defective in materials or workmanship.	Costs of service calls that are listed under NORMAL RESPONSIBILITIES OF THE CONSUMER. *
LIMITED WARRANTY (Applicable to the State of Alaska)	Time periods listed above.	All of the provisions of the full and limited warranties above and the exclusion listed below apply.	Costs of the technician's travel to the home and any costs for pick up and delivery of the appliance required because of service.

***NORMAL RESPONSIBILITIES OF THE CONSUMER**

This warranty applies only to products in ordinary household use, and the consumer is responsible for the items listed below:

1. Proper use of the appliance in accordance with instructions provided with the product.
2. Proper installation by an authorized servicer in accordance with instructions provided with the appliance and in accordance with all local plumbing, electrical and/or gas codes.
3. Proper connection to a grounded power supply of sufficient voltage, replacement of blown fuses, repair of loose connections or defects in house wiring.
4. Expenses for making the appliance accessible for servicing, such as removal of trim, cupboards, shelves, etc., which are not a part of the appliance when it was shipped from the factory.
5. Damages to finish after installation.
6. Replacement of light bulbs and/or fluorescent tubes (on models with these features).

EXCLUSIONS

This warranty does not cover the following:

1. CONSEQUENTIAL OR INCIDENTAL DAMAGES SUCH AS PROPERTY DAMAGE AND INCIDENTAL EXPENSES RESULTING FROM ANY BREACH OF THIS WRITTEN OR ANY IMPLIED WARRANTY.

NOTE: Some states do not allow the exclusion or limitation of incidental or consequential damages, so this limitation or exclusion may not apply to you.

2. Service calls which do not involve malfunction or defects in workmanship or material, or for appliances not in ordinary household use. The consumer shall pay for such service calls.
3. Damages caused by services performed by servicers other than Electrolux Home Products North America or its authorized servicers; use of parts other than genuine Electrolux Home Products parts; obtained from persons other than such servicers; or external causes such as abuse, misuse, inadequate power supply or acts of God.
4. Products with original serial numbers that have been removed or altered and cannot be readily determined.

IF YOU NEED SERVICE

Keep your bill of sale, delivery slip, or some other appropriate payment record. The date on the bill establishes the warranty period should service be required. If service is performed, it is in your best interest to obtain and keep all receipts. This written warranty gives you specific legal rights. You may also have other rights that vary from state to state. Service under this warranty must be obtained by contacting Electrolux Home Products:

USA
1•800•944•9044
 Electrolux Home Products
 North America
 P.O. Box 212378
 Augusta, GA 30917

Canada
1•866•294•9911
 Electrolux Home Products
 North America
 802, boul. L'Ange-Gardien
 L'Assomption, Québec
 J5W 1T6

This warranty only applies in the 50 states of the U.S.A., Puerto Rico, and Canada. Product features or specifications as described or illustrated are subject to change without notice. All warranties are made by Electrolux Home Products North America, a division of White Consolidated Industries, Inc. In **Canada**, your appliance is warranted by Electrolux Canada Corp.