



# Power Pruner™

## *Operator's Manual*

**MODEL: PPT-265S**

### **WARNING** **DANGER**



The muffler or catalytic muffler and surrounding cover may become extremely hot.

Always keep clear of exhaust and muffler area, otherwise serious personal injury may occur.



### **WARNING**



The engine exhaust from this product contains chemicals known to the State of California to cause cancer, birth defects or other reproductive harm.



### **WARNING**

Read rules for safe operation and instructions carefully. ECHO provides an Operator's Manual and a Safety Manual. Both must be read and understood for proper and safe operation.

## INTRODUCTION

Welcome to the ECHO family. This ECHO product was designed and manufactured to provide long life and on-the-job dependability. Read and understand this manual and the SAFETY MANUAL you found in the same package. You will find both easy to use and full of helpful operating tips and SAFETY messages.

### THE OPERATOR'S MANUAL

Read and understand this manual before operation. Keep it in a safe place for future reference. It contains specifications and information for operation, starting, stopping, maintenance, storage, and assembly specific to this product.

### THE SAFETY MANUAL

Read and understand this manual before operation. Keep it in a safe place for future reference. It explains possible hazards involved with the use of Power Pruner™ and what measures you should take to make their use safer.

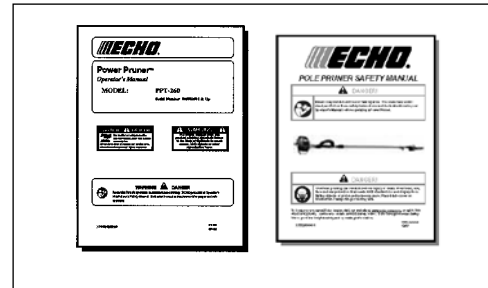

## TABLE OF CONTENTS

Introduction.....	2	Maintenance.....	21
- The Operator's Manual.....	2	- Skill Levels.....	21
- The Safety Manual.....	2	- Maintenance Intervals.....	21
Safety.....	3	- Air Filter.....	22
- Manual Safety Symbols and Important Information.....	3	- Fuel Filter.....	22
- International Symbols.....	3	- Spark Plug.....	23
- Personal Condition and Safety Equipment.....	4	- Cooling System Cleaning.....	23
- Kickback.....	6	- Exhaust System.....	24
- Equipment.....	7	- Carburetor Adjustment.....	26
Emission Control.....	8	- Guide Bar and Saw Chain Replacement.....	27
Description.....	8	- Filing Saw Chain.....	30
Contents.....	11	Troubleshooting.....	31
Assembly.....	11	Storage.....	32
- Drive Shaft/Power Head.....	11	Specifications.....	33
- Throttle Linkage and Ignition Leads.....	12	Servicing Information.....	36
- Cutting Attachment to Drive Shaft Installation.....	13	- Parts.....	36
- Saw Chain Tension Adjustment.....	14	- Service.....	36
Operation.....	15	- ECHO Consumer Product Support.....	36
- Fuel.....	15	- Warranty Card.....	36
- Lubricating the Guide Bar and Saw Chain.....	17	- Additional or Replacement Manuals.....	36
- Adjusting Automatic Oiler.....	17		
- Starting Cold Engine.....	18		
- Starting Warm Engine.....	19		
- Stopping Engine.....	20		
- Pruning Techniques.....	20		

Specifications, descriptions and illustrative material in this literature are as accurate as known at the time of publication, but are subject to change without notice. Illustrations may include optional equipment and accessories, and may not include all standard equipment.

## SAFETY MANUAL SAFETY SYMBOLS AND IMPORTANT INFORMATION

Throughout this manual and on the product itself, you will find safety alerts and helpful, informational messages preceded by symbols or key words. The following is an explanation of those symbols and key words and what they mean to you.

### **DANGER**

The safety alert symbol accompanied by the word “DANGER” calls attention to an act or condition which **WILL** lead to serious personal injury or death if not avoided.

### **WARNING**

The safety alert symbol accompanied by the word “WARNING” calls attention to an act or condition which **CAN** lead to serious personal injury or death if not avoided.

### **CAUTION**

The safety alert symbol accompanied by the word “CAUTION” calls attention to an act or condition which may lead to minor or moderate personal injury if not avoided.



### **CIRCLE AND SLASH SYMBOL**

This symbol means the specific action shown is prohibited. Ignoring these prohibitions can result in serious or fatal injury.

### **NOTE**











This enclosed message provides tips for use, care and maintenance of the unit.

### **IMPORTANT**

The enclosed message provides information necessary for the protection of the unit.

## INTERNATIONAL SYMBOLS

Symbol form/shape	Symbol description/application	Symbol form/shape	Symbol description/application
	Read and understand Operator's Manual.		Fuel and oil mixture
	Wear eyes, ears and head protection		Finger Severing
	Hot Surface		Wear hand protection. Use two handed.
	Safety/Alert		DO NOT smoke near fuel.
	Avoid all power lines. This unit is not insulated against electrical current.		Do not operate closer than 15 M (50 ft.) from electrical hazards.
	Keep bystanders at least 15 meters (50 feet) away.		Plan retreat path from falling objects.

Symbol form/shape	Symbol description/application	Symbol form/shape	Symbol description/application
	DO NOT allow flames or sparks near fuel.		Wear slip resistant foot wear.
	Emergency stop		Ignition ON/OFF
	Chain lubrication		Primer bulb
	Carburetor adjustment - Low speed mixture		Carburetor adjustment - High speed mixture
	Carburetor adjustment - Idle speed		
	Choke Control "Cold Start" Position (Choke Closed)		Choke Control "Run" Position (Choke Open)

## PERSONAL CONDITION AND SAFETY EQUIPMENT



### **WARNING**

Power Pruner™ users risk injury to themselves and others if the Power Pruner™ is used improperly and or safety precautions are not followed. Proper clothing and safety gear must be worn when operating a Power Pruner™.

### ***Physical Condition***

Your judgment and physical dexterity may not be good:

- if you are tired or sick,
- if you are taking medication,
- if you have taken alcohol or drugs.

Operate unit only if you are physically and mentally well.

### ***Eye Protection***

Wear eye protection that meets ANSI Z87.1 or CE requirements whenever you operate the unit

### ***Face and Head Protection***

When trimming overhead, always wear head protection meeting ANSI Z89.1 or CE requirements with a full face shield. Head protection with full face shield will help protect you from falling branches and debris.

### ***Hand Protection***

Wear no-slip, heavy duty work gloves to improve your grip on the unit handles. Gloves also reduce the transmission of machine vibration to your hands.

### ***Vibration and Cold***

It is believed that a condition called Raynaud's Phenomenon, which affects the fingers of certain individuals may be brought about by exposure to vibration and cold. Exposure to vibration and cold may cause tingling and burning sensations followed by loss of color and numbness in the fingers. The following precautions are strongly recommended because the minimum exposure which might trigger the ailment is unknown.

- Keep your body warm, especially the head, neck, feet, ankles, hands and wrists.
- Maintain good blood circulation by performing vigorous arm exercises during frequent work breaks and also by not smoking.
- Limit the hours of operation. Try to fill each day with jobs where operating the unit or other hand-held power equipment is not required.
- If you experience discomfort, redness, and swelling of the fingers followed by whitening and loss of feeling, consult your physician before further exposing yourself to cold and vibration.

### ***Hearing Protection***

ECHO recommends wearing hearing protection whenever unit is used.

### ***Proper Clothing***

Wear snug fitting, durable protective clothing; chain saw safety pants or chaps are recommended.

- Pants should have long legs, shirts with long sleeves.
- DO NOT WEAR SHORTS,
- DO NOT WEAR TIES, SCARVES, JEWELRY.

Wear sturdy protective safety shoes or boots with non-skid soles;

- DO NOT WEAR OPEN TOED SHOES,
- DO NOT OPERATE UNIT BAREFOOTED.

Keep long hair away from engine and air intake. Retain hair with cap or net.

### ***Hot Humid Weather***

Heavy protective clothing can increase operator fatigue, which may lead to heat stroke. Schedule heavy work for early morning or late afternoon hours when temperatures are cooler.



## **Repetitive Stress Injuries**

It is believed that overusing the muscles and tendons of the fingers, hands, arms and shoulders may cause soreness, swelling, numbness, weakness and extreme pain in those areas. Certain repetitive hand activities may put you at a high risk for developing a Repetitive Stress Injury (RSI). An extreme RSI condition is Carpal Tunnel Syndrome (CTS), which could occur when your wrist swells and squeezes a vital nerve that runs through the area. Some believe that prolonged exposure to vibration may contribute to CTS. CTS can cause severe pain for months or even years.

To reduce the risk of RSI/CTS, do the following:

- Avoid using your wrist in a bent, extended or twisted position. Instead try to maintain a straight wrist position. Also, when grasping, use your whole hand, not just the thumb and index finger.
- Take periodic breaks to minimize repetition and rest your hands.
- Reduce the speed and force with which you do the repetitive movement.
- Do exercises to strengthen the hand and arm muscles.
- Immediately stop using all power equipment and consult a doctor if you feel tingling, numbness or pain in the fingers, hands, wrists or arms. The sooner RSI/CTS is diagnosed, the more likely permanent nerve and muscle damage can be prevented.

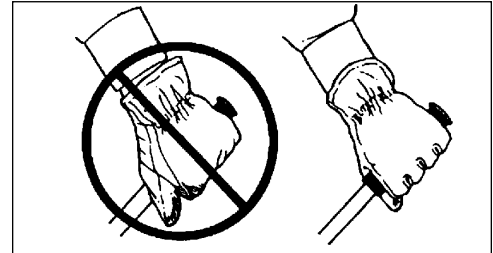

## **DANGER**

All over head electrical conductors and communications wires can have electricity flow with high voltages. This unit is not insulated against electrical current. Never touch wires directly or indirectly when pruning, otherwise serious injury or death may result.



## **WARNING**

Do not operate this product indoors or in inadequately ventilated areas. Engine exhaust contains poisonous emissions and can cause serious injury or death.

### **Read the Manuals**

- Provide all operators of this equipment with the Operator's Manual, and instructions for safe operation.

### **Clear the Work Area**

- Spectators and fellow workers must be warned, and children and animals prevented from coming nearer than 15 m (50 ft.) while the unit is in use.

### **Use Proper Clothing & Equipment**

- Always wear head protection with full face shield to help protect against falling branches and debris.

### **Keep A Firm Grip**

- Grip Power Pruner™ with both hands with thumbs and fingers encircling the handle, and shaft tube.

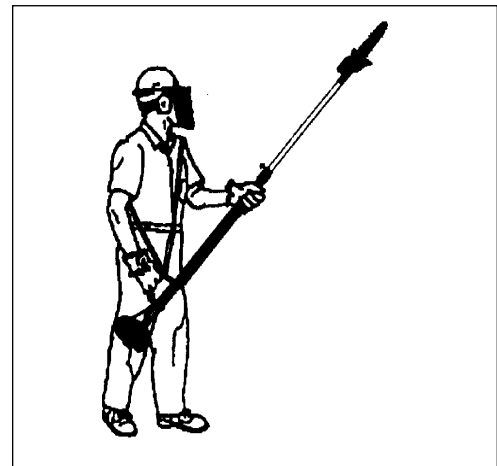

## Keep A Solid Stance

- Maintain footing and balance at all times. Do not stand on slippery, uneven or unstable surfaces. Do not work in odd positions or on ladders. Do not overreach.
- Operate the Power Pruner™ only from the ground or out of an approved bucket lift.
- Always evaluate the branches to be pruned for hazards such as loose dead branches which may fall and strike the operator or helpers. Remove hazards before pruning.
- Plan retreat path from falling objects.
- Cut branches bounce when striking ground.
- Check that shoulder harness is adjusted for safe, comfortable operation. See picture at right for proper adjustment.
- Turn the Power Pruner™ off when moving from tree to tree.
- Avoid any contact with saw chain.

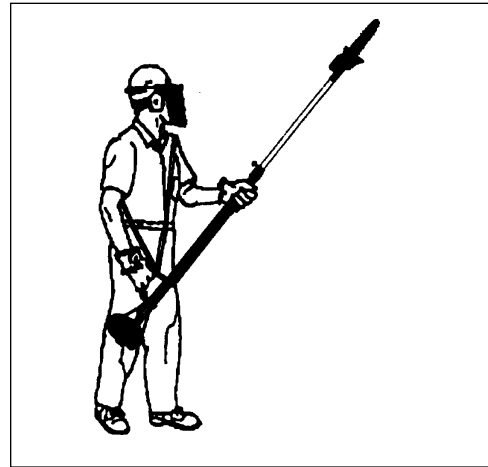

## Avoid Hot Surfaces

- Keep exhaust area clear of flammable debris. Avoid contact during and immediately after operation.

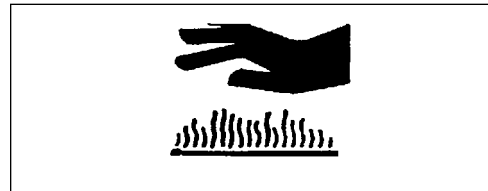

## KICKBACK



### WARNING

Kickback can lead to dangerous loss of control of the Power Pruner™ and result in serious injury to the operator or any one standing close by. Hold the Power Pruner™ firmly with both hands with thumbs and fingers encircling the front and rear handles. Be aware of the down and outward path the pruner will take after the cut is made.

Kickback may occur when the moving saw chain at the nose or tip of the guide bar touches an object, or when the wood closes in and pinches the saw chain in the cut. In some cases this may cause a lightning-fast reverse action, kicking the guide bar and saw chain up and back or down and back towards the operator. Either of these reactions may cause the operator to lose control of the Power Pruner™ which could result in serious personal injury.

With a basic understanding of kickback, you can reduce or eliminate the element of surprise which contributes to accidents.

Avoid contact of the guide bar tip with any object while the saw chain is moving.

Cut only wood. Avoid striking concrete, metal, wire, or other obstructions which could cause kickback or damage to the saw chain.

If the saw chain does strike a foreign object, immediately stop the engine, inspect and repair the Power Pruner™ if necessary.

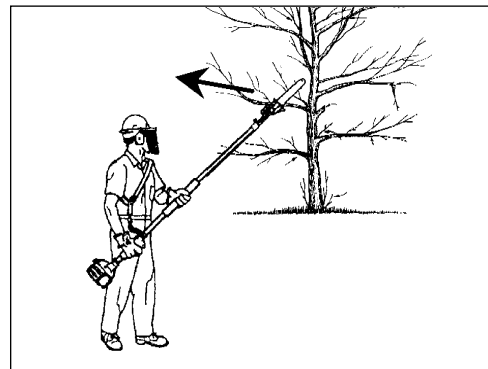

## EQUIPMENT



### WARNING

Serious injury may result from the use of non approved guide bar and saw chain combinations. ECHO, INC. will not be responsible for the failure of cutting devices or accessories which have not been tested and approved by ECHO for use with this unit. Read and comply with all safety instructions listed in this manual.

- Check unit for loose/missing nuts, bolts, and screws. Tighten and/or replace as needed.

### *Guide Bar and Saw Chain*

- Check that the cutting attachment, guide bar, and saw chain is firmly attached and in safe operating condition.
- Use only one Echo-approved extension on the pruner.
- Do not hit rocks, stones, tree stumps, and other foreign objects with the saw chain.
- Do not cut into the ground with the saw chain.
- If cutting attachment end strikes an obstruction, stop engine immediately and inspect saw chain for damage.
- Do not operate with a dull, fractured, or discolored saw chain.
- Remove all foreign objects from work area.
- Always cover the guide bar and saw chain with guide bar cover during transportation and for storage.



### WARNING

Moving parts can amputate fingers or cause severe injuries. Keep hands, clothing and loose objects away from all openings.

- **ALWAYS** stop engine, disconnect spark plug, and make sure all moving parts have come to a complete stop before removing obstructions, clearing debris, or servicing unit.
- **DO NOT** start or operate unit unless all guards and protective covers are properly assembled to unit.
- **NEVER** reach into any opening while the engine is running. Moving parts may not be visible through openings.



### WARNING

Check fuel system for leaks due to fuel tank damage, especially if the unit is dropped. If damage or leaks are found, do not use unit, otherwise serious personal injury or property damage may occur. Have unit repaired by an authorized servicing dealer before using.

## EMISSION CONTROL

### *EPA Phase 2 / C.A.R.B. TIER III*

The emission control system for the engine is EM/TWC (Engine Modification and 3-way Catalyst) and for the fuel tank the Control System is EVAP (Evaporative Emissions). Evaporative emission may be applicable to California models only.

#### IMPORTANT ENGINE INFORMATION

ENGINE FAMILY: 8EHXS.0254KG DISPLACEMENT: 25.4 cc  
EMISSION COMPLIANCE PERIOD : 300 HRS.

THIS ENGINE MEETS U.S. EPA PH2 EXH AND 2007 AND LATER CALIFORNIA EXH AND EVAP EMISSION REGULATIONS FOR S.O.R.E. REFER TO OWNER'S MANUAL FOR MAINTENANCE SPECIFICATIONS AND ADJUSTMENTS.



**KIORTZ CORP.**

An Emission Control Label is located on the engine. (This is an EXAMPLE ONLY, information on label varies by engine FAMILY).

#### PRODUCT EMISSION DURABILITY

The 300 hour emission durability compliance period is the time span selected by the manufacturer certifying the engine emissions output meets applicable emissions regulations, provided that approved maintenance procedures are followed as listed in the Maintenance Section of this manual.

## DESCRIPTION

Locate this safety decal on your unit. Make sure the decals are legible and that you understand and follow the instructions on them. If a decal cannot be read, a new one can be ordered from your ECHO dealer. See PARTS ORDERING instructions for specific information.

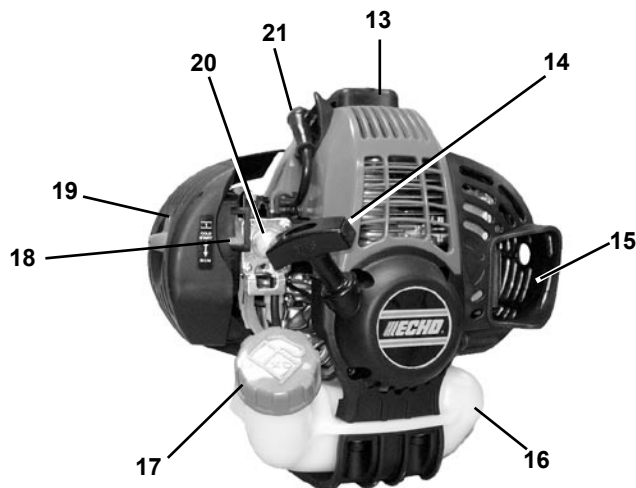

### *Hot Decal (near muffler)*

P/N X505002310

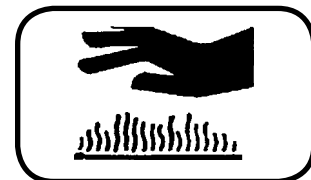



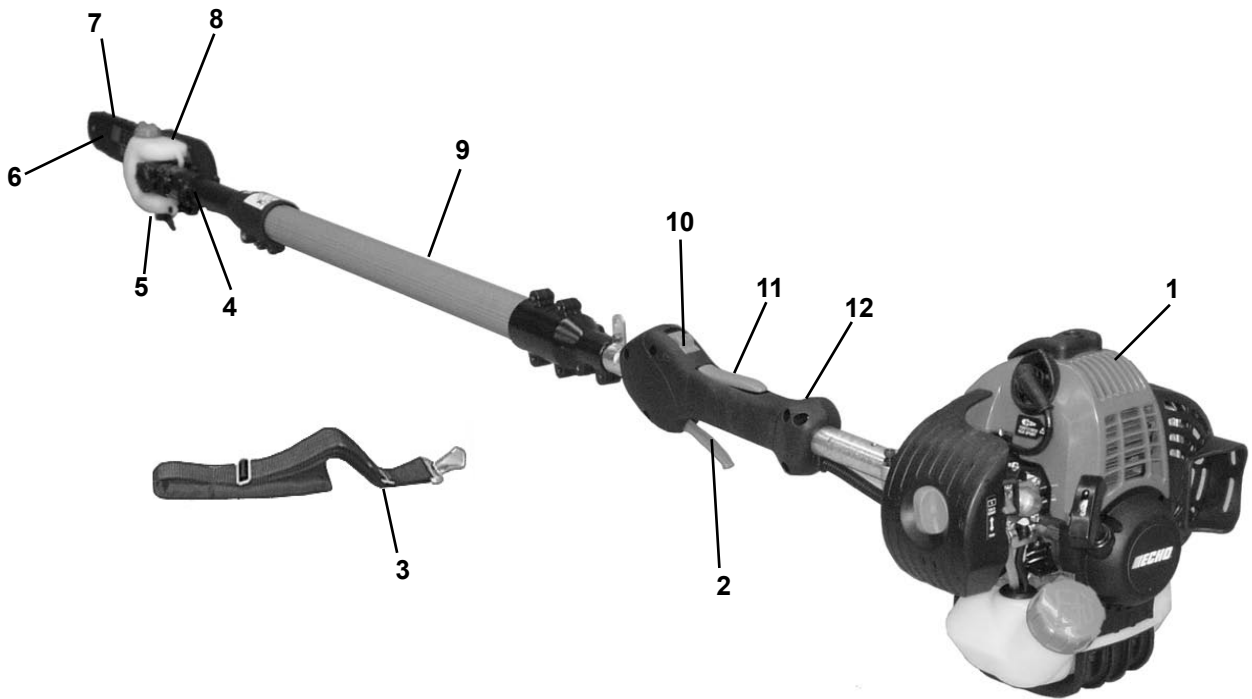

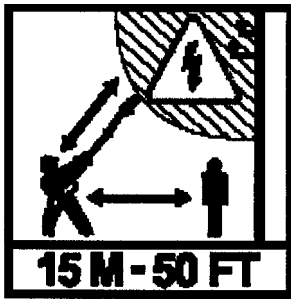

P/N X505002371

P/N X505002361



1. **POWER HEAD** - Includes the Engine, Clutch, Fuel System, Ignition System and Starter.
2. **THROTTLE TRIGGER** - Spring loaded to return to idle when released. During acceleration press trigger gradually for best operating technique.
3. **SHOULDER HARNESS** - An adjustable strap that suspends the unit from the operator.
4. **CUTTING ATTACHMENT** - Sealed, gear ratio is 1.5:1 reduction.
5. **CUTTING SHOE** - Used to capture and stabilize branch while cutting. Place cutting shoe against branch, accelerate and lower saw chain into branch.
6. **GUIDE BAR** - 305 mm (12 in.) guide bar w/chain tensioner.
7. **SAW CHAIN** - 91, 9.53 mm (3/8 in.) pitch, 0.050 gauge low profile Oregon® saw chain. Runs approximately 609.6 m/min. (2000 ft/min) at full throttle.
8. **AUTOMATIC OILER ASSEMBLY** - Self oiling. Use high quality, low viscosity, non detergent bar and chain oil.
9. **LOWER SHAFT TUBE** - Durable fiberglass mesh housing.
10. **STOP SWITCH** - Mounted on top of handle assembly. Move switch forward to run, back to stop.
11. **THROTTLE TRIGGER LOCKOUT** - This lever must be depressed before throttle trigger can be operated.
12. **REAR HANDLE ASSEMBLY** - Sturdy handle for right hand placement. Includes stop switch and throttle trigger.
13. **TOP GUARD** - Protects arm from hot engine.
14. **RECOIL STARTER** - Pull recoil handle slowly until starter engages, then quickly and firmly. When engine starts return handle slowly. **DO NOT** let handle snap back or damage will occur.
15. **SPARK ARRESTOR - CATALYTIC MUFFLER / MUFFLER** -The muffler or catalytic muffler controls exhaust noise and emission. The spark arrestor screen prevents hot, glowing particles of carbon from leaving the muffler. Keep exhaust area clear of flammable debris.
16. **FUEL TANK** - Contains fuel and fuel filter.
17. **FUEL TANK CAP** - Covers and seals fuel tank opening.
18. **CHOKE** - Located above air cleaner housing. Move lever to starting position () (close choke) and back to run position () (open choke).
19. **AIR CLEANER ASSEMBLY** - Contains replaceable air filter element.
20. **PURGE BULB** - Pumping purge bulb before starting engine draws fresh fuel from the fuel tank, purging air from the carburetor. Pump purge bulb until fuel is visible and flows freely in the clear fuel tank return line. Pump purge bulb an additional 4 or 5 times.
21. **SPARK PLUG** - Provides spark to ignite fuel mixture.
22. **GUIDE BAR COVER** - Used to cover guide bar and saw chain during transport and storage. Remove guide bar cover before using unit.

## CONTENTS

Due to packaging restriction the ECHO product you have purchased requires some assembly. After opening the carton, check for damage. Immediately notify your retailer or ECHO Dealer of damaged or missing parts. Use the contents list to check for missing parts.

- \_\_\_ Power Head
- \_\_\_ Drive Shaft Assembly
- \_\_\_ Cutting Attachment W/ Guide Bar and Saw Chain
- \_\_\_ Operator's Manual
- \_\_\_ Safety Manual
- \_\_\_ Warranty Registration Card
- \_\_\_ Warranty Statement
- \_\_\_ T-Wrench (combination screwdriver/spark plug socket)
- \_\_\_ 4 mm hex wrench
- \_\_\_ Safety Glasses
- \_\_\_ Echo Power Blend X™ 2-stroke oil sample
- \_\_\_ Shoulder Harness
- \_\_\_ Guide Bar Cover

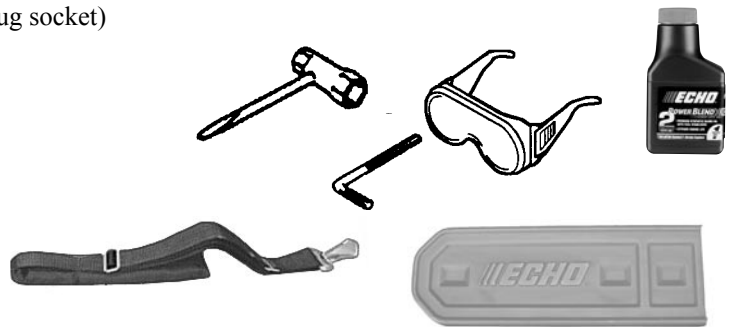
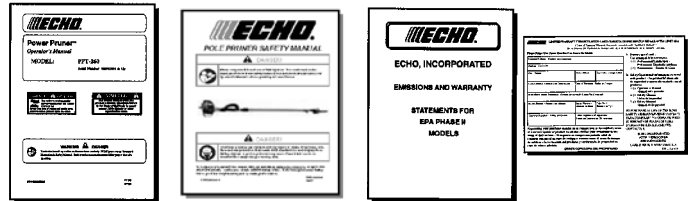

## ASSEMBLY

**Tools Required:** 10x19mm (13/32x3/4in) T-wrench, 4 mm Hex Wrench

**Parts Required:** Power Head, Drive Shaft Assembly, Cutting Attachment

### DRIVE SHAFT / POWER HEAD

1. Remove protective cap from drive shaft end.
2. Loosen two (2) clamping screws (A) and remove locating screw (B).
3. Pull flexible drive shaft coupler (C) 2-3 in. out of drive shaft assembly.

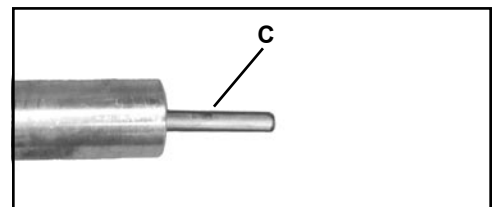
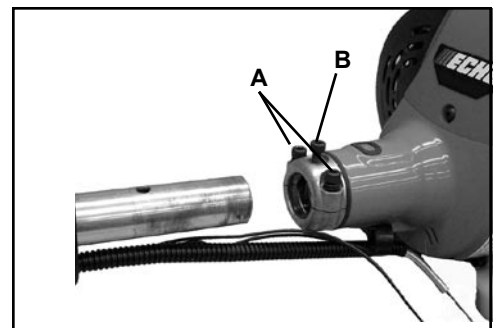
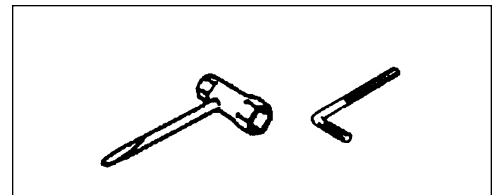

- Align flexible drive shaft coupler with engine socket and slide together until locating hole in shaft is visible through locating hole in engine housing.
- Install locating screw (B) and tighten clamping bolts (A).

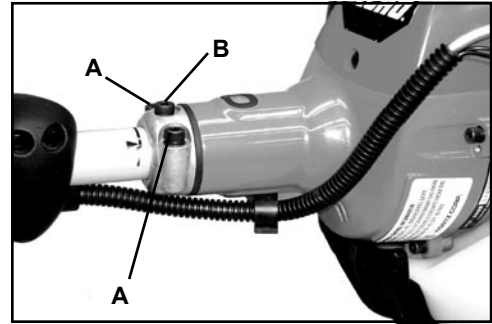

## THROTTLE LINKAGE AND IGNITION LEADS

- Install throttle linkage cable into fan cover clip (A).
- Close choke and remove air filter cover.
- Place throttle linkage (B) through adjustment fixture (C) and install wire end into large carburetor throttle swivel hole (D). Check throttle for freedom of movement and that wide open throttle / low idle extremes are adjusted properly. The throttle linkage must be adjusted by moving the adjustment fixture (C). Consult with your Echo Dealer for correct adjustment procedure.
- Connect 2 ignition stop leads (E, F) from throttle cable tubing to 2 ignition leads (E, F) on engine.

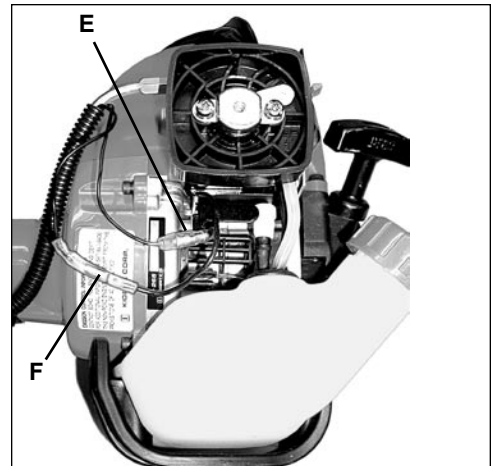
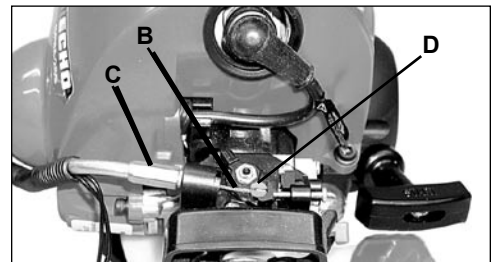
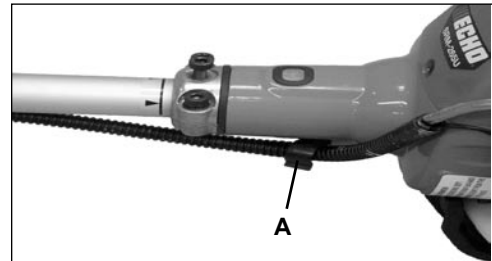

### CAUTION:

Assure ignition terminals are completely covered by clear plastic sleeves.

- Secure ignition leads against engine housing with clip (G).
- Install air filter and cover.

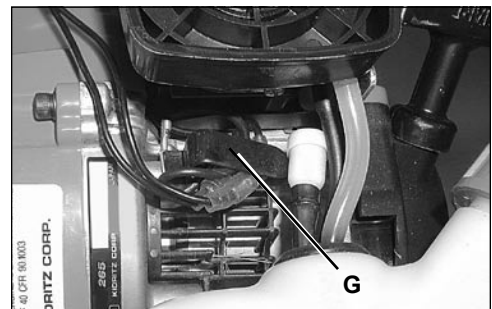

## CUTTING ATTACHMENT TO DRIVE SHAFT INSTALLATION



### WARNING

Saw Chain is sharp! Always wear gloves when handling assembly, otherwise serious personal injury may result.

1. Loosen the two (2) screws (C) and locator screw (D) on cutting attachment.
2. Loosen clamp knob (E) turning counter clockwise.
3. Pull upper tube (F) out of fiberglass lower tube 127-152 mm (5-6 in.), then slide (F) back into fiberglass lower tube exposing inner drive shaft (G). Align and join star shaped drive end of inner drive shaft (G) with cutting attachment shaft (H).
4. Align ridges (J) on upper tube with seams in cutting attachment.
5. Slide together aligning locator screw (D) in cutting attachment with locating hole (I) in upper tube.
6. Tighten locator screw (D). Tighten two (2) cutting attachment screws (C).
7. Extend upper tube to desired length. Tighten clamp knob (E) turning clockwise.

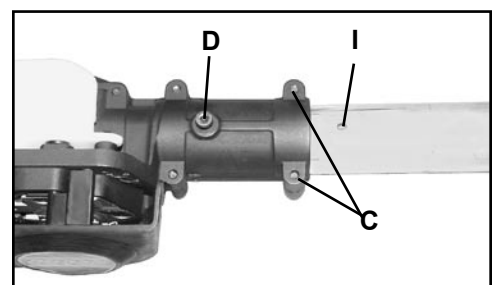
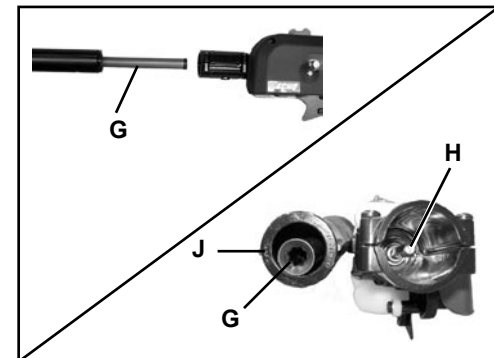
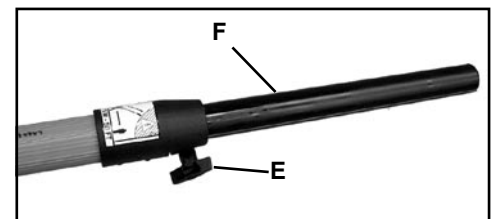
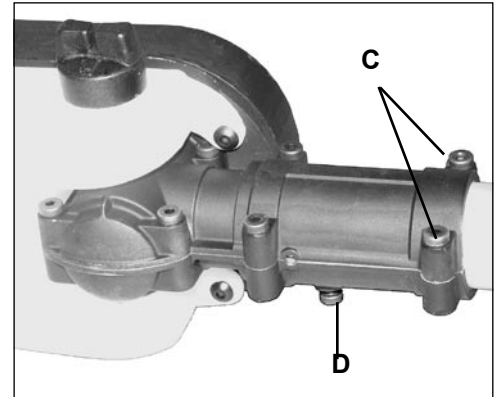

## SAW CHAIN TENSION ADJUSTMENT



### WARNING

Always disconnect spark plug wire before servicing cutting attachment. Wear gloves when handling saw chain, otherwise serious personal injury may result.

### To Adjust Saw Chain Tension

1. Move stop switch to STOP position.
2. Disconnect spark plug lead.
3. Loosen two gearcase cover nuts (A) until finger tight.
4. Hold the bar nose up, and turn the adjuster screw (B) clockwise until the chain fits snugly against the underside of the bar, as shown. Cold Chain Only - turn adjuster screw CW an additional 1/8 - 1/4 turn.
5. Tighten both gearcase cover nuts with nose held up. Tighten rear nut first.
6. Pull the chain around the guide bar by hand. Reduce the chain tension if you feel tight spots.
7. When chain is properly tensioned, tighten gear case cover nuts securely.

### IMPORTANT

Tighten gearcase cover nuts to 8 - 9 N•m (71 - 80 in. lbs.) DO NOT over-tighten nuts. Damage may result.

8. Keep chain properly tensioned at all times.

### NOTE

All chains require frequent adjustment.

9. Connect spark plug lead.

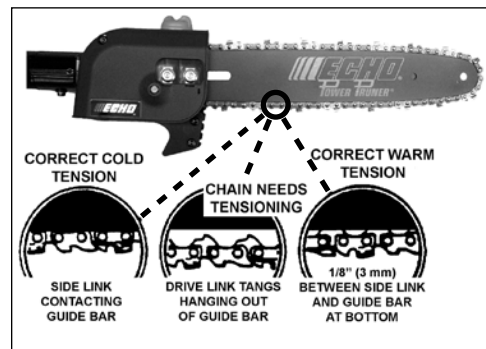
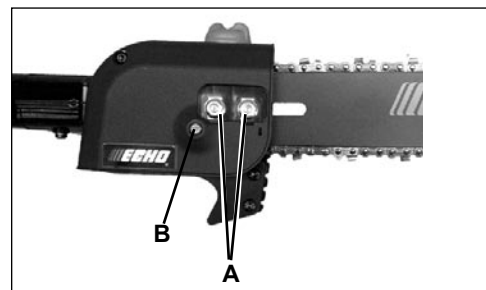

## OPERATION



### WARNING

Moving parts can amputate fingers or cause severe injuries. Keep hands, clothing and loose objects away from all openings. Always stop engine, disconnect spark plug, and make sure all moving parts have come to a complete stop before removing obstructions, clearing debris, or servicing unit.

**NOTICE:** Use of unmixed, improperly mixed, or fuel older than 90 days, (stale fuel), may cause hard starting, poor performance, or severe engine damage and void the product warranty. Read and follow instructions in the Storage section of this manual.

## FUEL



### WARNING

Alternative fuels, such as E-20 (20% ethanol), E-85 (85% ethanol) or any fuels not meeting ECHO requirements are **NOT** approved for use in ECHO 2-stroke gasoline engines. Use of alternative fuels may cause performance problems, loss of power, overheating, fuel vapor lock, and unintended machine operation, including, but not limited to, improper clutch engagement. Alternative fuels may also cause premature deterioration of fuel lines, gaskets, carburetors and other engine components.

### *Fuel Requirements*

**Gasoline** - Use 89 Octane [R+M/2] (mid grade or higher) gasoline known to be good quality. Gasoline may contain up to 10% Ethanol (grain alcohol) or 15% MTBE (methyl tertiary-butyl ether). Gasoline containing methanol (wood alcohol) is **NOT** approved.

**Two Stroke Oil** - A two-stroke engine oil meeting ISO-L-EGD (ISO/CD 13738) and J.A.S.O. FC/FD Standards must be used. Echo brand premium Power Blend X™ Universal 2-Stroke Oil meets these standards. Engine problems due to inadequate lubrication caused by failure to use an (ISO/CD 13738) and J.A.S.O. FC/FDcertified oil, such as Echo premium Power Blend X™, will void the two-stroke engine warranty. (Emission related parts only are covered for two years, regardless of two-stroke oil used, per the statement listed in the Emission Defect Warranty Explanation.)

### IMPORTANT

Echo premium Power Blend X™ Universal 2-Stroke Oil may be mixed at 50:1 ratio for application in all Echo engines sold in the past regardless of ratio specified in those manuals.

## *Handling Fuel*



### DANGER

Fuel is VERY flammable. Use extreme care when mixing, storing or handling or serious personal injury may result.

- Use an approved fuel container.
- DO NOT smoke near fuel.
- DO NOT allow flames or sparks near fuel.
- Fuel tanks/cans may be under pressure. Always loosen fuel caps slowly allowing pressure to equalize.
- NEVER refuel a unit when the engine is HOT or RUNNING!
- DO NOT fill fuel tanks indoors. ALWAYS fill fuel tanks outdoors over bare ground.
- DO NOT overfill fuel tank. Wipe up spills immediately.
- Securely tighten fuel tank cap and close fuel container after refueling.
- Inspect for fuel leakage. If fuel leakage is found, do not start or operate unit until leakage is repaired.
- Move at least 3m (10 ft.) from refueling location before starting the engine.

### Mixing Instructions

1. Fill an approved fuel container with half of the required amount of gasoline.
2. Add the proper amount of 2-stroke oil to gasoline.
3. Close container and shake to mix oil with gasoline.
4. Add remaining gasoline, close fuel container, and remix.

Fuel to Oil Mix - 50:1 Ratio			
U.S.		METRIC	
GAS	OIL	GAS	OIL
Gallons	Fl. oz.	Liter	cc.
1	2.6	4	80
2	5.2	8	160
5	13	20	400

#### **IMPORTANT**

Spilled fuel is a leading cause of hydrocarbon emissions. Some states may require the use of automatic fuel shut-off containers to reduce fuel spillage.

#### **After use**

- DO NOT store a unit with fuel in its tank. Leaks can occur. Return unused fuel to an approved fuel storage container.

**Storage** - Fuel storage laws vary by locality. Contact your local government for the laws affecting your area. As a precaution, store fuel in an approved, airtight container. Store in a well-ventilated, unoccupied building, away from sparks and flames.

#### **IMPORTANT**

Stored fuel ages. Do not mix more fuel than you expect to use in thirty (30) days, ninety (90) days when a fuel stabilizer is added.

#### **IMPORTANT**

Stored two-stroke fuel may separate. ALWAYS shake fuel container thoroughly before each use.



## LUBRICATING THE GUIDE BAR AND SAW CHAIN

### *Automatic Oiling System*

1. Wipe debris from around oil fill cap.
2. Remove oil fill cap and fill reservoir with a quality, low viscosity guide bar and saw chain oil.

#### **NOTE**

The discharge volume of the automatic oiler is preset to deliver 3 to 4 cc/min. at normal operating RPM. During heavy or dry cutting conditions the oil discharge volume may be adjusted to assure adequate lubrication. Refill the oil reservoir with each tank of fuel.

#### **IMPORTANT**

To prevent plastic deterioration, do not use synthetic or silicone based oil.



## ADJUSTING AUTOMATIC OILER

*Tools required:* Screwdriver

1. From bottom of gear case, turn adjustment screw (A) clockwise to decrease oil volume - counter clockwise to increase oil volume.

#### **NOTE**

Very little visible oil on the saw chain will provide sufficient lubrication.

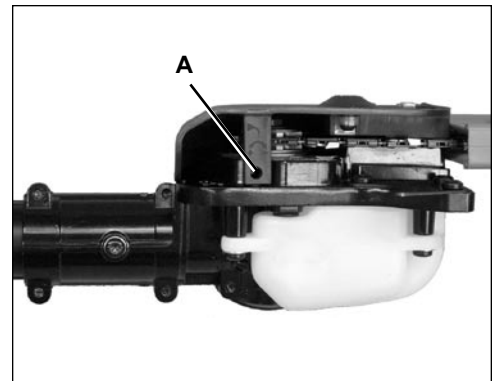

## STARTING COLD ENGINE



### WARNING

The attachment will operate immediately when the engine starts and could result in loss of control and possible serious injury. Keep movable parts of the attachment off the ground and away from objects that could become entangled or thrown.

- 1. Stop Switch**  
Move stop switch button (A) forward away from the STOP position.
- 2. Choke**  
Move choke (B) to “Cold Start” (I ←) Position.
- 3. Purge Bulb**  
Pump purge bulb (C) until fuel is visible and flows freely in the clear fuel tank return line. Pump bulb an additional 4 or 5 times.
- 4. Recoil Starter**  
Lay the unit on a flat, area and keep movable attachment parts clear of all obstacles. Firmly grasp right hand grip and throttle trigger lockout with left hand and fully depress throttle trigger to wide open position. Rapidly pull recoil starter handle/rope (D) until engine fires (or maximum five [5] pulls).
- 5. Choke**  
After engine fires (or five [5] pulls), move choke lever back to “Run” (I ↓) position. Hold throttle trigger and throttle trigger lockout fully depressed and pull recoil starter handle/rope until engine starts and runs. Release throttle trigger and allow unit to warm up at idle for several minutes.

### NOTE

If engine does not start with choke in “Run” position after 5 pulls, repeat instructions 2 - 5.

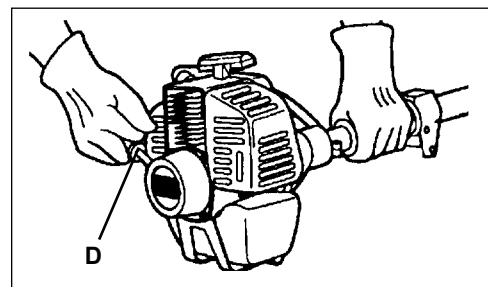
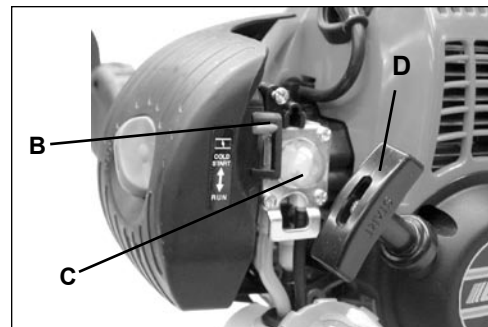
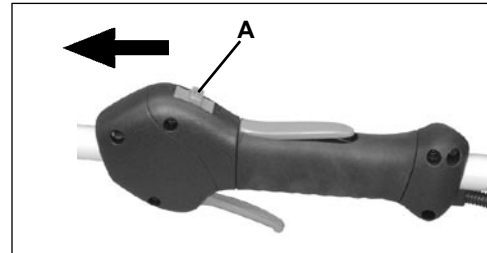

- 6. After engine warms up, gradually depress throttle trigger to increase engine RPM to operating speed.**

## STARTING WARM ENGINE

The starting procedure is the same as Cold Start except DO NOT close the choke, and do not depress throttle trigger to wide open position.



### WARNING

The attachment should not move at idle, otherwise serious personal injury may result.

### NOTE

If attachment moves, readjust carburetor according to “Carburetor Adjustment” instructions in this manual or see your ECHO Dealer.

1. *Stop Switch.*  
Move Stop Switch button (A) forward away from the STOP position.
2. *Purge Bulb*  
Pump purge bulb (C) until fuel is visible and flows freely in the clear fuel tank return line. Pump bulb an additional 4 or 5 times.
3. *Recoil Starter.*  
Lay the unit on a flat, clear area and firmly grasp right hand grip with left hand. Do not depress throttle trigger. Pull the recoil starter handle (D) until the engine fires.

### NOTE

If engine does not start after 5 pulls, use Cold Start Procedure.

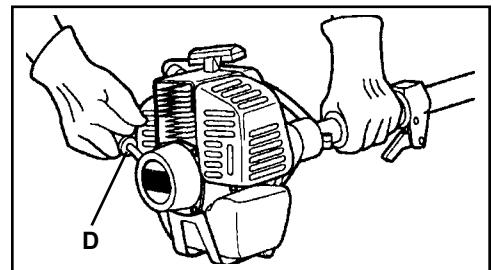
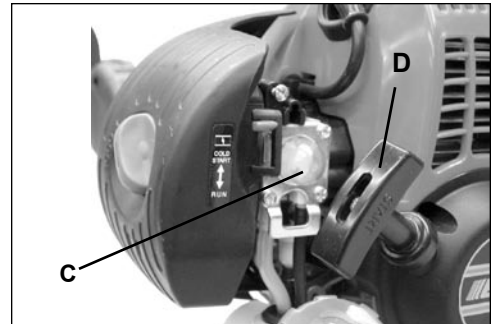
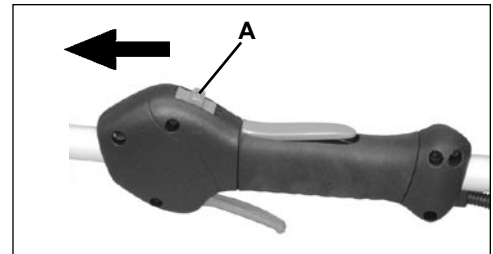

## STOPPING ENGINE

1. *Throttle.*  
Release throttle trigger, and allow engine to return to idle before stopping engine.
2. *Stop Switch.*  
Move stop switch button (A) backward to STOP position.

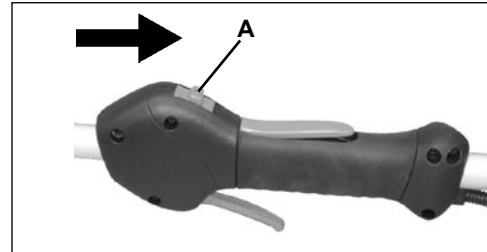

### WARNING

If engine does not stop when stop switch is moved to STOP position, close choke - COLD START position - to stall engine. Have your ECHO dealer repair stop switch before using pruner again.

## PRUNING TECHNIQUES



### WARNING

Engine exhaust IS HOT, and contains Carbon Monoxide (CO), a poison gas. Breathing CO can cause unconsciousness, serious injury, or death. Exhaust can cause serious burns. ALWAYS blow exhaust away from your face and body.

The Power Pruner™ is designed for light to medium trimming of limbs and branches up to 203 mm (8 in.) in diameter. Follow these tips for successful operation.

- Plan cut carefully. Check direction branch will fall.
- Plan retreat path from falling branch. Cut branches bounce when striking ground.
- Long branches should be removed in several pieces.
- Do not stand directly beneath branch being cut.
- When ready to cut:  
Hold "cutting shoe" against branch. This will prevent whipping of the branch. DO NOT use back and forth sawing action.
- Look out for branch immediately behind the branch being cut. If saw chain hits rear branch damage to saw chain may occur.
- Accelerate to full throttle.
- Apply cutting pressure.
- Ease cutting pressure when nearing end of cut to maintain control.
- When pruning a limb 102 mm (4 in.) diameter or larger cut as follows:
  1. Under cut 1/4 limb diameter near tree trunk.
  2. Finish top cut slightly farther out on limb.
  3. Flush cut stub at trunk.
- DO NOT use for felling or bucking.

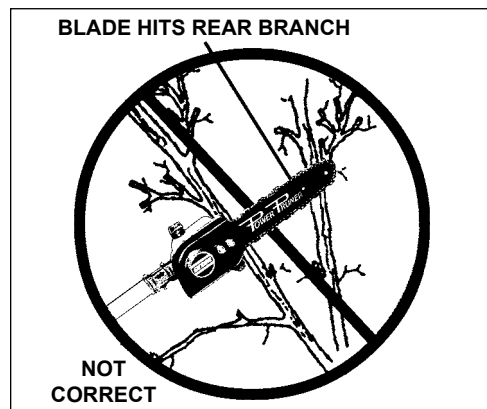
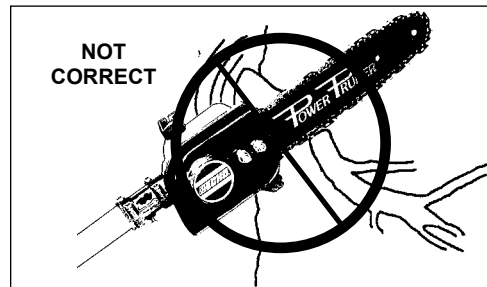
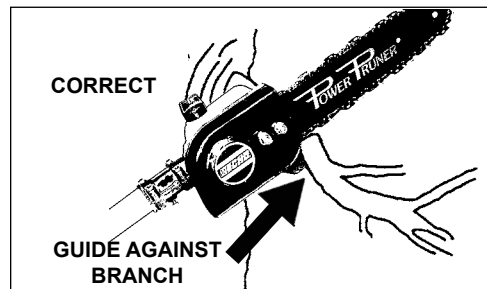

## MAINTENANCE



### WARNING

Moving parts can amputate fingers or cause severe injuries. Keep hands, clothing and loose objects away from all openings. Always stop engine, disconnect spark plug, and make sure all moving parts have come to a complete stop before removing obstructions, clearing debris, or servicing unit.

Your ECHO Power Pruner™ is designed to provide many hours of trouble free service. Regular scheduled maintenance will help your pruner achieve that goal. If you are unsure or are not equipped with the necessary tools, you may want to take your unit to an ECHO Service Dealer for maintenance. To help you decide whether you want to DO-IT-YOUR-SELF or have the ECHO Dealer do it, each maintenance task has been graded. If the task is not listed see your ECHO Dealer for repairs.

### SKILL LEVEL

- Level 1 = Easy to do. Common tools may be required.
- Level 2 = Moderate difficulty. Some specialized tools may be required.

ECHO offers **REPOWER™** Maintenance Kits and Parts to make your maintenance job easier.

### MAINTENANCE INTERVALS

COMPONENT / SYSTEM	MAINTENANCE PROCEDURE	REQ'D SKILL LEVEL	DAILY OR BEFORE USE	EVERY REFUEL	3 MONTHS OR 90 HOURS	YEARLY 600 HOURS
Air Filter	Inspect/Clean	1	I / C *		R *	
Choke Shutter	Inspect/Clean	1	I / C			
Fuel Filter	Inspect/Replace	1			I *	I / R *
Fuel Cap Gasket	Inspect/Replace	1			I *	R
Fuel System, leaks	Inspect/Replace	1	I (2) *	I (2) *		R
Spark Plug	Inspect/Clean/Replace	1			I/C/R *	
Cooling System	Inspect/Clean	2	I / C			
Muffler Spark Arrestor	Inspect/Clean/Replace	2			I/C/R *	
Cylinder Exhaust Port	Inspect/Clean/Decarbon	2			I / C	
Drive Shaft (Flex Cable Models)	Inspect/Grease	2			I (1)	
Guide Bar / Sprocket Nose	Inspect/Clean/Lubricate	2	I / C *	I		
Saw Chain	Inspect/Sharpen/Replace/Tension	2	I *	I *		
Recoil Starter Rope	Inspect/Clean	1	I / C *			
Screws/Nuts/Bolts	Inspect/Tighten/Replace	1	I *			

**MAINTENANCE PROCEDURE LETTER CODES: I = INSPECT, R = REPLACE, C = CLEAN**

**IMPORTANT NOTE** - Time intervals shown are maximum. Actual use and your experience will determine the frequency of required maintenance.

**MAINTENANCE PROCEDURE NOTES:**

(1) Apply POWER BLENDX™ lubricant every 25 hours of use.

(2) Low evaporative fuel tanks DO NOT require regular maintenance to maintain emission integrity.

\* All recommendations to replace are based on the finding of damage or wear during inspection.

## AIR FILTER

### Level 1.

*Tools required:* Cleaning brush 25 or 50 mm (1 or 2 in.)

*Parts required:* Air Filter

1. Close choke (Cold Start Position [I]). This prevents dirt from entering the carburetor throat when the air filter is removed. Brush accumulated dirt from air cleaner area.
2. Remove air filter cover. Brush dirt from inside cover.
3. Remove air filter and lightly brush debris from filter. Replace filter if it is damaged, fuel soaked, very dirty, or the rubber sealing edges are deformed.
4. If filter can be reused, be certain it:
  - Fits tightly in the air filter cavity.
  - Is installed with the original side out.
5. Install air filter cover.

### NOTE

Carburetor adjustment may be needed after air filter cleaning/replacement. See Carburetor Adjustment Section.

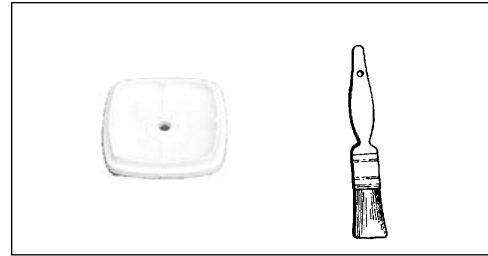

## FUEL FILTER

### Level 1.

*Tools required:* 200-250 mm (8 - 10 in.) length of wire with one end bent into a hook, Clean rag, funnel, and an approved fuel container

*Parts Required:* Fuel Filter



### DANGER

Fuel is **VERY** flammable. Use extreme care when mixing, storing or handling or serious personal injury may result.

1. Use a clean rag to remove loose dirt from around fuel cap and empty fuel tank.
2. Use the "fuel line hook" to pull the fuel line and filter from the tank.
3. Remove the filter from the line and install the new filter.

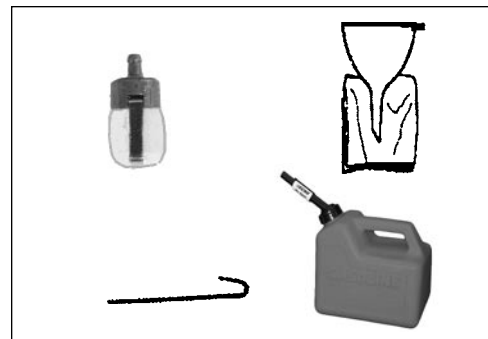

## SPARK PLUG

### Level 2.

*Tools required:* 10x19mm (13/32x3/4in) T-wrench, Feeler gauge, Soft metal brush

*Parts Required:* Spark Plug NGK BPM-8Y

#### IMPORTANT

Use only NGK BPM-8Y spark plug (BPMR-8Y in Canada) otherwise severe engine damage may occur.

1. Remove spark plug and check for fouling, worn and rounded center electrode.
2. Clean the plug or replace with a new one. DO NOT sand blast to clean. Remaining sand will damage engine.
3. Adjust spark plug gap 0.65mm (0.026 in.) by bending outer electrode.
4. Tighten spark plug to 150-170 kgf • cm (130-150 in • lbf).

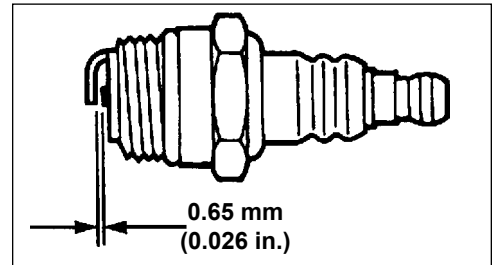
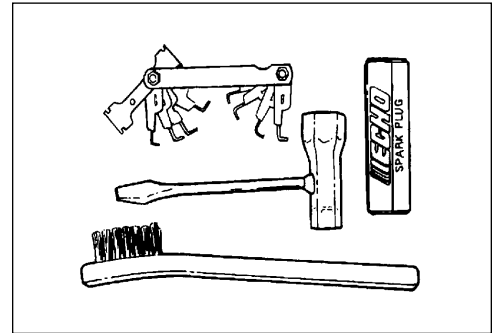

## COOLING SYSTEM CLEANING

### Level 2.

*Tools required:* 4 mm Hex wrench, Cleaning brush 25 - 50 mm (1 - 2 in.)

*Parts Required:* None.

#### IMPORTANT

To maintain proper engine operating temperatures, cooling air must pass freely through the cylinder fin area. This flow of air carries combustion heat away from the engine.

Overheating and engine seizure can occur when:

- Air intakes are blocked, preventing cooling air from reaching the cylinder.
- Dust and grass build up on the outside of the cylinder. This build up insulates the engine and prevents the heat from leaving.

Removal of cooling passage blockages or cleaning of cooling fins is considered "Normal Maintenance." Any failure attributed to lack of maintenance is not warranted.

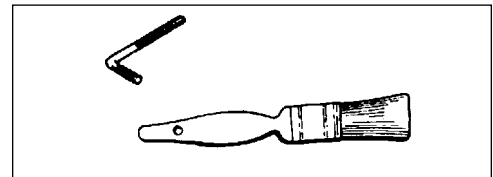

1. Remove spark plug lead.
2. Remove air cleaner cover.
3. Remove muffler cover screw and muffler cover (A).
4. Remove 2 engine cover screws and engine cover (B).

**IMPORTANT**

DO NOT use a metal scraper to remove dirt from the cylinder fins.

5. Use brush to remove dirt from the cylinder fins.
6. Remove grass and leaves from the grid between the recoil starter and fuel tank.
7. Assemble components in reverse order.

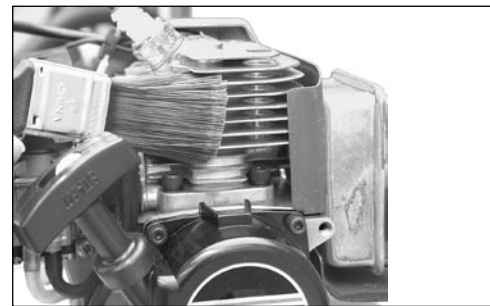
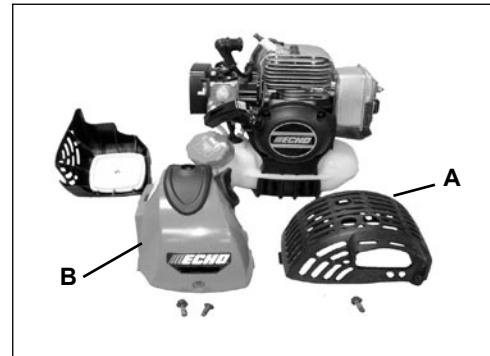

## EXHAUST SYSTEM

### Spark Arrestor Screen

#### Level 2.

*Tools Required:* Cross Head Screwdriver, 4mm Hex Wrench, Soft Metal Brush

*Parts Required:* Spark Arrestor Screen, Gasket

1. Remove muffler cover screw and muffler cover (A).
2. Place piston at Top Dead Center (TDC) to prevent carbon/dirt from entering cylinder.
3. Remove spark arrestor screen (B), gasket (C) and exhaust guide (D) from muffler body.
4. Clean carbon deposits from muffler components.

**NOTE**

When cleaning carbon deposit, be careful not to damage the catalytic element inside muffler.

5. Replace screen if it is cracked, plugged or has holes burned through.
6. Assemble components in reverse order.

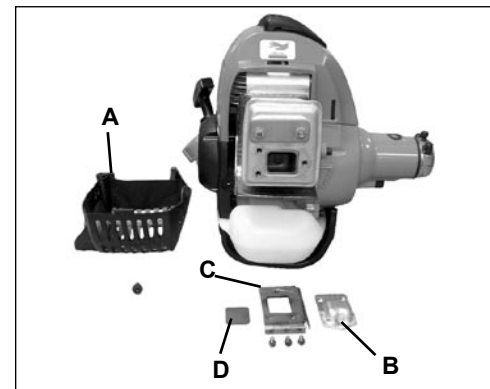
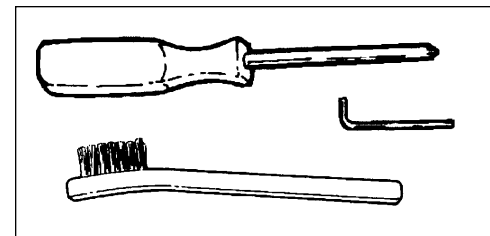



## Exhaust Port Cleaning

### Level 2.

*Tools required:* 4mm Hex Wrench, 8mm Wrench, Wood or plastic scraper

*Parts Required:* As needed: Heat Shield

1. Remove spark plug lead from spark plug, and remove muffler cover (1 screw).
2. Place piston at top dead center. Remove muffler (A) and heat shield (B).
3. Use a wood or plastic scraping tool to clean deposits from cylinder exhaust port.

#### **IMPORTANT**

Never use a metal tool to scrape carbon from the exhaust port. Do not scratch the cylinder or piston when cleaning the exhaust port. Do not allow carbon particles to enter the cylinder.

4. Inspect heat shield, and replace if damaged.
5. Install heat shield and muffler.
6. Tighten muffler mounting bolts (or nuts) to 60-70 in•lbf (70-80 kgf•cm).
7. Start engine, and warm to operating temperature.
8. Stop engine, and re-tighten mounting bolts (or nuts) to specifications.
9. Install muffler cover and attach spark plug lead.

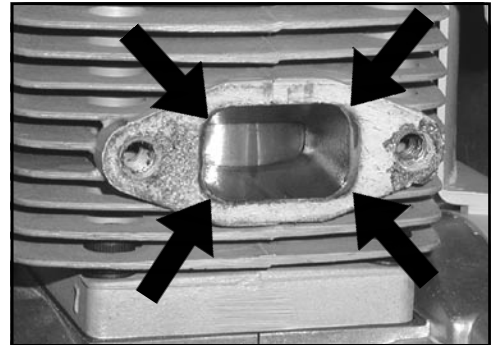
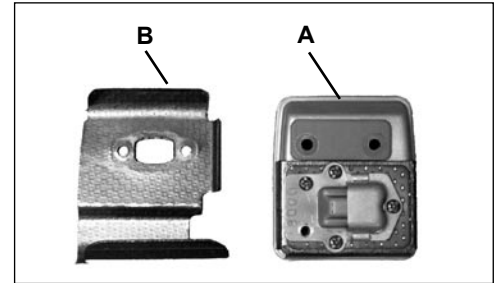
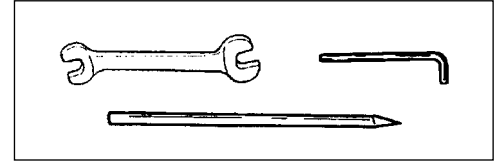

## CARBURETOR ADJUSTMENT

### *Engine Break-In*

New engines must be operated a minimum duration of two tanks of fuel break-in before carburetor adjustments can be made. During the break-in period your engine performance will increase and exhaust emissions will stabilize. Idle speed can be adjusted as required.

This engine has been factory adjusted to maintain satisfactory starting, emission, and durability performance up to 1,100 feet mean sea level (MSL) (96.0 kPa and below). To maintain proper engine operation and emission compliance above 1,100 feet MSL the carburetor may need to be adjusted by an authorized ECHO service dealer.

### IMPORTANT

If the engine is adjusted for operation *above* 1,100 feet MSL, the carburetor must be re-adjusted when operating the engine *below* 1,100 feet MSL, otherwise severe engine damage can result.

### Level 2.

*Tools required:* Screwdriver, Tachometer (ECHO P/N 99051130017).

*Parts required:* None.

### NOTE

Every unit is run at the factory and the carburetor is set in compliance with emission regulations. Carburetor adjustments, other than idle speed, must be performed by an authorized ECHO dealer.

1. Check idle speed and reset if necessary. If a tachometer is available, idle speed screw (A) should be set to the specifications found on page 33 "Specifications" of this manual. Turn idle screw (A) clockwise to increase idle speed; counter clockwise to decrease idle speed.



### WARNING

When carburetor adjustment is completed, the cutting attachment should not turn at idle, otherwise serious personal injury may result.

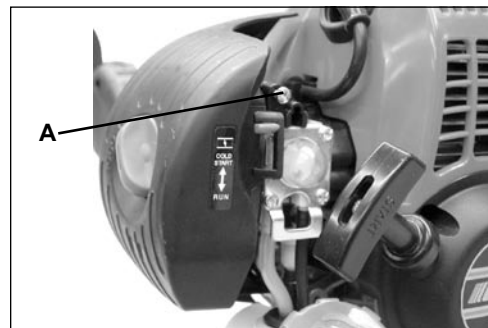
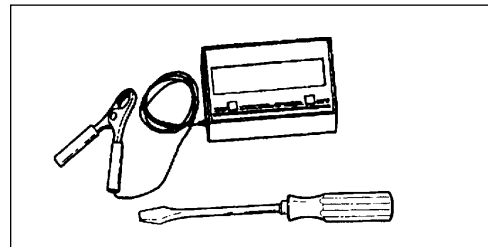

## GUIDE BAR AND SAW CHAIN REPLACEMENT



### WARNING

Never try to replace or adjust guide bar and saw chain with engine running. Always disconnect spark plug wire before servicing guide bar and saw chain. This saw chain is **VERY** sharp, wear heavy gloves to protect your hands when handling it. Wear eye protection meeting CE or ANSI specification Z87.1.

### Guide Bar Replacement / Installation

#### Level 2

*Tools Required:* 10 x 19 mm (13/32 x 3/4 in.) T-wrench, 4mm Hex Wrench

1. Remove two (2) 6 mm guide bar nuts (A) and guide bar cover screw (B), and turn saw chain tension adjustment screw (C) counterclockwise to release tension.
2. Remove guide bar cover (D).
3. Remove guide bar and saw chain from gear case and sprocket.
4. Remove chain from guide bar and check guide bar for damage and excessive or uneven wear. Replace guide bar if necessary.
5. Install chain on guide bar with cutters on top of bar facing toward bar tip.
6. Install guide bar and chain on gear case, engaging chain with drive sprocket (E).
7. Turn tension adjustment screw clockwise to take up slack in saw chain.
8. Install guide bar cover (D), and tighten guide bar nuts finger tight and install guide bar cover screw (B).
9. Adjust chain tension.

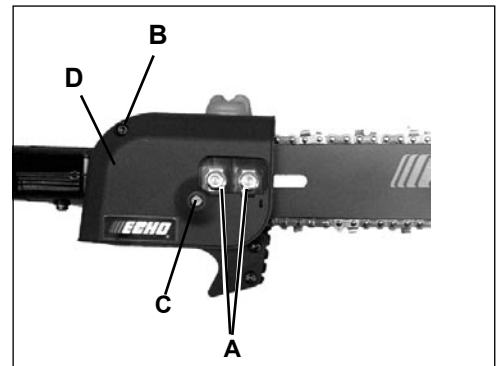
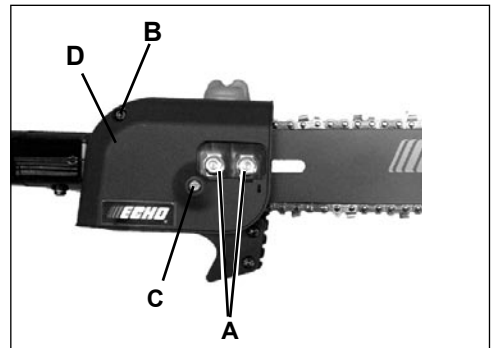

## Guide Bar Cover Cleaning

**Tools Required:** 10 x 19 mm (13/32 x 3/4 in.) T-wrench, 4mm Hex Wrench

1. Remove two (2) 6 mm guide bar nuts (A) and guide bar cover screw (B).
2. Remove guide bar cover (D).
3. Gently brush debris from inside guide bar cover and from around sprocket.
4. Install guide bar cover (D), install and tighten guide bar nuts, and install guide bar cover screw (B).

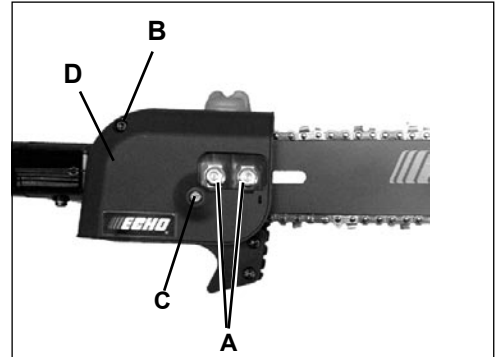

## To Adjust Saw Chain Tension

1. Move stop switch to STOP position.
2. Disconnect spark plug lead.
3. Loosen two gearcase cover nuts (A) until finger tight.
4. Hold the bar nose up, and turn the adjuster screw (B) clockwise until the chain fits snugly against the underside of the bar, as shown. Cold Chain Only - turn adjuster screw CW an additional 1/8 - 1/4 turn.
5. Tighten both gearcase cover nuts with nose held up. Tighten rear nut first.
6. Pull the chain around the guide bar by hand. Reduce the chain tension if you feel tight spots.
7. When chain is properly tensioned, tighten gear case cover nuts securely.

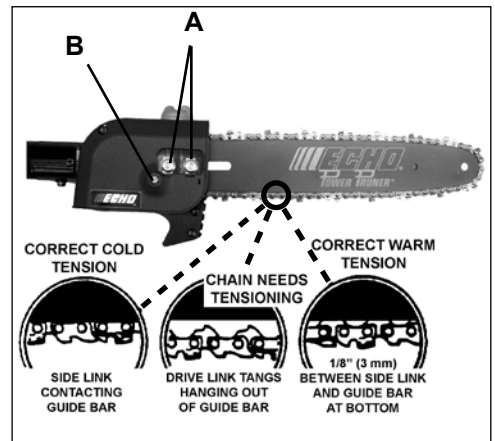

### IMPORTANT

Tighten gearcase cover nuts to 8 - 9 N•m (71 - 80 in. lbs.) DO NOT over-tighten nuts. Damage may result.

8. Keep chain properly tensioned at all times.

### NOTE

All chains require frequent adjustment.

9. Connect spark plug lead.

<b>PPT-265 Power Pruner B&amp;C Combinations</b>						
	<b>Bar P/N</b>	<b>Chain P/N</b>	<b>Chain Type</b>	<b>Links</b>	<b>Pitch</b>	<b>Gauge</b>
<b>Standard</b>						
	12" Regular Bar P/N 12A OCD3744	M91VX44G	91	44	3/8"	.050
<b>Optional</b>						
	10" Regular Bar P/N 10A OCD3739	M91VX39G	91	39	3/8"	.050
	14" Regular Bar P/N 14A OCD3749	M91VX49G	91	49	3/8"	.050
<b>Narrow Kerf</b>						
	10" Narrow Bar P/N 10A4CD3739	90SG39G	90	39	3/8"	.043
	12" Narrow Bar P/N 12A4CD3744	90SG44G	90	44	3/8"	.043
	14" Narrow Bar P/N 14A4CD3749	90SG49G	90	49	3/8"	.043

**IMPORTANT**

Chain and guide bar gauge size must be identical. Use Bar/Chain combinations shown in table above.

## FILING SAW CHAIN

Level 2.

*Tools required:* 4 mm (5/32 in.) Round File, Flat File, Depth Gauge

### IMPORTANT

Dull or damaged cutters will result in poor cutting performance, increased vibration, and premature saw chain failure.



### WARNING

Always stop engine and disconnect spark plug wire before servicing guide bar and saw chain. Always wear gloves when filing saw chain, otherwise serious personal injury may result.

1. Set round file (A) in cutter at 30° angle. One fifth (1/5) of the file should be exposed above top cutter edge.
2. Keep file horizontal in cutter and file in one direction.
3. File until cutter top and side bevel edges are sharp without nicks.
4. Place depth gauge tool (B) firmly on top of cutter with .025 in. slot and end against front cutter raker. File cutter raker with flat file until flush with top of depth gauge.
5. Finish cutter sharpening by rounding front raker edge (C) with flat file.
6. Properly filed cutter is as shown.
7. Apply clean oil and rotate saw chain slowly to wash away filings.
8. If saw chain is coated or clogged with resin, clean in kerosene, then soak in oil.

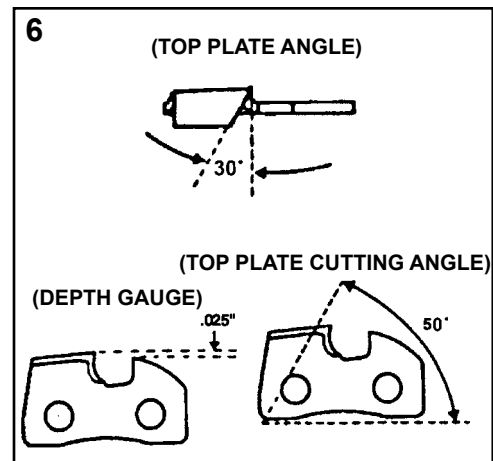
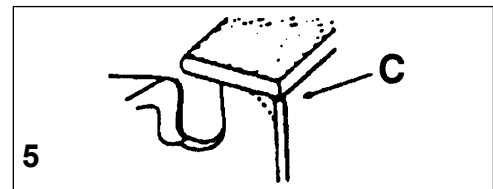
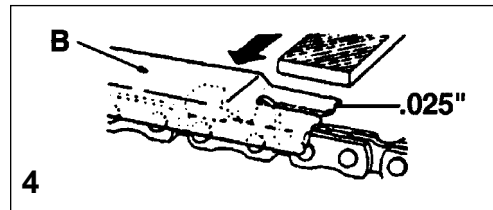
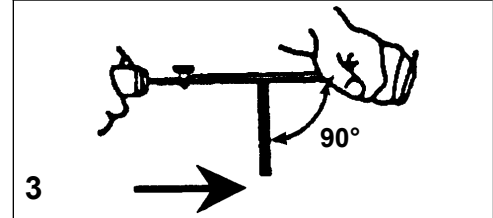
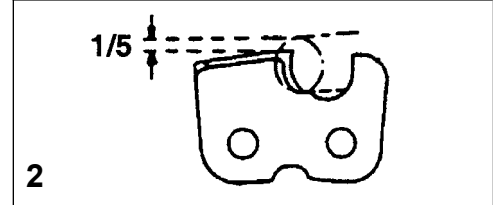
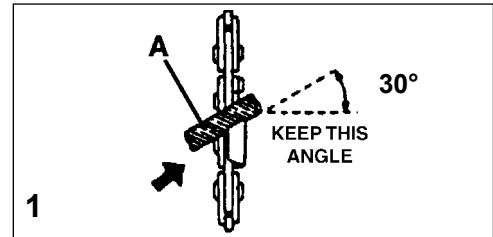

## TROUBLESHOOTING

ENGINE PROBLEM TROUBLESHOOTING CHART				
Problem	Check	Status	Cause	Remedy
Engine cranks - starts hard/ doesn't start	Fuel at carburetor	No fuel at carburetor	Fuel strainer clogged Fuel line clogged Carburetor	Clean or replace Clean or replace See your Echo dealer
	Fuel at cylinder	No fuel at cylinder	Carburetor	See your Echo dealer
		Muffler wet with fuel	Fuel Mixture too rich	Open choke Clean/replace air filter Adjust carburetor See your Echo dealer
	Spark at end of plug wire	No spark	Stop switch off Electrical problem Interlock switch	Turn switch to ON See your Echo dealer See your Echo dealer
	Spark at plug	No spark	Spark gap incorrect Covered with carbon Fouled with fuel Plug defective	Adjust to .65mm (0.026 in.) Clean or replace Clean or replace Replace plug
Engine runs, but dies or does not accelerate properly	Air filter	Air filter dirty	Normal wear	Clean or replace
	Fuel filter	Fuel filter dirty	Contaminants/residues in fuel	Replace
	Fuel vent	Fuel vent plugged	Contaminants/residues in fuel	Clean or replace
	Spark Plug	Plug dirty/worn	Normal wear	Clean and adjust or replace
	Carburetor	Improper adjustment	Vibration	Adjust
	Cooling System	Cooling system dirty/plugged	Extended operation in dirty/dusty locations	Clean
	Spark Arrestor Screen	Spark arrestor screen plugged	Normal wear	Replace
Engine does not crank	N/A	N/A	Internal engine problem	See your Echo dealer



### **DANGER**

Fuel vapors are **extremely** flammable and may cause fire and/or explosion. **Never** test for ignition spark by grounding spark plug near cylinder plug hole, otherwise serious personal injury may result.

## STORAGE



### WARNING

During operation the muffler or catalytic muffler and surrounding cover become hot. Always keep exhaust area clear of flammable debris during transportation or when storing, otherwise serious property damage or personal injury may result.

### *Long Term Storage (over 30 days)*

Do not store your unit for a prolonged period of time (30 days or longer) without performing protective storage maintenance which includes the following:

1. Store unit in a dry, dust free place, out of the reach of children.



### DANGER

Do not store in enclosure where fuel fumes may accumulate or reach an open flame or spark or serious personal injury may result.

2. Place the stop switch in the "OFF" position.
3. Remove accumulation of grease, oil, dirt and debris from exterior of unit.
4. Perform all periodic lubrication and services that are required.
5. Tighten all the screws and nuts.
6. **Drain** the fuel tank **completely** and pull the recoil starter handle several times to remove fuel from the carburetor.
7. Remove the spark plug and pour 7 cc (1/4 oz.) of fresh, clean, two-stroke engine oil into the cylinder through the spark plug hole.
  - A. Place a clean cloth over the spark plug hole.
  - B. Pull the recoil starter handle 2-3 times to distribute the oil inside the engine.
  - C. Observe the piston location through the spark plug hole. Pull the recoil starter handle slowly until the piston reaches the top of its travel and leave it there.
8. Install the spark plug (do not connect spark plug cable).
9. Install the guide bar cover on the guide bar and saw chain during storage.

### IMPORTANT

Some tree sap and resins are corrosive. Thoroughly wash the guide bar and sprocket areas after each use, then coat metal parts with light oil.



## SPECIFICATIONS

<b>MODEL</b> .....	<b>PPT-265S</b>
Length (Standard).....	1.96 m (6 ft. 5 in.)
Length (Extended).....	2.41 m (7 ft. 11 in.)
Length w/extension.....	3.94 m (12 ft. 11 in.)
Width .....	.25 m (9.8 in.)
Height .....	.25 m (9.7 in.)
Weight (dry) .....	7.5 kg (16.5 lb.)
Engine Type .....	Air cooled, two-stroke, single cylinder gasoline engine
Bore.....	34.0 mm (1.34 in.)
Stroke.....	28.0 mm (1.10 in.)
Displacement .....	25.4 cc (1.55 cu. in.)
Exhaust System .....	Spark Arrestor Muffler w/catalyst
Carburetor.....	Zama with Purge
Ignition System .....	CDI (capacitor discharge ignition)
Spark Plug .....	NGK BPM-8Y Gap 0.65 mm (0.026 in.)
Fuel .....	Mixed (Gasoline and Two-stroke Oil)
Fuel/Oil Ratio .....	50 : 1 Power Blend X™ ISO-L-EGD (ISO/CD 13738) and J.A.S.O. M345- <u>FC/FD</u> , two-stroke, air-cooled engine oil.
Gasoline.....	Use 89 Octane unleaded. Do not use fuel containing methyl alcohol, more than 10% ethyl alcohol or 15% MTBE. Do not use alternative fuels such as E-20 or E-85.
Oil.....	Power Blend X™ Premium Universal 2-Stroke Oil
Fuel Tank Capacity .....	0.50 lit. (16.9 US fl. oz.)
Starter System .....	Automatic Recoil Starter
Clutch.....	Centrifugal Type
Sprocket Type .....	6 tooth spur, 9.53 mm (3/8 in.) pitch
Power Transmission Shaft Assembly .....	Aluminum Extrusion
Gear Case Ratio.....	1.5:1
Oiling System .....	Automatic
Saw Chain Oil Capacity .....	225 ml (7.6 oz.)
Handle.....	Right hand grip w/throttle trigger and lockout
Shoulder Harness .....	Standard
Idle Speed (RPM).....	2,600 - 3,200
Clutch Engagement Speed (RPM).....	3,600 - 4,200
Wide Open Throttle Speed (RPM) .....	9,500 - 11,500
Guide Bar and Saw Chain (91).....	305 mm (12 in.); 9.53 mm (3/8 in.) pitch, 0.050 gauge

NOTES

NOTES

## SERVICING INFORMATION

### PARTS/SERIAL NUMBER

Genuine ECHO Parts and ECHO REPOWER™ Parts and Assemblies for your ECHO products are available only from an Authorized ECHO Dealer. When you do need to buy parts **always** have the Model Number, Type and Serial Number of the unit with you. You can find these numbers on the engine housing. For future reference, write them in the space provided below.

Model No. \_\_\_\_\_ Type \_\_\_\_\_ SN. \_\_\_\_\_

### SERVICE

Service of this product during the warranty period must be performed by an Authorized ECHO Service Dealer. For the name and address of the Authorized ECHO Service Dealer nearest you, ask your retailer or call: 1-800-432-ECHO (3246). Dealer information is also available on our Web Site. When presenting your unit for Warranty service/repairs, proof of purchase is required.

### ECHO CONSUMER PRODUCT SUPPORT

If you require assistance or have questions concerning the application, operation or maintenance of this product you may call the ECHO Consumer Product Support Department at 1-800-673-1558 from 8:30 am to 4:30 pm (Central Standard Time) Monday through Friday. Before calling, please know the model and serial number of your unit to help your Consumer Product Support Representative.

### WARRANTY REGISTRATION

To ensure trouble free warranty coverage it is important that you register your ECHO equipment on-line at [www.echo-usa.com](http://www.echo-usa.com). Other registration options are by automated phone at 1-800-432-3246 or by filling out the warranty registration card supplied with your unit. Registering your product confirms your warranty coverage and provides a direct link between you and ECHO if we find it necessary to contact you.

### ADDITIONAL OR REPLACEMENT MANUALS

**Safety Manuals** in English/Spanish or English/French are available, free of charge, from your ECHO dealer or at [www.echo-usa.com](http://www.echo-usa.com).

**Operator's and Parts Manuals** are available by:

- Downloading free from [www.echo-usa.com](http://www.echo-usa.com)
- Purchasing from your Echo Dealer.
- Manuals are available by sending a written request stating the model number and serial number of your Echo unit, part number of the manual, your name and address, and mail to the address below.

**Safety Videos** are available from your Echo dealer. A \$5.00 shipping charge will be required for each video.



### DEALER?

Call  
**1-800-432-ECHO**  
**1-800-432-3246**  
or  
[www.echo-usa.com](http://www.echo-usa.com)

### CONSUMER PRODUCT SUPPORT

**1-800-673-1558**  
**8:30 - 4:30 Mon - Fri C.S.T.**



**ECHO**  
ECHO, INCORPORATED®

400 OAKWOOD ROAD  
LAKE ZURICH, IL 60047

[www.echo-usa.com](http://www.echo-usa.com)

E10011001001/E10011999999