



## Chain Saw

### *Instruction Manual*

**MODELS : CS-330T  
CS-360T**

#### **WARNING** **DANGER**



The muffler or catalytic muffler and surrounding cover may become extremely hot.

Always keep clear of exhaust and muffler area, otherwise serious personal injury may occur.



#### **WARNING**

The engine exhaust from this product contains chemicals known to the State of California to cause cancer, birth defects or other reproductive harm.



#### **WARNING**

Read rules for safe operation and instructions carefully. ECHO provides an Instruction Manual and a Safety Manual. Both must be read and understood for proper and safe operation.

# RULES FOR SAFE OPERATION

## A. Kickback Safety Precautions for Chain Saw Users

### WARNING!

KICKBACK may occur when the nose or tip of the guide bar touches an object, or when the wood closes in and pinches the saw chain in the cut.

Tip contact in some cases may cause a lightning fast reverse REACTION, Kicking the guide bar up and back towards the operator. Pinching the saw chain along the top of the guide bar may push the guide bar rapidly back towards the operator. Either of these reactions may cause you to lose control of the saw which could result in serious personal injury.

The Kick Guard<sup>®</sup> device is not installed on the guide bar when you purchase your ECHO chain saw. The Kick Guard<sup>®</sup> can be used in a majority of cutting operations, and is especially recommended for beginners, homeowners, or chain saw novices. Most cutting operations can be accomplished with the Kick Guard<sup>®</sup> in place.

Do not rely exclusively upon the safety devices built into your saw. As a chain saw user, you should take several steps to keep your cutting jobs free from accident or injury.

1. With a basic understanding of kickback, you can reduce or eliminate the element of surprise. Sudden surprise contributes to accidents.
2. Keep a good firm grip on the saw with both hands, the right hand on the rear handle, and the left hand on the front handle, when the engine is running. Use a firm grip with thumbs and fingers encircling the chain saw handles. A firm grip will help you reduce kickback and maintain control of the saw. Don't let go.
3. Make sure that the area in which you are cutting is free from obstructions. Do not let the nose of the guide bar contact a log, branch, or any other obstruction which could be hit while you are operating the saw.
4. Cut at high engine speeds.
5. Do not overreach or cut above shoulder height.
6. Follow manufacturer's sharpening and maintenance instructions for the saw chain.
7. Only use replacement bars and chains, or the equivalent, specified by the manufacturer.

## B. Other Safety Precautions

1. Do not operate a chain saw with one hand! Serious injury to the operator, helpers, bystanders, or any combination of these persons may result from one-handed operation. A chain saw is intended for two-handed use.
2. Do not operate a chain saw when you are fatigued.
3. Use safety footwear; snug-fitting clothing; protective gloves; and eye, hearing and head protection devices. Keep long hair away from engine and air intake. Retain hair with cap or net.
4. Use caution when handling fuel. Move the chain saw at least 3 m (10 feet) from the fueling point before starting the engine.
5. Do not allow other persons to be near the chain saw when starting or cutting with the chain saw. Keep bystanders and animals out of the work area.
6. Do not start cutting until you have a clear work area, secure footing, and a planned retreat path from the falling tree.
7. Keep all parts of your body away from the saw chain when the engine is running.
8. Before you start the engine, make sure that the saw chain is not contacting anything.
9. Carry the chain saw with the engine stopped, the guide bar and saw chain to the rear, and the muffler away from your body.
10. Do not operate a chain saw that is damaged, improperly adjusted, or not completely and securely assembled. Be sure that the saw chain stops moving when the throttle control trigger is released.
11. Shut off the engine before setting the chain saw down.
12. Use extreme caution when cutting small size brush and saplings because slender material may catch the saw chain and be whipped toward you or pull you off balance.
13. When cutting a limb that is under tension, be alert for spring back so that you will not be struck when the tension in the wood fibers is released.

14. Keep the handles dry, clean, and free of oil or fuel mixture.
15. Operate the chain saw only in well-ventilated areas.
16. Do not operate a chain saw in a tree unless you have been specifically trained to do so.
17. All chain saw service, other than the items listed in the Instruction Manual maintenance instructions, should be performed by competent chain saw service personnel. (For example, if improper tools are used to remove the flywheel or if an improper tool is used to hold the flywheel in order to remove the clutch, structural damage to the flywheel could occur and could subsequently cause the flywheel to burst.)
18. When transporting your chain saw, use the appropriate guide bar scabbard.
19. Spark arrestor mufflers approved to SAE Standard J335b are Standard on ECHO Chain saws to reduce the possibility of forest fires. Do not operate the chain saw with a loose or defective muffler. Do not remove the spark arrestor screen.



### WARNING

- During operation, the muffler or catalytic muffler and surrounding cover become hot.
- Never suspend the saw on a lanyard with the engine running.
- Always use the saw from the right-hand side of your body – **NEVER** from the left side.
- Always wear proper safety clothing to protect your lower body from sharp saw chain and hot muffler.
- Always keep exhaust area clear of flammable debris during transportation or when storing, otherwise serious property damage or personal injury may result.



### WARNING

Moving parts can amputate fingers or cause severe injuries. Keep hands, clothing and loose objects away from all openings.

- **ALWAYS** stop engine, disconnect spark plug, and make sure all moving parts have come to a complete stop before removing obstructions, clearing debris, or servicing unit.
- **DO NOT** start or operate unit unless all guards and protective covers are properly assembled to unit.
- **NEVER** reach into any opening while the engine is running. Moving parts may not be visible through openings.



### WARNING

Using improper replacement components or removing safety devices may result in serious or fatal injury.















### WARNING

Check fuel system for leaks due to fuel tank damage, especially if the unit is dropped. If damage or leaks are found, do not use unit, otherwise serious personal injury or property damage may occur. Have unit repaired by an authorized servicing dealer before using.

# CONTENTS

	Page
Rules for Safe Operation.....	2
Technical Data.....	5
Emission Data.....	6
Description.....	6
Nomenclature of Parts.....	7
Preparation for Use.....	8
Fuel and Lubricant.....	10
Operation.....	11
- Starting Cold Engine.....	12
- Starting Warm Engine.....	13
- Stopping.....	13
Cutting Instructions.....	14
Maintenance and Care.....	17
- Carburetor Adjustment.....	22
- High Altitude Operation.....	22
Chain and Guide Bar Combinations.....	23
Troubleshooting.....	25
Storage.....	27
Correct Use of Chain Brake.....	27
Warranty Statements.....	29
Servicing Information.....	32

## INTERNATIONAL SYMBOLS

Symbol form/shape	Symbol description/application	Symbol form/shape	Symbol description/application
	Read and understand Operator's Manual.		Chain oil fill
	Wear eyes, ears and head protection		Chain oil pump
	Chain brake operation		Chain oiler adjustment
	Emergency stop		Carburetor adjustment - Low speed mixture
	Choke control "Cold Start" position (choke closed)		Carburetor adjustment - High speed mixture
	Gasoline and oil mixture		Carburetor adjustment - Idle speed

## TECHNICAL DATA

Model			CS-330T	CS-360T
Dimension	L x W x H	mm	277 x 247 x 214	
		inch	10.9 x 9.7 x 8.4	
Weight	Power head, dry	kg	3.6 (7.9 lb)	
			Without chain and guide bar	
Engine	Type		Air-cooled, two-stroke, single cylinder	
	Displacement		32.6 (1.989 cu.in.)	36.3 (2.215 cu.in.)
	Carburetor		Diaphragm type	
	Ignition		Flywheel magneto : CDI system	
	Spark Plug		NGK BPM-8Y	
	Starter Power transmission		Recoil starter Automatic centrifugal clutch	
Fuel	Mixture ratio		50:1 ratio with Echo Power Blend TM 2-stroke oil. 89 octane unleaded. Do not use fuel containing methyl alcohol, more than 10% ethyl alcohol or 15% MTBE. No use combustibles alternativos como <b>E-15</b> o E-85.	
	Tank Capacity	ml	310 (10.5 U.S. fl oz.)	
Oil	Bar and chain		ECHO bar and chain oil (or motor oil)	
	Tank Capacity	ml	290 (9.8 U.S. fl oz.)	
	Lubrication		Adjustable automatic oil pump	
Guide bar	Standard		14 in.	16 in.
Saw chain	Optional		12, 16 in.	12, 14 in.
Standard Features			Top Handle	
			Front hand guard,	
			Anti-vibration device,	
			Throttle control lockout	
			Chain catcher	
			Spark arrestor catalytic muffler	
Engine RPM	Idle		2,400 - 2,800	
	Clutch Engagement		4,300	
	Wide Open Throttle (WOT)		13,000 - 14,000	
Kickback Safety Features			Double Guard Low Kick Guide Bar	
			Low Kick Guard Link Saw Chain	
			Front Hand Guard/Chain Brake Lever	
			Chain Brake	
			Kick Guard	

\* Technical data subject to change without notice.

# EMISSION DATA

## EMISSION CONTROL (EXHAUST & EVAPORATIVE)

### EPA 2010 and Later

The emission control system for the engine is EM/TWC (Engine Modification and 3-way Catalyst) and for the fuel tank the Control System is EVAP (Evaporative Emissions) or N (for nylon tank). Evaporative emission may be applicable to California models only.

**An Emission Control Label** is located on the engine. (This is an EXAMPLE ONLY, information on label varies by engine FAMILY).

**EMISSION CONTROL INFORMATION**  
ENGINE FAMILY: EHX.S.0214KG DISPLACEMENT: 21.2cc  
EMISSION COMPLIANCE PERIOD = 300 HOURS  
THIS ENGINE MEETS 2010 U.S. EPA EXH/EVP \*\*\*\* AND CALIFORNIA EXH AND EVP EMISSION REGULATIONS FOR S.O.R.E. REFER TO OWNER'S MANUAL FOR MAINTENANCE SPECIFICATIONS AND ADJUSTMENTS.  
**YAMABIKO CORP.** E \*\*\*\*

**EMISSION CONTROL INFORMATION**  
ENGINE FAMILY: EHX.S.0454KA DISPLACEMENT: 45.0cc  
EMISSION COMPLIANCE PERIOD = 300 HOURS  
THIS ENGINE MEETS U.S. EPA EXH/EVP REGS FOR MODEL YEAR E \*\* REFER TO OWNER'S MANUAL FOR MAINTENANCE SPECIFICATIONS AND ADJUSTMENTS.  
**YAMABIKO CORP.** \*\*\*\* E

### PRODUCT EMISSION DURABILITY (EMISSION COMPLIANCE PERIOD)

The 300 hour emission compliance period is the time span selected by the manufacturer certifying the engine emissions output meets applicable emissions regulations, provided that approved maintenance procedures are followed as listed in the Maintenance Section of this manual.

## DESCRIPTION

The ECHO product you purchased has been factory pre-assembled for your convenience. Due to packaging restrictions, guide bar and saw chain installation and other assembly may be necessary.

After opening the carton, check for damage. Immediately notify your retailer or ECHO Dealer of damaged or missing parts. Use the contents list to check for missing parts.

## CONTENTS

- 1 - Power Head
- 1 - Guide Bar
- 1 - Kick Guard
- 1 - Hex Head Bolt
- 1 - Hex Nut
- 1 - Saw Chain
- 1 - Instruction Manual
- 1 - Safety Manual
- 1 - Warranty Registration Card
- 1 - T-Wrench
- 1 - Echo Power BlendX™ 2-stroke oil sample



# NOMENCLATURE OF PARTS

## CS-330T, CS-360T

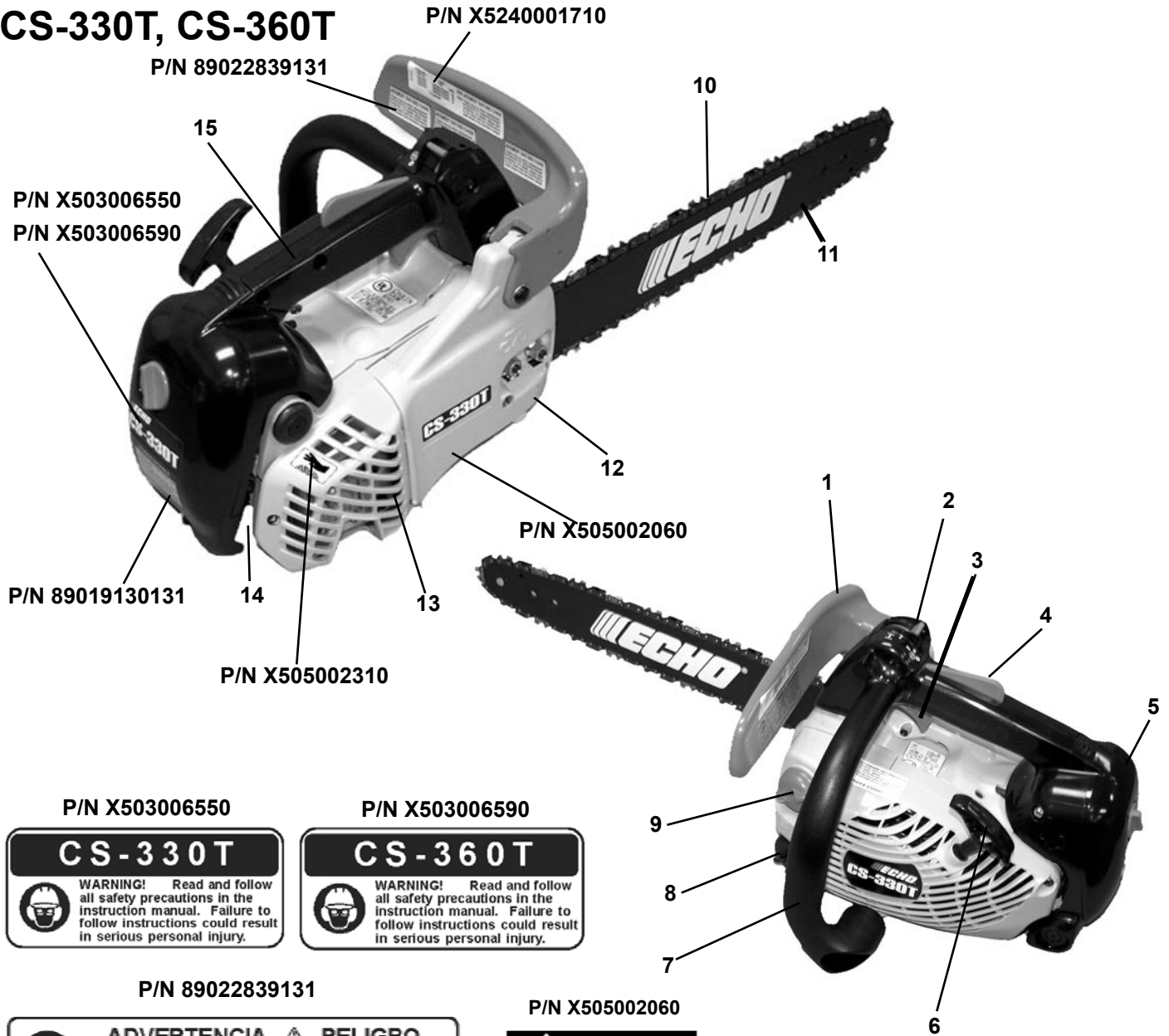

P/N X503006550

P/N X503006590

**CS-330T**

**WARNING!** Read and follow all safety precautions in the instruction manual. Failure to follow instructions could result in serious personal injury.

**CS-360T**

**WARNING!** Read and follow all safety precautions in the instruction manual. Failure to follow instructions could result in serious personal injury.

P/N 89022839131



### ADVERTENCIA PELIGRO

Esta unidad puede ser peligrosa y producir lesiones personales graves si no se usa en forma adecuada. Para reducir el riesgo de lesionarse, los operadores, los ayudantes y los espectadores deben leer y comprender el Manual Del Operador y los Manuales De Seguridad que se entregan escritos en español.

P/N X505002060

### WARNING

Chain brake must be unlocked before removing or installing clutch cover. Improper cover installation can result in serious injury and cause severe damage to saw.  
El freno de cadena debe ser bloqueado antes de remover o de instalar la cubierta del embrague. La instalación incorrecta de la cubierta puede dar lugar a lesión seria y causar daño severo a la sierra.

P/N X524001710

GUIDE BAR* PART NO.	CHAIN* TYPE	LINKS	REPLACEMENT BAR AND CHAIN
12" 12AOED3745	OREGON 91VG	45	Note: There may be other replacement components for achieving kickback protection. For details, please refer to the chain and bar combination sheet shown in the instruction manual.
14" 14AOED3752	OREGON 91VG	52	
16" 16AOED3757	OREGON 91VG	57	

P/N 89019130131

### TO AVOID KICKBACK

1. Hold the chain saw firmly with both hands
2. Don't let the nose of the guide bar contact any obstruction.
3. Tip contact may suddenly move the guide bar upward and backward, which may cause serious injury

P/N X505002310

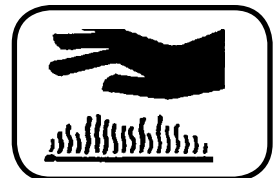

- |  |                  |
|--|------------------|
| 1. Hand guard<br>(Chain brake actuating lever) | 6. Pull starter  |
| 2. Ignition/Choke Lever                        | 7. Front handle  |
| 3. Throttle control trigger                    | 8. Oil tank cap  |
| 4. Throttle control lockout                    | 9. Fuel tank cap |
| 5. Air cleaner cover                           | 10. Saw chain    |
|  | 11. Guide bar    |

\* If a decal cannot be read, a new one can be ordered from your ECHO dealer.

- |                       |                       |
|-----------------------|-----------------------|
| 12. Sprocket guard    | 15. Rear (Top) Handle |
| 13. Catalytic muffler |                       |
| 14. Spark Plug        |                       |

# PREPARATION FOR USE

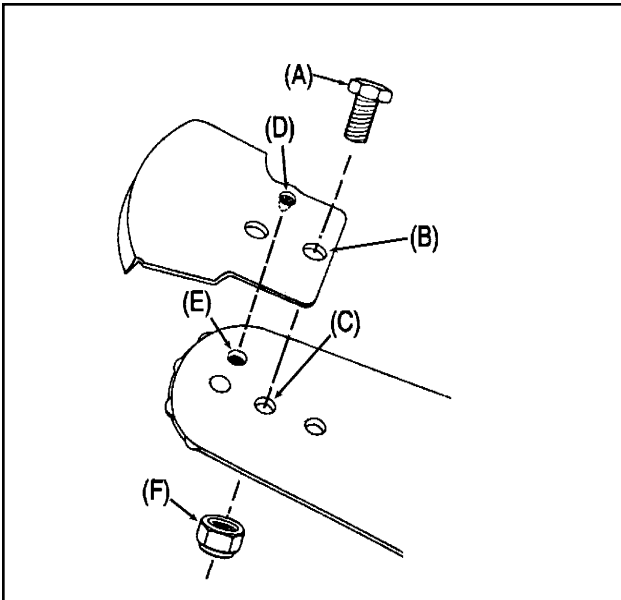

## KICK GUARD® TO BAR INSTRUCTIONS

For saws with Kick Guard® P/N 2894901 and symmetrical or asymmetrical low-kick type guide bars.

1. Install bolt (A) in **rear** hole (B) of Kick Guard® and through front hole (C) in guide bar.
2. **IMPORTANT:** Dimple in Kick Guard® (D) must engage recess in guide bar (E).
3. Tighten nut (F) and bolt (A) until snug. Make certain Kick Guard® is flush against guide bar.

## GUIDE BAR AND SAW CHAIN-INSTALL/ REMOVE



### WARNING

Saw Chain is sharp! Always wear gloves when handling assembly, otherwise serious personal injury may result.

1. Move chain brake lever (G) fully rearward to unlock chain brake.

### IMPORTANT

Always loosen guide bar nuts before turning chain tension adjuster, otherwise clutch cover and tensioner will be damaged.

2. Remove two guide bar nuts (H). Turn tension adjustment screw (J) counterclockwise 2 to 3 turns if bar and chain are installed.
3. Push clutch cover (K) forward, pull rear of cover out slightly, then remove.
4. Remove guide bar and saw chain if necessary.

### NOTE: See "MAINTENANCE AND CARE"

instructions for guide bar, sprocket, and saw chain maintenance.

5. Mount guide bar (L) on studs, and slide toward sprocket to make saw chain installation easier. Install saw chain (M) over clutch and place around sprocket and guide bar as shown, with cutters on top of guide bar facing forward.
6. Align holes of clutch cover (K) with guide bar studs, and tensioner pin (N) with lower guide bar adjuster hole. Install cover, then press and hold rear of cover to fully seat. Tighten guide bar nuts finger tight.

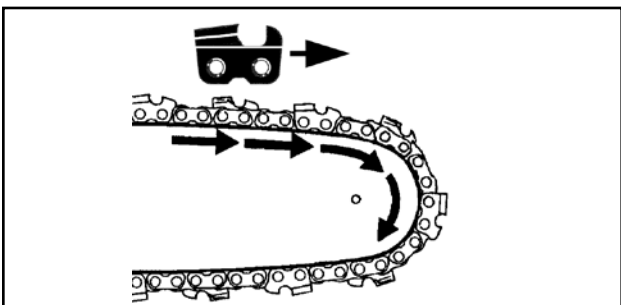
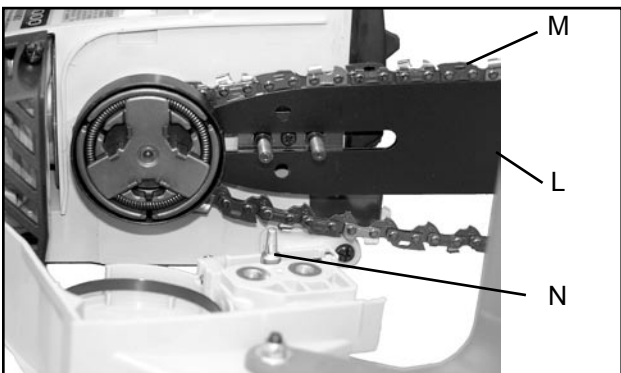
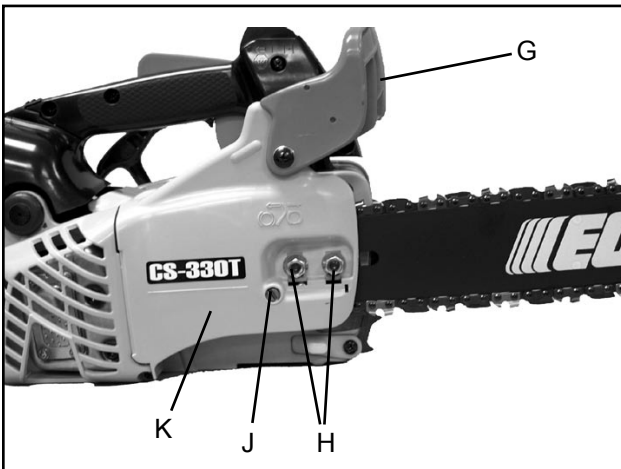



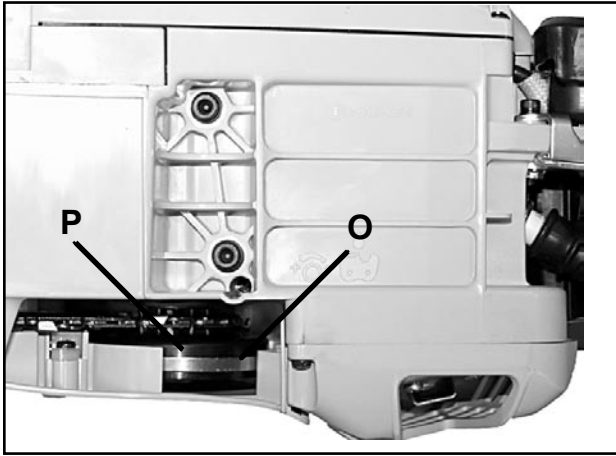

- Turn saw over and check brake band (O) for correct position around clutch drum (P). If brake band is not in place around drum, remove clutch cover, make sure brake is released, and reinstall.

**⚠ DANGER**

Never operate saw if chain brake does not function properly, otherwise saw damage and serious personal injury could result. See "Testing the Brake" instructions.

- Adjust saw chain tension, as instructed in "Adjustment, Chain Tension"

**ADJUSTMENT, CHAIN TENSION**

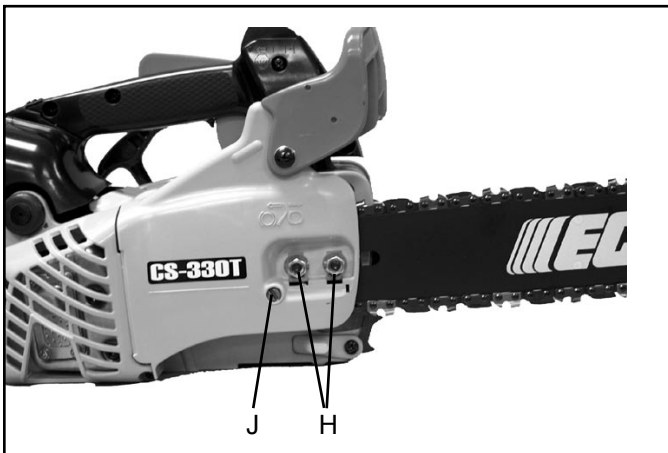

**IMPORTANT**

Always loosen guide bar nuts before turning chain tension adjuster, otherwise clutch cover and tensioner will be damaged.

- Remove air filter cover and spark plug lead.
- Loosen two guide bar nuts (H).
- Hold the bar nose up, and turn the adjuster screw (J) clockwise until the chain touches the bottom of the bar.
- Tighten both guide bar nuts with bar nose held up.



**IMPORTANT!**

Tighten guide bar nuts to 90 – 110 kgf/cm (80 – 95 in. lbs.) DO NOT over-tighten nuts. Damage to saw may result.

- Pull the saw chain around the guide bar by hand. Reduce chain tension, if you feel tight spots.

**NOTE**

All chains require frequent adjustments.

- Keep chain properly tensioned at all times.
- Replace spark plug lead and air filter cover.

# FUEL AND LUBRICANT

**NOTICE:** Use of unmixed, improperly mixed, or fuel older than 90 days, (stale fuel), may cause hard starting, poor performance, or severe engine damage and void the product warranty. Read and follow instructions in the Storage section of this manual.

## FUEL STATEMENT



### WARNING

Alternative fuels, such as E-15 (15% ethanol), E-85 (85% ethanol) or any fuels not meeting ECHO requirements are **NOT** approved for use in ECHO 2-stroke gasoline engines. Use of alternative fuels may cause performance problems, loss of power, overheating, fuel vapor lock, and unintended machine operation, including, but not limited to, improper clutch engagement. Alternative fuels may also cause premature deterioration of fuel lines, gaskets, carburetors and other engine components.

**Gasoline** - Use 89 Octane [R+M/2] (mid grade or higher) gasoline known to be good quality. Gasoline may contain up to 10% Ethanol (grain alcohol) or 15% MTBE (methyl tertiary-butyl ether). Gasoline containing methanol (wood alcohol) is **NOT** approved.

**Two Stroke Oil** - A two-stroke engine oil meeting ISO-L-EGD (ISO/CD 13738) and J.A.S.O. FC/FD Standards must be used. Echo brand premium Power Blend X™ Universal 2-Stroke Oil meets these standards. Engine problems due to inadequate lubrication caused by failure to use an ISO-L-EGD (ISO/CD 13738) and J.A.S.O. FC/FD certified oil, such as Echo premium Power Blend X™, will void the two-stroke engine warranty.

### IMPORTANT

Echo premium Power Blend X™ Universal 2-Stroke Oil may be mixed at 50:1 ratio for application in all Echo engines sold in the past regardless of ratio specified in those manuals.

## Handling Fuel



### WARNING

Fuel is **VERY** flammable. Use extreme care when mixing, storing or handling or serious personal injury may result.

- Use an approved fuel container.
- DO NOT smoke near fuel.
- DO NOT allow flames or sparks near fuel.
- Fuel tanks/cans may be under pressure. Always loosen fuel caps slowly allowing pressure to equalize.
- NEVER refuel a unit when the engine is HOT or RUNNING!
- DO NOT fill fuel tanks indoors. ALWAYS fill fuel tanks outdoors over bare ground.
- DO NOT overfill fuel tank. Wipe up spills immediately.
- Securely tighten fuel tank cap and close fuel container after refueling.
- Inspect for fuel leakage. If fuel leakage is found, do not start or operate unit until leakage is repaired.
- Move at least 3m (10 ft.) from refueling location before starting the engine.

### Mixing Instructions

1. Fill an approved fuel container with half of the required amount of gasoline.
2. Add the proper amount of 2-stroke oil to gasoline.
3. Close container and shake to mix oil with gasoline.
4. Add remaining gasoline, close fuel container, and remix.

**Fuel Mix Chart  
50:1**

Fuel to Oil Mix - 50:1 Ratio			
U.S.		METRIC	
GAS	OIL	GAS	OIL
Gallons	Fl. oz.	Liter	cc.
1	2.6	4	80
2	5.2	8	160
5	13	20	400

### IMPORTANT

Spilled fuel is a leading cause of hydrocarbon emissions. Some states may require the use of automatic fuel shut-off containers to reduce fuel spillage.

### After use

- DO NOT store a unit with fuel in its tank. Leaks can occur. Return unused fuel to an approved fuel storage container.

**Storage** - Fuel storage laws vary by locality. Contact your local government for the laws affecting your area. As a precaution, store fuel in an approved, airtight container. Store in a well-ventilated, unoccupied building, away from sparks and flames.

### IMPORTANT

Stored fuel ages. Do not mix more fuel than you expect to use in thirty (30) days, ninety (90) days when a fuel stabilizer is added.

### IMPORTANT

Stored two-stroke fuel may separate. ALWAYS shake fuel container thoroughly before each use.

## CHAIN LUBRICANT

Proper lubrication of the chain while in operation reduces friction between the chain and the guide bar to a minimum and assures a longer service life.

- Use bar and chain oil of high quality for this purpose.
- Do not use used or reclaimed oil to avoid various oiler problems.
- Use ECHO bar and chain oil.
- When ECHO bar and chain oil is not available: Use motor oil, etc.
- Use bar and chain oil of the following grades:  
SAE NO. 30 ..... in summer  
SAE NO. 10 ..... in winter or when cutting resinous trees.
- When refueling, also refill chain oil.

### TANK INDICATION



FUEL TANK



OIL TANK

## OPERATION



### WARNING

Moving parts can amputate fingers or cause severe injuries. Keep hands, clothing and loose objects away from all openings. Always stop engine, disconnect spark plug, and make sure all moving parts have come to a complete stop before removing obstructions, clearing debris, or servicing unit.



### WARNING

Engine exhaust IS HOT, and contains Carbon Monoxide (CO), a poison gas. Breathing CO can cause unconsciousness, serious injury, or death. Exhaust can cause serious burns. ALWAYS blow exhaust away from your face and body.



### WARNING

Operation of this equipment may create sparks that can start fires around dry vegetation. This unit is equipped with a spark arrestor and a spark arrestor may be required. The operator should contact local fire agencies for laws or regulations relating to fire prevention requirements.

### IMPORTANT

This saw features a combination ignition/choke switch that automatically sets the throttle speed to fast idle for quick starting. Do not squeeze trigger during cold starts until after unit has started, or fast idle and choke settings will be released, and engine may not start.

## STARTING COLD ENGINE



### WARNING

Make sure bar and chain are not touching anything when starting the saw.

1. Move chain brake lever (E) fully forward to lock chain brake before starting.
2. Fill the fuel tank with fuel. Do not over fill.
3. Fill the chain oil tank with lubricant. Do not over fill.
4. Move ignition/choke lever (A) forward to “close choke” (I) position.

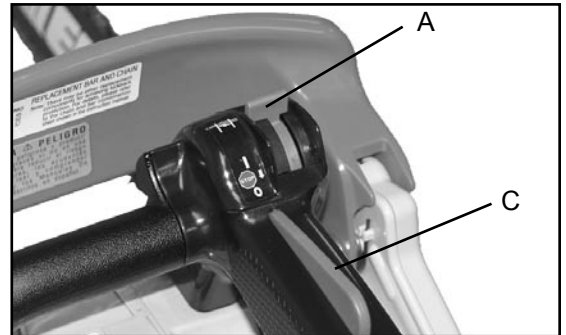

5. Lay unit on a flat, clear area and keep bar and chain clear of all obstacles. Hold top handle with one hand, and depress throttle trigger lockout (C), but do not depress throttle trigger (D).
6. Pull starter handle (F) several times until engine starts, or first starting sound is heard. (7 pulls maximum)
7. Move ignition/choke lever back to “run” (I) position (B). (Do not move to “Stop” position [G].) If necessary, start the engine.



### NOTE

If engine does not start after 3 pulls with choke in “run” (I) position, repeat cold start instructions 4-7.

8. After engine starts, wait 5 seconds then depress and release throttle trigger (D). Allow unit to warm up at idle for several minutes.

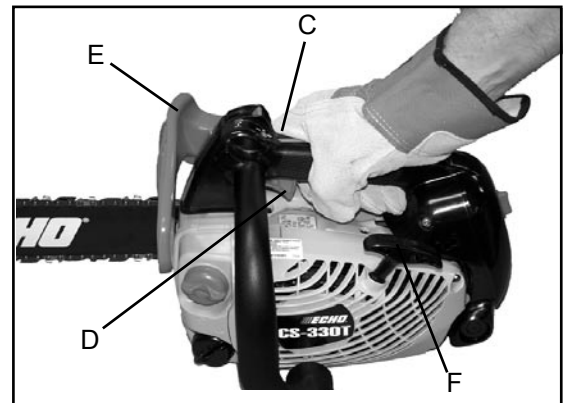

### NOTE

Do not pull starter rope out to the maximum possible position. Do not allow recoil handle to snap back against the casing.

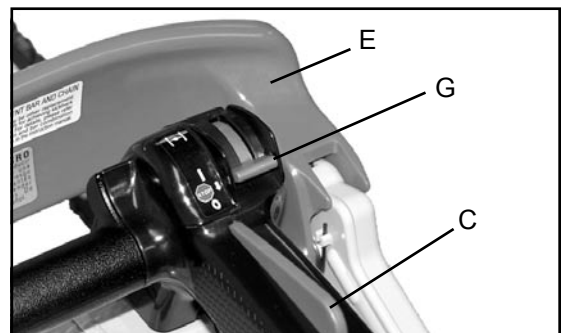

## STARTING WARM ENGINE

1. Ensure that there is fuel and chain oil in the tanks.
2. Move chain brake lever (E) fully forward to lock chain brake before starting.
3. Lay unit on a flat, clear area and keep bar and chain clear of all obstacles. Hold top handle with one hand, and depress throttle trigger lockout, but do not depress throttle trigger.
4. Move ignition/choke lever (A) forward to "Run" position ( I ).
5. Pull starter handle.

### NOTE

If engine does not start after 5 pulls, use cold start procedure.

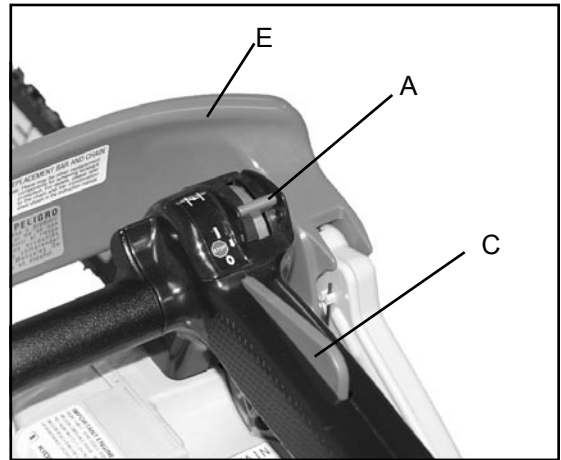

## RUNNING



### WARNING

The saw chain should not move at idle, otherwise serious personal injury may result.

### NOTE

If saw chain moves, adjust carburetor according to "Carburetor Adjustment" instructions in this manual, or see your dealer.

- After engine starts, allow it to return to idle and warm up before using.
- Move chain brake lever fully rearward to unlock chain brake.
- Press throttle control lockout then gradually squeeze throttle trigger to increase engine speed.
- Saw chain starts moving when the engine reaches approximately 4200 rpm.
- Ensure proper acceleration and lubrication of chain and bar.
- Do not run the engine at high speed unnecessarily.
- Be sure that saw chain stops moving when throttle trigger is released.

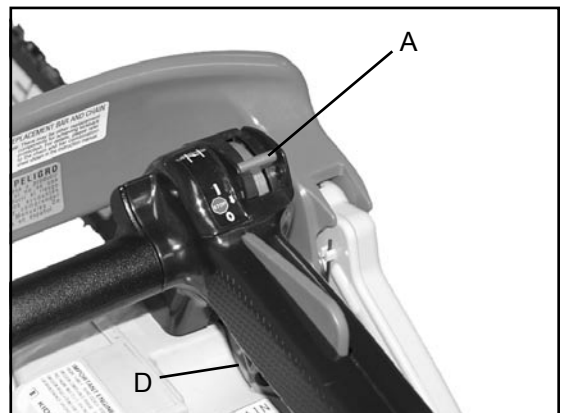

## STOPPING

1. Release throttle trigger (D) and move lever (A) rearward to STOP (O) position.
2. Move chain brake lever (E) fully forward to lock chain brake.

### NOTE

If engine does not stop, move ignition/choke lever forward to choke position ( I ) to stop engine. Return the unit to your authorized ECHO dealer to check and repair stop switch before starting the engine again.

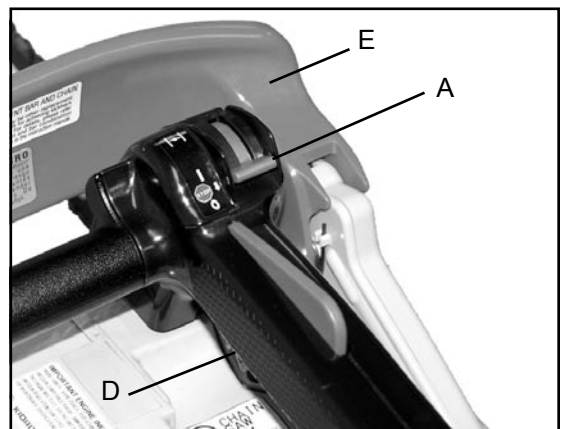

# CUTTING INSTRUCTIONS

## GENERAL

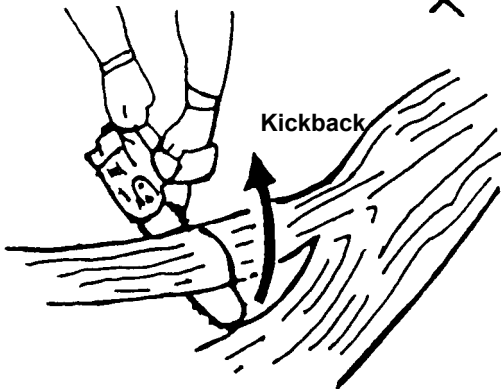
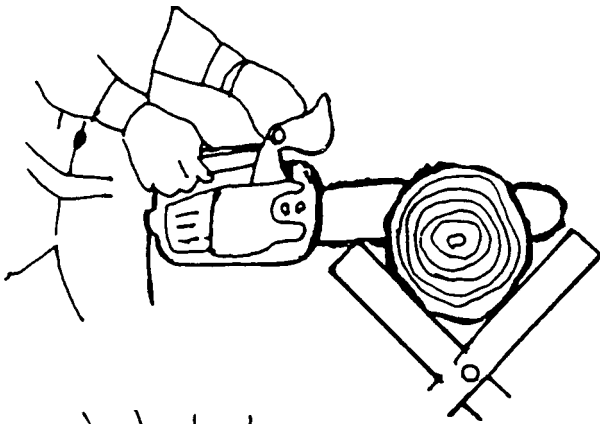
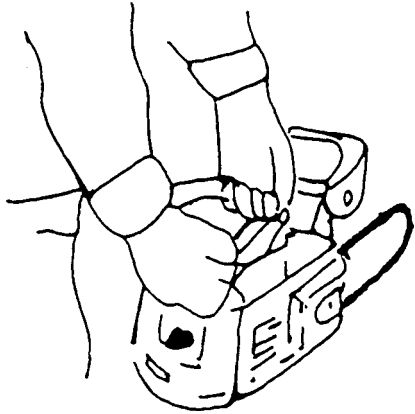

### WARNING

Read the ECHO "CHAIN SAW SAFETY MANUAL" included with your chain saw for additional cutting and safety instructions. Failure to obey all instructions may result in serious or fatal injuries.

In all circumstances the operation of the chain saw is a one-man job. It is difficult at times to take care for your own safety, so don't assume the responsibility for a helper as well. After you have learned the basic techniques of using the saw, your best aid will be your own good common sense...

The accepted way to hold the saw is to stand to the left of the saw with your left hand on the front handlebar and your right hand on the rear handle so you can operate the throttle trigger with your right index finger.

Before attempting to fell a tree, cut some small logs or limbs. Become thoroughly familiar with the controls and the responses of the saw.

Start the engine, see that it is running properly. Squeeze the trigger to open the throttle wide open and start the cut. If the chain is properly sharpened, the cutting should be relatively effortless. It is not necessary to press down hard to make the saw cut. Pushing the saw too hard will slow the engine and cutting will actually be more difficult.

### NOTE

Some material may adversely affect the housings of your ECHO chain saw.

(Example: Palm Tree Acid, fertilizer, etc.) To avoid housing deterioration, carefully remove all packed saw dust around clutch and guide bar area and wash with water. Coat metal parts with light oil.



### WARNING

Do not let the tip of the bar touch anything while the engine is running. At cutting speed the chain is moving at a high rate of speed. Should the tip contact a limb or log while the chain is moving, the tip will be pushed upward with considerable force. This is known as kickback. Avoid it!

## FELLING A TREE

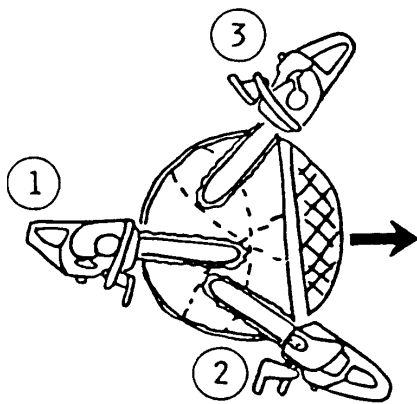
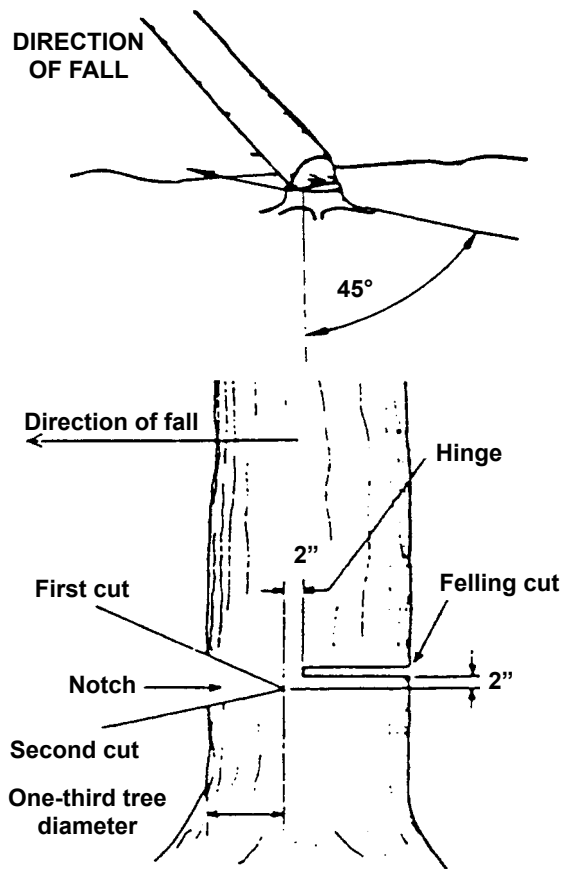

## LIMBING

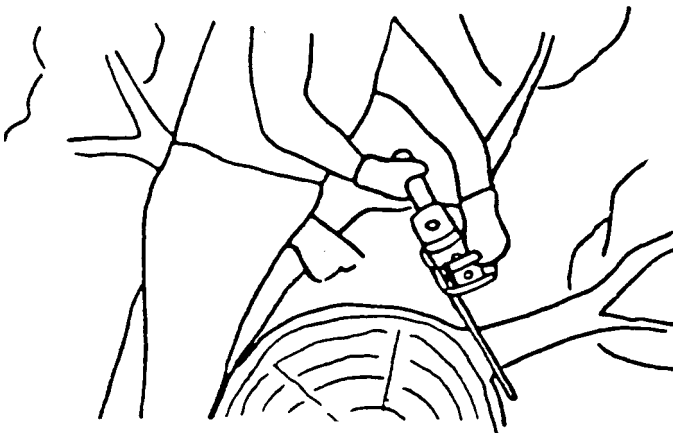

### WARNING

A falling tree can seriously damage anything it may hit - a car, a house, a fence, a power line, or another tree. There are ways to make a tree fall where you want it, so first decide where that is!

Before cutting, clear the area around the tree. You will need good footing while working and you should be able to work the saw without hitting any obstacles. Next, select a path of retreat. When the tree begins to fall you should retreat away from the direction of fall at a 45 degree angle and at least 3m from the trunk to avoid the trunk kicking back over the stump.

Begin the cut on the side to which the tree is to fall. Cut a notch about 1/3 of the way into the tree as shown. The position of this notch is important since the tree will try to fall "into" the notch. The felling cut is made on the side opposite the notch and at a level about 2" above the bottom of the notch. Do not try to cut through to the notch with the felling cut. The remaining wood between the notch cut and felling cut (about 2") will act as a hinge when the tree falls, guiding it in the desired direction. When the tree starts to fall, kill the engine, place the saw on the ground and make your retreat quickly.

To fell big trees with a diameter exceeding twice the bar length, start the notching cuts from one side and draw the saw through to the other side of the notch. Start the back cut on one side of the tree, pivoting the saw through to form the desired hinge on that side.

Then remove the saw for the second cut. Insert the saw in the first cut, very carefully so as not to cause kickback. The final cut is made by drawing the saw forward in the cut to reach the hinge.

Limbing a fallen tree is much the same as bucking. Never limb on the tree that you are standing. When limbing, caution is the word. Be careful of the tip touching other limbs. Always use both hands.



Don't cut with the saw overhead or the bar in a vertical position. If the saw should kick back you may not have good enough control to prevent possible injury.

Uphill position

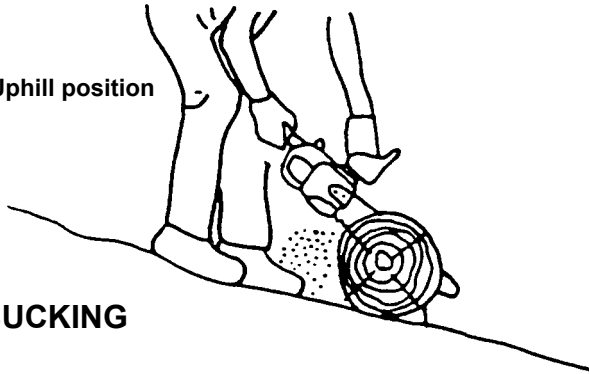

Bucking is the sawing of a log or fallen tree into smaller pieces. There are a few basic rules which apply to all bucking operations.

Keep both hands on the handles at all times.

Support logs if possible.

When cutting on a slope or hillside, always stand uphill.

## BUCKING

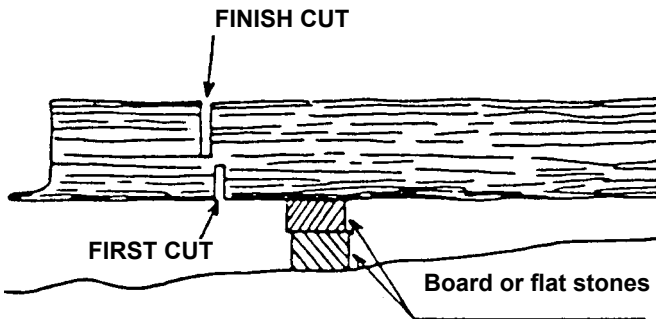

Keep in mind that the wood is heavy and that it will bend and pinch the saw if improperly supported.

The trunk will weaken at the point where you make the cut unless the tree is lying on perfectly flat ground or supported as shown.

If you make the cut with the tree on the ground, don't let the saw's chain dig into the earth; it is harmful for the saw, and you stand a good chance of being struck by flying debris. To cut the trunk, use the bucking and two-cut sequence shown. The first cut should be no deeper than one-third the trunk diameter.

## KICKBACK

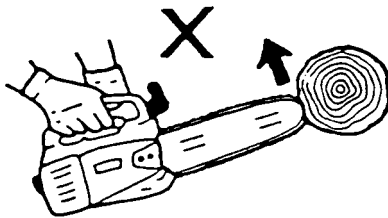

- Improper thrust cutting.

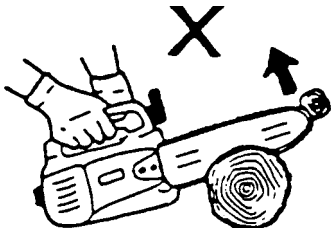

- When the bar nose hits another tree, etc.



## WARNING

### KICKBACK IS DANGEROUS

Kickback is generated when the rotation of the chain is arrested for some reason. The most dangerous effect of this action occurs when the nose of the bar contacts another object, the chain is momentarily stopped and all the energy of the engine throws the bar upwards and backwards towards the operator.

The chain saw industry and government agencies have attempted to prescribe various safety devices, but the best protection is to avoid kickback.

Comply with the Safety Precautions as listed on page 2 and 3 of this manual.



# MAINTENANCE AND CARE



## WARNING

Moving parts can amputate fingers or cause severe injuries. Keep hands, clothing and loose objects away from all openings. Always stop engine, disconnect spark plug, and make sure all moving parts have come to a complete stop before removing obstructions, clearing debris, or servicing unit. Allow unit to cool before performing service. Wear gloves to protect hands from sharp edges and hot surfaces.

Your ECHO unit is designed to provide many hours of trouble free service. Regular scheduled maintenance will help your unit achieve that goal. If you are unsure or are not equipped with the necessary tools, you may want to take your unit to an ECHO Service Dealer for maintenance. To help you decide whether you want to DO-IT-YOURSELF or have the ECHO Dealer do it, each maintenance task has been graded. If the task is not listed see your Echo dealer for repairs.

## SKILL LEVELS

**Level 1** = Easy to do. Common tools may be required.

**Level 2** = Moderate difficulty. Some specialized tools may be required.

ECHO offers **REPOWER™** Maintenance Kits and Parts to make your maintenance job easier.

## MAINTENANCE INTERVALS

COMPONENT/ SYSTEM	MAINTENANCE PROCEDURE	REQ'D SKILL LEVEL	DAILY OR BEFORE USE	EVERY REFUEL	3 MONTHS OR 90 HOURS	YEARLY 600 HOURS
Air Filter	Inspect/Clean	1	I / C *		R *	
Automatic Oiler	Inspect/Adjust	1	I			
Oil Filter	Inspect/Replace	1	I		I/C *	
Fuel System	Inspect/Replace	1	I (1) *	I (1) *		
Fuel Filter	Inspect/Replace	1			I *	I / R *
Fuel Cap Gasket	Replace	1			I *	R
Guide Bar & Sprocket Nose	Inspect/Clean/Lubricate	1	I / C *	I		
Saw Chain	Inspect/Sharpen/Replace/ Tensioning	2	I *			
Sprocket	Inspect/Replace	2	I *			
Spark Plug	Inspect/Clean	1			I / C / R *	
Cooling System	Inspect/Clean	2	I / C			
Muffler Spark Arrestor	Inspect/Clean/Replace	2			I / C / R *	
Cylinder Exhaust Port	Inspect/Clean/Decarbon	2			I / C	
Recoil Starter Rope	Inspect/Clean	1	I / C *			
Screws/Nuts/Bolts	Inspect/Tighten/Replace	1	I *			

**MAINTENANCE PROCEDURE LETTER CODES: I = INSPECT, R = REPLACE, C = CLEAN**

**IMPORTANT NOTE** - Time intervals shown are maximum. Actual use and your experience will determine the frequency of required maintenance.

### **MAINTENANCE PROCEDURE NOTES:**

(1) Low evaporative fuel tanks DO NOT require regular maintenance to maintain emission integrity.

\* Replacement is recommended based on the finding of damage or wear during inspection.

## AIR FILTER

1. Close choke (Cold Start Position [  ]). This prevents dirt from entering the carburetor throat when the air filter is removed. Brush accumulated dirt from air cleaner area.
2. Remove air filter cover. Brush dirt from inside cover.
3. Remove air filter and lightly brush debris from filter. Replace filter if it is damaged, fuel soaked, very dirty, or deformed.
4. Install air filter cover.



## AUTOMATIC OILER

- The discharge volume of the automatic oiler is adjusted to 6 to 7 cc/min (@ 7000 rpm) prior to shipment from the factory.
- Always check oil discharge when in use.
- Turn adjusting screw (D) counter-clockwise to increase oil volume, clockwise to decrease oil volume.

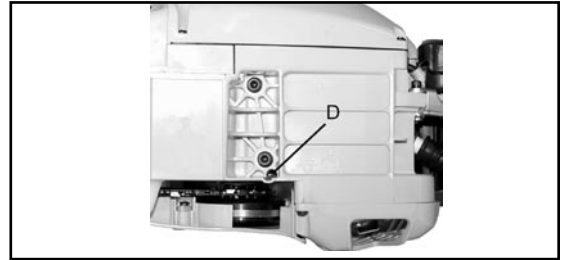

## OIL STRAINER

- Check periodically.
1. Do not allow dust to enter oil tank.
  2. Clogged oil strainer will affect the normal lubricating system
  3. Using a wire bent into the shape of a hook, pull strainer out through oil port and inspect strainer.
  4. If the strainer is dirty, clean with suitable cleaning fluid.
  5. If the inside of the oil tank is dirty, rinse with suitable cleaning fluid.
  6. Install strainer into lower front of oil tank to ensure proper chain lubrication.



## FUEL STRAINER

1. Do not allow dust to enter fuel tank.
2. Clogged strainer will cause difficulty in starting engine or abnormalities in engine performance.
3. Using a wire bent into the shape of a hook, pull strainer out through gas port, and inspect strainer.
4. If the strainer is dirty, clean with suitable cleaning fluid.
5. If the inside of the tank is dirty, rinse with suitable cleaning fluid.



## GUIDE BARS AND OIL HOLES

- Follow instructions for “Guide Bar and Saw Chain – Install/Remove”.
- Clean after each use
  - Clean the grooves (A) of the guide bar with a small screwdriver.
  - Clean oil holes (B) with a wire.

**NOTE:** Symmetrical shaped Guide Bars should be inverted each time the chain is removed to extend guide bar life.

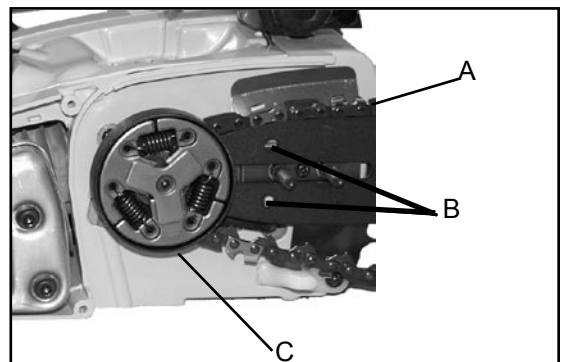

## SPROCKET

- A damaged sprocket (C) will cause premature damage or wear of saw chain.
- Clean sprocket, clutch and bar mount area before installation of bar.
- Check sprocket when you install new chain. When outer diameter of sprocket is worn 0.5mm (.020") or more, replace it.

### IMPORTANT

Some tree sap and resins are corrosive. Thoroughly wash the guide bar and sprocket areas after each use, then coat metal parts with light oil.

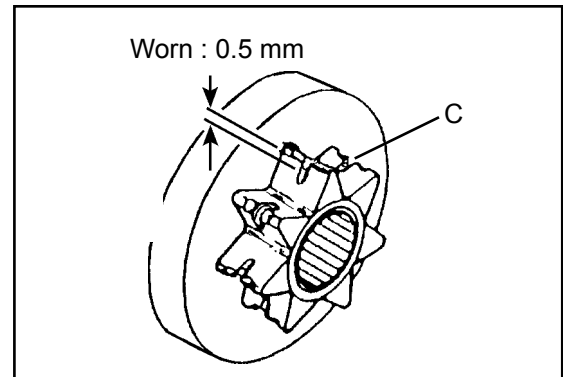

## SPARK PLUG

- Check periodically.

### IMPORTANT

Use only NGK BPM-8Y spark plug (BPMR-8Y in Canada) otherwise severe engine damage may occur.

1. Remove air cleaner cover.
2. Remove spark plug lead and spark plug.
3. Gap = 0.65 mm (0.026 in)
4. Replace if electrode is worn, or if the insulator is fouled by oil or other deposits
5. Torque = 150 – 170 kgf • cm (130 – 150 in • lbf)

### IMPORTANT

Do not over-torque

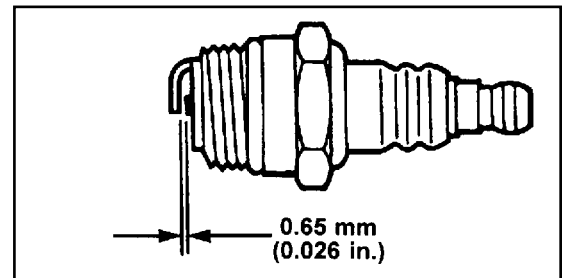

## COOLING SYSTEM CLEANING

### NOTE

See "Guide Bar and Saw Chain-Install/Remove Instructions for sprocket guard removal/replacement instructions.

### Muffler Side

1. Remove air filter cover and remove spark plug lead.
2. Remove two guide bar nuts and remove sprocket guard.
3. Remove three muffler cover screws and remove muffler cover.
4. Using a stiff bristle cleaning brush (do not use a metal brush), remove debris from cylinder fins in muffler area.
5. Assemble components in reverse order



### Starter Side

1. Remove air filter cover and remove spark plug lead.
2. Remove plastic plug in side handle mount (D), and remove side handle mounting screw.
3. Remove four starter cover screws and remove starter cover.
4. Using a stiff bristle cleaning brush (do not use a metal brush), remove debris from flywheel and ignition coil area.
5. Assemble components in reverse order.

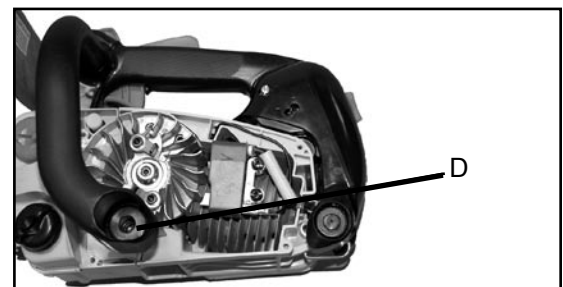

## MUFFLER SPARK ARRESTOR

### IMPORTANT

Carbon deposits in muffler will cause a drop in engine output and overheating. Spark arrestor screen must be checked periodically.

1. Remove air filter cover and remove spark plug lead.
2. Remove two guide bar nuts and remove sprocket guard.
3. Remove three muffler cover screws and remove muffler cover.
4. Remove spark arrestor screen cover, gaskets, and screen from muffler body.
5. Clean carbon deposits from muffler components.

### NOTE

When cleaning carbon deposit, be careful not to damage the catalytic element inside muffler.

6. Replace screen if it is cracked, plugged, or has holes burned through.
7. Assemble components in reverse order.

## Exhaust Port Cleaning

### Level 2.

*Tools required:* 4 mm Hex Wrench., Wood or plastic scraper

*Parts Required:* As needed: Muffler Gasket

1. Remove air filter cover and remove spark plug lead.
2. Loosen chain tension, release chain brake, and remove two guide bar nuts, clutch cover, guide bar, and chain.
3. Remove muffler cover screws and remove muffler cover. (See "Guide Bar and Saw Chain – Install/Remove" in Instruction Manual for detailed disassembly instructions.)

### NOTE

Some units may have a metal shim (A) between the muffler cover and clutch cover. Make sure shim is installed properly when reassembling parts.

4. Place piston at top dead center.
5. Remove muffler nuts (B), washer sets (C), eyeplate (D), muffler (E), and muffler gasket (F). Check parts for wear or damage, and replace if necessary.

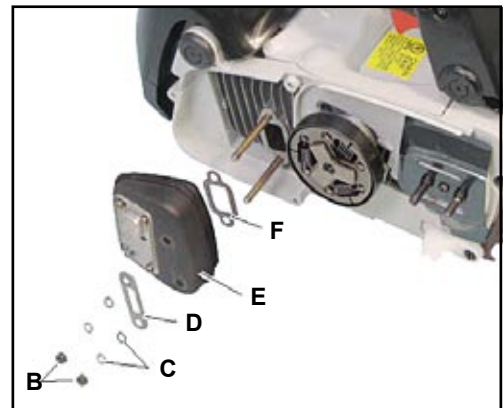
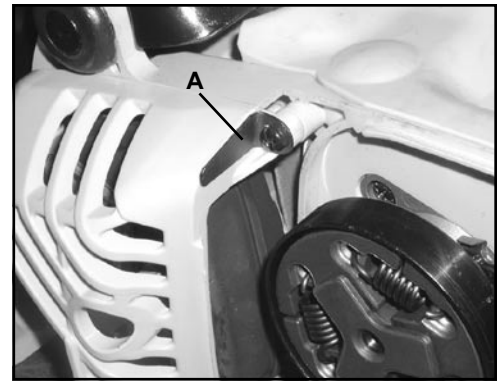
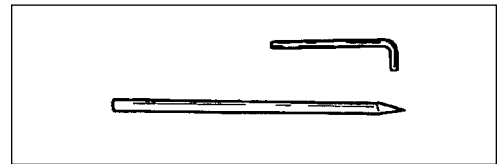

6. Use a wood or plastic scraping tool to clean deposits from cylinder exhaust ports (G).

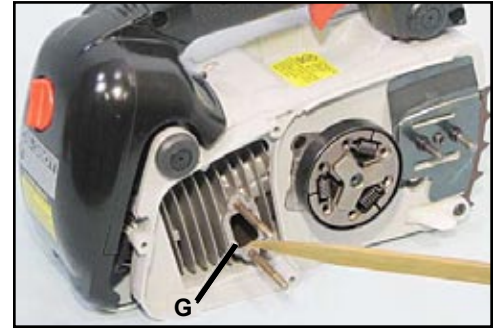

**IMPORTANT**

If muffler mounting studs loosened during muffler nut removal, tighten studs using two nuts (H) tightened together on end of stud. Turn outer nut clockwise, and tighten stud to 70 kgf • cm (7 N-m, 60 in • lbf). Do not exceed specifications, otherwise stud damage may occur. To remove nuts, hold inner nut, and turn outer nut counter clockwise to remove, then turn inner nut counter clockwise to remove.

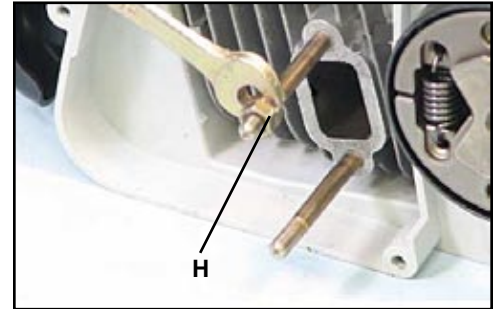

7. Install muffler gasket (F), muffler (E), eyeplate (D), washer sets (C), and muffler nuts (B). Tighten nuts to 70 kgf • cm (7 N-m, 60 in • lbf), but do not exceed specifications, otherwise damage to studs may occur.

**IMPORTANT**

Washer sets must be installed with serrated surfaces facing apart, as shown in illustration.

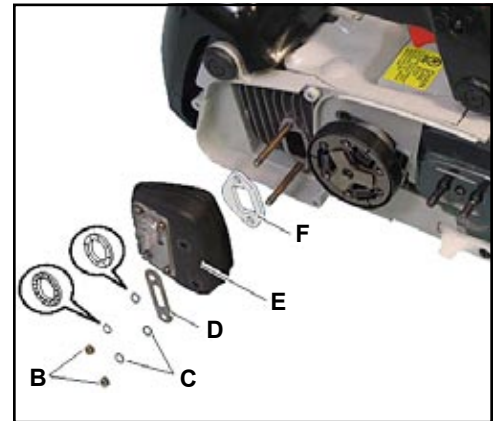

8. Connect spark plug lead and replace air filter cover.
9. Start engine, and allow unit to warm up **at idle** for several minutes.
10. Stop engine, and re-tighten mounting nuts to to 70 kgf • cm (7 N-m, 60 in • lbf), but do not exceed specifications, otherwise damage to studs may occur.
11. Install muffler cover and tighten screws.
12. Install guide bar and chain, clutch cover, and guide bar nuts, tightening nuts until finger tight. Adjust chain tension as instructed in "Adjustment, Chain Tension" section of instruction manual.
13. Start engine and check for exhaust leaks between muffler and cylinder head. Stop engine if leak is found and correct problem before operating chain saw.

## CARBURETOR ADJUSTMENT

### Engine Break-In

New engines must be operated a minimum duration of two tanks of fuel break-in before carburetor adjustments can be made. During the break-in period your engine performance will increase and exhaust emissions will stabilize. Idle speed can be adjusted as required.

### High Altitude Operation

This engine has been factory adjusted to maintain satisfactory starting, emission, and durability performance up to 1,100 feet above sea level (ASL) (96.0 kPa). To maintain proper engine operation and emission compliance above 1,100 feet ASL the carburetor may need to be adjusted by an authorized ECHO service dealer.

#### IMPORTANT

If the engine is adjusted for operation *above* 1,100 feet ASL, the carburetor must be re-adjusted when operating the engine *below* 1,100 feet ASL, otherwise severe engine damage may result.

#### BEFORE MAKING ADJUSTMENTS:

- The correct spark plug must be clean and properly gapped.
- The air filter element must be clean and properly installed.
- The muffler spark arrestor screen and exhaust port must be clear of carbon.
- The standard bar and chain combination (see page 4) must be installed to the power head, and properly tensioned.



#### WARNING

When carburetor adjustment is completed, the saw chain should not move at idle, otherwise serious personal injury may result.

#### LOW ALTITUDE ADJUSTMENT

1. Start engine and run for several minutes to reach operating temperature.
2. Stop engine.
3. Start engine and turn the high-speed needle (A) rich (CCW) until the engine runs between 13,500 and 14,500 RPM. Then turn the low-speed needle (B) rich (CCW) until the engine does not hesitate when accelerated.

#### DO NOT REMOVE LIMITER CAPS!

4. Idle Speed Adjustment.
  - Turn "idle" speed adjustment screw (C) CW until the saw chain begins to move, then turn the screw CCW until saw chain stops moving. Turn screw CCW an additional 1/4 turn.
5. Accelerate to full throttle for 2-3 seconds to clear excess fuel from engine then return to idle. Accelerate to full throttle to check for smooth transition from idle to full throttle. If engine stops or stalls after full warm up return the unit to your authorized ECHO dealer for adjustment.

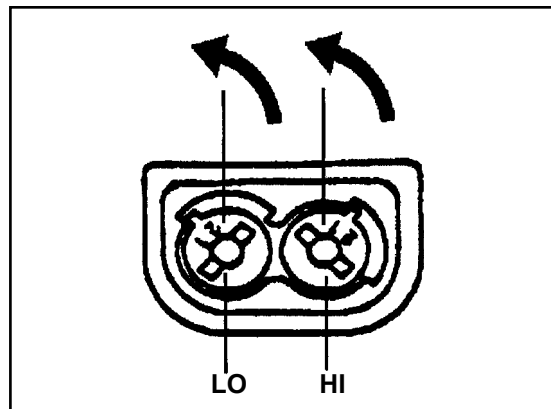
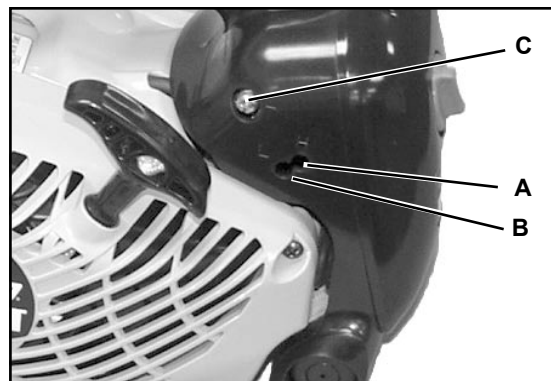

## HIGH ALTITUDE ADJUSTMENT

1. Start engine and run for several minutes to reach operating temperature.
2. Stop engine.
3. Start engine and turn the HI speed needle (A) lean (CW) until the engine runs between 13,500 and 14,500 RPM. Then turn the LO speed needle lean (B) (CW) until the engine does not hesitate when accelerated.

**DO NOT REMOVE LIMITER CAPS!**

4. Idle Speed Adjustment.
  - Turn "idle" speed adjustment screw (C) CW until the saw chain begins to move, then turn the screw CCW until saw chain stops moving. Turn screw CCW an additional 1/4 turn.
5. Accelerate to full throttle for 2-3 seconds to clear excess fuel from engine then return to idle. Accelerate to full throttle to check for smooth transition from idle to full throttle. If engine stops or stalls after full warm up return the unit to your authorized ECHO dealer for adjustment.

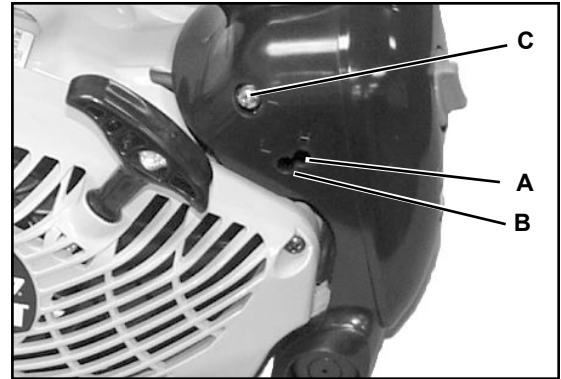

## CHAIN AND GUIDE BAR COMBINATIONS

The following combinations may be used on CS-330T and CS-360T.

MODEL	BAR LENGTH	LOW KICKBACK GUARD BAR	LOW KICKBACK SAW CHAIN					KICK GUARD
		BAR P/N	CHAIN PART NO.	LINKS	TYPE	PITCH	GAUGE	ECHO P/N (OEM P/N)
CS-330T CS-360T	12" 14" 16"	12A0ED3745 14A0ED3752 16A0ED3757	91VG-45 91VG-52 91VG-57	45 52 57	91VG	3/8"	.050	2894901 28949

\*Reduced nose radius symmetrical bars (OREGON name — Double Guard)



## WARNING

Use of replacement saw chain and/or guide bar other than that specified, or operation without the “tip guard” in place, may cause severe kickback resulting in serious injury.

Only use saw chain designated as, “LOW-KICKBACK,” that meets the ANSI B175.1-2000 Standard when tested on the representative sample of chain saws below 3.8 C.I.P. specified, and the Echo guide bar specified.

## IMPORTANT

Chain and guide bar gauge size must be identical. Use Bar/Chain combinations shown in table above.

## IMPORTANT

If your kick guard is damaged or lost, contact your Echo dealer for a replacement. For the name of the Echo dealer nearest you, Call: 1-800-432-ECHO (3246) or on the web at [www.echo-usa.com](http://www.echo-usa.com).

Refer to your Chain Saw Safety Manual for kick guard application information.

## SETTING THE SAW CHAIN

For setting saw chains, round file (4 mm  $\varnothing$ : 5/32”) and flat file are used.

- To keep correct position and correct angle, use the file holder.
  - Round file and flat file are available from your Echo Dealer.
- File cutters as below.

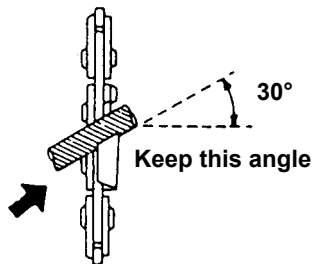

PUSH FILE AS SHOWN

To sharpen other type chain, follow chain manufacturer’s instructions

Type : 91VG

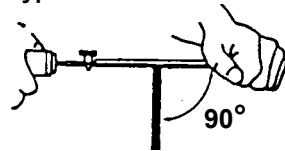

HOLD FILE HOLDER LEVEL

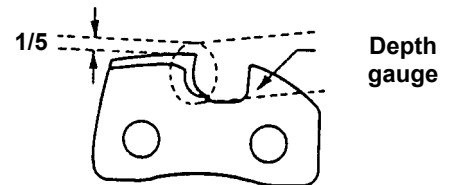

ONE FIFTH OF FILE DIAMETER REMAINS ABOVE CUTTER EDGE

- Place the depth gauge tool firmly on guide bar so that depth gauge protrudes. Then file top of depth gauge with flat file until flat with top of the gauge tool.
  - Be sure to round off the front edge of the depth gauge.

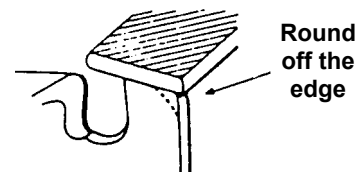
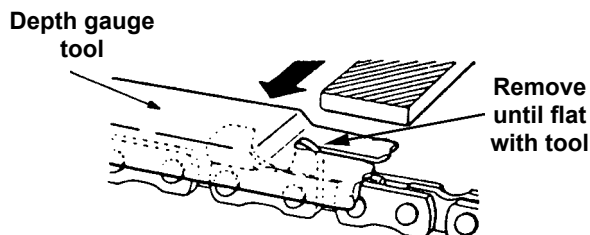



- Properly filed cutters are shown below.

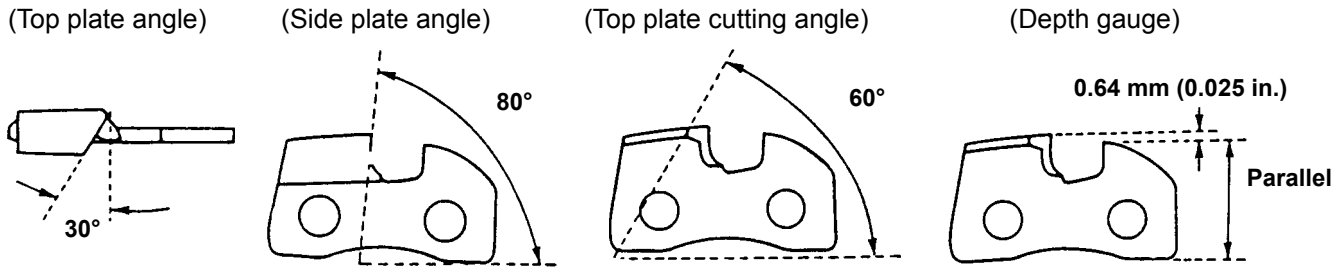

- When setting of the chain is finished, soak it in oil and wash away filings completely before using.
- When chain has been filed on the bar, supply sufficient oil to it, rotate the chain slowly to wash away the filings before using again.
- If the chain saw is operated with filings clogged in the groove, the saw chain and the guide bar will be damaged prematurely
- If the saw chain becomes soiled with resin, for instance, clean it with kerosene and soak it in oil.

### CHAIN TYPE AND SPROCKET PITCH

Saw chain should be used with corresponding pitched sprocket. To identify chain type and pitch of sprocket, check as follows.

- Chain type number (A) is stamped on drive link.
- Sprocket pitch (B) is stamped on clutch drum.

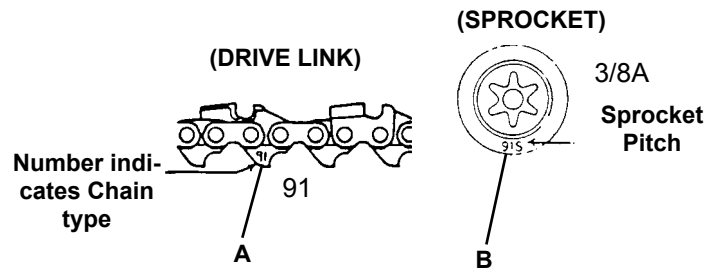

## TROUBLESHOOTING

Poor performance of the engine and/or cutting mechanism can normally be prevented by carefully following these instructions.

Poor performance can easily be corrected even by a beginner.

When the engine does not function properly check the following three (3) points first.

- Is the engine compression adequate?
- Is fuel system in good condition and is enough fuel being supplied?
- Is electrical system in good condition and is spark plug operating normally?

When there is serious trouble with the unit, do not try to repair it yourself but have your distributor or dealer do it for you. For detailed TROUBLESHOOTING refer to tables 1 and 2. Locate the problem on the following charts and repair as necessary.

### ENGINE PROBLEM TROUBLESHOOTING CHART

Problem	Check	Status	Cause	Remedy
Engine cranks - starts hard/ doesn't start	Fuel at carburetor	No fuel at carburetor	Fuel strainer clogged Fuel line clogged Carburetor	Clean or replace Clean or replace See your Echo dealer
	Fuel at cylinder	No fuel at cylinder	Carburetor	See your Echo dealer
		Muffler wet with fuel	Fuel Mixture too rich	Open choke Clean/replace air filter Adjust carburetor See your Echo dealer
	Spark at end of plug wire	No spark	Stop switch off Electrical problem Interlock switch	Turn switch to ON See your Echo dealer See your Echo dealer
	Spark at plug	No spark	Spark gap incorrect Covered with carbon Fouled with fuel Plug defective	Adjust to .65mm (0.026 in.) Clean or replace Clean or replace Replace plug
Engine runs, but dies or does not accelerate properly	Air filter	Air filter dirty	Normal wear	Clean or replace
	Fuel filter	Fuel filter dirty	Contaminants/residues in fuel	Replace
	Fuel vent	Fuel vent plugged	Contaminants/residues in fuel	Clean or replace
	Spark Plug	Plug dirty/worn	Normal wear	Clean and adjust or replace
	Carburetor	Improper adjustment	Vibration	Adjust
	Cooling System	Cooling system dirty/plugged	Extended operation in dirty/dusty locations	Clean
	Spark Arrestor Screen	Spark arrestor screen plugged	Normal wear	Replace
Engine does not crank	N/A	N/A	Internal engine problem	See your Echo dealer



### **DANGER**

Fuel vapors are extremely flammable and may cause fire and/or explosion. Never test for ignition spark by grounding spark plug near cylinder plug hole, otherwise serious personal injury may result.

## STORAGE AFTER USE

- Inspect and adjust every part of the chain saw.
  - Completely clean every part, and repair, if necessary.
  - Apply thin coating of oil on metal parts to prevent corrosion.
- Drain fuel tank, pull starter slowly a few times to drain fuel from carburetor.
- Pour a small amount of clean two-stroke oil into spark plug hole, pull starter 2 to 3 times, then leave the piston at TOP DEAD CENTER.
- Store in a dry area, free from dust.

## CORRECT USE OF CHAIN BRAKE

The installation of a chain brake may be mandatory by law or as stipulated by insurance regulations in your area of operation. You should inquire through local government offices, your employer or your local dealer to ensure that your chain saw conforms to the required safety standard. Echo chain brakes have been designed and tested to comply with international safety standards as follows.

USA: ANSI Standard B175.1-2000 Safety Requirement for chain saws

Canada: CSA Standard Z 62.1 CHAIN SAWS



### WARNING

ANSI Standard B175.1-2000 stipulates that the brake shall stop the chain in 0.15 seconds maximum (.12 sec avg) at full throttle. It is the responsibility of the Owner/Operator to ensure that the brake is serviced, adjusted and tested strictly in accordance with the instructions as detailed herein in order to ensure that the brake performance is maintained in compliance with the Standard B175.1-2000.

Kickback Motion:

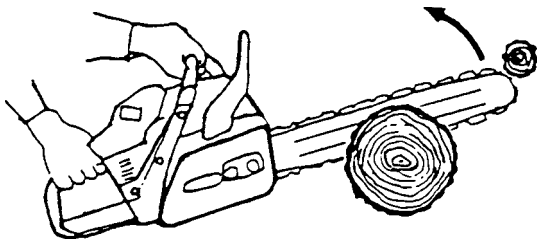

- When the bar nose hits another tree, etc.

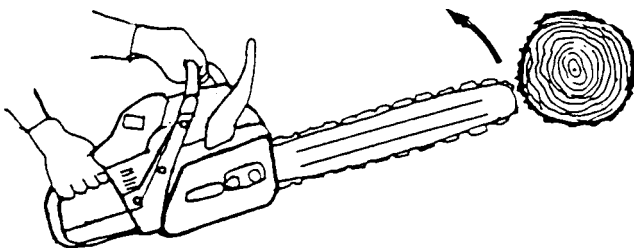

- Improper thrust cutting.

Function:

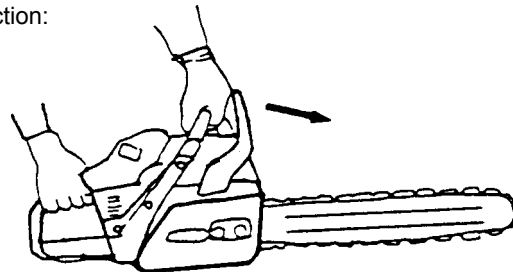

- When the lever is pushed forward, chain brake instantly works to stop the chain.

Release:

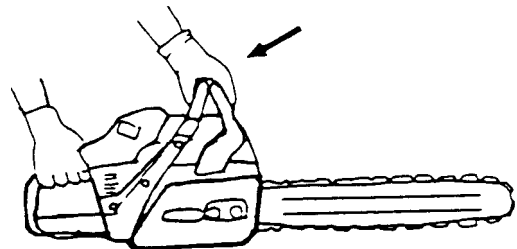

- When the lever is fully pulled toward the operator, brake is released.

## INSTALLATION

- Echo recommends that the chain brake should be serviced by an authorized Echo servicing dealer.

## OPERATION

- Set the lever in the released position before starting to cut.
- If the brake is tripped by kick back reaction, the chain will stop. Immediately release the throttle to avoid possible damage to the engine or clutch.
- Do not attempt to operate the engine with the brake engaged.

## TESTING THE BRAKE

- Start the engine on a solid level surface and run at a fast idle until warm.
- Hold the saw firmly by the handles and accelerate the engine to a fast idle.
- Slowly operate the chain brake lever while holding the saw firmly on the ground. When the brake lever trips, the chain should stop. Immediately release the throttle trigger.

### **IMPORTANT**

Do not allow the saw to tip forward in order to avoid damage to the chain.

If the chain does not stop, immediately return the saw to your authorized Echo dealer for repair.

# WARRANTY STATEMENTS

## ECHO LIMITED WARRANTY STATEMENT FOR PRODUCT SOLD IN USA AND CANADA BEGINNING 01/01/2010

### ECHO'S RESPONSIBILITY

ECHO Incorporated's Limited Warranty, provides to the original purchaser that this ECHO product is free from defects in material and workmanship. Under normal use and maintenance from date of purchase, ECHO agrees to repair or replace at ECHO's discretion, any defective product free of charge at any authorized ECHO servicing dealer within listed below application time periods, limitations and exclusions. **THIS LIMITED WARRANTY IS ONLY APPLICABLE TO ECHO PRODUCTS SOLD BY AUTHORIZED ECHO DEALERS. IT IS EXTENDED TO THE ORIGINAL PURCHASER ONLY, AND IS NOT TRANSFERABLE TO SUBSEQUENT OWNERS EXCEPT FOR EMISSION RELATED PARTS.** Repair parts and accessories replaced under this warranty are warranted only for the balance of the original unit or accessory warranty period. Any damage caused by improper installation or improper maintenance is not covered by this warranty. All parts or products replaced under warranty become the property of ECHO, Inc. This warranty is separate from the Emission control warranty statement supplied with your new product. Please consult the Emission Control Warranty Statement for details regarding emission related parts. For a list of Authorized ECHO Dealers refer to [WWW.ECHO-USA.COM](http://WWW.ECHO-USA.COM) or call **1-800-432-ECHO**.

### OWNER'S RESPONSIBILITY

To ensure trouble free warranty coverage it is important that you register your ECHO equipment on-line at [WWW.ECHO-USA.COM](http://WWW.ECHO-USA.COM) or by filling out the warranty registration card supplied with your unit. Registering your product confirms your warranty coverage and provides a direct link if we find it necessary to contact you.

The owner shall demonstrate reasonable care and use, and follow preventative maintenance, storage, fuel and oil usage as prescribed in the operator's manual. Should a product difficulty occur, you must, at your expense, deliver or ship your ECHO unit to an authorized ECHO servicing dealer for warranty repairs (within the applicable warranty period), and arrange for pick-up or return of your unit after the repairs have been made. For your nearest authorized ECHO servicing dealer, call ECHO's Dealer Referral Center, at 1-800-432-ECHO or you can locate an ECHO servicing dealer at [WWW.ECHO-USA.COM](http://WWW.ECHO-USA.COM). Should you require assistance or have questions concerning ECHO's Warranty Statement, you can contact our Consumer Product Support Department at 1-800-673-1558 or contact us through the web at [WWW.ECHO-USA.COM](http://WWW.ECHO-USA.COM).

### PRODUCT WARRANTY PERIOD

#### RESIDENTIAL APPLICATION

- **5 YEAR WARRANTY** - All units for residential, or non-income producing use will be covered by this limited warranty for **five (5) years** from date of purchase.

#### EXCEPTIONS:

- For two-stroke engine powered products, the electronic ignition module, flexible drive cables, SRM solid drive shafts, and TC tines are warranted for the **life\*** of the product on parts only.
- Cutting attachments such as, but not limited to, bars, chains, sprockets, blades, and nylon trimmer heads for residential or non-income producing use will be covered for failures due to defects in material or workmanship for a period of **60 days** from original product purchase date. Any misuse from contact with concrete, rocks, or other structures is not covered by this warranty.
- ECHO's Rapid Loader String Head carries a lifetime warranty on the line locking system, parts only; no labor. Refer to your operator's manual for string head installation and maintenance instructions.
- All SB-Series and PRO ATTACHMENT SERIES Split Shaft attachments carry the same warranty duration as the units they are designed to fit.

#### COMMERCIAL APPLICATION

- **1 YEAR WARRANTY** - All Chain Saws, QuikVent Saws, and Cut-Off Saws for commercial, institutional, agricultural, industrial, or income producing use will be covered by this limited warranty for one **(1) year** from the date of purchase.
- **2 YEAR WARRANTY** - All other units for commercial, institutional, agricultural, industrial, or income producing use will be covered by this limited warranty for two **(2) years** from the date of purchase.

#### EXCEPTIONS:

- For two-stroke engine powered products, the electronic ignition module, flexible drive cables, SRM solid drive shafts and TC tines, are warranted for the **life\*** of the product on parts only.
- Cutting attachments such as, but not limited to, bars, chains, sprockets, blades, and nylon trimmer heads for commercial, institutional, agricultural, industrial, rental, or income producing will be covered for failures due to defects in material or workmanship for a period of **30 days** from original product purchase date. Any misuse from contact with concrete, rocks, or other structures is not covered by this warranty.
- ECHO's Rapid Loader String Head carries a lifetime warranty on the line locking system, parts only; no labor. Refer to your operator's manual for string head installation and maintenance instructions.
- All SB-Series and PRO ATTACHMENT SERIES Split Shaft attachments carry the same warranty duration as the units they are designed to fit.

#### RENTAL APPLICATION - 90 DAYS WARRANTY

- Units for rental use will be covered against defects in material and workmanship for a period of 90 days from the date of purchase.

\* ECHO's liability under the "Lifetime" coverage is limited to furnishing parts specified under the PRODUCT WARRANTY PERIOD section of this warranty statement for "Life" free of charge for a period of ten (10) years after the date of the complete unit's final production.

#### **PURCHASED REPAIR PARTS, SHORT BLOCKS AND ACCESSORIES**

- 90-day residential, or non-income producing warranty
- 30-day commercial, institutional, agricultural, industrial, income producing, or rental application warranty

#### **ATTENTION TWO-STROKE ENGINE POWER PRODUCT OWNERS**

This ECHO two-stroke engine power product is a quality-engineered unit which has been manufactured to exact tolerances to provide superior performance. To help ensure the performance of the unit, it is required to use two-stroke oil which meets the ISO-L-EGD Standard per ISO/CD 13738 and JASO M345/FC/FD Standards. **ECHO Power Blend™ Two-Stroke Oil** is a premium two-stroke oil specifically formulated to meet ISO-L-EGD (ISO/CD 13738) and JASO M345/FC/FD Standards. The use of two-stroke oils designed for other applications, such as for outboard motors or lawnmowers can result in severe engine damage, and will void your two-stroke engine limited warranty.

#### **THIS WARRANTY DOES NOT COVER DAMAGE CAUSED BY:**

- Lack of lubrication or engine failure, due to the use of two-stroke oils that do not meet the ISO-L-EGD (ISO/CD 13738) and JASO M345/FC/FD Standards. Engine problems due to inadequate lubrication caused by failure to use an ISO-L-EGD compliant and JASO M345/FC/FD registered oil, will void the two-stroke engine limited warranty. **ECHO Power Blend™ Two-Stroke Oil** meets the ISO-L-EGD and JASO M345/FC/FD Standard. Emission related parts are covered for 5 years residential use or 2 years commercial use regardless of two-stroke oil used, per the statement listed in the EPA or California Emission Defect Warranty Explanation.
- Damage caused by use of gasohol, containing methanol (wood alcohol), or gasoline containing less than 89 octane. Only use gasoline which contains 89 octane or higher. Gasohol which contains a **maximum** 10% ethanol (grain alcohol) or 15% MTBE (methyl/tertiary/butyl/ether) is also approved. The prescribed mixing ratio of gasoline to oil is listed on the ECHO oil label and covered in your operator's manual.
- Engine damage caused by use of ether or any starting fluids.
- Damage caused by tampering with engine speed governor or emission components, or running engines above specified and recommended engine speeds as listed in your operator's manual.
- Operation of the unit with improperly maintained/removed cutting shield or removed/damaged air filter.
- Damage caused by dirt, pressure or steam cleaning the unit, salt water, corrosion, rust, varnish, abrasives, and moisture.
- Defects, malfunctions or failures resulting from abuse, misuse, neglect, modifications, alterations, normal wear, improper servicing, or use of unauthorized attachments.
- Incorrect storage procedures, stale fuel, including failure to provide or perform required maintenance services as prescribed in the operator's manual. Preventative maintenance as outlined in the operators manual is the customer's responsibility.
- Failures due to improper set-up, pre-delivery service or repair service by anyone other than authorized ECHO servicing dealer during the warranty period.
- Certain parts and other items are not warranted, including but not limited to: lubricants, starter cords, and engine tune-ups.
- Use of spark plugs other than those meeting performance and durability requirements of the OEM spark plug listed in the Operator's Manuals.
- Overheating or carbon scoring failures due to restricted, clogged exhaust port or combustion chamber, including damage to spark arrester screen.
- Adjustments after the first (30) thirty days and beyond, such as carburetor adjustment and throttle cable adjustment.
- Damage to gears or gear cases caused by contaminated grease or oil, use of incorrect type or viscosity of lubricants, and/or failure to comply with recommended grease or oil change intervals.
- Damage caused by loading SHRED 'N' VAC® beyond recommended capacity.
- Damage caused by pump or sprayer running dry, pumping or spraying caustic or flammable materials, or lack of or broken strainers.
- Additional damage to parts or components due to continued use after operational problem or failure occurs. Should operational problem or failure occur, the product should not be used, but delivered as is to an authorized ECHO servicing dealer.

It is a dealer's and/or customer's responsibility to complete and return the warranty registration card supplied with your ECHO product or by visiting [WWW.ECHO-USA.COM](http://WWW.ECHO-USA.COM). Your receipt of purchase including date, model and serial number must be maintained and presented to an authorized ECHO servicing dealer for warranty service. Proof of purchase rests solely with the customer. Some states do not allow limitations on how long an implied warranty lasts, so the above limitations may not apply to you. Some states do not allow the exclusion or limitation of incidental or consequential damages, so you may also have other specific legal rights which vary from state to state. This limited warranty is given by ECHO Incorporated, 400 Oakwood Rd., Lake Zurich, IL 60047.

#### **DISCLAIMER OF IMPLIED WARRANTIES**

This limited warranty is in lieu of all other expressed or implied warranties, including any warranty of FITNESS FOR A PARTICULAR PURPOSE OR USE and any implied warranty of **MERCHANTABILITY** otherwise applicable to this product. ECHO and its affiliated companies shall not be liable for any special incidental or consequential damage, including lost profits. There are no warranties extended other than as provided herein. This limited warranty may be modified only by ECHO.

**99922201032**  
**12/03/09**

**ECHO INCORPORATED EMISSION CONTROL WARRANTY STATEMENT  
FOR ECHO AND SHINDAIWA BRANDS**

The Environmental Protection Agency (EPA) and the California Air Resources Board (C.A.R.B.) and ECHO Incorporated (ECHO Inc.) are pleased to explain the emission control system warranty on your 2010 and later equipment/small off-road engine (SORE). New equipment/SORE must be designed, built and equipped to meet stringent EPA and C.A.R.B. anti-smog standards. ECHO Inc. must warrant the emission control system on your equipment/SORE for the periods of time listed below, provided there has been no abuse, neglect or improper maintenance of your equipment/SORE. Your emission control system may include parts such as: carburetor, fuel-injection system, ignition system, catalytic converter/muffler, fuel tank, fuel feed lines, fuel cap assembly, spark plug, air filters, and other associated components. Where a warrantable condition exists, ECHO Inc will repair your equipment/SORE at no cost to you including diagnosis, parts and labor. The Emission Control System warranty is extended to the original owner including all subsequent owners.

**MANUFACTURER'S WARRANTY COVERAGE:**

The emission control system is warranted for 2 years or the length of the ECHO Inc. warranty, whichever is longer. If any emission-related part on your equipment is defective, the part will be repaired or replaced by ECHO Inc. or its Authorized Service Representative.

**OWNER'S WARRANTY RESPONSIBILITIES:**

As the equipment/SORE owner, you are responsible for the performance of the required maintenance listed in your Operator's Manual. ECHO Inc. recommends that you retain all receipts covering maintenance on your equipment/SORE however, ECHO Inc. cannot deny warranty solely for the lack of receipts or for your failure to ensure the performance of all scheduled maintenance. As the equipment/SORE owner, you should be aware that ECHO Inc. may deny you warranty coverage if your equipment/SORE or a part has failed due to abuse, neglect, improper maintenance or unapproved modifications.

You are responsible for presenting your equipment/SORE to an ECHO Inc. authorized service representative as soon as a problem exists. The warranty repairs should be completed in a reasonable amount of time, not to exceed 30 days. If a warrantable condition exists and there is no Authorized Dealer within 100 miles, ECHO Inc. will pay to ship the unit to the nearest authorized dealer. If you have questions regarding your warranty coverage, you should contact ECHO Inc. at 1-800-673-1558, web site WWW.ECHO-USA.COM or contact Shindaiwa at 1-877-986-7783, web site WWW.SHINDAIWA.COM.

**WHAT DOES THIS WARRANTY COVER?**

ECHO Inc. warrants that your equipment/SORE was designed, built and equipped to conform with applicable EPA and C.A.R.B. emissions standards and that your equipment/SORE is free from defects in material and workmanship that would cause it to fail to conform with applicable requirements for 2 years or the length of the ECHO Inc. warranty, whichever is longer. The warranty period begins on the date the product is purchased by an end user.

**HOW WILL A COVERED PART BE CORRECTED?**

If there is a defect in a part covered by this warranty, any ECHO Inc. Authorized Service Dealer will correct the defect. You will not have to pay anything to have the part adjusted, repaired or replaced. This includes any labor and diagnosis for warranted repairs performed by the dealer. In addition, engine parts not expressly covered under this warranty but whose failure is a result of a failure of a covered part will be warranted.

**WHAT PARTS ARE COVERED?**

Any applicable emission related part not scheduled for "required maintenance" will be repaired or replaced within the warranty period. The repaired or replaced part will be warranted for the remaining ECHO Inc. warranty period.

Any warranted part that is scheduled only for regular inspection in the written instructions supplied is warranted for the warranty period stated above. Any such part repaired or replaced under warranty will be warranted for the remaining ECHO Inc. warranty period.

Any emission related part scheduled for replacement during "required maintenance" is warranted for the period of time prior to the first scheduled replacement point for that part. Any such part repaired or replaced under warranty shall be warranted for the remainder of the period prior to the first scheduled replacement point for that part.

Any manufacturer-approved replacement part may be used in the performance of any warranty maintenance or repairs on emission related parts, and must be provided without charge if the part is still under warranty.

Any replacement part that is equivalent in performance and durability may be used in non-warranty maintenance or repairs, and shall not reduce the warranty obligations of the manufacturer.

Throughout the equipment/SORE warranty period, ECHO Inc. will maintain a supply of warranted parts sufficient to meet the expected demand for such parts.

**SPECIFIC EMISSION RELATED WARRANTED PARTS:**

- |  |   |
|--|---|
| • Electronic Ignition System             | • Spark Plug  |
| • Catalytic Converter / Muffler Assembly | • Carburetor (complete assembly or replaceable components)        |
| • Choke                                  | • Fuel-Injection Assembly (or replaceable components)             |
| • Fuel Tank                              | • Fuel Cap Assembly   |
| • Air Filter                             | • Fuel Feed Line (and associated clamps/connectors as applicable) |

**WHAT IS NOT COVERED?**

Any failure caused by abuse, neglect, improper maintenance, unapproved modifications, use of unapproved add-on parts/modified parts or unapproved accessories.

This Emission Control Warranty is valid only for the U.S.A., it's Territories, and Canada.

**99922201033  
01/2010**

## SERVICING INFORMATION

### PARTS/SERIAL NUMBER

Genuine ECHO Parts and ECHO REPOWER™ Parts and Assemblies for your ECHO products are available only from an Authorized ECHO Dealer. When you do need to buy parts **always** have the Model Number, Type and Serial Number of the unit with you. You can find these numbers on the engine housing. For future reference, write them in the space provided below.

Model No. \_\_\_\_\_ Type \_\_\_\_\_ SN. \_\_\_\_\_

### SERVICE

Service of this product during the warranty period must be performed by an Authorized ECHO Service Dealer. For the name and address of the Authorized ECHO Service Dealer nearest you, ask your retailer or call: 1-800-432-ECHO (3246). Dealer information is also available on our Web Site. When presenting your unit for Warranty service/repairs, proof of purchase is required.

### ECHO CONSUMER PRODUCT SUPPORT

If you require assistance or have questions concerning the application, operation or maintenance of this product you may call the ECHO Consumer Product Support Department at 1-800-673-1558 from 8:30 am to 4:30 pm (Central Standard Time) Monday through Friday. Before calling, please know the model and serial number of your unit.

### WARRANTY REGISTRATION

To ensure trouble free warranty coverage it is important that you register your ECHO equipment on-line at [www.echo-usa.com](http://www.echo-usa.com) or filling out the warranty registration card supplied with your unit. Registering your product confirms your warranty coverage and provides a direct link between you and ECHO if we find it necessary to contact you.

### ADDITIONAL OR REPLACEMENT MANUALS

**Replacement Operator, Safety Manuals, and Parts Catalogs** are available from your ECHO dealer or at [www.echo-usa.com](http://www.echo-usa.com) or by contacting ECHO Inc., 400 Oakwood Road, Lake Zurich, IL 60047 (800-673-1558). Always check the ECHO Web Site for updated information.

**Safety Videos** are available from your Echo dealer. A \$5.00 shipping charge will be required for each video.

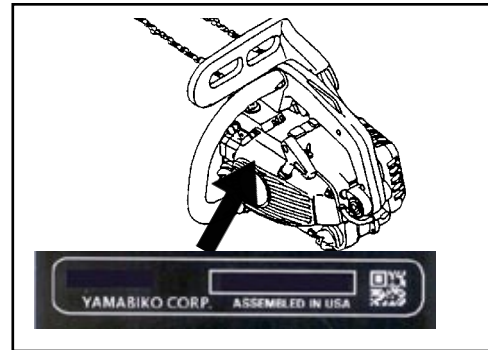

**DEALER? Call**  
**1-800-432-ECHO**  
**1-800-432-3246**  
or  
**[www.echo-usa.com](http://www.echo-usa.com)**

**CONSUMER PRODUCT**  
**SUPPORT**  
**1-800-673-1558**  
**8:30 - 4:30 Mon - Fri C.S.T.**

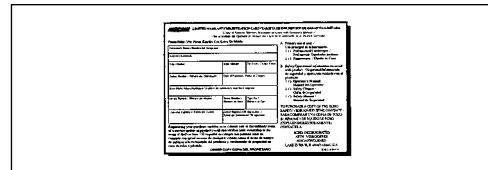

# **ECHO**

**ECHO, INCORPORATED**

400 OAKWOOD ROAD

LAKE ZURICH, IL 60047-1564

**[www.echo-usa.com](http://www.echo-usa.com)**

360T C04412001001/C04412999999

360T C07811001001/C07811999999

330T C04212001001/C04212999999

330T C07711001001/C07711999999