

# 14" Variable Speed Wood Lathe (46-715)



PART NO. 903742 - 03-18-05  
Copyright © 2005 Delta Machinery

INSTRUCTION MANUAL



To learn more about DELTA MACHINERY  
visit our website at: [www.deltamachinery.com](http://www.deltamachinery.com).

For Parts, Service, Warranty or other Assistance,

please call **1-800-223-7278** (In Canada call **1-800-463-3582**).

# TABLE OF CONTENTS

IMPORTANT SAFETY INSTRUCTIONS .....	.2
SAFETY GUIDELINES .....	.3
GENERAL SAFETY RULES .....	.4
ADDITIONAL SPECIFIC SAFETY RULES .....	.5
FUNCTIONAL DESCRIPTION .....	.7
CARTON CONTENTS .....	.7
ASSEMBLY .....	.8
OPERATION .....	.10
TROUBLESHOOTING .....	.19
MAINTENANCE .....	.19
SERVICE .....	.20
ACCESSORIES .....	.21
WARRANTY .....	.22
SERVICE CENTER LOCATIONS .....	.back cover

## IMPORTANT SAFETY INSTRUCTIONS

**▲WARNING** Read and understand all warnings and operating instructions before using any tool or equipment. When using tools or equipment, basic safety precautions should always be followed to reduce the risk of personal injury. Improper operation, maintenance or modification of tools or equipment could result in serious injury and property damage. There are certain applications for which tools and equipment are designed. Delta Machinery strongly recommends that this product NOT be modified and/or used for any application other than for which it was designed.

If you have any questions relative to its application DO NOT use the product until you have written Delta Machinery and we have advised you.

Online contact form at [www.deltamachinery.com](http://www.deltamachinery.com)

Postal Mail: Technical Service Manager  
Delta Machinery  
4825 Highway 45 North  
Jackson, TN 38305

Information regarding the safe and proper operation of this tool is available from the following sources:

Power Tool Institute  
1300 Sumner Avenue, Cleveland, OH 44115-2851  
[www.powertoolinstitute.org](http://www.powertoolinstitute.org)

National Safety Council  
1121 Spring Lake Drive, Itasca, IL 60143-3201

American National Standards Institute, 25 West 43rd Street, 4 floor, New York, NY 10036 [www.ansi.org](http://www.ansi.org)  
ANSI 01.1 Safety Requirements for Woodworking Machines, and

the U.S. Department of Labor regulations [www.osha.gov](http://www.osha.gov)

**SAVE THESE INSTRUCTIONS!**

# SAFETY GUIDELINES - DEFINITIONS

It is important for you to read and understand this manual. The information it contains relates to protecting YOUR SAFETY and PREVENTING PROBLEMS. The symbols below are used to help you recognize this information.



- ▲ DANGER** Indicates an imminently hazardous situation which, if not avoided, will result in death or serious injury.
- ▲ WARNING** Indicates a potentially hazardous situation which, if not avoided, could result in death or serious injury.
- ▲ CAUTION** Indicates a potentially hazardous situation which, if not avoided, may result in minor or moderate injury.
- CAUTION** Used without the safety alert symbol indicates potentially hazardous situation which, if not avoided, may result in property damage.

---

## CALIFORNIA PROPOSITION 65

**▲ WARNING** **SOME DUST CREATED BY POWER SANDING, SAWING, GRINDING, DRILLING, AND OTHER CONSTRUCTION ACTIVITIES** contains chemicals known to cause cancer, birth defects or other reproductive harm. Some examples of these chemicals are:

- lead from lead-based paints,
- crystalline silica from bricks and cement and other masonry products, and
- arsenic and chromium from chemically-treated lumber.

Your risk from these exposures varies, depending on how often you do this type of work. To reduce your exposure to these chemicals: work in a well ventilated area, and work with approved safety equipment, always wear **NIOSH/OSHA** approved, properly fitting face mask or respirator when using such tools.

# GENERAL SAFETY RULES



**⚠ WARNING** READ AND UNDERSTAND ALL WARNINGS AND OPERATING INSTRUCTIONS BEFORE USING THIS EQUIPMENT. Failure to follow all instructions listed below, may result in electric shock, fire, and/or serious personal injury or property damage.

## IMPORTANT SAFETY INSTRUCTIONS

- FOR YOUR OWN SAFETY, READ THE INSTRUCTION MANUAL BEFORE OPERATING THE MACHINE.** Learning the machine's application, limitations, and specific hazards will greatly minimize the possibility of accidents and injury.
- WEAR EYE AND HEARING PROTECTION. ALWAYS USE SAFETY GLASSES.** Everyday eyeglasses are NOT safety glasses. USE CERTIFIED SAFETY EQUIPMENT. Eye protection equipment should comply with ANSI Z87.1 standards. Hearing equipment should comply with ANSI S3.19 standards.
- WEAR PROPER APPAREL.** Do not wear loose clothing, gloves, neckties, rings, bracelets, or other jewelry which may get caught in moving parts. Nonslip footwear is recommended. Wear protective hair covering to contain long hair.
- DO NOT USE THE MACHINE IN A DANGEROUS ENVIRONMENT.** The use of power tools in damp or wet locations or in rain can cause shock or electrocution. Keep your work area well-lit to prevent tripping or placing arms, hands, and fingers in danger.
- MAINTAIN ALL TOOLS AND MACHINES IN PEAK CONDITION.** Keep tools sharp and clean for best and safest performance. Follow instructions for lubricating and changing accessories. Poorly maintained tools and machines can further damage the tool or machine and/or cause injury.
- CHECK FOR DAMAGED PARTS.** Before using the machine, check for any damaged parts. Check for alignment of moving parts, binding of moving parts, breakage of parts, and any other conditions that may affect its operation. A guard or any other part that is damaged **should be properly repaired or replaced.** Damaged parts can cause further damage to the machine and/or injury.
- KEEP THE WORK AREA CLEAN.** Cluttered areas and benches invite accidents.
- KEEP CHILDREN AND VISITORS AWAY.** Your shop is a potentially dangerous environment. Children and visitors can be injured.
- REDUCE THE RISK OF UNINTENTIONAL STARTING.** Make sure that the switch is in the "OFF" position before plugging in the power cord. In the event of a power failure, move the switch to the "OFF" position. An accidental start-up can cause injury.
- USE THE GUARDS.** Check to see that all guards are in place, secured, and working correctly to reduce the risk of injury.
- REMOVE ADJUSTING KEYS AND WRENCHES BEFORE STARTING THE MACHINE.** Tools, scrap pieces, and other debris can be thrown at high speed, causing injury.
- USE THE RIGHT MACHINE.** Don't force a machine or an attachment to do a job for which it was not designed. Damage to the machine and/or injury may result.
- USE RECOMMENDED ACCESSORIES.** The use of accessories and attachments not recommended by Delta may cause damage to the machine or injury to the user.
- USE THE PROPER EXTENSION CORD.** Make sure your extension cord is in good condition. When using an extension cord, be sure to use one heavy enough to carry the current your product will draw. An undersized cord will cause a drop in line voltage, resulting in loss of power and overheating. See the Extension Cord Chart for the correct size depending on the cord length and nameplate ampere rating. If in doubt, use the next heavier gauge. The smaller the gauge number, the heavier the cord.
- SECURE THE WORKPIECE.** Use clamps or a vise to hold the workpiece when practical. Loss of control of a workpiece can cause injury.
- FEED THE WORKPIECE AGAINST THE DIRECTION OF THE ROTATION OF THE BLADE, CUTTER, OR ABRASIVE SURFACE.** Feeding it from the other direction will cause the workpiece to be thrown out at high speed.
- DON'T FORCE THE WORKPIECE ON THE MACHINE.** Damage to the machine and/or injury may result.
- DON'T OVERREACH.** Loss of balance can make you fall into a working machine, causing injury.
- NEVER STAND ON THE MACHINE.** Injury could occur if the tool tips, or if you accidentally contact the cutting tool.
- NEVER LEAVE THE MACHINE RUNNING UNATTENDED. TURN THE POWER OFF.** Don't leave the machine until it comes to a complete stop. A child or visitor could be injured.
- TURN THE MACHINE "OFF", AND DISCONNECT THE MACHINE FROM THE POWER SOURCE** before installing or removing accessories, before adjusting or changing set-ups, or when making repairs. An accidental start-up can cause injury.
- MAKE YOUR WORKSHOP CHILDPROOF WITH PADLOCKS, MASTER SWITCHES, OR BY REMOVING STARTER KEYS.** The accidental start-up of a machine by a child or visitor could cause injury.
- STAY ALERT, WATCH WHAT YOU ARE DOING, AND USE COMMON SENSE. DO NOT USE THE MACHINE WHEN YOU ARE TIRED OR UNDER THE INFLUENCE OF DRUGS, ALCOHOL, OR MEDICATION.** A moment of inattention while operating power tools may result in injury.
- ⚠ WARNING** USE OF THIS TOOL CAN GENERATE AND DISBURSE DUST OR OTHER AIRBORNE PARTICLES, INCLUDING WOOD DUST, CRYSTALLINE SILICA DUST AND ASBESTOS DUST. Direct particles away from face and body. Always operate tool in well ventilated area and provide for proper dust removal. Use dust collection system wherever possible. Exposure to the dust may cause serious and permanent respiratory or other injury, including silicosis (a serious lung disease), cancer, and death. Avoid breathing the dust, and avoid prolonged contact with dust. Allowing dust to get into your mouth or eyes, or lay on your skin may promote absorption of harmful material. Always use properly fitting NIOSH/OSHA approved respiratory protection appropriate for the dust exposure, and wash exposed areas with soap and water.

# ADDITIONAL SAFETY RULES FOR WOOD LATHES

**⚠ WARNING** FAILURE TO FOLLOW THESE RULES MAY RESULT IN SERIOUS INJURY.

1. **DO NOT OPERATE THIS MACHINE UNTIL** it is assembled and installed according to the instructions.
2. **OBTAIN ADVICE** from your supervisor, instructor, or another qualified person if you are not familiar with the operation of this machine.
3. **FOLLOW ALL WIRING CODES** and recommended electrical connections.
4. **ROUGH CUT THE WORKPIECE** as close as possible to the finished shape before installing it on the faceplate.
5. **EXAMINE THE WORKPIECE FOR FLAWS** and test glue joints before mounting the workpiece on machine. DO NOT mount a split workpiece or one containing a knot.
6. **SECURELY FASTEN THE WORKPIECE** to the faceplate prior to faceplate turning. Use the appropriate size faceplate to properly support the workpiece. Do not let the screw fasteners interfere with the turning tool at the finished dimension of the workpiece.
7. **NEVER DRIVE THE WORKPIECE** into the drive center while the drive center is in the headstock. Set the drive center into the workpiece with a soft mallet prior to installing it on the headstock.
8. **SNUG THE TAILSTOCK CENTER** against the workpiece and lock it. Lubricate the tailstock center if it is not a ball bearing center.
9. **PROPERLY ADJUST THE TOOL REST HEIGHT.**
10. **ADJUST THE TOOL REST** so it is as close to the workpiece as possible.
11. **TIGHTEN ALL CLAMP LOCKING HANDLES** before operating.
12. **ROTATE THE WORKPIECE BY HAND** to check clearance before turning the machine "ON".
13. **CLEAR THE LATHE BED OF ALL OBJECTS** (tools, scraps of wood, etc.) before turning the machine "ON".
14. **EXAMINE THE SET-UP CAREFULLY** before turning the machine "ON".
15. **STAND CLEAR, AND KEEP ALL OBSERVERS AND PASSERSBY** clear of rotating path of workpiece to avoid injury from flying debris.
16. **USE THE LOWEST SPEED** when starting a new workpiece. NEVER EXCEED recommended speeds.
17. **NEVER ADJUST THE TOOL REST** while the workpiece is turning.
18. **NEVER LOOSEN THE TAILSTOCK SPINDLE** or the tailstock while workpiece is turning.
19. **MOVE THE CUTTING TOOL INTO THE WORKPIECE SLOWLY**, and cut small amounts when roughing.
20. **REMOVE THE TOOL REST** before sanding or polishing.
21. **NEVER PERFORM LAYOUT**, assembly, or set-up work on the table/work area when the machine is running.
22. **TURN THE MACHINE "OFF" AND DISCONNECT THE MACHINE** from the power source before installing or removing accessories, before adjusting or changing set-ups, or when making repairs.
23. **TURN THE MACHINE "OFF"**, disconnect the machine from the power source, and clean the table/work area before leaving the machine. **LOCK THE SWITCH IN THE "OFF" POSITION** to prevent unauthorized use.
24. **ADDITIONAL INFORMATION** regarding the safe and proper operation of power tools (i.e. a safety video) is available from the Power Tool Institute, 1300 Sumner Avenue, Cleveland, OH 44115-2851 ([www.powertoolinstitute.com](http://www.powertoolinstitute.com)). Information is also available from the National Safety Council, 1121 Spring Lake Drive, Itasca, IL 60143-3201. Please refer to the American National Standards Institute ANSI 01.1 Safety Requirements for Woodworking Machines and the U.S. Department of Labor OSHA 1910.213 Regulations.

## SAVE THESE INSTRUCTIONS.

Refer to them often and use them to instruct others.

## POWER CONNECTIONS

A separate electrical circuit should be used for your machines. This circuit should not be less than #12 wire and should be protected with a 20 Amp time lag fuse. If an extension cord is used, use only 3-wire extension cords which have 3-prong grounding type plugs and matching receptacle which will accept the machine's plug. Before connecting the machine to the power line, make sure the switch (s) is in the "OFF" position and be sure that the electric current is of the same characteristics as indicated on the machine. All line connections should make good contact. Running on low voltage will damage the machine.

**⚠ DANGER** DO NOT EXPOSE THE MACHINE TO RAIN OR OPERATE THE MACHINE IN DAMP LOCATIONS.

## MOTOR SPECIFICATIONS

Your machine is wired for 110-120 volt, 50/60 HZ alternating current. Before connecting the machine to the power source, make sure the switch is in the "OFF" position.

# GROUNDING INSTRUCTIONS

**⚠ DANGER** This machine must be grounded while in use to protect the operator from electric shock.

## 1. All grounded, cord-connected machines:

In the event of a malfunction or breakdown, grounding provides a path of least resistance for electric current to reduce the risk of electric shock. This machine is equipped with an electric cord having an equipment-grounding conductor and a grounding plug. The plug must be plugged into a matching outlet that is properly installed and grounded in accordance with all local codes and ordinances.

Do not modify the plug provided - if it will not fit the outlet, have the proper outlet installed by a qualified electrician.

Improper connection of the equipment-grounding conductor can result in risk of electric shock. The conductor with insulation having an outer surface that is green with or without yellow stripes is the equipment-grounding conductor. If repair or replacement of the electric cord or plug is necessary, do not connect the equipment-grounding conductor to a live terminal.

Check with a qualified electrician or service personnel if the grounding instructions are not completely understood, or if in doubt as to whether the machine is properly grounded.

Use only 3-wire extension cords that have 3-prong grounding type plugs and matching 3-conductor receptacles that accept the machine's plug, as shown in Fig. A.

Repair or replace damaged or worn cord immediately.

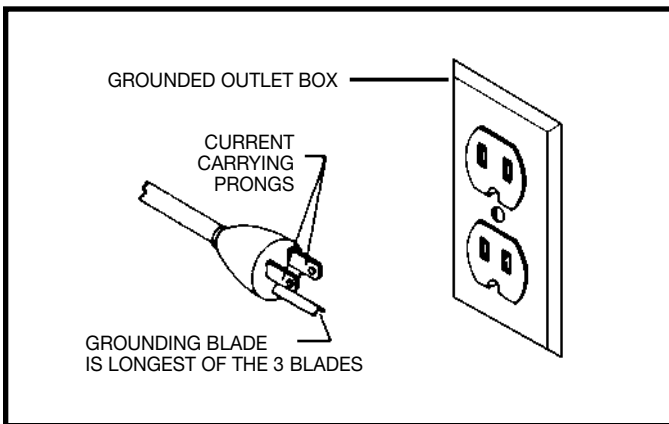

Fig. A

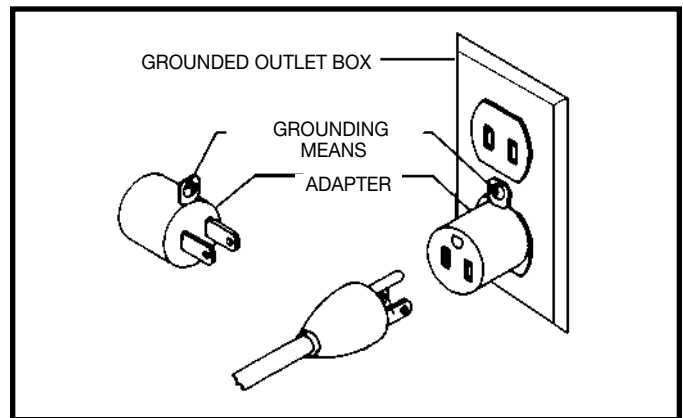

Fig. B

**NOTE:** In Canada, the use of a temporary adapter is not permitted by the Canadian Electric Code.

**⚠ DANGER** IN ALL CASES, MAKE CERTAIN THAT THE RECEPTACLE IN QUESTION IS PROPERLY GROUNDED. IF YOU ARE NOT SURE, HAVE A QUALIFIED ELECTRICIAN CHECK THE RECEPTACLE.

## EXTENSION CORDS

**⚠ WARNING** Use proper extension cords. Make sure your extension cord is in good condition and is a 3-wire extension cord which has a 3-prong grounding type plug and matching receptacle which will accept the machine's plug. When using an extension cord, be sure to use one heavy enough to carry the current of the machine. An undersized cord will cause a drop in line voltage, resulting in loss of power and overheating. Fig. D-1 shows the correct gauge to use depending on the cord length. If in doubt, use the next heavier gauge. The smaller the gauge number, the heavier the cord.

MINIMUM GAUGE EXTENSION CORD			
RECOMMENDED SIZES FOR USE WITH STATIONARY ELECTRIC MACHINES			
Ampere Rating	Volts	Total Length of Cord in Feet	Gauge of Extension Cord
0-6	120	up to 25	18 AWG
		25-50	16 AWG
		50-100	16 AWG
		100-150	14 AWG
6-10	120	up to 25	18 AWG
		25-50	16 AWG
		50-100	14 AWG
		100-150	12 AWG
10-12	120	up to 25	16 AWG
		25-50	16 AWG
		50-100	14 AWG
		100-150	12 AWG
12-16	120	up to 25	14 AWG
		25-50	12 AWG
		GREATER THAN 50 FEET NOT RECOMMENDED	

Fig. D-1

# FUNCTIONAL DESCRIPTION

## FOREWORD

The Delta 46-715 14" adjustable speed wood lathe is a big capacity lathe, designed for industry, commercial shops, and schools.

**NOTICE:** The photo on the manual cover illustrates the current production model. All other illustrations contained in the manual are representative only and may not depict the actual color, labeling, or accessories and are intended to illustrate technique only.

## UNPACKING AND CLEANING

Carefully unpack the machine and all loose items from the shipping container(s). Remove the protective coating from all unpainted surfaces. This coating may be removed with a soft cloth moistened with kerosene (do not use acetone, gasoline or lacquer thinner for this purpose). After cleaning, cover the unpainted surfaces with a good quality household floor paste wax.

## CARTON CONTENTS

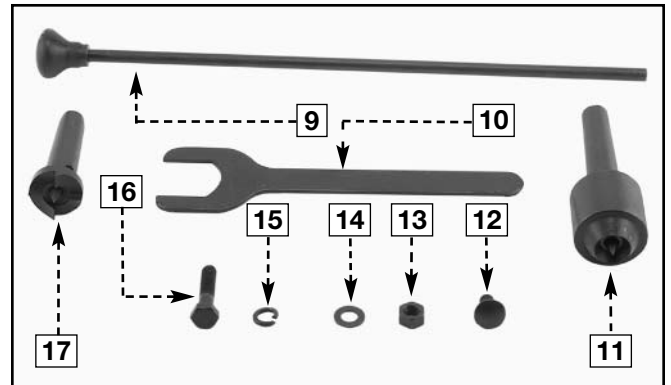
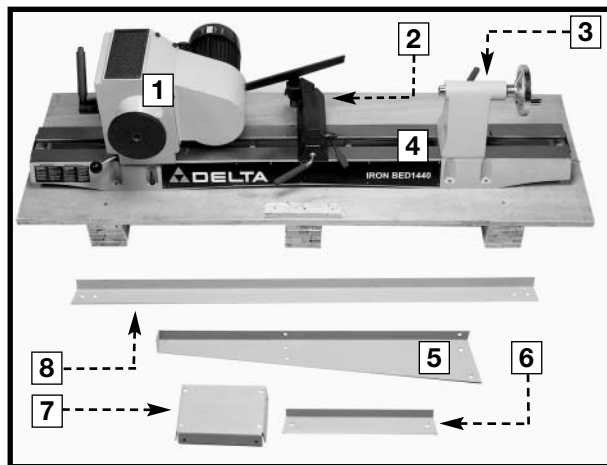

1. Headstock Assembly
2. Tool Rest Assembly
3. Tailstock Assembly
4. Lathe Bed
5. Leg (4)
6. Short Tie Bar (2)
7. Stand Top (2)
8. Long Tie Bar (2)
9. Knockout Bar

10. Spindle Wrench
11. Live Center
12. M8 x 16mm Carriage Bolts (24)
13. Nuts (32)
14. Flat Washers (32)
15. Lockwashers (32)
16. M8 x 35mm Hex Head Screws (8)
17. Drive Center

## ASSEMBLY

### ASSEMBLY TOOLS REQUIRED

Assembly for this tool will require a phillips-head screwdriver and an adjustable wrench.

### ASSEMBLY TIME ESTIMATE

Assembly for this tool should take approximately 1 to 2 hours.

## ASSEMBLING THE STAND

1. Attach the two long tie bars (A) Fig. 3 (with the flanges up) to the center of each stand leg (B) by using eight carriage bolts through the legs and tie bars, secured by flat washers, lockwashers, and hex nuts.

**NOTE:** Hand-tighten the hardware for further adjustment.

2. Attach two short tie bars (C) Fig. 3 (with the flanges up), to each leg (B), using eight carriage bolts through the legs and tie bars, secured by flat washers, lock-washers, and hex nuts.
3. Attach the two stand tops (D) Fig. 3 to the inside of the top of the stand legs (B) using twelve carriage bolts through the leg, then through the stand top. Secure with flat washers, lockwashers, and hex nuts.

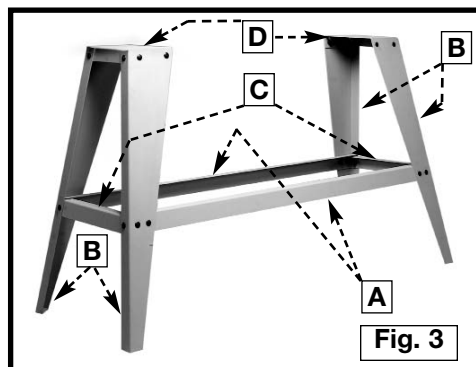

## ATTACHING THE LATHE BED TO THE STAND

The 46-715 lathe comes attached to plywood. To attach the lathe bed to the stand:

1. Remove the security bars (A) Fig. 4 that are attached to both ends of the lathe bed by removing the two screws (B) Fig. 4 that secure it.

**CAUTION** The headstock is very heavy. Have someone help remove it from the lathe bed.

3. Loosen the lock handle (C) Fig. 5 and slide the headstock off the end of the lathe bed.
4. Loosen the lock handle (D) Fig. 6 and slide the tool rest off the end of the lathe bed.
5. Loosen the lock handle (E) Fig. 7 and slide the tailstock off the end of the lathe bed.
6. Remove the two bolts (one is shown at (F) Fig. 8) to free the lathe bed from the plywood.

**CAUTION** The lathe bed is heavy. Have someone help lift it on the stand.

8. Position the lathe bed so that the holes in the lathe bed are directly above the holes in the stand.
9. Secure the lathe bed to the stand using the eight M8 x 35mm Hex head screws (G) Fig. 9 through the lathe bed and through the stand. Attach a washer, lockwasher, and nut and tighten securely.
10. Before tightening all hardware, press down on stand until legs adjust to floor surface. Securely tighten all hardware.
11. Slide the tool rest and tailstock back into the lathe bed.
12. Have someone help lift the headstock on the lathe bed and slide it into position.

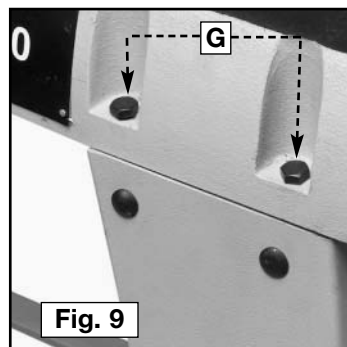
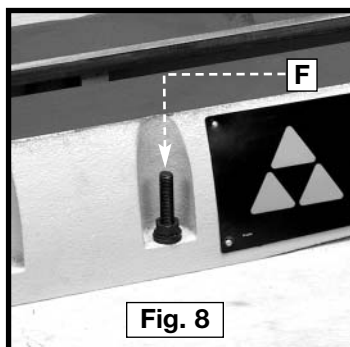
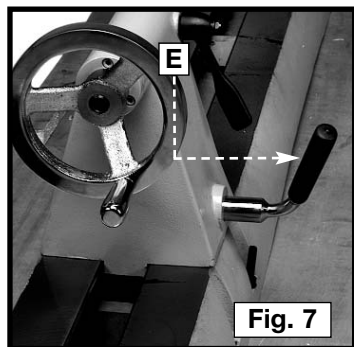
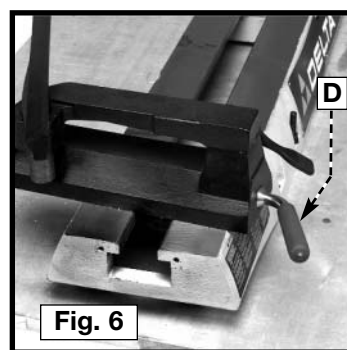
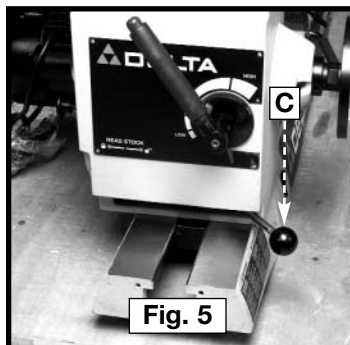
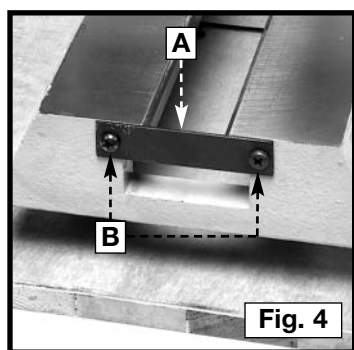



## HEADSTOCK SPUR CENTER

The 46-715 comes with a faceplate attached. Before inserting the spur center in the spindle, remove this faceplate. Insert the knockout bar (A) Fig. 10 in the side hole of the spindle (B) Fig. 10 to hold the spindle in place. Use the supplied wrench (C) Fig. 10 to loosen the faceplate. Remove the faceplate (D) by turning it counter-clockwise with your hand. The spur center (A) Fig. 11 is equipped with a No. 2 Morse Taper shank. Insert this shank into the headstock spindle (B).

**NOTE:** Before inserting the spur center (A), clean both the shank of the spur center and the inside of the headstock spindle to remove any grease or debris. To remove the tapered shank spur center (A) Fig. 11 from the headstock spindle (B) Fig. 11, use the knockout bar (C) Fig. 12 through the hole (D) in the opposite end of the spindle to push the spur center out.

**IMPORTANT:** Never drive the workpiece into the spur center when it is mounted in the headstock.

See instructions on setting the spur center into the workpiece in the “OPERATION” section of this manual under “CENTERING THE WORK.”

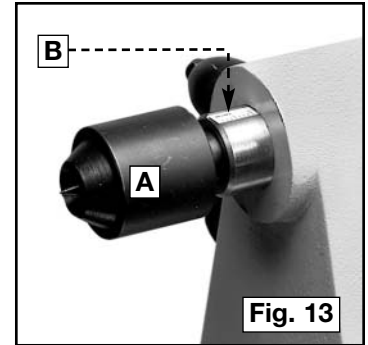
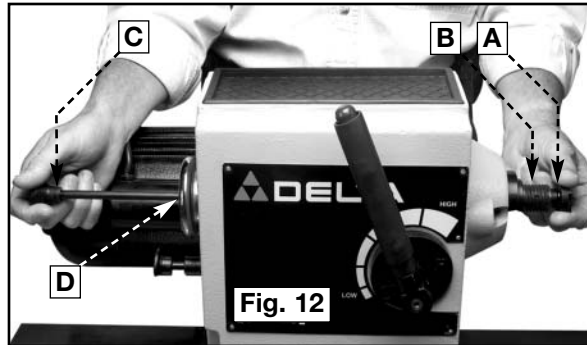
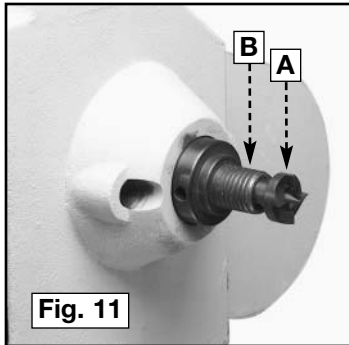
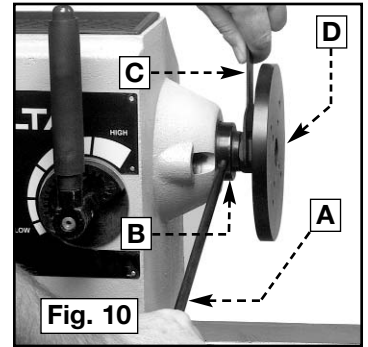

## TAILSTOCK LIVE CENTER

The tailstock live center (A) Fig. 13, supplied with your lathe, is equipped with a No. 2 Morse Taper shank.

**NOTE:** Before inserting the live center, clean both the shank and the inside of the tailstock to remove any grease or debris. To remove the live center (A) from the tailstock spindle (B), use the knockout bar (C) Fig. 12 (supplied) through the hole (D) in the opposite end of the spindle.

## ADJUSTING CLAMPS ON THE HEADSTOCK AND TAILSTOCK

The headstock and tailstock can be moved along the lathe bed. A downward push on the handle (A) Fig. 14 locks the mechanism, while an upward movement of the handle releases the securing action. The clamps are pre-set at the factory. However, should either need adjusting, use an 11/16” wrench to slightly loosen or tighten the nut (A) Fig. 16 on the tailstock.

**NOTE:** Clamp the headstock and tailstock firmly while operating the lathe.

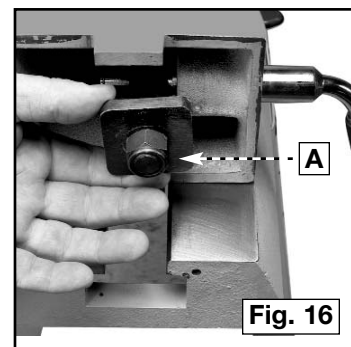
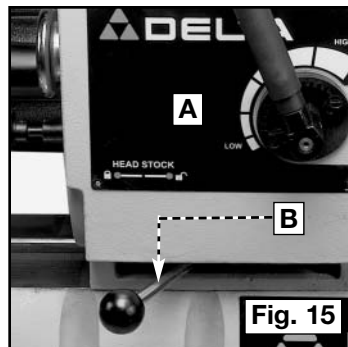
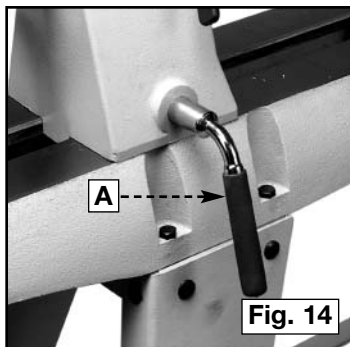

## TOOL REST

The tool rest (A) and tool rest base (B) are shown in Fig. 17. To position the tool rest on the lathe bed, lift the clamp handle (C), move the tool rest base and lock it in place by pushing down on the handle (C). To adjust the tool rest (A) for the correct height, loosen the locking lever (D), move the tool rest (A) up or down and tighten the locking lever (D).

**NOTE:** The locking lever (D) Fig. 17 can be positioned on the left or right side of the tool rest base (B). To reposition the tool rest locking lever (D), unscrew the lever counterclockwise. A threaded hole is provided in the left side of tool rest base (B) to accept the locking lever (D).

**NOTE:** Clamp the tool rest firmly while operating the lathe.

## ADJUSTING CLAMP ON TOOL REST

To adjust the tool rest clamping action, use a 15/16" wrench to adjust the nut (A) Fig. 16 in the same manner as the headstock and tailstock.

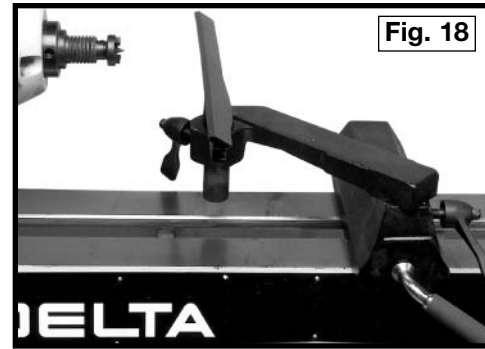
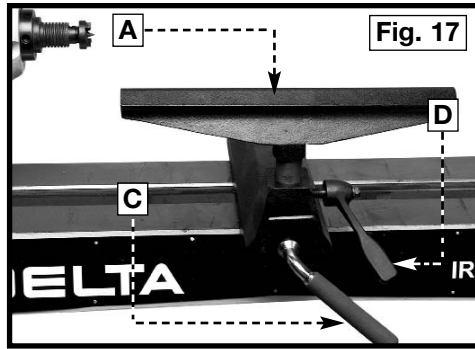

## ATTACHING ON/OFF SWITCH TO TOOL

The "ON/OFF" switch comes unattached to the tool to protect it from damage in shipping. To attach the "ON/OFF" Switch:

1. Remove the two hex bolts (A) Fig. 19 that are attached to the back of the headstock, located near the top.
2. Align the two holes in the bottom of the "ON/OFF" switch with the two holes where the hex bolts were removed in **STEP 1**.
3. Secure the "ON/OFF" switch to the headstock with the bolts that were removed in **STEP 1** (Fig. 20).

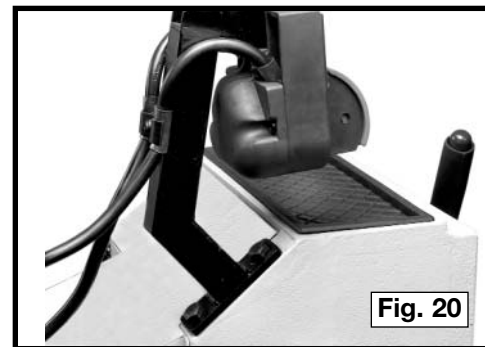
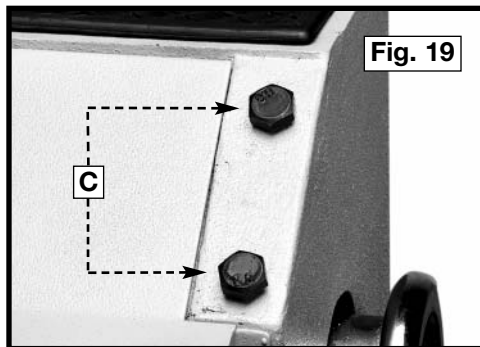

# OPERATION

## OPERATIONAL CONTROLS AND ADJUSTMENTS

### STARTING AND STOPPING THE TOOL

The power switch (A) Fig. 22, located under the safety cover (B) Fig. 21, provides electrical power to the adjustable speed drive. Lift the safety cover (B) and move the switch up to the "ON" position. To turn the power off, push the safety cover (B) down.

**NOTE:** In case of emergency, immediately push the safety cover (B) down to shut off power.

### LOCKING SWITCH IN THE "OFF" POSITION

**IMPORTANT:** When the tool is not in use, the switch should be locked in the "OFF" position to prevent unauthorized use, using a padlock (C) Fig. 22, with a 3/16" diameter shackle inserted through the holes in the switch plate (D) Fig. 22B.

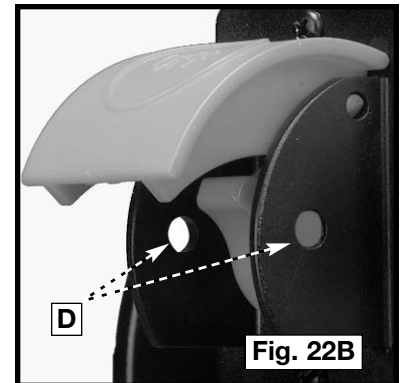
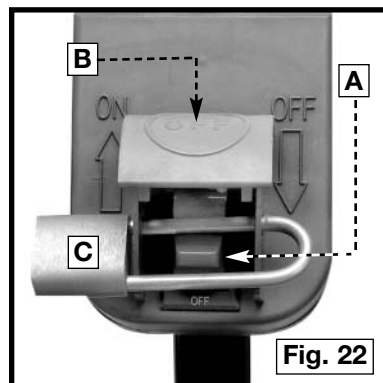
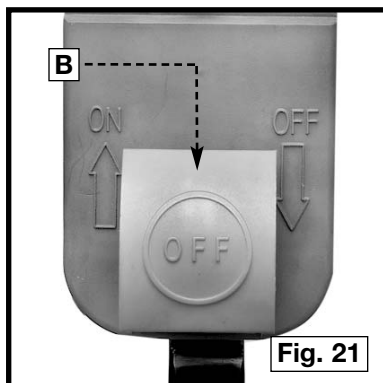

## ACTIVATING THE SPINDLE

**IMPORTANT:** Unlock the spindle lock **BEFORE** operating the tool. The unlocked position is shown in Fig. 23A while the locked position is shown in Fig. 23B.

## CHANGING SPEED RANGES

**IMPORTANT:** Change speeds **ONLY** when the tool is running.

This tool provides variable rate spindle speeds from 600 to 2200 RPM. To change speeds, depress the release (A) Fig. 24 and rotate the lever (B). Turning the lever clockwise increases the speed while turning it counter-clockwise decreases the speed.

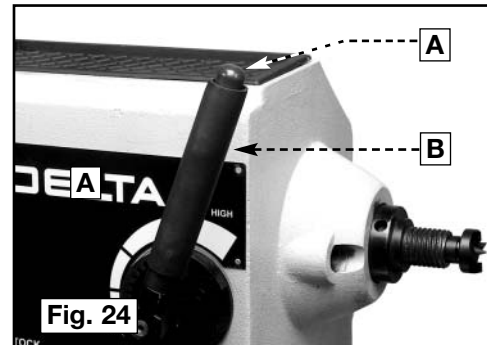

## ALIGNING THE HEADSTOCK CENTER TO THE TAILSTOCK CENTER

The tailstock will move slightly when it is tightened. To ensure that the tailstock center will always be in line with the headstock center:

1. Install the pointed centers (A) and (B) Fig. 25 into the spindles.
2. Loosen the locking lever (back side of the tailstock), and slide the tailstock (D) to the left until the tailstock center (B) is almost contacting the headstock center (A). Tighten the locking lever. Check to see if the tailstock center point (B) is in line with the headstock center point (A).
3. To adjust, loosen the headstock locking shaft (C) Fig. 25, and align the headstock center point to the tailstock center point. Tighten the locking shaft (C) Fig. 25.

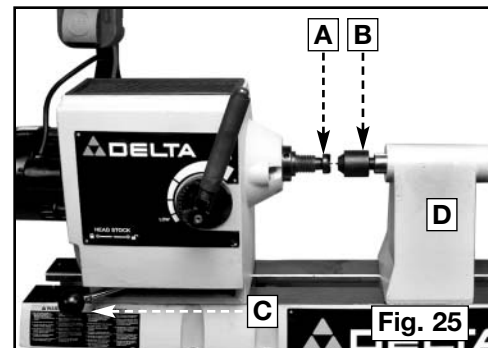

## MACHINE USE

### GLOSSARY

1. **Beads** - Rounded section between grooves.
2. **Gouge Tool** - (A) Fig. 26 - used mostly for roughing cuts and cove cuts.
3. **Grind** - Bevel part of a chisel.
4. **Heel** - The bottom of the angle on a Skew chisel.
5. **Live center** - Supports the workpiece on the tail stock.
6. **Parting Tool** - (C) Fig. 26 - used for cutting-off or making straight incisions or sizing cuts.
7. **Round-Nose Scraper** - (D) Fig. 26 - used for hollowing.
8. **Shoulder** - Edge of a groove in the workpiece.
9. **Skew Chisel** - (B) Fig 26 - used for smoothing cylinders, cutting shoulders, beads, and V-grooves.
10. **SpindleTurning** - Working with any material that is attached to the lathe centers.
11. **Spur** - Attaches to the work;piece and causes the workpiece to turn.
12. **Square-end Scraper** - (E) Fig. 26 - used for the outside of bowls.
13. **Toe** - The top the the angle on a skew chisel.
14. **Vee-cuts** - Cuts in a workpiece shaped like the letter "V".

## LATHE TOOLS

Standard wood turning tools come in several different configurations (Fig. 26). The majority of turnings will require the gouge tool (A) Fig. 26. This round nosed hollow chisel is used for roughing cuts, cove cuts and other operations. The skew chisel (B) is a double-ground flat chisel, with an angled end. This tool is used for smoothing cylinders, for cutting shoulders, beads, vee-grooves, etc. The parting tool (C) is a double-ground chisel, used for cutting-off, or for making straight incisions or sizing cuts to any required diameter. The round nose scraper (D) is used for mostly hollowing work, while the square-end scraper (E) is mainly used for the outside of bowls.

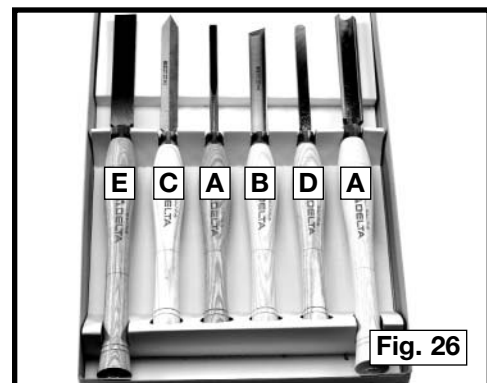

## HOW TO TURN SPINDLES

Spindle turning is the principal type of wood turning (chair and table legs, lamp stems, etc.) The turning of spindles can be done with either a scraping or cutting technique. The cutting technique, by virtue of faster wood removal and a cleaner surface, is the preferred method.

### CENTERING THE WORK

Wood stock for any spindle turning should be approximately square, and the ends should be square with the sides. Two common methods of determining the center are shown in Figs. 27 and 28. In Fig. 27, a distance a little more or a little less than one-half the width of the stock is set off from each of the four sides. The small square set off in the center can then be used in marking the true center. The diagonal method, Fig. 28, consists of drawing lines from corner to corner, with the intersection marking the center of the work.

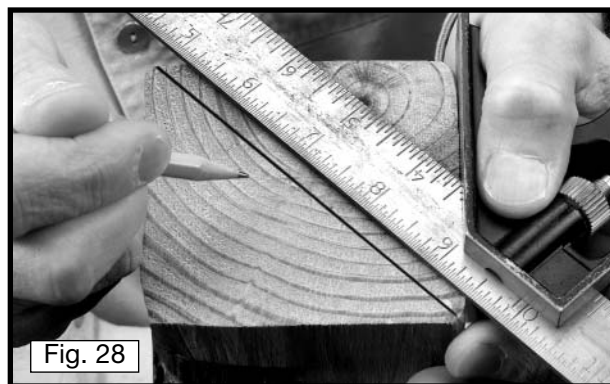
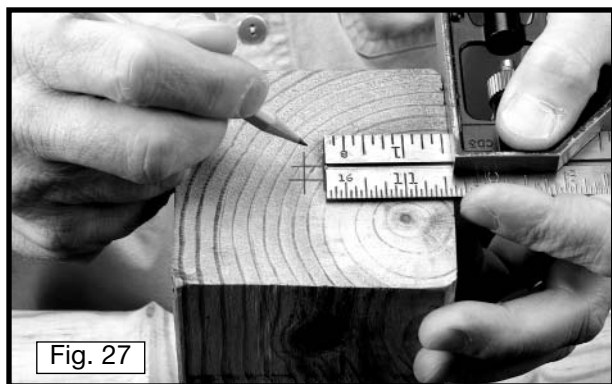

After marking each end, mark the true center with a punch awl (Fig. 29). If the stock is hardwood, the centers should be drilled to a depth of about  $1/8$ ". The spur or live center is then placed against one end of the work and seated by striking with a mallet (Fig. 30). In hardwood, make a starting seat for the spur center by sawing on the diagonal lines, and drilling a small hole at the intersection. After driving the center, hold the center and the work together and fit both immediately to headstock spindle. If you are not using a ball bearing center, the end of work at tailstock center should be oiled. Place the lubricant on the wood either before or after it is put on the lathe. Many turners use beeswax, tallow, or a wax-and-oil mixture as a lubricant. A ball bearing center is ideal because it eliminates lubricating. If the work is to be removed from the lathe before completion, an index mark should be made as a guide for re-centering (Fig. 31). A permanent indexer can be made by grinding off one corner of one of the spurs.

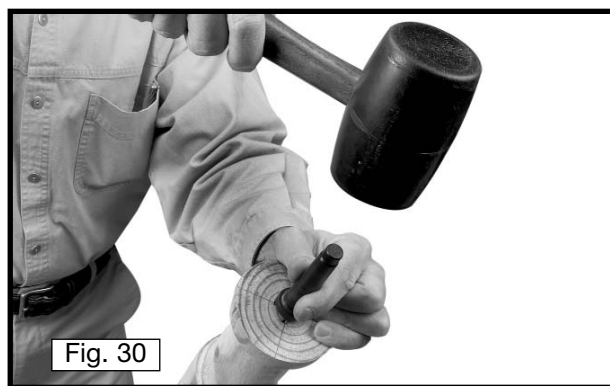
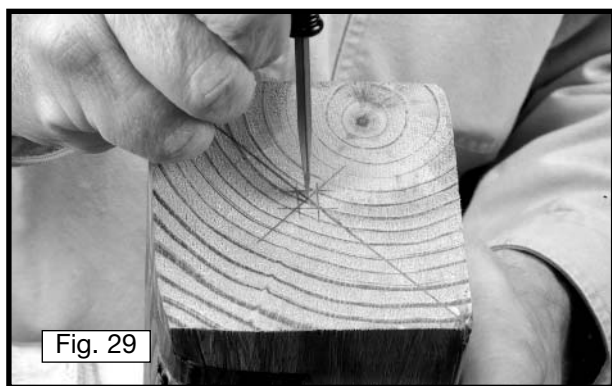

### MOUNTING THE WORK

Mount the work by moving the tailstock to a position about 1" or 1-1/2" from the end of the workpiece, and locking it in this position. Advance the tailstock center by turning the feed handle until the center cup makes contact with the work. Do not support the work on the center pin alone. Always have the rim of the center cup imbedded at least  $1/8$ " into the work. Continue to advance the center while slowly rotating the work by hand. After it becomes difficult to turn the work, slack off on the feed about one-quarter turn and lock the tailstock spindle.

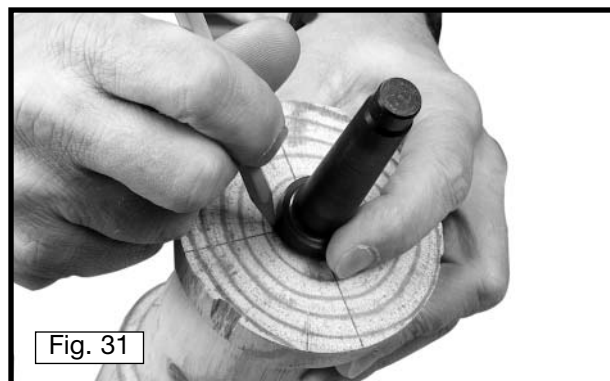

## TOOL REST POSITION

Mount the tool rest in place about 1/8" away from the work and 1/8" above the work centerline (Fig. 32.) This position may vary to suit both you and the work. Place a guide mark on the tool rest shank as an aid to quick and accurate resetting.

**⚠ CAUTION** Clamp the tool rest firmly before operating the lathe.

## ROUGHING A CYLINDER

The large gouge is used in the first turning operation by smoothing the sharp corners of the work. Run the lathe at low speed and hold the gouge in the manner shown in Fig. 33 The cut starts about 2 inches from the tailstock end and continues from this point to the end of the tailstock. Make the second pass beginning about 2" or 3" to the left of the first cut. Advance again toward the tailstock, and merge with the previous cut. Toward the end of the live center, roll the gouge in the opposite direction (Fig. 34) to carry the final cut off the live center end of the work. The roughing cut should not be carried out with one continuous movement, because this would tear long slivers from the corners of the work. Neither should the cut be started directly at the end of the stock for the same reason. You can safely carry the cut from the center of the stock toward and off either end once the first roughing cuts have been made.

The position of the gouge involves two or three important angles. (1) Advance the tool along the work either from right to left or from left to right. Left to right (from headstock to tailstock) is preferred since this action throws chips clear of the operator. (2) Roll the gouge over slightly in the same direction that it is advancing. (3) Hold the tool well up on the work, with the bevel to the revolving surface (Fig. 35). This position will give a clean shearing cut. When pushed straight into the work (Fig. 35), the gouge has a scraping action, (normally a poor practice in spindle turning). Continue the roughing cut until the work approaches 1/8" of the required diameter. Once a cylindrical form has been obtained, you can change the turning speed to the second or third speed setting.

**NOTE:** Continue to move the tool rest inward toward the work piece to keep the safe distance between the two.

## POSITION OF HANDS

While turning, the hand that holds the tool handle should be in a natural position. This hand provides the leverage for the tool by either moving in toward the workpiece or moving out. The position of the tool rest hand is more a matter of individual preference, rather than a "set" or "proper" position. However, a palm-up grip (Fig. 36) is generally considered best. In this position, the first finger acts as a guide, sliding along the tool rest as the cut is made. The alternate position is a palm-down grip (Fig. 37). In this position, the heel of the hand or the little finger serves as a guide. The palm-down position is solid and positive - excellent for roughing or heavy cutting. Most beginners start with the palm-down grip, switching later to the palm-up position for better manipulation of the chisel.

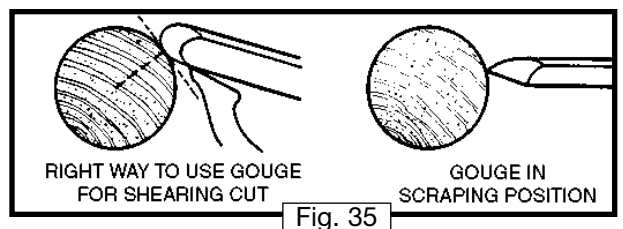
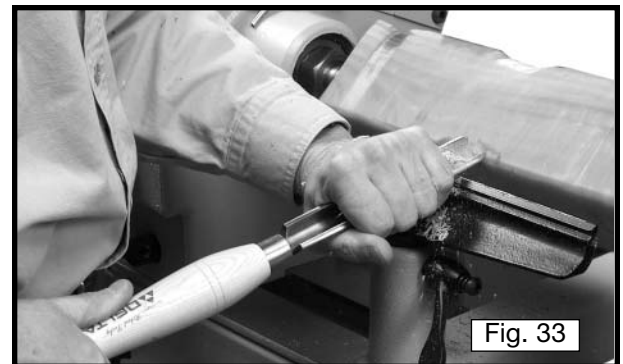
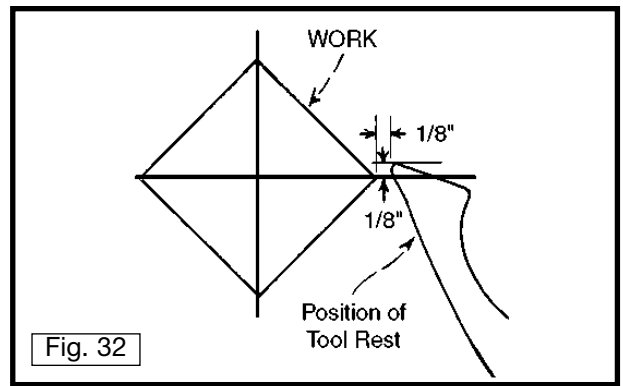

## SMOOTHING A CYLINDER

To smooth a cylinder, use a large skew chisel. This requires practice, but experience with this tool is very important. Place the cutting point near the center of chisel and high on the work (Fig. 38). Sometimes, in striving for a certain position in relation to the work, the beginner will often overlook this all-important point. Raising the handle will increase the depth of cut while lowering the handle, of course, does the opposite. As with the gouge, you can advance the skew in either direction. The center of the skew toward the heel does the actual cutting. The back portion of the grind or bevel supports the tool, while the handle-hand controls the depth of cut by rocking the chisel on this pivot point. Because of this, keep the skew bevel perfectly flat.



## USING THE PARTING TOOL

The parting tool is perhaps the easiest turning chisel to handle. Simply push this scraping tool into the work (Fig. 39). You can achieve a somewhat better cutting action if the handle is held low. This tool is, in many cases, held with one hand while the other hand holds the calipers in the cutting groove. When parting tool cuts are deep, make a clearance cut alongside the first cut (Fig. 40) to prevent burning the tool point.



## SQUARING AN END

You can use the parting tool to quickly square an end. Since the parting tool is a rough cutter, the cut can then be smoothed by the use of the skew. However, you can do the whole operation with the skew. First, make a nicking cut with the toe of the skew (Fig. 41). A deep cut here could burn the chisel, so make a clearance cut by inclining the skew away from the first cut and pushing the tool into the work. This procedure of side cut and clearance cut is continued as often as needed.

**NOTE:** While the skew can be pushed into the wood in any direction, the cutting edge itself must be inclined a little away from this plane. If the full cutting edge of skew bears against the cut surface, the tool will have a tendency to run. See Fig. 42 for the proper way to make the cut. Push the chisel straight into the work, and incline the cutting edge away from the cut surface. Use only the extreme end of the toe for this cut. This important principle in skew handling will be used repeatedly in making shoulders, beads and vee cuts.

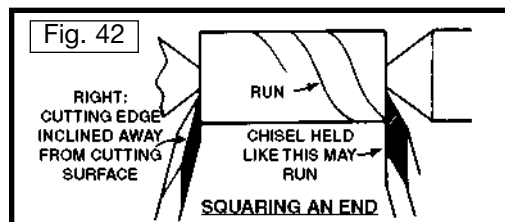

## CUTTING A SHOULDER

Use the parting tool first to reduce the wood to within 1/16" of the required shoulder and diameter (Fig. 43). Clean the waste stock out with the gouge (Fig. 45A), then use the skew for the actual cutting of the shoulder (Figs. 45A and 45B), which is a duplication of squaring an end. The skew then makes the horizontal cut, but in a different manner from plain cylinder work. If the shoulder is long, use the ordinary skew position for the outer portion of the cut. Move the chisel in at the angle shown in Fig. 45B. In this position, raise the handle of the chisel slightly to allow it to cut while the tool moves along the rest. Use a very light cut to produce smooth work. The heel of the skew can be used for making the entire cut, if desired, but the cut, whether in this position or any other position, should not be picked up directly at the end of the stock. Horizontal cuts started directly from the end of the work will have a tendency to bite into the wood, often ruining the entire piece. Always run off the end and not into it. Where a very short shoulder makes this impossible, use the skew in a flat scraping position. If the cutting technique is used, engage only with the heel of skew in a very light cut.



Fig. 43



Fig. 44

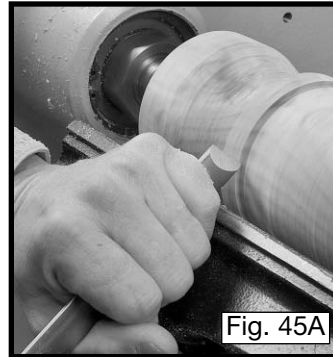

Fig. 45A



Fig. 45B

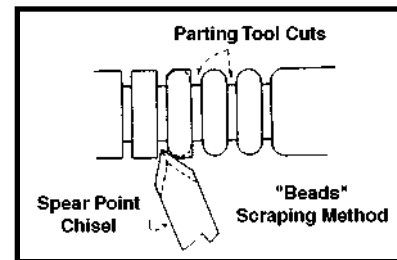

Fig. 46

## CUTTING SMALL BEADS

Beads can be scraped or cut. Using the spear chisel is the easiest method of scraping, and works to best advantage on beads separated by parting tool cuts (Fig. 46). Scraping is slower than cutting and is not as clean, but it has the advantage of protecting the work from long gashes.

Cutting beads quickly and accurately with the small skew is one of the most difficult lathe operations. Various working methods can be used. The first cut is a vertical incision at the point where the two curved surfaces will eventually come together. Make this cut with either heel or toe of skew. Fig. 47 shows the use of the toe. Place the skew at right angles to the work. Place the chisel flat on its side at the start, and rotate it evenly through the successive stages of the cut (Figs. 48, 49, and 50). At the same time, pull the chisel slightly backward to maintain the cutting point. Make the entire cut with the heel of chisel. The opposite side of the bead is cut in the same manner, one cut serving to produce the full shape in each instance. This action produces beads that are beautifully smooth and polished, and the technique is well worth mastering.

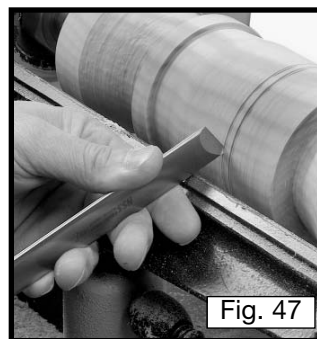

Fig. 47

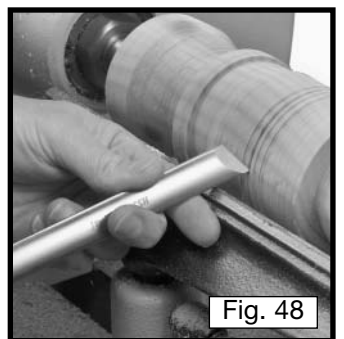

Fig. 48



Fig. 49

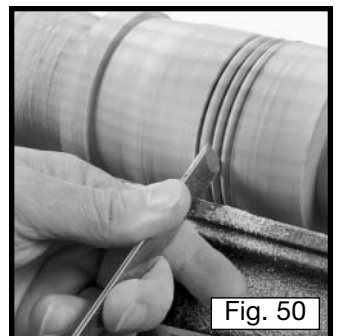

Fig. 50

## VEE GROOVES

Cutting the vee groove demands much the same technique as the bead, except that the skew is hinged straight into the work without rotation (Fig. 51). Only one-half of the vee is made at a time, and one, two, or more cuts may be needed on each side to obtain the desired shape. As in all cutting with the skew, use the bevel next to the cut as a fulcrum. Be careful not to allow the full edge of the chisel to catch and cause a run. Vee grooves can also be made with the toe of the skew, in the same manner as squaring an end.



## LONG CUTS

Long cuts are usually either convex or straight-tapered surfaces. With a convex surface, the method used in making the finishing cut is shown in Fig. 52. Turn the gouge on the tool rest so that it will be inclined in the direction that it will move. The bevel is at approximately a 45 degree angle to the work, and the center point of the cutting edge is the contact point with the wood. As the cut progresses toward and around the end of the curve, the handle is gradually raised and swiveled to the right (Fig. 53) in order to maintain the angle between the grind and workpiece.



Figs. 54 and 55 show the cutting of a long taper with a skew. The operation differs from smoothing a cylinder only at the start of the cut. The starting cut should be made with the heel (Fig. 54) to prevent the tool from digging into the work. As the tool moves down the work, the chisel can be pulled back to allow the center point of the cutting edge to cut. However, the full taper can be made with the heel. Be careful not to cut too deeply at the center of the taper. The direction of cutting is always downhill.



## COVE CUTS

Second to forming a perfect bead, the cove or concave cut is the most difficult to master. This cut is made with the gouge, where the size of the tool depends on the size of the cut. Push the gouge directly into the work to remove the surplus stock (Fig. 56).





Place the gouge on edge on the tool rest so that the grind of the chisel forms an approximate right angle with the work (Fig. 57). The chisel contacts the work at the center of the cutting edge. Hold the tool so that the centerline of the gouge is pointing directly toward the center of the revolving stock. This starting position is important to prevent the gouge from running along the surface of the work.

From the starting position, push the gouge into the revolving stock, and roll the tool on the rest. A triple action takes place here. (1) The chisel will roll to follow the shape of the cut, (2) the handle will drop slightly so that the portion already cut will force the lip of the chisel sideways and, (3) the chisel will be pushed forward so that at the end of the cut, Fig. 58, it will be well up on the work and at an angle with the cut surface. Make only one-half of the cut at a time, then reverse the chisel to cut the other half. The occasional turner should make cove cuts with a scraping technique, using either the small gouge or round nose chisel.

## SQUARE SECTIONS

When the turning has a square section, joint the stock before turning. Good centering is essential since any error will show at the shoulder where the round meets the square. Turning of the shoulder from square to round can be done in various ways. If the parting tool is sharp, you can omit the nicking cut with skew (Fig. 59). The successive cuts are shown in Figs. 60 and 61. You can perform the final trimming operation (Fig. 62) with either the skew, spear chisel, or gouge. This is a scraping operation. While the shoulder can be cut with the same technique used for cutting a bead, the simpler scraping method pictured does clean work and is easier to do.

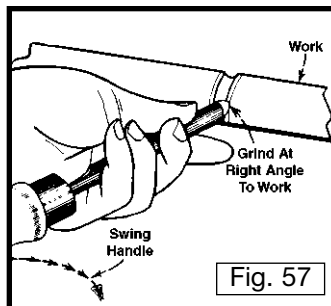

Fig. 57

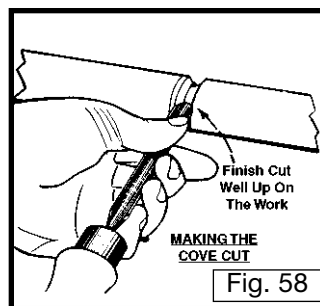

Fig. 58



Fig. 59



Fig. 60



Fig. 61



Fig. 62

## FACEPLATE TURNING

Mount turnings that cannot be worked between centers on a faceplate. The greater part of this type of turning is done with the faceplate mounting, although there are a number of jobs which require special chucks. All cutting in faceplate work is done by scraping. Any attempt to use a cutting technique on the edge grain of large work will result in a hogging, gouging cut which may jerk the chisel out of the hands of the operator. Use a band saw on all work to roughly cut the turning area slightly oversized to eliminate heavy roughing cuts in turning.

## MOUNTING THE WORKPIECE TO THE FACEPLATE

Fig. 63 shows direct mounting to the 3" faceplate along with attaching to the backing block. Because of the ease of setting up, use this mounting whenever the work permits. Hold larger pieces in the same way by using the 6" faceplate. When normal screwfastenings interfere, mount the work on a backing block (Fig. 63). When screws are not permissible at all, glue the work to the backing block by fitting a sheet of paper at the joint to allow later separation without damaging the wood. Some work can be screwed or nailed from the face side into backing block. Mount work less than 3" in diameter on the single screw center (Fig. 64).

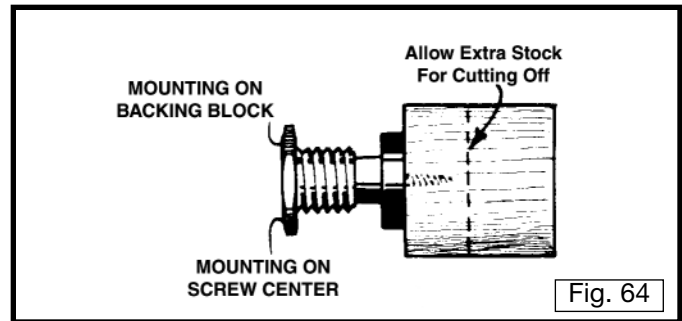
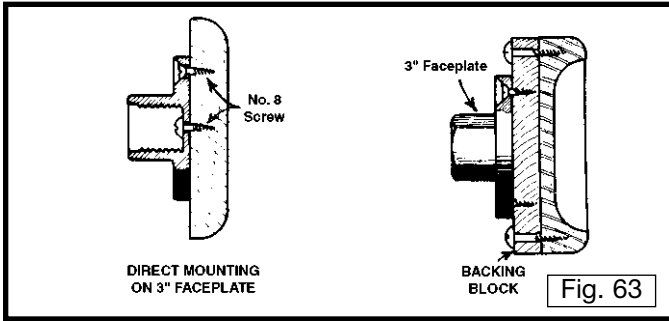

## INBOARD/OUTBOARD TURNING

For workpieces that require additional space for turning, or for the turning of bowls, etc., outboard turning is the answer. To make outboard turnings:

1. Remove the tool rest base and the tailstock from the lathe bed.
2. The headstock can turn to any angle. Move the handle (A) Fig. 65 and turn the headstock to the angle best suited for the work. Lock the headstock in place by moving the handle back to the left.
3. If the faceplate is already on the headstock, remove it by inserting the knockout bar (A) Fig. 66 in the side hole of the spindle (B) Fig. 66 to hold the spindle in place. Use the supplied wrench (C) Fig. 66 to loosen the faceplate. Remove the faceplate (D) by turning it counterclockwise with your hand.

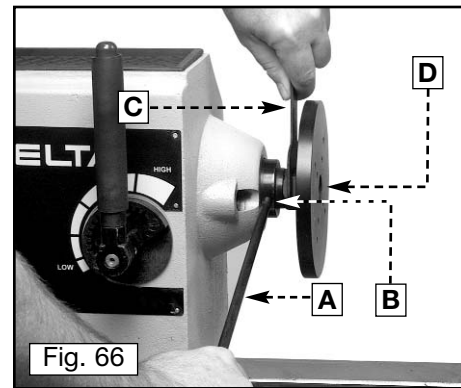
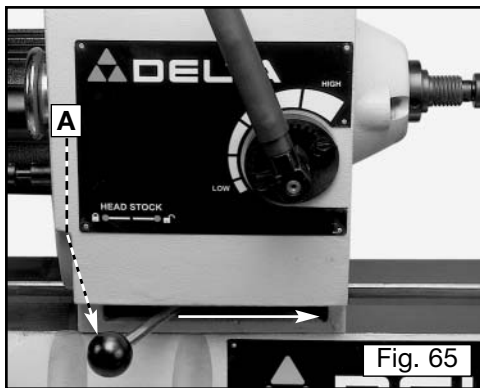

6. The tool rest with the auxiliary extension can be placed in several different angles and positions. Select the one best suited for your work. Fig. 67 shows the position normally used for bowls and other outboard turnings. To move the tool rest on the bed, loosen the handle (A) Fig. 67 and slide the tool rest to the desired position, and then tighten the handle. To change the angle of the tool rest, loosen the handle (B) Fig. 67, move the auxiliary extension to the desired position, then retighten. To raise the height of the tool rest, loosen the handle (C), raise the tool rest to the desired height, then retighten.
7. Fig. 68 illustrates a typical inboard faceplate turning set-up. Inboard faceplate turning is used mostly when the workpiece (A) will rotate freely over the lathe bed. The workpiece (A) is mounted to a faceplate and the faceplate is threaded onto the spindle. Note that the standard equipment tool rest (B) can be adjusted to turn the outside diameter of the workpiece.

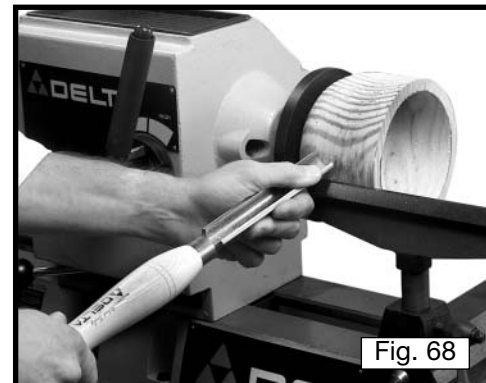
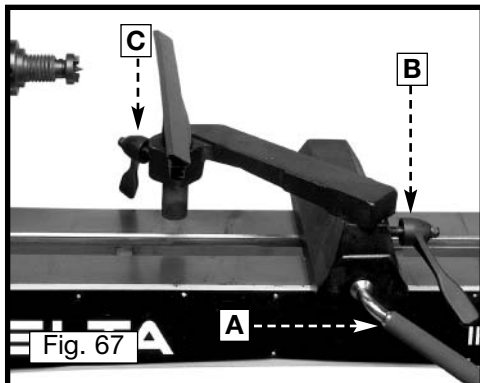

8. Fig. 69 illustrates the rough cutting of the inside of a bowl.
9. Outboard turning is illustrated in Fig. 70. Note that the headstock (A) is turned 45 degrees and the tool rest auxiliary extension (B) is attached. Outboard turning generally is used for larger workpieces, but smaller work can be accomplished using this technique.

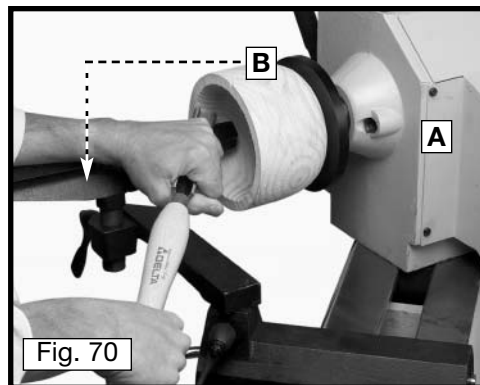
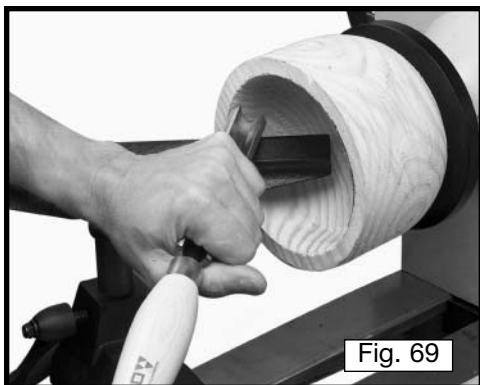

## TROUBLESHOOTING

For assistance with your machine, visit our website at [www.deltamachinery.com](http://www.deltamachinery.com) for a list of service centers or call the DELTA Machinery help line at 1-800-223-7278 (In Canada call 1-800-463-3582).

## MAINTENANCE

### KEEP MACHINE CLEAN

Periodically blow out all air passages with dry compressed air. All plastic parts should be cleaned with a soft damp cloth. NEVER use solvents to clean plastic parts. They could possibly dissolve or otherwise damage the material.

**⚠ WARNING** Wear ANSI Z87.1 safety glasses while using compressed air.

### FAILURE TO START

Should your machine fail to start, check to make sure the prongs on the cord plug are making good contact in the outlet. Also, check for blown fuses or open circuit breakers in the line.

### REPLACING DRIVE BELT

1. Remove the four screws (A) Fig. 71 (three of which are shown) to take the back off of the headstock.

### LUBRICATION

Apply household floor paste wax to the machine table and extension table or other work surface weekly.

### PROTECTING CAST IRON FROM RUST

To clean and protect cast iron tables from rust, you will need the following materials: 1 pushblock from a jointer, 1 sheet of medium Scotch-Brite™ Blending Hand Pad, 1 can of WD-40®, 1 can of degreaser, 1 can of TopCote® Aerosol. Apply the WD-40 and polish the table surface with the Scotch-Brite pad using the pushblock as a holddown. Degrease the table, then apply the TopCote® accordingly.

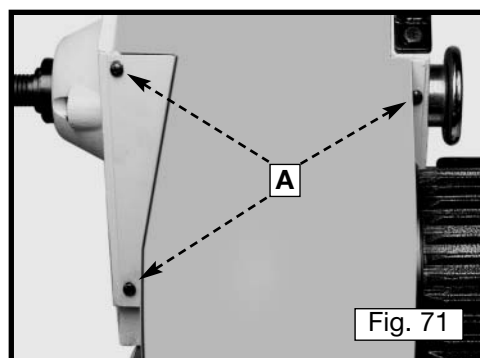

2. Use a #5 Allen wrench to remove the three screws (A) Fig. 72. Slide the spindle handle out. Pull the spindle lock to the out position (see Fig. 24A).

3. Remove the belt (A) Fig. 73 from the pulley (B).

**NOTE:** When pulling the belt out or replacing the belt, pull the spindle lock handle (B) Fig. 72 out to its fullest position to give more room (C) Fig. 73 for belt removal or replacement.

4. Replace new belt by using these instructions in reverse order.

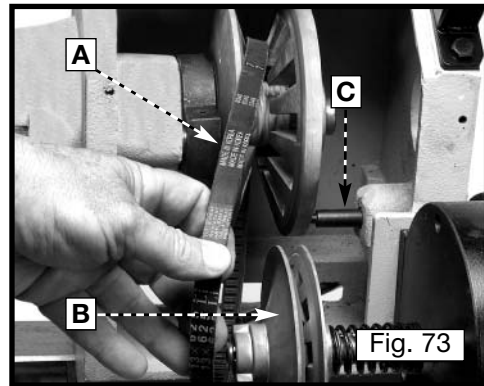
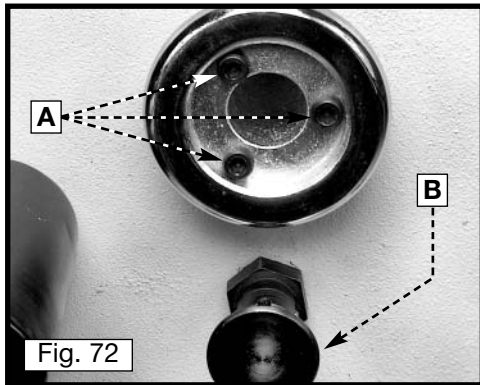

## SERVICE



### PARTS, SERVICE OR WARRANTY ASSISTANCE

All Delta Machines and accessories are manufactured to high quality standards and are serviced by a network of Porter-Cable • Delta Factory Service Centers and Delta Authorized Service Stations. To obtain additional information regarding your Delta quality product or to obtain parts, service, warranty assistance, or the location of the nearest service outlet, please call 1-800-223-7278 (In Canada call 1-800-463-3582).

## ACCESSORIES

A complete line of accessories is available from your Delta Supplier, Porter-Cable • Delta Factory Service Centers, and Delta Authorized Service Stations. Please visit our Web Site [www.deltamachinery.com](http://www.deltamachinery.com) for a catalog or for the name of your nearest supplier.

**⚠WARNING** Since accessories other than those offered by Delta have not been tested with this product, use of such accessories could be hazardous. For safest operation, only Delta recommended accessories should be used with this product.

# WARRANTY



## Two Year Limited New Product Warranty

Delta will repair or replace, at its expense and at its option, any new Delta machine, machine part, or machine accessory which in normal use has proven to be defective in workmanship or material, provided that the customer returns the product prepaid to a Delta factory service center or authorized service station with proof of purchase of the product within two years and provides Delta with reasonable opportunity to verify the alleged defect by inspection. For all refurbished Delta product, the warranty period is 180 days. Delta may require that electric motors be returned prepaid to a motor manufacturer's authorized station for inspection and repair or replacement. Delta will not be responsible for any asserted defect which has resulted from normal wear, misuse, abuse or repair or alteration made or specifically authorized by anyone other than an authorized Delta service facility or representative. Under no circumstances will Delta be liable for incidental or consequential damages resulting from defective products. This warranty is Delta's sole warranty and sets forth the customer's exclusive remedy, with respect to defective products; all other warranties, express or implied, whether of merchantability, fitness for purpose, or otherwise, are expressly disclaimed by Delta.

# NOTES

## PORTER-CABLE • DELTA SERVICE CENTERS (CENTROS DE SERVICIO DE PORTER-CABLE • DELTA)

Parts and Repair Service for Porter-Cable • Delta Machinery are Available at These Locations  
(Obtenga Refaccion de Partes o Servicio para su Herramienta en los Sigüientes Centros de Porter-Cable • Delta)

### ARIZONA

Phoenix 85013-2906  
4501 N. 7th Ave.  
Phone: (602) 279-6414  
Fax: (602) 279-5470

### CALIFORNIA

Ontario 91761 (Los Angeles)  
3949A East Guasti Road  
Phone: (909) 390-5555  
Fax: (909) 390-5554

San Diego 92111  
7290 Clairemont Mesa Blvd.  
Phone: (858) 279-2011  
Fax: (858) 279-0362

San Leandro 94577 (Oakland)  
3039 Teagarden Street  
Phone: (510) 357-9762  
Fax: (510) 357-7939

### COLORADO

Denver 80223  
700 West Mississippi Ave.  
Phone: (303) 922-8325  
Fax: (303) 922-0245

### FLORIDA

Davie 33314 (Miami)  
4343 South State Rd. 7 (441)  
Unit #107  
Phone: (954) 321-6635  
Fax: (954) 321-6638

Tampa 33634  
4909 West Waters Ave.  
Phone: (813) 884-0434  
Fax: (813) 888-5997

### GEORGIA

Forest Park 30297 (Atlanta)  
5442 Frontage Road,  
Suite 112  
Phone: (404) 608-0006  
Fax: (404) 608-1123

### ILLINOIS

Addison 60101 (Chicago)  
400 South Rohlwing Rd.  
Phone: (630) 424-8805  
Fax: (630) 424-8895

Woodridge 60517 (Chicago)  
2033 West 75th Street  
Phone: (630) 910-9200  
Fax: (630) 910-0360

### KANSAS

Overland Park 66214  
9201 Quivira Road  
Phone: (913) 495-4330  
Fax: (913) 495-4378

### MARYLAND

Elkridge 21075 (Baltimore)  
7397-102 Washington Blvd.  
Phone: (410) 799-9394  
Fax: (410) 799-9398

### MASSACHUSETTS

Franklin 02038 (Boston)  
Franklin Industrial Park  
101E Constitution Blvd.  
Phone: (508) 520-8802  
Fax: (508) 528-8089

### MICHIGAN

Madison Heights 48071 (Detroit)  
30475 Stephenson Highway  
Phone: (248) 597-5000  
Fax: (248) 597-5004

### MINNESOTA

Eden Prairie 55344  
9709 Valley View Road  
Phone: (952) 884-9191  
Fax: (952) 884-3750

### MISSOURI

St. Louis 63146  
11477 Page Service Drive  
Phone: (314) 997-9100  
Fax: (314) 997-9183

### NEW YORK

Flushing 11365-1595 (N.Y.C.)  
175-25 Horace Harding Expwy.  
Phone: (718) 225-2040  
Fax: (718) 423-9619

### NORTH CAROLINA

Charlotte 28270  
9129 Monroe Road, Suite 115  
Phone: (704) 841-1176  
Fax: (704) 708-4625

### OHIO

Columbus 43229  
1948 Schrock Road  
Phone: (614) 895-3112  
Fax: (614) 895-3187

Cleveland 44125  
8001 Sweet Valley Drive Unit #19  
Phone: (216) 447-9030  
Fax: (216) 447-3097

### OREGON

Portland 97230  
14811 North East Airport Way  
Phone: (503) 255-6556  
Fax: (503) 255-6543

### PENNSYLVANIA

Willow Grove 19090  
(Philadelphia)  
520 North York Road  
Phone: (215) 658-1430  
Fax: (215) 658-1433

### TEXAS

Carrollton 75006 (Dallas)  
1300 Interstate 35 N, Suite 112  
Phone: (972) 446-2996  
Fax: (972) 446-8157

Houston 77022-2122

536 East Tidwell Rd.  
Phone: (713) 692-7111  
Fax: (713) 692-1107

### WASHINGTON

Auburn 98001(Seattle)  
3320 West Valley HWY, North  
Building D, Suite 111  
Phone: (253) 333-8353  
Fax: (253) 333-9613

Authorized Service Stations are located in many large cities. Telephone **800-438-2486** or **731-541-6042** for assistance locating one. Parts and accessories for Porter-Cable•Delta products should be obtained by contacting any Porter-Cable•Delta Distributor, Authorized Service Center, or Porter-Cable•Delta Factory Service Center. If you do not have access to any of these, call **800-223-7278** and you will be directed to the nearest Porter-Cable•Delta Factory Service Center. Las Estaciones de Servicio Autorizadas están ubicadas en muchas grandes ciudades. Llame al **800-438-2486** ó al **731-541-6042** para obtener asistencia a fin de localizar una. Las piezas y los accesorios para los productos Porter-Cable•Delta deben obtenerse poniéndose en contacto con cualquier distribuidor Porter-Cable•Delta, Centro de Servicio Autorizado o Centro de Servicio de Fábrica Porter-Cable•Delta. Si no tiene acceso a ninguna de estas opciones, llame al **800-223-7278** y le dirigirán al Centro de Servicio de Fábrica Porter-Cable•Delta más cercano.

## CANADIAN PORTER-CABLE • DELTA SERVICE CENTERS

### ALBERTA

Bay 6, 2520-23rd St. N.E.  
Calgary, Alberta  
T2E 8L2  
Phone: (403) 735-6166  
Fax: (403) 735-6144

### BRITISH COLUMBIA

8520 Baxter Place  
Burnaby, B.C.  
V5A 4T8  
Phone: (604) 420-0102  
Fax: (604) 420-3522

### MANITOBA

1699 Dublin Avenue  
Winnipeg, Manitoba  
R3H 0H2  
Phone: (204) 633-9259  
Fax: (204) 632-1976

### ONTARIO

505 Southgate Drive  
Guelph, Ontario  
N1H 6M7  
Phone: (519) 767-4132  
Fax: (519) 767-4131

### QUÉBEC

1515 ave.  
St-Jean Baptiste, Suite 160  
Québec, Québec  
G2E 5E2  
Phone: (418) 877-7112  
Fax: (418) 877-7123

1447, Begin  
St-Laurent, (Montréal),  
Québec  
H4R 1V8  
Phone: (514) 336-8772  
Fax: (514) 336-3505

The following are trademarks of PORTER-CABLE • DELTA (Las siguientes son marcas registradas de PORTER-CABLE • DELTA S.A.) (Les marques suivantes sont des marques de fabricant de la PORTER-CABLE • DELTA): Auto-Set®, BAMMER®, B.O.S.S.®, Builder's Saw®, Contractor's Saw®, Contractor's Saw II™, Delta®, DELTACRAFT®, DELTAGRAM™, Delta Series 2000™, DURATRONIC™, Emc2™, FLEX®, Flying Chips™, FRAME SAW®, Grip Vac™, Homecraft®, INNOVATION THAT WORKS®, Jet-Lock®, JETSTREAM®, 'kickstand®, LASERLOC®, MICRO-SET®, Micro-Set®, MIDI LATHE®, MORTEN™, NETWORK™, OMNIJIG®, POCKET CUTTER®, PORTA-BAND®, PORTA-PLANE®, PORTER-CABLE®&(design), PORTER-CABLE®PROFESSIONAL POWER TOOLS, PORTER-CABLE REDEFINING PERFORMANCE™, Posi-Matic®, Q-3®&(design), QUICKSAND®&(design), QUICKSET™, QUICKSET II®, QUICKSET PLUS™, RIPTIDE™&(design), SAFE GUARD II®, SAFE-LOC®, Sanding Center®, SANDTRAP®&(design), SAW BOSS®, Sawbuck™, Sidekick®, SPEED-BLOC®, SPEEDMATIC®, SPEEDTRONIC®, STAIR EASE®, The American Woodshop®&(design), The Lumber Company®&(design), THE PROFESSIONAL EDGE®, THE PROFESSIONAL SELECT®, THIN-LINE™, TIGER®, TIGER CUB®, TIGER SAW®, TORQBUSTER®, TORQ-BUSTER®, TRU-MATCH™, TWIN-LITE®, UNIGUARD®, Unifence®, UNIFEEDER™, Unihead®, Uniplane™, Unirip®, Unisaw®, Univise®, Versa-Feeder®, VERSA-PLANE®, WHISPER SERIES®, WOODWORKER'S CHOICE™.

Trademarks noted with ™ and ® are registered in the United States Patent and Trademark Office and may also be registered in other countries. Las Marcas Registradas con el signo de ™ y ® son registradas por la Oficina de Registros y Patentes de los Estados Unidos y también pueden estar registradas en otros países.