

Series 2000 Step Pulley Drilling Machines

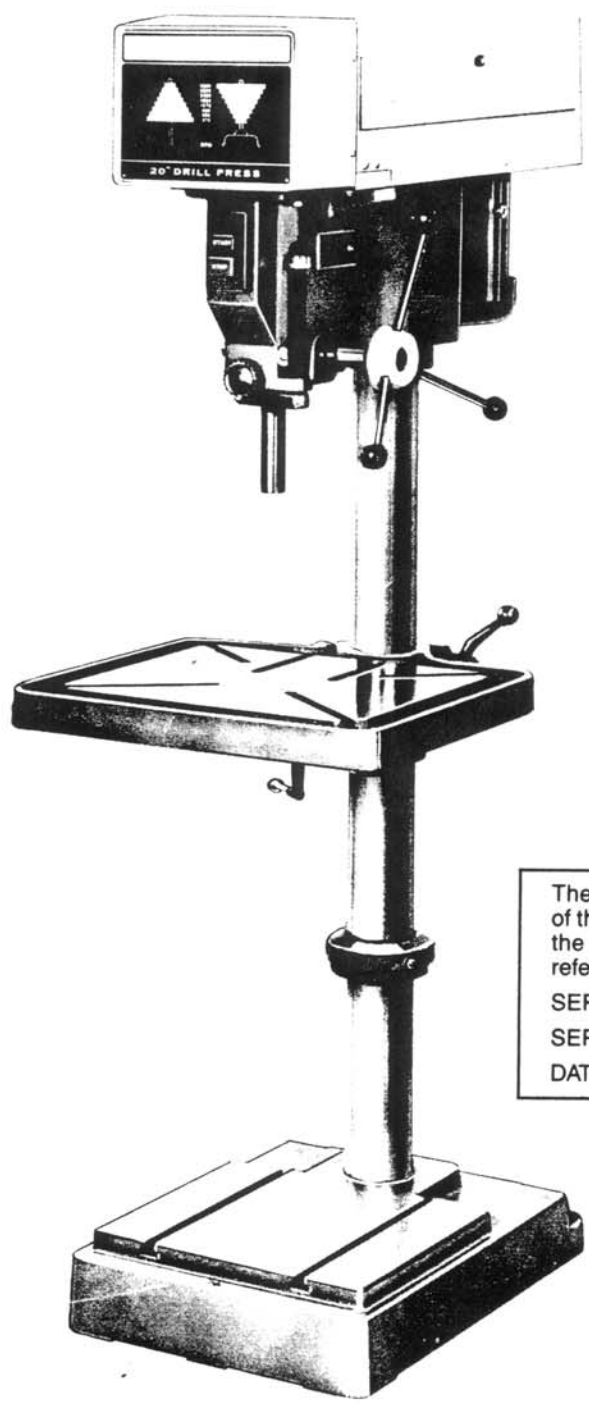

Direct Drive Model - 8 speeds
(375, 600, 900, 1275, 1800,
2400, 3075, 4250 RPM)

The Serial No./Series No. plate is attached to the left side of the machine head casting. Locate this plate and record the Serial No. and Series No. in your manual for future reference.

SERIAL NO. _____
SERIES NO. _____
DATE OF PURCHASE _____

Dated 10-1-86

Part No. 402-06-651-0004
©Delta International Machinery 1986



WARNING: FAILURE TO FOLLOW THESE RULES MAY RESULT IN SERIOUS PERSONAL INJURY

As with all machinery there are certain hazards involved with operation and use of the machine. Using the machine with respect and caution will considerably lessen the possibility of personal injury. However, if normal safety precautions are overlooked or ignored, personal injury to the operator may result.

This machine was designed for certain applications only. Delta Machinery strongly recommends that this machine NOT be modified and/or used for any application other than for which it was designed. If you have any questions relative to its application DO NOT use the machine until you have written Delta Machinery and we have advised you.

DELTA INTERNATIONAL MACHINERY CORP.
MANAGER OF TECHNICAL SERVICES
246 ALPHA DRIVE
PITTSBURGH, PENNSYLVANIA 15238

SAFETY RULES FOR ALL TOOLS

- 1. FOR YOUR OWN SAFETY, READ INSTRUCTION MANUAL BEFORE OPERATING THE TOOL.** Learn the tool's application and limitations as well as the specific hazards peculiar to it.
- 2. KEEP GUARDS IN PLACE** and in working order.
- 3. GROUND ALL TOOLS.** If tool is equipped with three-prong plug, it should be plugged into a three-hole electrical receptacle. If an adapter is used to accommodate a two-prong receptacle, the adapter lug must be attached to a known ground. Never remove the third prong.
- 4. REMOVE ADJUSTING KEYS AND WRENCHES.** Form habit of checking to see that keys and adjusting wrenches are removed from tool before turning it "on."
- 5. KEEP WORK AREA CLEAN.** Cluttered areas and benches invite accidents.
- 6. DON'T USE IN DANGEROUS ENVIRONMENT.** Don't use power tools in damp or wet locations, or expose them to rain. Keep work area well-lighted.
- 7. KEEP CHILDREN AND VISITORS AWAY.** All children and visitors should be kept a safe distance from work area.
- 8. MAKE WORKSHOP CHILDPROOF** - with padlocks, master switches, or by removing starter keys.
- 9. DON'T FORCE TOOL.** It will do the job better and be safer at the rate for which it was designed.
- 10. USE RIGHT TOOL.** Don't force tool or attachment to do a job for which it was not designed.
- 11. WEAR PROPER APPAREL.** No loose clothing, gloves, neckties, rings, bracelets, or other jewelry to get caught in moving parts. Nonslip foot wear is recommended. Wear protective hair covering to contain long hair.
- 12. ALWAYS WEAR EYE PROTECTION.** Refer to ANSI Z87.1 Standard for appropriate recommendations. Also use face or dust mask if cutting operation is dusty.
- 13. SECURE WORK.** Use clamps or a vise to hold work when practical. It's safer than using your hand and frees both hands to operate tool.
- 14. DON'T OVERREACH.** Keep proper footing and balance at all times.
- 15. MAINTAIN TOOLS IN TOP CONDITION.** Keep tools sharp and clean for best and safest performance. Follow instructions for lubricating and changing accessories.
- 16. DISCONNECT TOOLS** before servicing and when changing accessories such as blades, bits, cutters, etc.
- 17. USE RECOMMENDED ACCESSORIES.** Consult the owner's manual for recommended accessories. The use of improper accessories may cause hazards.
- 18. AVOID ACCIDENTAL STARTING.** Make sure switch is in "OFF" position before plugging in power cord.
- 19. NEVER STAND ON TOOL.** Serious injury could occur if the tool is tipped or if the cutting tool is accidentally contacted.
- 20. CHECK DAMAGED PARTS.** Before further use of the tool, a guard or other part that is damaged should be carefully checked to ensure that it will operate properly and perform its intended function - check for alignment of moving parts, binding of moving parts, breakage of parts, mounting, and any other conditions that may affect its operation. A guard or other part that is damaged should be properly repaired or replaced.
- 21. DIRECTION OF FEED.** Feed work into a blade or cutter against the direction of rotation of the blade or cutter only.
- 22. NEVER LEAVE TOOL RUNNING UNATTENDED. TURN POWER OFF.** Don't leave tool until it comes to a complete stop.
- 23. DRUGS, ALCOHOL, MEDICATION.** Do not operate tool while under the influence of drug, alcohol or any medication.
- 24. MAKE SURE TOOL IS DISCONNECTED FROM POWER SUPPLY** while motor is being mounted, connected or reconnected.

ADDITIONAL SAFETY RULES FOR DRILL PRESSES

- 1. BE SURE** drill bit or cutting tool is securely locked in the chuck.
- 2. BE SURE** chuck key is removed from the chuck before turning on power.
- 3. ADJUST** the table or depth stop to avoid drilling into the table.
- 4. SHUT OFF** the power, remove the drill bit or cutting tool, and clean the table before leaving the machine.
- 5. CAUTION:** When practical, use clamps or a vise to secure workpiece to keep the workpiece from rotating with the drill bit or cutting tool.
- 6. WARNING:** For Your Own Safety — Don't wear gloves when operating a drill press.

SETTING UP

The head and table of your drill press have been lowered on the column for convenience in packaging. To raise the head, proceed as follows:

1. Place a block of wood, about 7" long, between the drill press head and the table, as close to the column as possible.
 2. Make sure the collar at the bottom of the raising mechanism rack is tight on the column and unlock the table clamp. Then loosen the nut located on the right hand side of the head, that locks the head to the column.
 3. Turn the raising mechanism hand crank clockwise to raise the table and head simultaneously.
 4. When the table approaches the top of the raising mechanism rack, lock the table and head to the column. Then loosen the raising mechanism collar and turn the raising mechanism hand crank counterclockwise. This will slide the rack of the raising mechanism further up the column.
 5. Repeat STEPS 2, 3 and 4 until the top of the head is at the desired height. Be sure not to raise the top of the head casting beyond the top end of the column.
 6. With the head and table still loose, visually line up the spindle with the center of the base and lock the head to the column. Make sure the safety collar is locked in place underneath the head.
 7. Position the table and raising mechanism to the desired position on the column and lock them in place.
-

MULTIPLE SPINDLE MODELS

In the case of multiple spindle models, the legs are not attached to the table, they are packed separately. To assemble the legs to multiple spindle models, carefully support machine on wooden horses or other temporary supports and bolt legs securely into position. The tables of multiple spindle models should be carefully leveled. Use a precision level on the table and place wedges under legs of the machine where required. Riser blocks, Cat. No. 50-400, one or two sets per leg, may be used if it is desired to have the table two or four inches higher.

RAISING MECHANISM

All models are furnished with a rack and pinion type raising mechanism. The single spindle floor models use the unit in conjunction with the table, and all other models have it attached to the head.

If on single spindle floor models, a raising mechanism is desired in the head also, it will be necessary to purchase the 20-761 Accessory Head Raising Mechanism.

CLEANING THE MACHINE

The table and all other machined or unpainted surfaces of the drill press are protected with a coating of rust preventive. This coating may be removed with a soft cloth moistened with kerosene (do not use acetone, gasoline or lacquer thinner for this purpose.) After cleaning, cover all unpainted surfaces with a light film of good machine oil.

ELECTRICAL CONNECTIONS

If the motor on your machine is wired for 230V single phase, the power cord is equipped with a plug that has two flat, current-carrying prongs in tandem, and one round or "U"-shaped longer ground prong. This is used only with the proper mating 3-conductor grounding type receptacle, as shown in Fig. 3. When the three-prong plug on your machine is plugged into a grounded, 3-conductor receptacle, the long ground prong on the plug contacts first so the machine is properly grounded before electricity reaches it.

If the motor on your machine is wired for 200V, 230V or 460V three phase, the necessary wiring from the starter to the power source should be completed by a competent electrician.

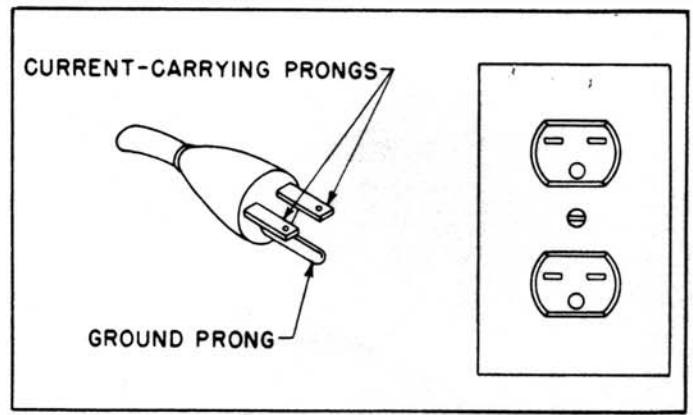

Fig. 3

IMPORTANT: Make sure the electrical characteristics are the same between the motor nameplate and the power source and make sure the power circuit the drill press will be used on is properly fused and that the wire size is correct, as shown in Fig. 4. **MAKE SURE THE DRILL PRESS IS PROPERLY GROUNDED.**

WIRE AND FUSE SIZE

HP	SINGLE PHASE		THREE PHASE			
	230 VOLTS		200 - 230 VOLTS		460 VOLTS	
	WIRE SIZE	TIME LAG FUSE*	WIRE SIZE	TIME LAG FUSE*	WIRE SIZE	TIME LAG FUSE*
1½	12	20	14	15	14	15

Fig. 4 *Size fuse selected for branch circuit protection.

SPINDLE SPEEDS

With the Step Pulley – Direct Drive Drilling Machine you get eight selected speeds with full H P at the spindle at all speeds. The speeds available with your drilling machine are 375, 600, 900, 1275, 1800, 2400, 3075 and 4250 RPM. The highest speed is obtained when the belt is on the largest step of the motor pulley and the smallest step of the spindle pulley.

CHANGING SPEEDS

When changing speeds on your drilling machine, proceed as follows:

1. DISCONNECT MACHINE FROM POWER SOURCE.
2. Loosen wing nut located on the opposite end of the plate (A) Fig. 5. (This wing nut is shown at (D) Fig. 6.) The motor and motor plate can then be tilted forward, as shown in Fig. 5, releasing the belt tension.
3. Open the door (B) Fig. 5, tilt the motor pulley (C) forward, and move the belt to the desired steps on the motor and spindle pulleys, as shown in Fig. 5.
4. After the belt is positioned on the pulleys, close the door (B) Fig. 5, and tighten the wing nut located on the opposite end of the plate (A) to keep the motor pulley, motor and motor plate in the vertical position.

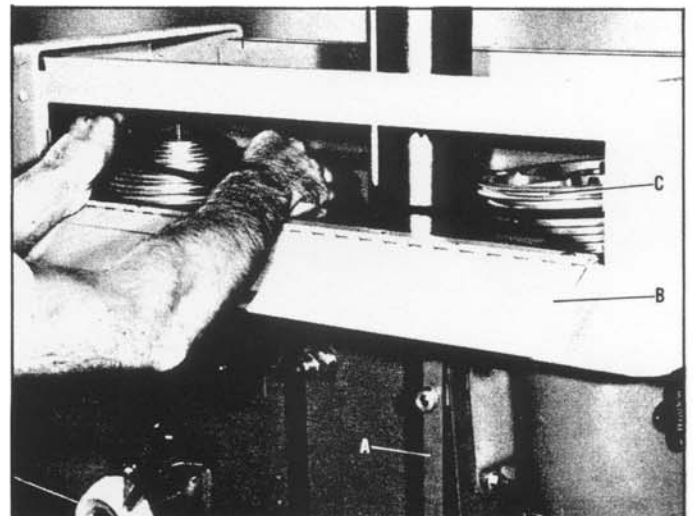

Fig. 5

ADJUSTING BELT TENSION

The correct belt tension is determined by the center to center distance of the motor pulley (A) and the spindle pulley (B) Fig. 6. If it ever becomes necessary to adjust belt tension, proceed as follows:

1. Disconnect the machine from the power source.
2. Loosen the three screws (C) Fig. 6, and while making sure the motor pulley (A) is in parallel alignment with the spindle pulley (B), move the motor and motor plate (E) in or out until the center to center distance between the motor and spindle pulley is 20", as shown in Fig. 6. NOTE: For clarity Fig. 6 is shown with the belt guard removed.

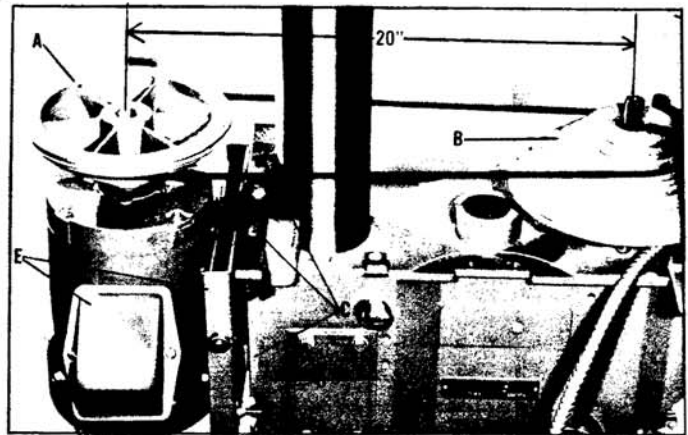

Fig. 6

ADJUSTING SPINDLE RETURN SPRING

For the purpose of automatically returning spindle upward after a hole has been drilled, a spring is provided enclosed in a case and is located on the left side of the drill press head. This spring has been adjusted at the factory and should not be disturbed unless absolutely necessary. If it should become necessary to adjust it, proceed as follows:

1. Remove the depth stop nut (G) and locking sleeve (A) Fig. 7, and make sure the quill locking handle (B) is loose.
2. Rotate the pilot wheel and lower the quill (C) Fig. 7, until the rack on the back of the quill disengages with the pinion shaft (D). A special design is incorporated into the quill to prevent it from dropping out of the head casting.
3. When the quill (C) Fig. 7, is lowered as far as possible, turn the pilot wheel counterclockwise to increase or clockwise to decrease the return spring tension.
4. When the desired tension is obtained push up the quill (C) until it engages with the pinion shaft (D) Fig. 7. The spring tension will then return the quill to the up position.
5. Replace the depth stop nut (G) and locking sleeve (A) Fig. 7.

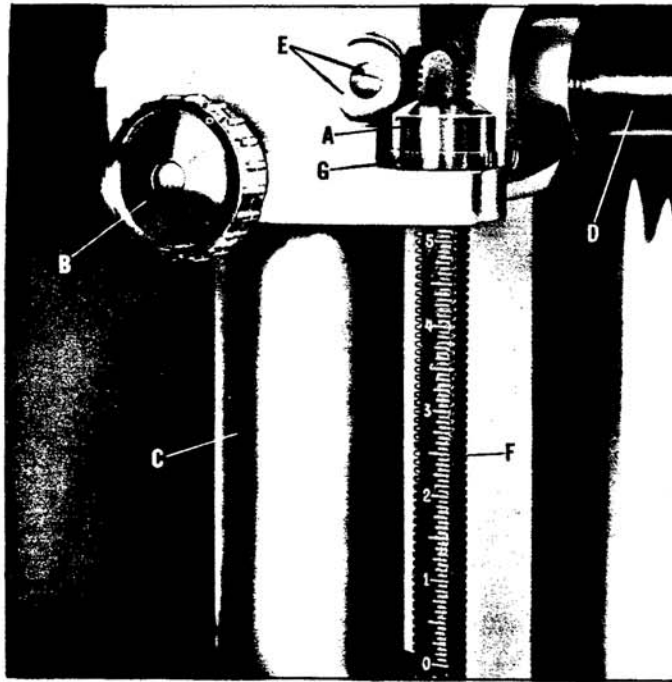

Fig. 7

QUILL ADJUSTMENTS

The quill can be locked at any desired point in its travel, by tightening the quill locking handle (B) Fig. 7. This is an especially desirable feature for set-up of tooling for production type operations.

After considerable use, play may develop between the quill and the head casting due to wear. To compensate for wear between the quill and head, proceed as follows:

1. Make sure the quill locking handle (B) Fig. 7, is loose.
2. Remove two screws and washers (E) Fig. 7. Only one of the screws and washers (E) can be seen in Fig. 7. The other screw and washer is located on the left front side of the head casting.
3. Tighten the two quill adjusting screws which are located directly underneath the two screws and washers (E) Fig. 7. It is not necessary to tighten these screws too much.
4. Rotate pilot wheel to test movement of quill and play. If there is a slight "drag", quill adjusting screws have been adjusted too tight. Back off quill adjusting screws slightly. If the quill still has play, slightly tighten quill adjusting screws.
5. After proper adjustment has been made, replace screws and washers (E) Fig. 7.

DRILLING HOLES TO DEPTH

When drilling one or two holes to a predetermined depth, the calibrations on the face of the depth stop rod (F) Fig. 7, can be used.

When drilling a number of holes to a predetermined depth, or if a more exact setting is required, proceed as follows:

1. Raise the locking sleeve (A) Fig. 7, and turn the micro-nut (G) to the desired position on the stop rod (F).
2. Lower the locking sleeve (A) so it will engage micro-nut (G) Fig. 7. Lock sleeve (A) in place with thumb screw if drill press is mounted in other than vertical position. When the drill press is mounted with the chuck pointing "up", the locking sleeve (A) and micro-nut (G) Fig. 7, should be reversed on the stop rod (F).
3. When locking sleeve (A) is in place on the micro-nut (G) Fig. 7, the micro-nut cannot be turned. When a change in depth is required, the locking sleeve (A) must be raised, and while it is raised, turn the micro-nut (G) the necessary calibration marks. Each mark represents .002". Then lower the locking sleeve (A).
4. The use of the micro-set stop nut will maintain the same hole depth, no matter how many holes are to be drilled. However, we recommend that the hole depth be checked whenever a drill has to be sharpened or changed.

CHANGING SPINDLES

To change the spindle for any reason, proceed as follows:

1. Remove the two nuts and washer (A) Fig. 8 .
2. Carefully pull out the return spring and housing (B) Fig. 8 , about 1/4" until roll pin (C) disengages with the groove in the return spring housing and carefully rotate the return spring housing to release tension on the return spring or refer to the instructions on page 5 under ADJUSTING SPINDLE RETURN SPRING to release spring tension.
3. Disengage the return spring from the screw (D) Fig. 8 , in the pinion shaft, and remove the return spring and housing from the pinion shaft.
4. Loosen screw (E) Fig. 8 , and move retainer (F) up out of the groove (G) in the pinion shaft.
5. Remove screw (D) Fig. 8 , from pinion shaft and while holding the quill with your left hand, remove the pinion shaft (H) by pulling it straight out. The quill assembly can then be easily removed from the head casting.

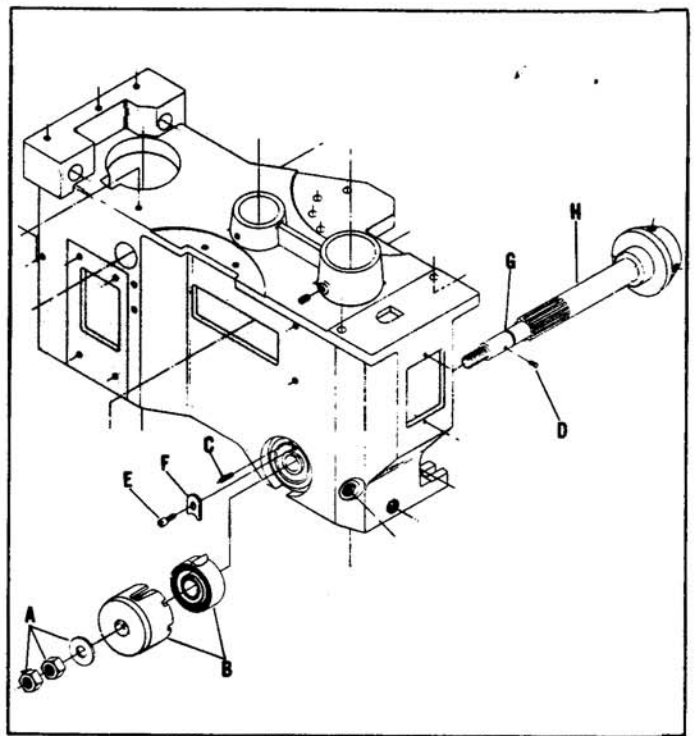

Fig. 8

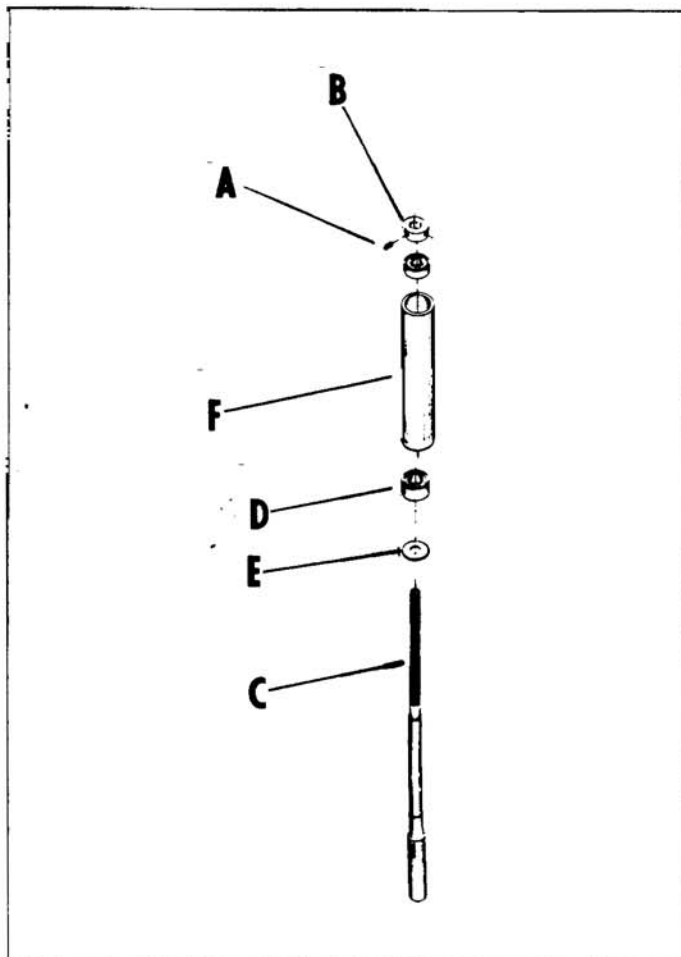

Fig. 9

6. Loosen the two set screws (A) in collar (B) Fig. 9 , and remove collar.
7. With a hard rubber mallet, tap spline end of spindle (C). The spindle (C) with bearing (D) and flinger collar (E) will come out of the quill (F) Fig. 9 .
8. Using an arbor press, remove bearing (D) and flinger collar (E) from spindle (C) Fig. 9 .
9. To replace spindle, reverse above procedure making sure the bearing (D) and flinger collar (E) have been pressed tight against the shoulder on the spindle (C) Fig. 9 , before replacing spindle in quill.
10. After replacing collar with set screws (A & B) Fig. 9 , on the spindle, be sure there is not end play between spindle and quill. Play is eliminated by seating both bearings in quill.
11. When replacing quill in head casting, rotate spindle if necessary to engage spline in pulley.
12. After the quill is replaced, adjust the spindle return spring.



PARTS, SERVICE OR WARRANTY ASSISTANCE

All Delta Machines and accessories are manufactured to high quality standards and are serviced by a network of factory service centers and authorized service stations listed in your owner's manual. To obtain additional infor-

mation regarding your Delta quality product or to obtain parts, service or warranty assistance, please call Delta's toll-free 'hotline' telephone number.

Delta maintains a modern, efficient Parts Distribution Center, maintaining an inventory of over 10,000 parts located in Memphis, Tennessee.

Highly qualified and experienced Customer Service Representatives are standing by to assist you on weekdays from 8:00 A.M. to 5:00 P.M. Memphis time.

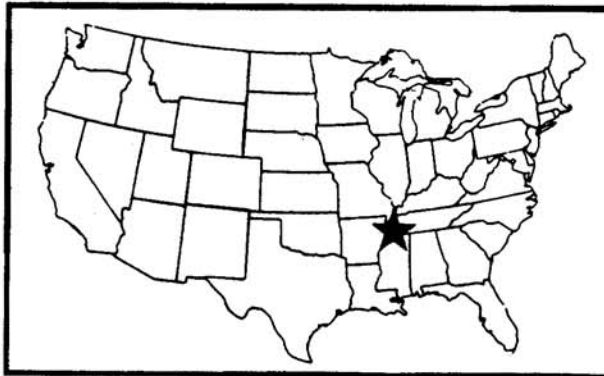

Memphis, TN 38118
4290 Raines Road
Phone: (901) 363-8800

HOTLINE
800-223-PART
(In Tennessee 800-238-PART)

FACTORY SERVICE CENTERS

ALABAMA

Birmingham 35209
Porter-Cable Corporation
131 W. Oxmoor Road, Suite 105
205-942-6345

CALIFORNIA

Los Angeles 90007
Porter-Cable Corporation
2400 S. Grand Avenue
213-749-0386

Orange 92668
Porter-Cable Corporation
365 North Anaheim Blvd.
714-634-4111

San Leandro 94577
Porter-Cable Corporation
3039 Teagarden Street
P.O. Box 1913
415-357-9762

COLORADO

Denver 80207
Porter-Cable Corporation
4900 E. 39th Avenue
303-388-5803

CONNECTICUT

Manchester 06040
Porter-Cable Corporation
57 Tolland Turnpike
203-646-1078

FLORIDA

Hialeah 33014
Porter-Cable Corporation
16373 NW 57th Avenue
305-624-2523

Orlando 32803
Porter-Cable Corporation
1807 1/2 Winter Park Road
305-644-8100

Tampa 33609
Porter-Cable Corporation
4536 W. Kennedy Blvd.
813-877-9585

GEORGIA

Forest Park 30050
Porter-Cable Corporation
4017 Jonesboro Road
404-363-8000

ILLINOIS

Addison (Chicago) 60101
Porter-Cable Corporation
311 Laura Drive
312-628-6100

LOUISIANA

Kenner 70062
Porter-Cable Corporation
2440 Veterans Memorial Hwy.
504-469-7363

MARYLAND

Baltimore 21205
Porter-Cable Corporation
4714 Erdman Avenue
301-483-3100

Hyattsville 20781

Porter-Cable Corporation
4811 Kenilworth Avenue
301-779-8060

MASSACHUSETTS

Boston (Allston) 02134
Porter-Cable Corporation
414 Cambridge Street
617-782-1700

MICHIGAN

Grand Rapids 49506
Porter-Cable Corporation
2750 Birchcrest Drive S.E.
616-949-9040

Southfield (Detroit) 48075
Porter-Cable Corporation
18650 W. Eight Mile Road
313-569-4333

MINNESOTA

Minneapolis 55429
Porter-Cable Corporation
4315 68th Avenue North
612-561-9080

MISSOURI

North Kansas City 64116
Porter-Cable Corporation
1141 Swift Avenue
P.O. Box 12393
816-221-2070

St. Louis 63139
Porter-Cable Corporation
2348 Hampton Avenue
314-968-8950

NEW JERSEY

Union 07083
Porter-Cable Corporation
945 Ball Avenue
201-964-1730

NEW YORK

Flushing 11365
Porter-Cable Corporation
175-25 Horace Harding Expwy.
212-225-2040

Syracuse 13224

Porter-Cable Corporation
2740 Erie Boulevard E.
315-445-1922

NORTH CAROLINA

Charlotte 28209
Porter-Cable Corporation
4612 South Boulevard
704-525-4410

OHIO

Cleveland 44146
Porter-Cable Corporation
5188 Richmond Road
216-675-1244

Columbus 43215

Porter-Cable Corporation
4560 Indiana Avenue
614-263-0929

OREGON

Portland 97212
Porter-Cable Corporation
51 N.E. Hancock
503-288-8888

PENNSYLVANIA

Bensalem 19020
Porter-Cable Corporation
Expressway 95
Industrial Center
3599 Meadow Lanes
215-638-4114

RHODE ISLAND

Providence 02914
Porter-Cable Corporation
1009 Waterman Avenue
401-434-3620

TEXAS

Dallas 75220
Porter-Cable Corporation
10714 N. Spemmons Freeway
214-353-2996

Houston 77092

Porter-Cable Corporation
5201 Mitchelldale, Suite B-9
713-882-0334

San Antonio 78218

Porter-Cable Corporation
2800 N.E. Loop 410
512-654-1061

UTAH

Salt Lake City 84115
Porter-Cable Corporation
2990 S.W. Temple
801-487-4953

VIRGINIA

Richmond 23220
Porter-Cable Corporation
1705 Dabney Road
804-257-7348

WASHINGTON

Renton 98055
Porter-Cable Corporation
268 Southeast 43rd Street
206-251-6680

WISCONSIN

Milwaukee 53222
Porter-Cable Corporation
10700 W. Burleigh Street
414-774-3650



**Delta Machinery
One Year Limited Warranty**

Delta Machinery will repair or replace, at its expense and at its option, any Delta machine, machine part, or machine accessory which in normal use has proven to be defective in workmanship or material, provided that the customer notifies his supplying distributor of the alleged defect within one year from the date of delivery to him, of the product and provides Delta Machinery with reasonable opportunity to verify the defect by inspection. Delta Machinery may require that electric motors be returned prepaid to the supplying distributor or authorized service center for inspection and repair or replacement. Delta Machinery will not be responsible for any asserted defect which has resulted from misuse, abuse or repair or alteration made or specifically authorized by anyone other than an authorized Delta service facility or representative. Under no circumstances will Delta Machinery be liable for incidental or consequential damages resulting from defective products. This warranty is Delta Machinery's sole warranty and sets forth the customer's exclusive remedy, with respect to defective products; all other warranties, express or implied, whether of merchantability, fitness for purpose, or otherwise, are expressly disclaimed by Delta.

Part No. 400-06-652-5002