

CRATE®



GTD65

**Three-Channel Guitar Amplifier
with DSP and Channel Tracking**



Owner's Manual

TABLE OF CONTENTS	
Introduction	3
Channel Tracking	4
The Front Panel	5
The Rear Panel	6
The DSP Section.....	7
Using the Footswitch with the DSP	8
Suggested Settings.....	9
System Block Diagram	10
Technical Specifications.....	12
Service Information	12

	CAUTION RISK OF ELECTRIC SHOCK DO NOT OPEN	
<small>WARNING: TO REDUCE THE RISK OF FIRE OR ELECTRIC SHOCK, DO NOT EXPOSE THIS APPARATUS TO RAIN OR MOISTURE. TO REDUCE THE RISK OF ELECTRIC SHOCK, DO NOT REMOVE COVER. NO USER-SERVICEABLE PARTS INSIDE. REFER SERVICING TO QUALIFIED SERVICE PERSONNEL.</small>		

	PRECAUCION RIESGO DE CORRIENTAZO NO ABRA	
<small>PRECAUCION: PARA REDUCIR EL RIESGO DE INCENDIOS O DESCARGAS ELECTRICAS, NO PERMITA QUE ESTE APARATO QUEDE EXPUESTO A LA LLUVIA O LA HUMEDAD. PARA DISMINUIR EL RIESGO DE CORRIENTAZO, NO ABRA LA CUBIERTA. NO HAY PIEZAS ADENTRO QUE EL USUARIO PUEDE REPARAR DEJE TODO MANTENIMIENTO A LOS TECNICOS CALIFICADOS.</small>		

	ATTENTION RISQUE D'ELECTROCUTION NE PAS OUVRIR	
<small>ATTENTION: PROTEGEZ CET APPAREIL DE LA PLUIE ET DE L'HUMIDITE AFIN D'EVITER TOUT RISQUE D'INCENDIE OU D'ELECTROCUTION. POUR REDUIRE D'ELECTROCUTION NE PAS ENLEVER LE COUVERCLE. AUCUNE PIECE INTERNE N'EST REPARABLE PAR L'UTILISATEUR. POUR TOUTE REPARATION, S'ADRESSER A UN TECHNICIEN QUALIFIE.</small>		

IMPORTANT SAFETY INSTRUCTIONS

- READ, FOLLOW, HEED, AND KEEP ALL INSTRUCTIONS AND WARNINGS.
- DO NOT OPERATE NEAR ANY HEAT SOURCE AND DO NOT BLOCK ANY VENTILATION OPENINGS ON THIS APPARATUS. FOR PROPER OPERATION, THIS UNIT REQUIRES 3" (75mm) OF WELL VENTILATED SPACE AROUND HEATSINKS AND OTHER AIR FLOW PROVISIONS IN THE CABINET.
- DO NOT USE THIS APPARATUS NEAR SPLASHING, FALLING, SPRAYING, OR STANDING LIQUIDS.
- CLEAN ONLY WITH LINT-FREE DAMP CLOTH AND DO NOT USE CLEANING AGENTS.
- ONLY CONNECT POWER CORD TO A POLARIZED, SAFETY GROUNDED OUTLET WIRED TO CURRENT ELECTRICAL CODES AND COMPATIBLE WITH VOLTAGE, POWER, AND FREQUENCY REQUIREMENTS STATED ON THE REAR PANEL OF THE APPARATUS.
- PROTECT THE POWER CORD FROM DAMAGE DUE TO BEING WALKED ON, PINCHED, OR STRAINED.
- UNPLUG THE APPARATUS DURING LIGHTNING STORMS OR WHEN UNUSED FOR LONG PERIODS OF TIME.
- ONLY USE ATTACHMENTS, ACCESSORIES, STANDS, OR BRACKETS SPECIFIED BY THE MANUFACTURER FOR SAFE OPERATION AND TO AVOID INJURY.
- WARNING: TO REDUCE THE RISK OF ELECTRIC SHOCK OR FIRE, DO NOT EXPOSE THIS UNIT TO RAIN OR MOISTURE.
- SERVICE MUST BE PERFORMED BY QUALIFIED PERSONNEL.
- OUR AMPLIFIERS ARE CAPABLE OF PRODUCING HIGH SOUND PRESSURE LEVELS. CONTINUED EXPOSURE TO HIGH SOUND PRESSURE LEVELS CAN CAUSE PERMANENT HEARING IMPAIRMENT OR LOSS. USER CAUTION IS ADVISED AND EAR PROTECTION IS RECOMMENDED IF UNIT IS OPERATED AT HIGH VOLUME.
- WARNING: THIS UNIT REQUIRES A SAFETY GROUNDED OUTLET WIRED TO CURRENT ELECTRIC CODES HAVING THE LINE SUPPLY VOLTAGE, POWER, AND FREQUENCY IDENTIFIED ON THE REAR OF THE UNIT. THE OUTLET MUST REMAIN ACCESSIBLE TO DISCONNECT THE UNIT IF A FAULT SHOULD ARISE WHILE IN USE. THIS UNIT SHOULD BE UNPLUGGED WHEN NOT IN USE.

EXPLANATION OF GRAPHICAL SYMBOLS:

EXPLICACION DE SIMBOLOS GRAFICOS:

EXPLICATION DES SYMBOLES GRAPHIQUES:



=

"DANGEROUS VOLTAGE"

"VOLTAJE PELIGROSO"

"DANGER HAUTE TENSION"



=

"IT IS NECESSARY FOR THE USER TO REFER TO THE INSTRUCTION MANUAL"

"ES NECESARIO QUE EL USUARIO SE REFIERA AL MANUAL DE INSTRUCCIONES."

"REFERREZ-VOUS AU MANUAL D'UTILISATION"

Introduction

Congratulations! You are now the proud owner of the Crate GTD65 three-channel guitar amplifier with advanced digital signal processing (DSP) and Channel Tracking. This rugged amplifier combines outstanding features with serious clean and distorted sounds. Digital Reverb, Chorus, and Delay provide you with a wide variety of sounds. Crate's unique Channel Tracking feature automatically stores your DSP settings for each channel to memory. As you switch from one channel to another, the DSP settings for the selected channel are instantly recalled. The supplied three-button footswitch allows you to select channels and change the DSP bank (Bank A/Bank B) by "remote control." A front panel 1/8" stereo CD input jack allows you to play along with your CD player, MP3 player, or iPod. A rear panel insert jack allows you to add even more effects by connecting an external effect processor.

Like all Crate products, your GTD amplifier is designed by musicians and built using only the best components. Extensive testing confirms that this amplifier is the absolute best it can be. In order to get the most out of your new amplifier, we strongly urge you to read this manual before you begin playing.

And **thank you** for choosing Crate.

Here are some of the features packed into your new GTD65 Combo Amplifier:

- 65 watts rms power output
- 1 x 12" speaker
- Three-Channel Operation
 - High Gain Channel
 - Overdrive Channel
 - Clean Channel
- 3-band EQ on the Overdrive and Clean Channels
- Proprietary "Shape" EQ control on the High Gain Channel
- DSP Effects including Delay, Chorus, and Reverb sections
- CD Input
- Effects Loop
- 3-Function Footswitch included
- External Speaker jack
- Built-in Chromatic Tuner

Channel Tracking

Your Crate GTD65 gives you the power of Channel Tracking. Once you select a DSP setting for each channel, Channel Tracking stores the settings to memory whenever you change channels. When you go back to that channel, Channel Tracking recalls those DSP settings automatically, without changing the DSP controls!

For example:

- Select the Clean channel. Set the Chorus control to “Flanger,” the Delay control to “Echo,” and adjust the Reverb control to your preference.
- Select the Overdrive channel. Set the Chorus control to “Chorus,” the Delay control to “Slap,” and readjust the Reverb control to a different setting. (The DSP settings for the Clean channel are now saved to memory.)
- Select the High Gain channel. Set the Chorus control to “Phaser,” the Delay control to “Echo/Eff,” and readjust the Reverb control once again. (The DSP settings for the Overdrive channel are now saved to memory.)
- Reselect the Clean channel. (The DSP settings for the High Gain channel are now saved to memory.)

When you reselected the Clean channel, the DSP settings previously stored in memory were automatically recalled. Switch to the Overload channel and the DSP settings you just stored are still there. You can change the DSP settings at any time. Once you set the DSP and select another channel, Channel Tracking stores the settings for you. Even when the amplifier is turned off, the DSP settings are stored and recalled the next time you turn it on. That’s the power of Channel Tracking!

In addition, each channel has two DSP banks, Bank A and Bank B, when you use the supplied three-button footswitch (see page 8 for more information on using the footswitch). Channel Tracking also remembers which DSP bank was selected for each channel.

The Front Panel

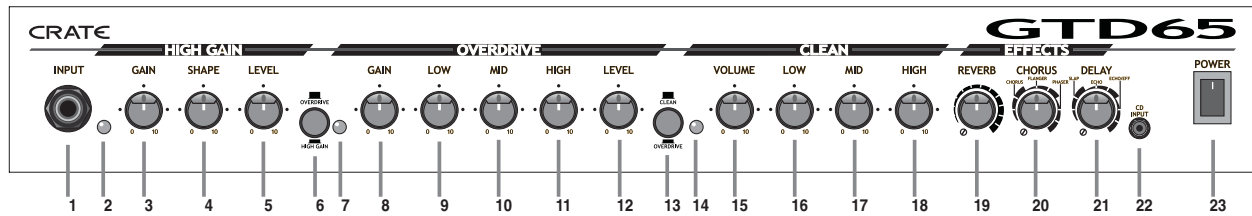

- 1. INPUT:** Use this jack to connect your guitar to the amplifier by means of a shielded instrument cable.
- 2. HIGH GAIN LED:** This LED illuminates when the High Gain channel is selected.
- 3. GAIN:** Use this control to adjust the amount of distortion for the High Gain channel.
- 4. SHAPE:** Use this control to “dial in” the tone for the High Gain channel. Rotating this control counter-clockwise enhances the mid frequencies, while rotating it clockwise enhances the low and high frequencies.
- 5. LEVEL:** Use this control to adjust the output level of the High Gain channel.
- 6. HIGH GAIN/OVERDRIVE:** Use this switch to select the High Gain or Overdrive channel. With the switch in the out position, the Overdrive channel is selected. When the switch is pushed in, the High Gain channel is selected. Note: This switch is only active when the Overdrive/Clean switch [13] is pushed in.
- 7. OVERDRIVE LED:** This LED illuminates when the Overdrive channel is selected.
- 8. GAIN:** Use this control to adjust the amount of distortion for the Overdrive channel.
- 9. LOW:** This adjusts the bass frequencies. Use this control to get the best sounding bass response for your instrument when using the Overdrive channel.
- 10. MID:** This adjusts the midrange frequencies. Use this control to get the best projection and midrange tones for your instrument when using the Overdrive channel.
- 11. HIGH:** This adjusts the treble frequencies. Use this control to attain a bright and lively sound for your instrument when using the Overdrive channel.
- 12. LEVEL:** Use this control to adjust the output level of the Overdrive channel.

- 13. OVERDRIVE/CLEAN:** Use this switch to select the Clean channel or the Overdrive and High Gain channels. With the switch in the out position, the Clean channel is selected. When the switch is pushed in, either the High Gain or Overdrive channel is selected, depending on the setting of the High Gain/Overdrive switch [6].
- 14. CLEAN LED:** This LED illuminates when the Clean channel is selected.
- 15. VOLUME:** Use this control to adjust the output level of the Clean channel.
- 16. LOW:** This adjusts the bass frequencies. Use this control to get the best sounding bass response for your instrument when using the Clean channel.
- 17. MID:** This adjusts the midrange frequencies. Use this control to get the best projection and midrange tones for your instrument when using the Clean channel.
- 18. HIGH:** This adjusts the treble frequencies. Use this control to attain a bright and lively sound for your instrument when using the Clean channel.
- 19-21. EFFECTS:** Use these controls to apply and adjust the DSP effects. Complete information on these effects is provided on page 7.
- 22. CD INPUT:** Use this 1/8" stereo mini jack to connect the output from a CD player, MP3 player, laptop, etc., to the amplifier. The signal at this jack is summed into a mono signal, which is sent to the internal power amp circuit. Use the output level control for the signal source to adjust the signal for the proper mix with your guitar.
- 23. POWER:** Use this switch to turn the amplifier on (top of the switch depressed) and off (bottom of the switch depressed). The switch illuminates when the amplifier is turned on.

The Rear Panel

This device complies with part 15 of the FCC Rules. Operation is subject to the following two conditions: (1) This device may not cause harmful interference, and (2) This device must accept any interference received, including interference that may cause undesired operation.

CN222

CAUTION: TO REDUCE THE RISK OF FIRE, REPLACE FUSE WITH SAME TYPE AND RATING.
ATTENTION: UTILISER UN FUSIBLE DE RECHANGE DE MEME TYPE.



100 VAC: 250V ~T.25A
120 VAC: 250V ~T2A
230/240 VAC: 250V ~T1.25A

24

24. FUSE: The fuse protects the amplifier from damage caused by a faulty AC power source or other problems. If the fuse opens, replace it with the same size and type. If fuses continue to fail, check the AC source. If the source is okay, refer to page 12 or contact your Crate dealer for service information.

25. EXTENSION SPEAKER: Use this jack to connect the amplifier to an external speaker cabinet. This jack is wired in series with the internal speaker, which remains active when an extension speaker is connected.

26. DSP FOOTSWITCH:

Use this jack to connect one of the footswitch cables to the three-button footswitch (supplied). This allows you to select between two DSP presets for each of the three channels. Additional information about the operation of the footswitch is on page 8.

27. CHANNEL

FOOTSWITCH: Use this jack to connect one of the footswitch cables to the three-button footswitch (supplied). This allows you to remotely switch between the Clean, High Gain, and Overdrive channels. Additional information about the operation of the footswitch is on page 8.

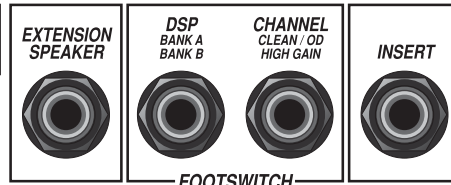

25

26

27

28

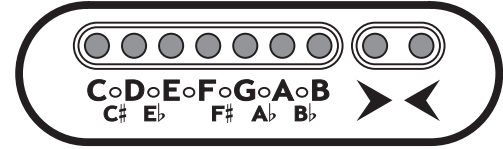

30

28. INSERT: Use this jack to connect an external signal processor to the amplifier. Use Crate's STP201, STP202, or STP203 stereo-to-mono Y-cord or an adapter such as Crate's YPP117 and two 1/4" mono signal cables to connect to the effect, as shown below.

29. POWER CORD (not shown): This grounded power cord is to be plugged into a grounded power outlet, wired to current electrical codes and compatible with the voltage, power, and frequency requirements stated on the rear panel. **Do not attempt to defeat the safety ground connection!**

30. ELECTRONIC TUNER (cabinet top)

The electronic tuner is active whenever the amplifier is turned on, providing constant "real-time" tuning. The row of red LEDs on the left indicates which note is being tuned.

When a single LED is lit, it represents the note that appears just below the LED. When two LEDs are lit, it represents the note that appears between them in the bottom row. The left green LED indicates the note is flat, and the right green LED indicates the note is sharp. The note is properly tuned when both LEDs are lit at the same time.

Stereo-to-mono Y-cord:

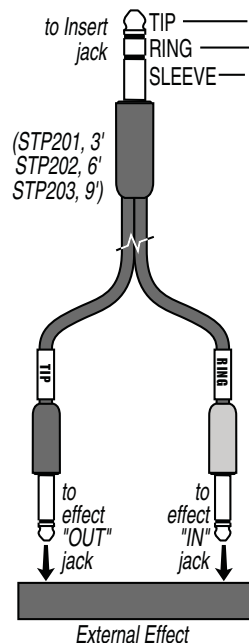

Y-adapter and 2 cables:

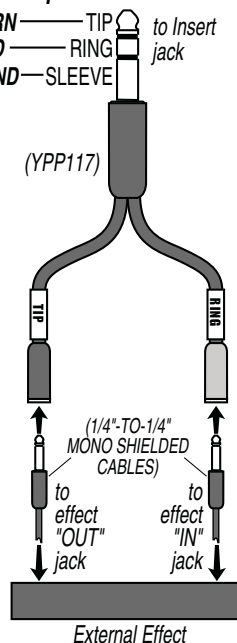

The DSP Section

Normal Signal Path
Chorus > Delay > Reverb

Echo/Eff Signal Path
Delay > Chorus > Reverb

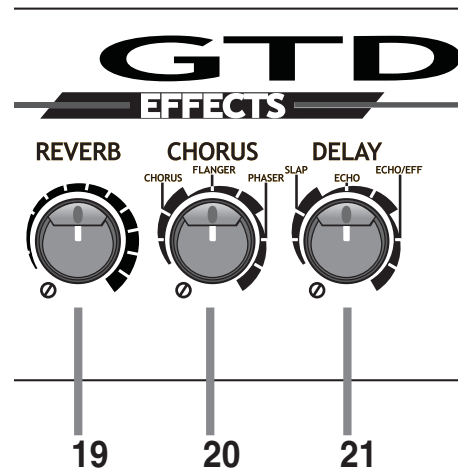

19. REVERB: Use this control to adjust the amount of digital reverb effect. In its fully counterclockwise position, the signal will be “dry” (without reverb). As you rotate this control clockwise, the amount of reverb increases.

20. CHORUS: Use this control to select the type of digital chorus effect. In its fully counterclockwise position, the signal will be “dry” (without chorus). As you rotate the control clockwise, you can select from three chorus

settings, three flanger settings, or three phaser settings. The chart below describes these effects.

21. DELAY: Use this control to select the type of digital delay effect. In its fully counterclockwise position, the signal will be “dry” (without chorus). As you rotate the control clockwise, you can select from three slap settings, three echo settings, or three echo with effect settings. The chart below describes these effects.

Effect Setting	Description
Chorus 1	Chorus with low depth
Chorus 2	Chorus with medium depth
Chorus 3	Chorus with high depth
Flanger 1	Flanger with low depth
Flanger 2	Flanger with medium depth
Flanger 3	Flanger with high depth
Phaser 1	Phaser with low feedback
Phaser 2	Phaser with medium feedback
Phaser 3	Phaser with high feedback
Slap 1	Single delay with low level
Slap 2	Single delay with medium level
Slap 3	Single delay with high level
Echo 1	Echo with low level
Echo 2	Echo with medium level
Echo 3	Echo with high level
Echo/Eff 1	Echo with low level before effect
Echo/Eff 2	Echo with medium level before effect
Echo/Eff 3	Echo with high level before effect

Using the Footswitch with the DSP

The Crate three-button footswitch supplied with the GTD65 allows access to an additional DSP preset for each channel of the amplifier. When the footswitch is connected to the amplifier as shown below, the “original” DSP presets are active for each channel when the #3 footswitch LED is illuminated. These are referred to as “DSP Bank A.” When the #3 button is switched and the LED is off, a second DSP preset may be stored and recalled for each channel — “DSP Bank B.”

Note: DSP Bank B presets are only accessible when the footswitch is connected to the amplifier. When the footswitch is not connected, only DSP Bank A is accessible.

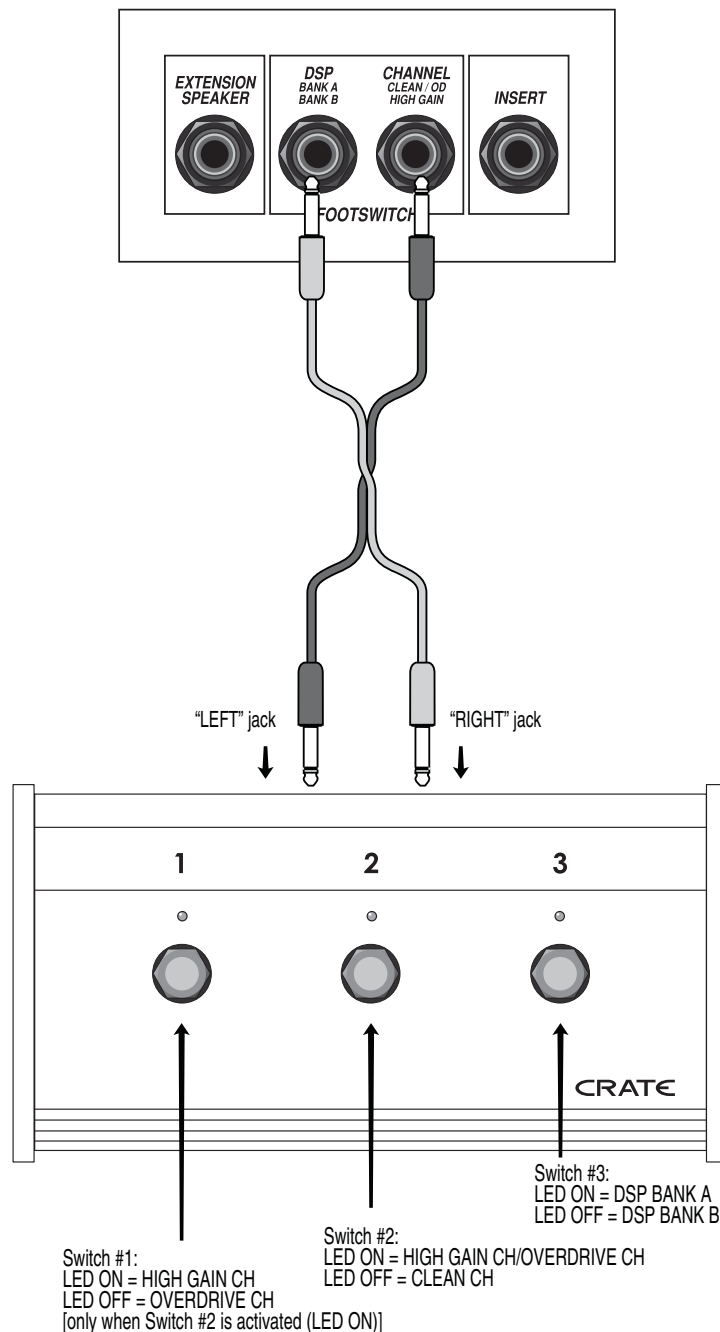

CRATE® GTD65 Guitar Amplifier w/DSP and Channel Tracking

Suggested Settings

Sweet 'n Clean:

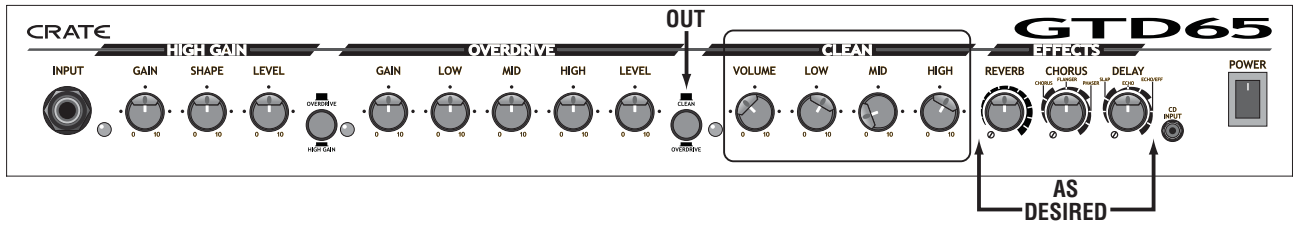

Just a 'Lil Nasty:

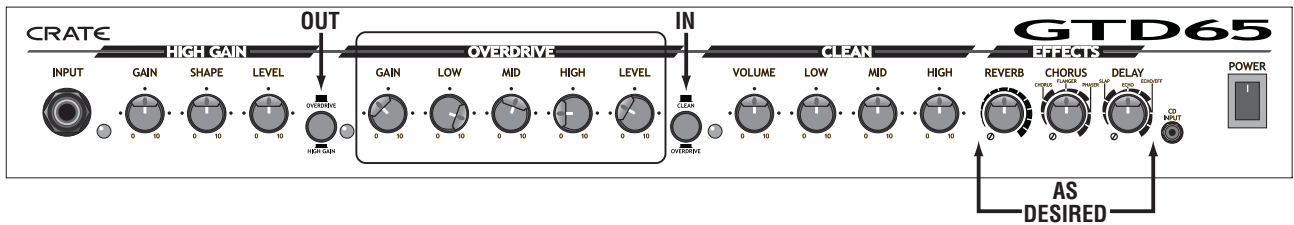

Politely Gritty:

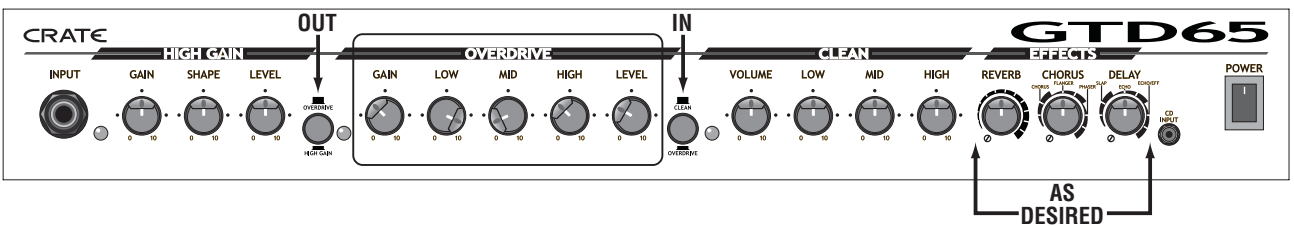

Down 'n Dirty:

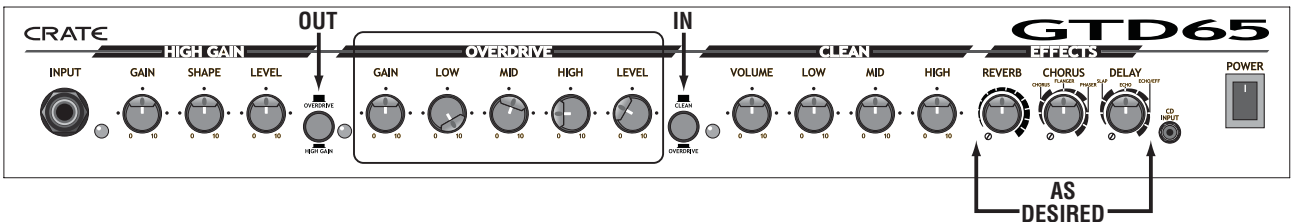

Mean & Obscene:

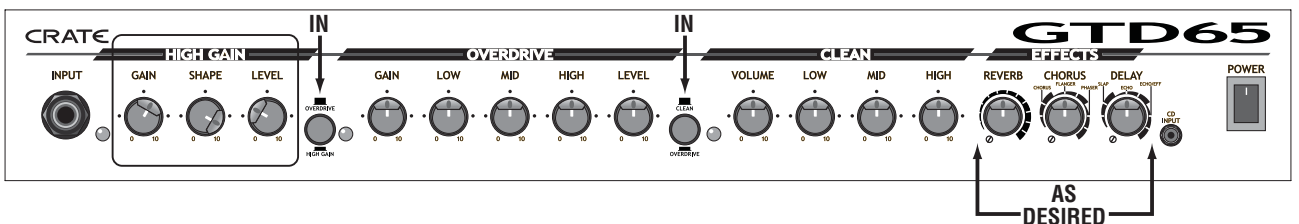

System Block Diagram

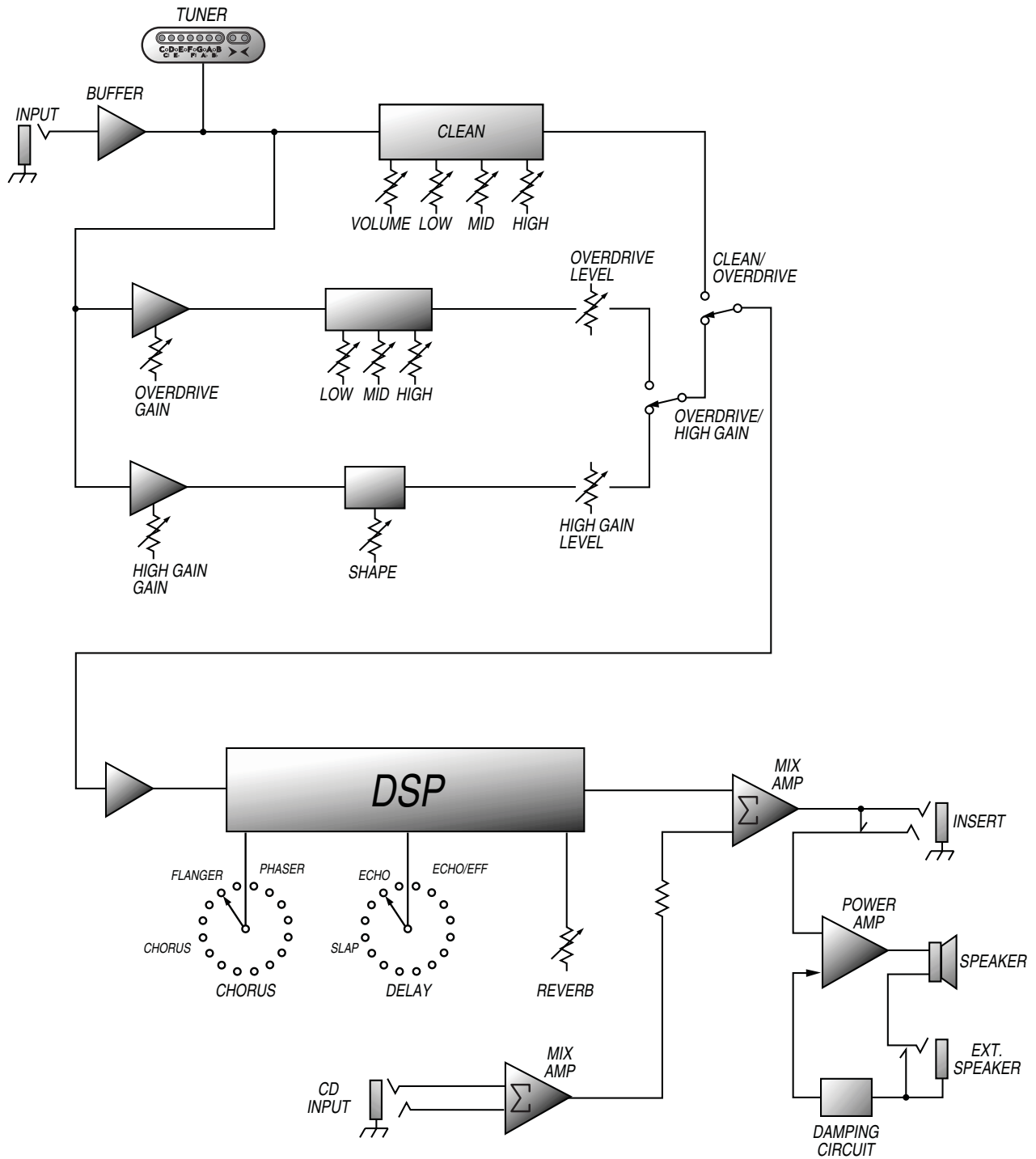

This equipment has been tested and found to comply with the limits for a Class B digital device, pursuant to part 15 of the FCC Rules. These limits are designed to provide reasonable protection against harmful interference in a residential installation. This equipment generates, uses, and can radiate radio frequency energy and, if not installed and used in accordance with the instructions, may cause harmful interference to radio communications. However, there is no guarantee that interference will not occur in a particular installation. If this equipment does cause harmful interference to radio or television reception, which can be determined by turning the equipment off and on, the user is encouraged to try to correct the interference by one or more of the following measures:

- Reorient or relocate the receiving antenna.
- Increase the separation between the equipment and the receiver.
- Connect the equipment into an outlet on a circuit different from that to which the receiver is connected.
- Consult the dealer or an experienced radio/TV technician for help.

Changes or modifications to this device not expressly approved by LOUD Technologies Inc. could void the user's authority to operate the equipment under FCC rules.

Declaration Of Conformity

Manufacturer:	LOUD Technologies Inc. 16220 Wood-Red Rd. NE Woodinville, WA 98072, USA
Product Name:	Crate GTD65
Product Type:	Audio Amplifier
Complies with Standards:	
LVD:	92/31/EEC, 93/68/EEC, & 73/23/EWG
Safety:	EN60065
EMC:	EN55013, EN55020, EN55022, EN55103, EN61000-3-2, & EN61000-3-3

The official Declaration of Conformity for this product is kept on file at:
LOUD Technologies Inc., 16220 Wood-Red Road NE, Woodinville, WA 98072 • Tel: 1-866-858-5832

CRATE® GTD65 Guitar Amplifier w/DSP and Channel Tracking

GTD65 TECHNICAL SPECIFICATIONS:

Output Power Rating		65W rms @ 5% THD, 8Ω, 120 VAC
Gain	High Gain Channel	110 dB, all controls @ 10
	Overdrive Ch	88 dB, all controls @ 10
	Clean Ch	58 dB, all controls @ 10
CD Input		29 dB
Maximum Input Signal Accepted		2.5 volts rms @ 400 Hz
Input Impedance		470k ohm
High Gain Channel	Shape Control	Proprietary Circuit
Overdrive Channel	Low	20 dB range @ 80 Hz
	Mid	15 dB range @ 1 kHz
	High	20 dB range @ 10 kHz
Clean Channel	Low	36 dB range @ 80 Hz
	Mid	15 dB range @ 800 Hz
	High	40 dB range @ 10 kHz
Speaker Size and Rating		12" Crate Custom Design 8 ohm
Power Requirements		120 VAC, 60 Hz, 95 VA
		100/115 VAC, 50/60 Hz, 95 VA
		230/240 VAC, 50/60 Hz, 95 VA
Size (H x W x D)		17.75 in/45.1 cm x 21.50 in/54.6 cm x
		12.50 in/31.8 cm
Weight		36 lb/16.3 kg

The GTD65 is covered with a durable Tolex material. Wipe it clean with a lint-free cloth. Never spray cleaning agents onto the cabinet. Avoid abrasive cleansers which would damage the finish.

Crate continually develops new products, as well as improves existing ones. For this reason, the specifications and information in this manual are subject to change without notice.

"Crate" is a registered trademark of LOUD Technologies Inc. All other brand names mentioned are trademarks or registered trademarks of their respective holders and are hereby acknowledged.

Service Information:

If you are having a problem with your GTD65, you can go to our website (www.crateamps.com) and click on Support for service information, or call 1-800-898-3211 during business hours (7 am to 5 pm PST, Monday-Friday). If you are outside of the U.S., contact your local distributor for technical support and service.

