

IMPORTANT MANUAL

Do Not Throw Away

SEARS

**Operator's
Manual**



Model No.
358.351080 - 18"
358.351160 - 16"
358.351180 - 18"

**CUSTOMER
ASSISTANCE
1-800-235-5878**

HOURS (CST)
Mon. - Sat. 7 a.m. - 7 p.m.
Sun. 10 a.m. - 7 p.m.



WARNING:
READ THE OPERATOR'S
MANUAL AND FOLLOW
ALL WARNINGS AND
SAFETY INSTRUCTIONS.
FAILURE TO DO SO CAN
RESULT IN SERIOUS
INJURY.

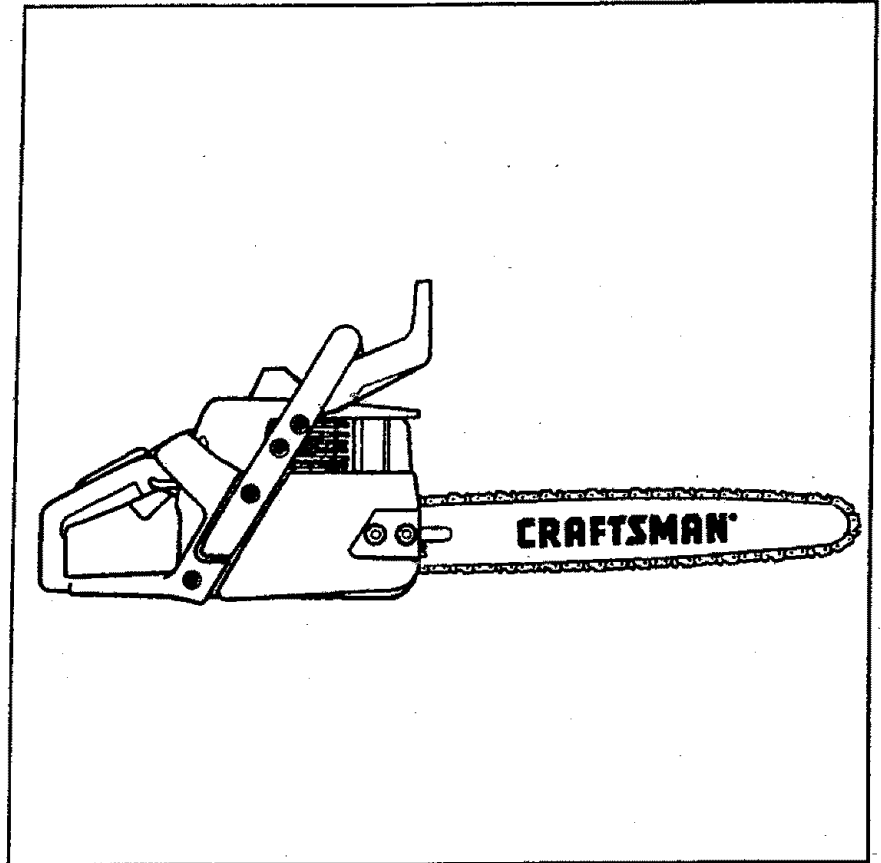

Always Wear Eye Protection

CRAFTSMAN®

**2.4 cu. in/40cc 2-CYCLE
2.4 cu. in/40cc 2-CYCLE
2.6 cu. in/42cc 2-CYCLE
GASOLINE CHAIN SAW**

- Assembly
- Operation
- Customer Responsibilities
- Service and Adjustments
- Repair Parts

Sears, Roebuck and Co., Hoffman Estates, IL 60179 U.S.A.

SAFETY RULES



WARNING:

ALWAYS DISCONNECT SPARK PLUG WIRE AND PLACE WIRE WHERE IT CANNOT CONTACT SPARK PLUG TO PREVENT ACCIDENTAL STARTING WHEN SETTING UP, TRANSPORTING, ADJUSTING OR MAKING REPAIRS EXCEPT CARBURETOR ADJUSTMENTS.

BECAUSE A CHAIN SAW IS A HIGH-SPEED WOOD-CUTTING TOOL, SPECIAL SAFETY PRECAUTIONS MUST BE OBSERVED TO REDUCE THE RISK OF ACCIDENTS. CARELESS OR IMPROPER USE OF THIS TOOL CAN CAUSE SERIOUS INJURY.

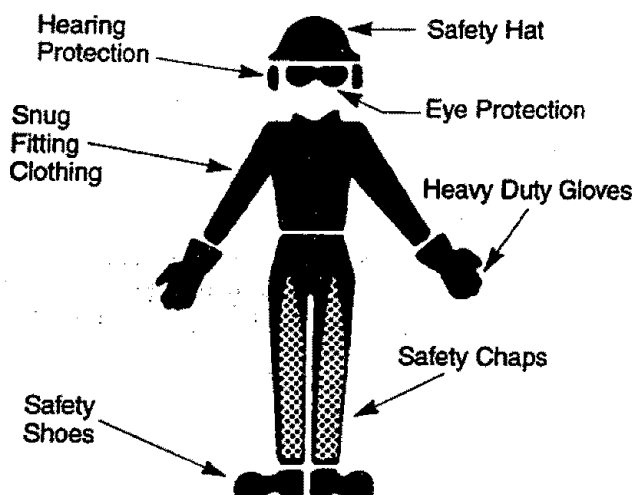

Figure 1

KNOW YOUR SAW

- Read your operator's manual carefully until you completely understand and can follow all safety rules, precautions, and operating instructions before attempting to operate the unit.
- Restrict the use of your saw to adult users who understand and can follow safety rules, precautions, and operating instructions found in this manual.

PLAN AHEAD

- Wear protective gear. Figure 1. Always use steel-toed safety footwear with non-slip soles; snug-fitting clothing; heavy duty, non-slip gloves; eye protection such as non-fogging, vented goggles or face screen; an approved safety hard hat; and sound barriers – ear plugs or mufflers to protect your hearing. Regular users should have hearing checked regularly as chain saw noise can damage hearing.
- Keep all parts of your body away from the chain when the engine is running.
- Keep children, bystanders, and animals a minimum of 30 feet (10 meters) away from the work area. Do not allow other people or animals to be near the chain saw when starting or operating the chain saw.

- Do not handle or operate a chain saw when you are fatigued, ill, or upset, or if you have taken alcohol, drugs, or medication. You must be in good physical condition and mentally alert. Chain saw work is strenuous. If you have any condition that might be aggravated by strenuous work, check with your doctor before operating a chain saw.
- Do not attempt to use your chain saw during bad weather conditions such as strong wind, rain, snow, ice, etc., or at night.
- Carefully plan your sawing operation in advance. Do not start cutting until you have a clear work area, secure footing, and, if you are felling trees, a planned retreat path.
- Do not operate a chain saw that is damaged, improperly adjusted, or not completely and securely assembled. Always replace the handguard immediately if it becomes damaged, broken, or is otherwise removed.
- Keep the handles dry, clean, and free of oil or fuel mixture.
- With the engine stopped, hand carry the chain saw with the muffler away from your body, and the guide bar and chain to the rear, preferably covered with a scabbard.

FUEL HANDLING

- Eliminate all sources of sparks or flames in the areas where fuel is mixed, poured, or stored. There should be no smoking, open flames, or wood that could cause sparks. Allow engine to cool before refueling.
- Mix and pour fuel in an outdoor area on bare ground; store fuel in a cool, dry, well ventilated place; and use an approved, marked container for all fuel purposes.
- Wipe up all fuel spills before starting saw.
- Move at least 10 feet (3 meters) from the fueling site before starting the engine.
- Do not smoke while handling fuel or while operating the saw.
- Turn the engine off and let your saw cool in a non-combustible area, not on dry leaves, straw, paper, etc. Slowly remove fuel cap and refuel unit.
- Store the unit and fuel in an area where fuel vapors cannot reach sparks or open flames from water heaters, electric motors or switches, furnaces, etc.

SAFETY NOTICE

Exposure to vibrations through prolonged use of gasoline powered hand tools could cause blood vessel or nerve damage in the fingers, hands, and joints of people prone to circulation disorders or abnormal swellings. Prolonged use in cold weather has been linked to blood vessel damage in otherwise healthy people. If symptoms occur such as numbness, pain, loss of strength, change in skin color or texture, or loss of feelings in the fingers, hands or joints, discontinue the use of this tool and seek medical attention. An anti-vibration system does not guarantee the avoidance of these problems. Users who operate power tools on a continual and regular basis must monitor closely their physical condition and the condition of this unit.



LOOK FOR THIS SYMBOL TO POINT OUT IMPORTANT SAFETY PRECAUTIONS. IT MEANS – ATTENTION!!! BECOME ALERT!!! YOUR SAFETY IS INVOLVED.

SAFETY RULES

OPERATE YOUR SAW SAFELY

- Do not operate a chain saw with one hand. Serious injury to the operator, helpers, bystanders or any combination of these persons may result from one-handed operation. A chain saw is intended for two-handed use.
- Operate the chain saw only in well-ventilated outdoor areas.
- Do not operate saw from a ladder or in a tree, unless specifically trained to do so.
- Position all parts of your body to the left of cut and away from the chain when the engine is running.
- Cut wood only. Do not use your saw to pry or shove away limbs, roots, or other objects.
- Make sure the chain will not make contact with any object while starting the engine. Never try to start the saw when the guide bar is in a cut or kerf.
- Use extreme caution when cutting small size brush and saplings. Slender material can catch the chain and be whipped toward you or pull you off balance.
- Be alert for springback when cutting a limb that is under tension so you will not be struck by the limb or saw when the tension in the wood fibers is released.
- Do not put pressure on the saw at the end of a cut. Applying pressure can cause you to lose control when the cut is completed.
- Stop the engine before setting the saw down.
- Keep fuel and oil caps, screws, and fasteners securely tightened.

MAINTAIN YOUR SAW IN GOOD WORKING ORDER

- Have all chain saw service performed by your Sears Service Center with the exception of the items listed in the "Customer Responsibilities" section of this manual. For example, if improper tools are used to remove or hold the flywheel when servicing the clutch, structural damage to the flywheel can occur and cause the flywheel to burst.
- Make certain the chain stops moving when the throttle trigger is released. For correction, refer to "Carburetor Adjustments."
- Stop the saw if the chain strikes a foreign object. Inspect unit and repair or replace parts as necessary.
- Disconnect the spark plug before performing any maintenance except for carburetor adjustments.
- Never modify your saw in any way. Use only SEARS accessories and replacement parts as recommended.

TRANSPORTING AND STORAGE

- Stop the unit before transporting.
- Allow engine to cool, cover the guide bar and chain, and secure the unit before storing or transporting in a vehicle.
- Empty fuel tank before storing or transporting the unit. Use up any fuel left in the carburetor by starting the engine and letting the engine run until it stops.
- Store unit and fuel in an area where fuel vapors cannot reach sparks or open flames from water heaters, electric motors or switches, furnaces, etc.
- Store unit so the chain cannot accidentally cause injury.
- Store the unit out of the reach of children.

GUARD AGAINST KICKBACK – Kickback is a dangerous reaction that can lead to serious injury.



KICKBACK WARNING: KICKBACK CAN OCCUR WHEN THE MOVING CHAIN CONTACTS AN OBJECT AT THE UPPER PORTION OF THE TIP OF THE GUIDE BAR OR WHEN THE WOOD CLOSES IN AND PINCHES THE CHAIN IN THE CUT. CONTACT AT THE UPPER PORTION OF THE TIP OF THE GUIDE BAR CAN CAUSE THE CHAIN TO DIG INTO THE OBJECT, WHICH STOPS THE CHAIN FOR AN INSTANT. THE RESULT IS A LIGHTNING FAST, REVERSE REACTION WHICH KICKS THE GUIDE BAR UP AND BACK TOWARD THE OPERATOR. IF THE CHAIN IS PINCHED ALONG THE TOP OF THE GUIDE BAR, THE GUIDE BAR CAN BE DRIVEN RAPIDLY BACK TOWARD THE OPERATOR. EITHER OF THESE REACTIONS CAN CAUSE LOSS OF SAW CONTROL WHICH CAN RESULT IN SERIOUS INJURY. DO NOT RELY ONLY ON THE SAFETY DEVICES PROVIDED WITH YOUR SAW. AS A CHAIN SAW USER, YOU MUST TAKE SPECIAL SAFETY PRECAUTIONS TO HELP KEEP YOUR CUTTING JOBS FREE FROM ACCIDENT OR INJURY.

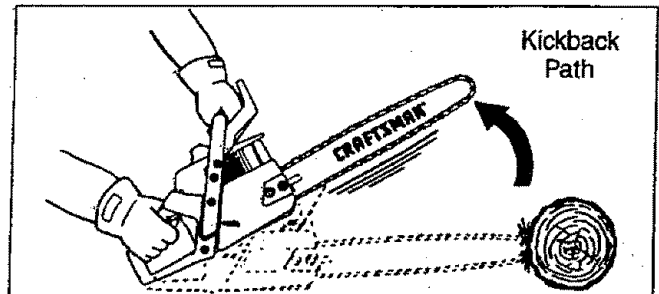

Figure 2

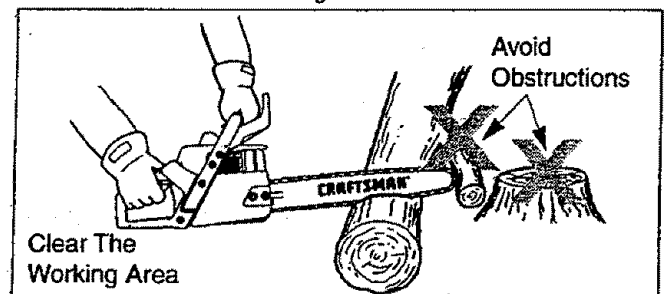

Figure 3

SAFETY RULES

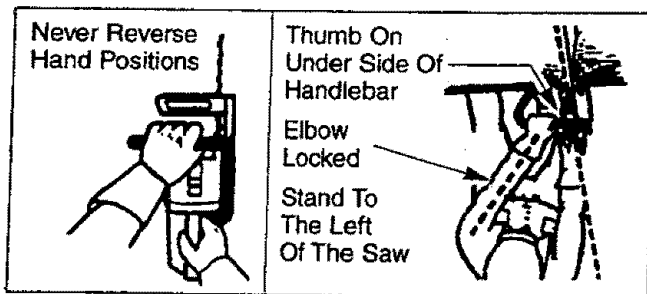

Figure 4

REDUCE THE CHANCE OF KICKBACK

- Recognize that kickback can happen. With a basic understanding of kickback, you can reduce the element of surprise which contributes to accidents.
- Never let the moving chain contact any object at the tip of the guide bar. Figure 2.
- Keep the working area free from obstructions such as other trees, branches, rocks, fences, stumps, etc. Figure 3. Eliminate or avoid any obstruction that your chain could hit while you are cutting through a particular log or branch.
- Keep your chain sharp and properly tensioned. A loose or dull chain can increase the chance of kickback to occur. Follow manufacturer's chain sharpening and maintenance instructions. Check tension at regular intervals with the engine stopped, never with the engine running. Make sure the bar clamp nuts are securely tightened after tensioning the chain.
- Begin and continue cutting at full throttle. If the chain is moving at a slower speed, there is greater chance for kickback to occur.
- Cut one log at a time.
- Use extreme caution when re-entering a previous cut.
- Do not attempt plunge cuts.
- Watch for shifting logs or other forces that could close a cut and pinch or fall into chain.
- Use the Reduced-Kickback Guide Bar and Low-Kickback Chain specified for your saw.

KICKBACK SAFETY FEATURES



WARNING:
THE FOLLOWING FEATURES ARE INCLUDED ON YOUR SAW TO HELP REDUCE THE HAZARD OF KICKBACK; HOWEVER, SUCH FEATURES WILL NOT TOTALLY ELIMINATE THIS DANGEROUS REACTION. AS A CHAIN SAW USER, DO NOT RELY ONLY ON SAFETY DEVICES. YOU MUST FOLLOW ALL SAFETY PRECAUTIONS, INSTRUCTIONS, AND MAINTENANCE IN THIS MANUAL TO HELP AVOID KICKBACK AND OTHER FORCES WHICH CAN RESULT IN SERIOUS INJURY.

- **Reduced-Kickback Guide Bar**, designed with a small radius tip which reduces the size of the kickback danger zone on the guide bar tip. Figure 5. A Reduced-Kickback Guide Bar is one which has been demonstrated to significantly reduce the number and seriousness of kickbacks when tested in accordance with ANSI B175.1-1991.
- **Low-Kickback Chain**, designed with a contoured depth gauge and guard link which deflect kickback force and allow wood to gradually ride into the cutter. Figure 5. Low-Kickback Chain is chain which has met kickback performance requirements of ANSI B175.1-1991 when tested on a representative sample of chain saws below 3.8 cubic

MAINTAIN CONTROL

- Keep a good, firm grip on the saw with both hands when the engine is running and don't let go. Figure 4. A firm grip can neutralize kickback and help you maintain control of the saw. Keep the fingers of your left hand encircling and your left thumb under the front handlebar. Keep your right hand completely around the rear handle whether you are right handed or left handed. Keep your left arm straight with the elbow locked.
- Position your left hand on the front handlebar so it is in a straight line with your right hand on the rear handle when making bucking cuts. Figure 4. Never reverse right and left hand positions for any type of cutting.
- Stand with your weight evenly balanced on both feet.
- Stand slightly to the left side of the saw to keep your body from being in a direct line with the cutting chain. Figure 4.
- Do not overreach. You could be drawn or thrown off balance and lose control of the saw.
- Do not cut above shoulder height. It is difficult to maintain control of saw above shoulder height.

UNDERSTANDING REACTIVE FORCES

Pinch-Kickback and Pull-In occur when the chain is suddenly stopped by being pinched, caught, or by contacting a foreign object in the wood. This stopping of the chain results in a reversal of the chain force used to cut wood and causes the saw to move in the opposite direction of the chain rotation. Either reaction can result in loss of control and possible serious injury.

- **Pinch-Kickback**
 - occurs when chain on top of guide bar is suddenly stopped.
 - rapidly drives saw straight back toward operator.
- **Pull-In**
 - occurs when the chain on the bottom of the guide bar is suddenly stopped.
 - pulls the saw rapidly forward.

inch displacement specified in ANSI B175.1-1991.

- **Handguard**, designed to reduce the chance of your left hand contacting the chain if your hand slips off the front handlebar.
- **Position of front and rear handlebars**, designed with distance between handles and "in-line" with each other. The spread and "in-line" position of the hands provided by this design work together to give balance and resistance in controlling the pivot of the saw back toward the operator if kickback occurs.
- ANSI B175.1-1991 - Safety requirements for gasoline powered chain saws as set by the American National Standards Institute, Inc., Standard B175.1-1991.

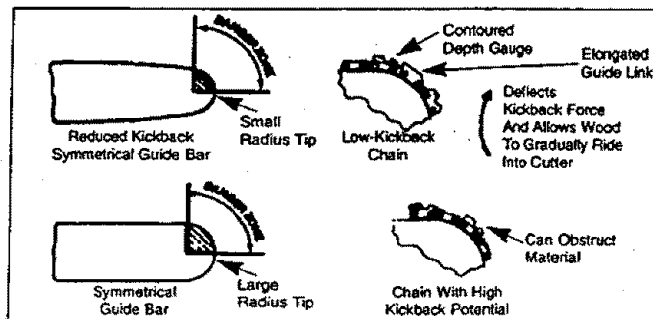

Figure 5

CONGRATULATIONS on your purchase of a Sears Craftsman Gasoline Chain Saw. It has been designed, engineered and manufactured to give you the best possible dependability and performance.

Should you experience any problems you cannot easily remedy, please contact your nearest Sears Service Center/Department or call the 1-800 number listed on the front of this manual. Sears has competent, well trained technicians and the proper tools to service or repair this unit.

Please read and retain this manual. The instructions will enable you to assemble and maintain your unit properly. Always observe the "SAFETY RULES."

MODEL NUMBER: **358.351080 - 18"**
 358.351160 - 16"
 358.351180 - 18"

DATE CODE/SERIAL NO.: _____

DATE OF PURCHASE: _____

THE MODEL AND SERIAL NUMBER WILL BE FOUND ON THE PRODUCT.

YOU SHOULD RECORD BOTH SERIAL NUMBER AND DATE OF PURCHASE AND KEEP IN A SAFE PLACE FOR FUTURE REFERENCE.

MAINTENANCE AGREEMENT

A Sears Maintenance Agreement is available on this product. Contact your nearest Sears Store for details.

CUSTOMER RESPONSIBILITIES

- Read and observe the safety rules.
- Follow a regular schedule in maintaining, caring for, and using your unit.
- Follow the instructions under "Customer Responsibilities" and "Storage" sections of this Operator's Manual.

PRODUCT SPECIFICATIONS

GUIDE BAR: 16"
 18"

CHAIN: Low Profile 3/8" Pitch
 Chrome Cutters

DISPLACEMENT: 2.4 Cubic Inches (40cc)
 2.6 Cubic Inches (42cc)

ENGINE: 2-cycle Air Cooled

FUEL MIX: 40:1 (3.2 oz. oil per gallon gas)

OILER: Automatic, 6.8 oz. Tank

IGNITION: Solid State
 (Air gap .010" to .014")

IGNITION TIMING: Non-adjustable, fixed

SPARK PLUG TYPE: .. Champion (CJ-7Y)

SPARK PLUG GAP:025" (.65mm)

MUFFLER: Spark Arresting Screen

ENGINE RPM: 12,600 RPM Maximum

SPECIAL NOTICE

Your saw is equipped with a temperature limiting muffler and spark arresting screen which meets the requirements of California Codes 4442 and 4443. All U.S. forest land and the states of California, Idaho, Maine, Minnesota, New Jersey, Washington, and Oregon require many internal combustion engines to be equipped with a spark arrester screen by law.

If you operate a chain saw in a state or locale where such regulations exist, you are legally responsible for maintaining the operating condition of these parts. Failure to do so is a violation of the law. Refer to the Spark Arrester section under "Customer Responsibilities" for maintenance.

MANUFACTURED UNDER ONE OR MORE OF THE FOLLOWING U.S. PATENTS: 5,367,988; 4,940,026; 4,370,855; 4,302,879; 4,197,640; D325,330. OTHER U.S. AND FOREIGN PATENTS PENDING.

SPECIAL NOTICE

If this saw is to be used for commercial logging, you must order and install a Chain Brake, to comply with Federal OSHA Regulations for Commercial Logging see Repair Parts List or call 1-800-235-5878.

FULL ONE YEAR WARRANTY ON CRAFTSMAN GAS CHAIN SAW

For one year from the date of purchase, when this Craftsman Gas Chain Saw is maintained, lubricated and tuned-up according to the owner's manual, Sears will repair, free of charge, any defect in material or workmanship.

This warranty excludes the bar, chain, spark plug and air filter, which are expendable parts, and become worn during normal use.

If this Gas Chain Saw is used for commercial or rental purposes, this warranty applies for 30 days from the date of purchase.

WARRANTY SERVICE IS AVAILABLE BY RETURNING THIS CHAIN SAW TO THE NEAREST SEARS SERVICE CENTER IN THE UNITED STATES.

This warranty gives you specific legal rights, and you may also have other rights which vary from state to state.

SEARS, ROEBUCK AND CO., D/817WA, Hoffman Estates, IL 60179

TABLE OF CONTENTS

Safety Rules.....2	Service and Adjustments.....22
Product Specifications.....5	Storage.....27
Warranty.....5	Trouble Shooting Points.....28
Accessories.....6	Repair Parts.....29
Operation.....8	Repair Parts Ordering/Service.....Back Cover
Customer Responsibilities.....17	





INDEX

<p>A</p> <p>Accessories.....6</p> <p>Air Filter.....20</p> <p>B</p> <p>Bar and Chain Oil.....10</p> <p>Bucking.....15</p> <p>C</p> <p>Carburetor Adjustments.....25</p> <p>Carton Contents.....7</p> <p>Chain Adjustment.....22</p> <p>Chain Oiler.....9</p> <p>Chain Sharpening.....18</p> <p>Customer Responsibilities.....17</p> <p>Spark Plug.....20</p> <p>E</p> <p>Engine</p> <p>Fuel/Oil.....10</p> <p>Spark Plug.....20</p> <p>Starting.....11</p> <p>Storage.....27</p> <p>F</p> <p>Fuel Filter.....21</p> <p>Fueling.....10</p> <p>G</p> <p>Guide Bar and Chain Oil.....10</p> <p>Guide Bar Maintenance.....19</p> <p>H</p> <p>How To Use Your Chain Saw.....9</p>	<p>K</p> <p>Know Your Chain Saw.....8</p> <p>L</p> <p>Limbing.....16</p> <p>M</p> <p>Maintenance Schedule.....17</p> <p>Model Number.....5</p> <p>Muffler.....20</p> <p>O</p> <p>Operation.....8</p> <p>Ordering Repair Parts.....Back Cover</p> <p>P</p> <p>Product Specifications.....5</p> <p>Pruning.....16</p> <p>R</p> <p>Repair Parts.....29</p> <p>S</p> <p>Service and Adjustments.....22</p> <p>Spark Arrestor Screen.....20</p> <p>Starter Rope.....23</p> <p>Starting.....11</p> <p>Storage.....27</p> <p>T</p> <p>Throttle Control Group.....9</p> <p>Tree Felling.....13</p> <p>Trouble Shooting Points.....28</p> <p>W</p> <p>Warranty.....5</p>
---	--



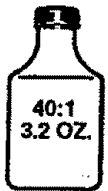



ACCESSORIES

These accessories and attachments were available when the unit was originally purchased. They are also available at most Sears retail outlets and service centers. Most Sears stores can order these items for you when you provide the model number of your unit.

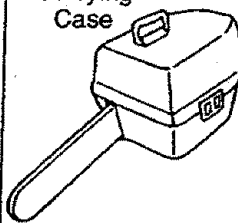
PERFORMANCE

<p>Spark Plug</p> 	<p>2-cycle Engine Oil</p>  <p>3.2 oz. 8 oz. 16 oz.</p>	<p>Air Filter</p> 	<p>Gas Can</p> 	<p>Bar Oil</p>  <p>1 qt. 1 gal.</p>
---	---	---	--	--

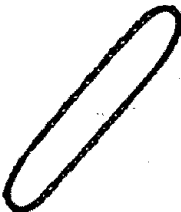
MAINTENANCE

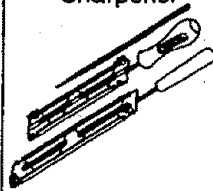
<p>Carrying Case</p> 	<p>Gloves</p> 	<p>Guide Bar</p> 	<p>Safety Goggles</p> 	<p>Chain</p> 	<p>Hearing Protection</p> 	<p>Chain Sharpener</p> 
--	---	--	---	---	---	--

CARTON CONTENTS

**MODEL 358.351080 - 18" ONLY
EXTRA CHAIN**

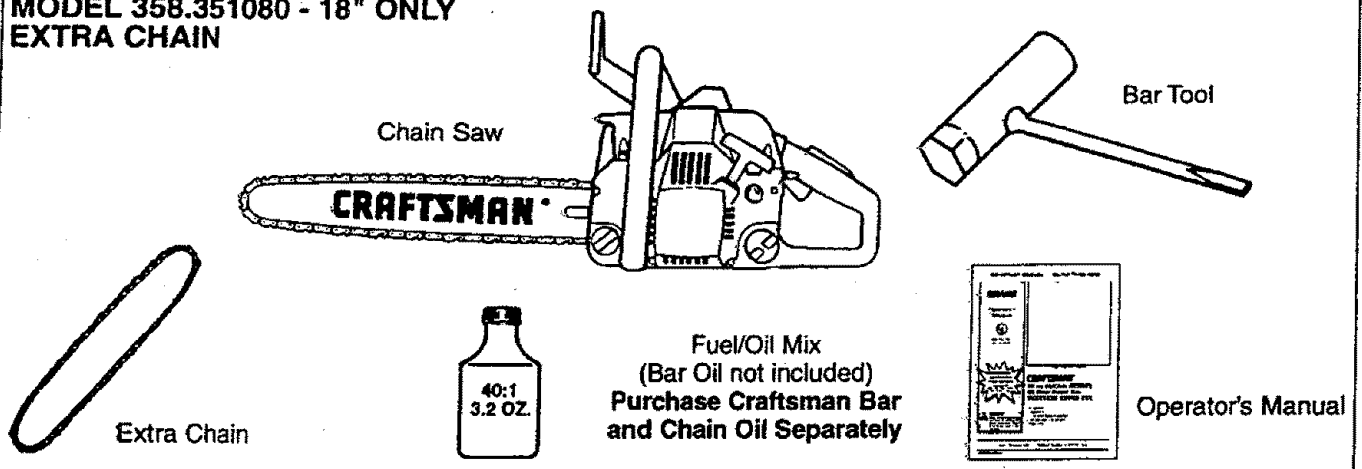

**MODEL 358.351160 - 16"
MODEL 358.351180 - 18"**

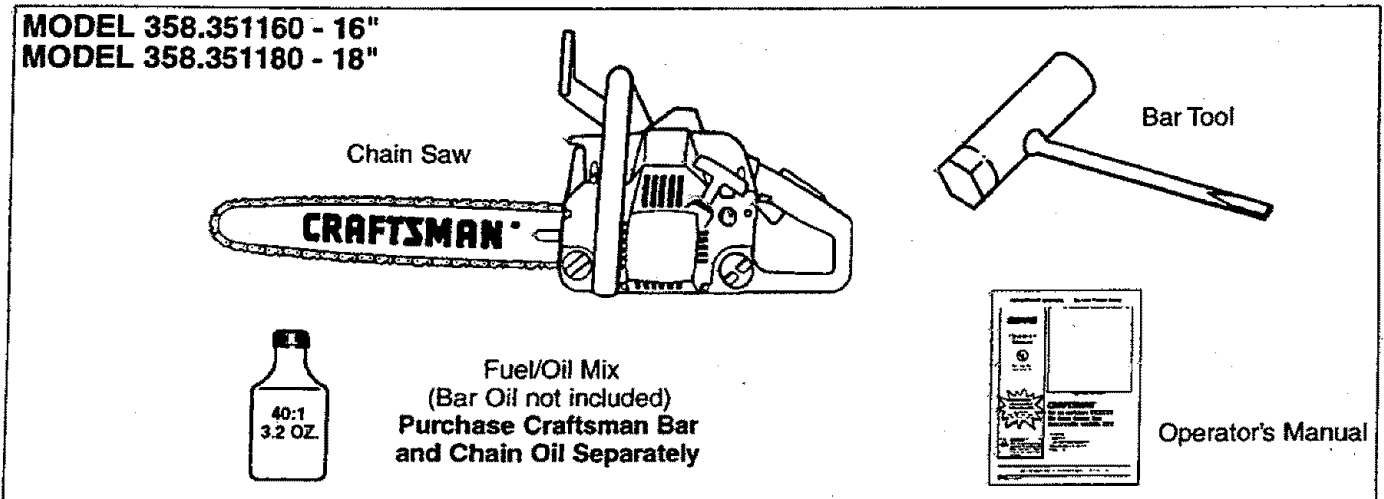

TOOLS REQUIRED FOR SERVICE

- Torque Wrench (optional) – Reference torque values are provided throughout this manual for tightening hardware.
- Bar Tool (included)

TO REMOVE CHAIN SAW FROM CARTON

- Remove loose parts bag included with Chain Saw.
- Remove your saw from the packing material.
- You may use the opened packing material as a work surface.

- After removing the contents from the carton, check parts against the Carton Contents.
- Examine the parts for damage. Do not use damaged parts.
- *If parts are missing or damaged please call the 1-800 number listed on the front of this manual.*

NOTE: It is normal to hear the fuel filter rattle in an empty fuel tank.

OPERATION

KNOW YOUR CHAIN SAW (Fig. 6)

READ THIS OPERATOR'S MANUAL AND SAFETY RULES BEFORE OPERATING YOUR CHAIN SAW. Compare the illustrations with your unit to familiarize yourself with the location of the various controls and adjustments. Save this manual for future reference.

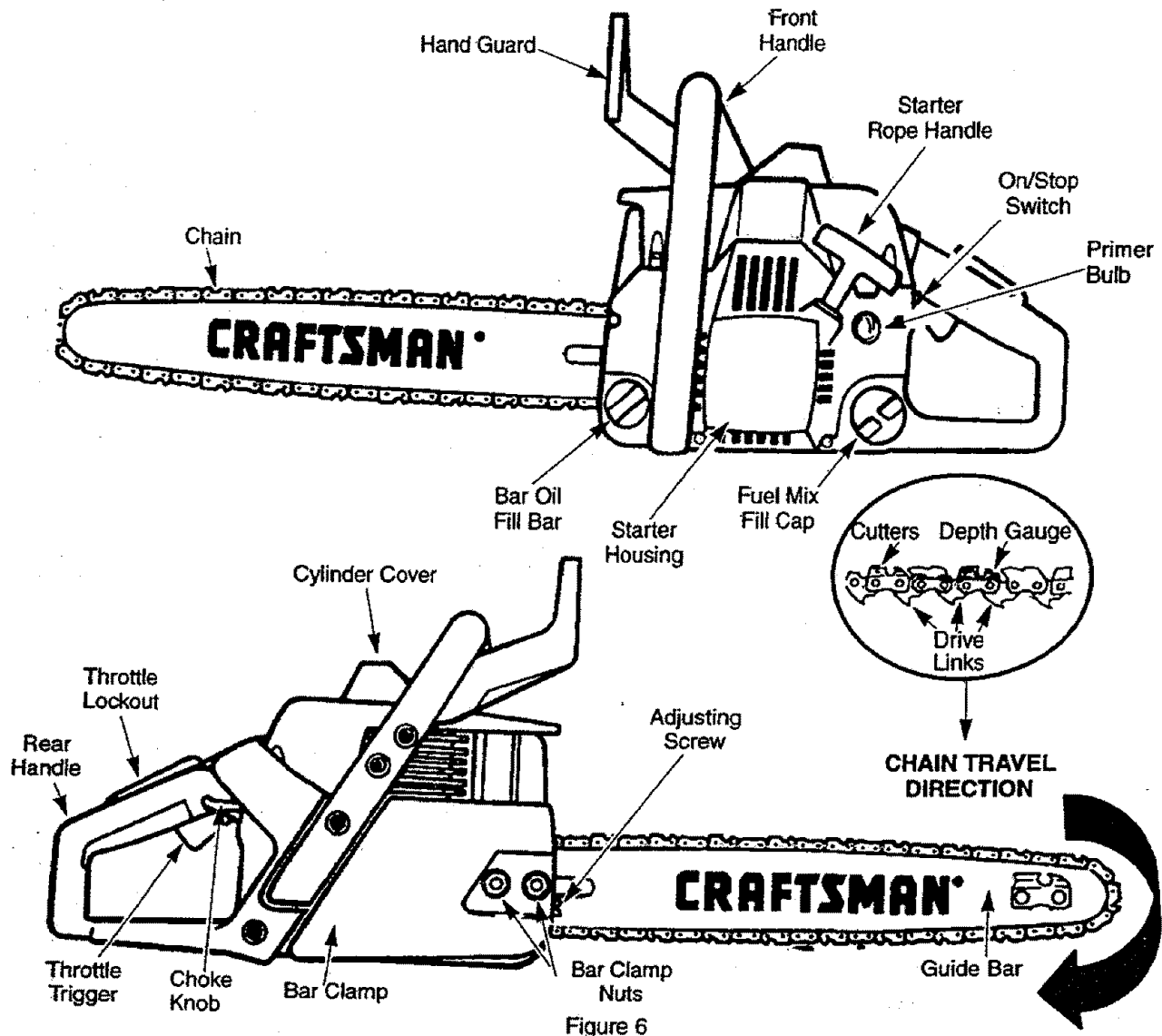

Figure 6

Listed by Underwriters Laboratories, Inc.
in accordance with American National Standards for Gasoline-Powered Chain Saws Safety Requirements
(ANSI B175.1-1991).

The ON/STOP SWITCH is used to stop the engine.

The STARTER ROPE HANDLE is used for starting the engine.

The CHOKE KNOB activates the choke to provide additional fuel to the engine when starting a cold engine.

The THROTTLE LOCKOUT prevents the THROTTLE TRIGGER from being squeezed accidentally.

The THROTTLE TRIGGER controls engine speed.

The GUIDE BAR is designed to carry the chain.

The CUTTERS are designed to cut the wood.

The BAR CLAMP NUTS are designed to hold the guide bar after adjustments have been completed.

The ADJUSTING SCREW is designed to tension the chain on the guide bar.

The PRIMER BULB circulates fuel to the carburetor.

OPERATION

HOW TO USE YOUR CHAIN SAW

STOPPING YOUR ENGINE

- Move on/stop switch to the "Stop" position.
- If engine does not stop, pull blue choke knob out fully.

CHAIN OILER (Fig. 7)

- The chain oiler provides continuous lubrication to the chain and guide bar. Be sure to fill the bar oil tank when you fill the fuel tank (Capacity = 6.8 fl. oz.).
- Your chain saw will consume approximately one tank of bar oil for each tank of fuel used.
- Your chain oiler is automatic and requires no adjustment.

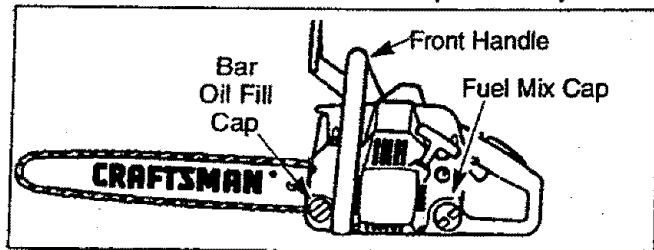

Figure 7

THROTTLE CONTROL GROUP (Fig. 8)

THROTTLE LOCKOUT

- The throttle lockout prevents unintentional actuation of the throttle trigger.
- You must depress the throttle lockout with the palm of your hand before actuating the throttle trigger.

THROTTLE TRIGGER

- The throttle trigger allows for variable control of engine speed.
- The throttle trigger is actuated by the index finger on your right hand. (After the throttle lockout is depressed).

CHOKE/FAST IDLE SPEED

- The choke and fast idle speed are set by pulling the choke lever out fully for cold or refueled engine starts.
- Squeezing the throttle trigger will release the choke and fast idle settings. If the throttle trigger is squeezed accidentally during starting, it will be necessary to reset throttle advance by pulling choke lever out fully.
- The choke provides additional fuel when starting a cold engine.
- The choke is actuated by pulling the blue choke knob.
- The choke has two positions: off and full.

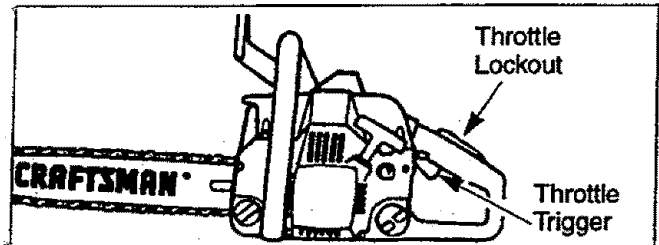

Figure 8

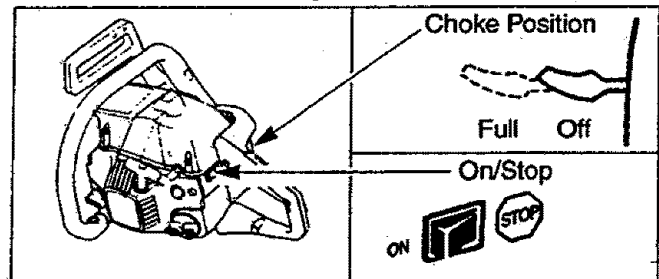

Figure 9

OPERATION

BEFORE STARTING ENGINE



WARNING:
BE SURE TO READ THE FUEL HANDLING INFORMATION IN THE SAFETY RULES SECTION ON PAGE 2 OF THIS MANUAL BEFORE YOU BEGIN.

IF YOU DO NOT UNDERSTAND THE FUEL HANDLING SECTION DO NOT ATTEMPT TO FUEL YOUR UNIT; SEEK HELP FROM SOMEONE THAT DOES UNDERSTAND THE FUEL HANDLING SECTION OR CALL THE CUSTOMER ASSISTANCE HOTLINE AT 1-800-235-5878.

GUIDE BAR AND CHAIN OIL

For maximum guide bar and chain life, we recommend you use Craftsman chain saw bar oil. If Craftsman bar oil is not available, you may use a good grade SAE30 oil until you are able to obtain Craftsman brand. The oil output is automatically metered during operation. Your saw will use approximately one tank of bar oil for every tank of fuel mix. **Always fill the bar oil tank when you fill the fuel tank.**

GASOLINE

The two-cycle engine on this product requires a fuel mixture of regular unleaded gasoline and a quality 40:1 2-cycle engine oil (AIR-COOLED) for lubrication of the bearings and other moving parts. The correct fuel/oil mixture is 40:1 (see Fuel Mixture Chart). Too little oil or the incorrect oil type will cause poor performance and may cause the engine to overheat and seize.

Gasoline and oil must be premixed in a clean approved fuel container. Always use fresh regular unleaded gasoline.

This engine is certified to operate on unleaded gasoline.

IMPORTANT: Experience indicates that alcohol blended fuels called gasohol (or using ethanol or methanol) can attract moisture, which leads to oil/gas separation and formation of acids during storage. Acidic gas can damage the fuel system of an engine while in storage. To avoid engine problems, the fuel system should be emptied before storage for 30 days or longer. Drain the gas tank, then run the fuel out of the carburetor and fuel lines by starting the engine and letting it run until it stops. Use fresh fuel next season. See STORAGE instructions for additional information. Never use engine or carburetor cleaner products in the fuel tank or permanent damage may occur.

FUEL STABILIZER

Fuel stabilizer is an acceptable alternative in minimizing the formation of fuel gum deposits during storage. Add stabilizer to gasoline in fuel tank or storage container. Always follow the fuel mix ratio found on the stabilizer container. Run engine at least 5 minutes after adding stabilizer to allow the stabilizer to reach the carburetor. You do not have to drain the fuel tank for storage if you are using fuel stabilizer.

CRAFTSMAN 40:1 2-cycle engine oil (AIR-COOLED) is specially blended with fuel stabilizers. If you do not use this Sears oil, you can add a fuel stabilizer to your fuel tank.

40:1 2-CYCLE AIR-COOLED ENGINE OIL

CRAFTSMAN 40:1 2-cycle engine oil (AIR-COOLED) is strongly recommended. This oil is specifically blended with fuel stabilizers for increased fuel stability (extends fuel life up to 5 times longer) and reduced smoke.

If CRAFTSMAN 40:1 2-cycle engine oil (AIR-COOLED) is not available, use a good quality 2-cycle engine oil (AIR-COOLED) that has a recommended fuel mix ratio of 40:1.

IMPORTANT! Do not use:

- AUTOMOTIVE OIL
- BOAT OILS (NMMA, BIA, etc.)

These oils do not have proper additives for 2-cycle (AIR-COOLED) engines and can cause engine damage.

GASOLINE AND OIL MIXTURE

MIX GASOLINE AND OIL AS FOLLOWS:

- Consult chart for correct quantities.
- Do not mix gasoline and oil directly in the unit's fuel tank.

FOR ONE GALLON:

- Pour 3.2 ounces of high quality, 40:1 2-cycle engine oil (AIR-COOLED) into an empty, approved one gallon gasoline container.
- Add one gallon of regular unleaded gasoline to the gallon container, then securely replace the cap.
- Shake the container momentarily.
- The mixture is now ready for use. Fuel stabilizer can be added at this time if desired; follow mixing instructions on the label.

FUEL MIXTURE CHART

40:1 Fuel:Oil Mix Ratio

Gasoline	Oil (fl.oz.)
1 gallon	3.2
2.5 gallons	8.0

NOTE: Fuel containers may hold more than the specified amount. If too much gasoline is in the container, the resulting gas-to-oil fuel mixture will not be correct for proper engine operation.

OPERATION

STOPPING YOUR ENGINE

- Move on/stop switch to the "Stop" position.
- If engine does not stop, pull blue choke knob out fully.



WARNING:
ALWAYS WEAR GLOVES, SAFETY FOOTWEAR, SNUG-FITTING CLOTHING, AND EYE, HEARING, AND HEAD PROTECTION DEVICES WHEN OPERATING A CHAIN SAW.

THE CHAIN MUST NOT MOVE WHEN THE ENGINE RUNS AT IDLE SPEED. REFER TO THE "CARBURETOR ADJUSTMENTS" SECTION FOR CORRECTION.

AVOID ANY CONTACT WITH THE MUFFLER. A HOT MUFFLER CAN CAUSE SERIOUS BURNS.

NOTE: Check chain tension using instructions in the "Service and Adjustment" section.

- Before first use.
- After 1 minute of operation.

TO START ENGINE (Fig. 10 & 11)

COLD ENGINE START AND WARM ENGINE START AFTER RUNNING OUT OF FUEL

- Fuel engine with 40:1 fuel mix (3.2 oz. to 1 gal. gas).
- Fill bar oil tank with bar oil. Your saw will use approximately one tank of bar oil for each tank of fuel mix.
- Prime engine by pressing primer bulb six times.
- Turn on ignition by moving on/stop switch to the "On" position.
- Pull the blue choke/fast idle control out fully to set both the choke and fast idle for starting. Then set the saw on the ground. Grip the front handle with your left hand and place your right foot through the opening in the rear handle.
- **IF THROTTLE TRIGGER IS SQUEEZED ACCIDENTALLY DURING STARTING IT WILL BE NECESSARY TO RESET THE CHOKE/FAST IDLE CONTROL.**

NOTE: When pulling the starter rope, do not use the full extent of the rope as this can cause the rope to break. Do not let the starter rope snap back, hold the handle and let the rope rewind slowly.

- Pull starter rope handle with your right hand until the engine attempts to start. Then push the blue choke knob in to the partial position. Resume pulling handle until engine starts.
- **Above 40 degrees**, allow engine to run for approximately 5 seconds, push the choke knob in to the "Off" position, then squeeze and release throttle trigger to allow engine to idle.
- **Below 40 degrees**, allow engine to warm up 30 seconds - 1 minute with choke at partial position. Push choke knob in to the "Off" position, then squeeze and release throttle trigger to allow engine to idle.
- To stop engine, move on/stop switch to the "Stop" position.

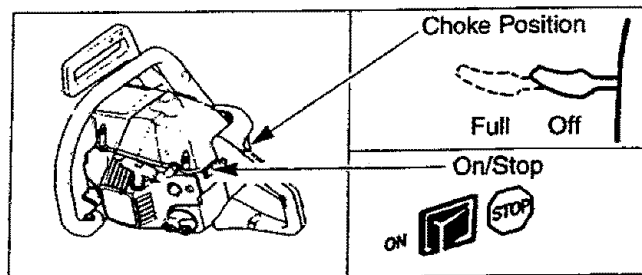

Figure 10

STARTING A WARM ENGINE

- Move on/stop switch to the "On" position.
- Engage the choke/fast idle by pulling out the blue choke knob fully and pushing it back in fully.
- Be sure choke is in the "Off" position.
- With saw on ground, grip front handle with left hand and place your right foot through opening in rear handle.
- Pull starter rope handle until engine starts.
- Squeeze and release throttle trigger to return engine to idle speed.

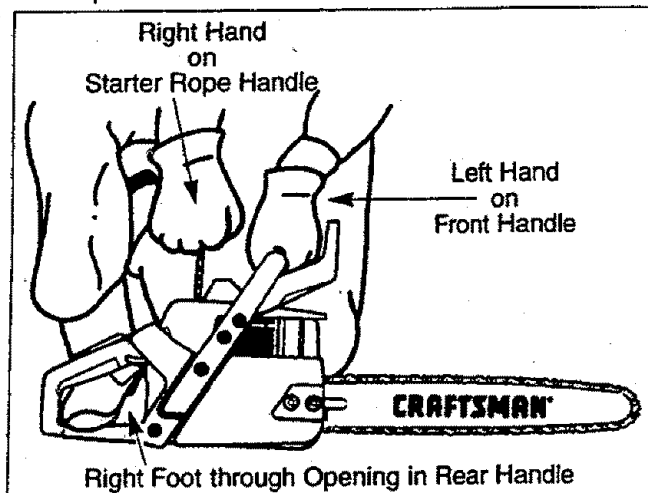

Figure 11

DIFFICULT STARTING OR FLOODED ENGINE

The engine may be flooded with too much fuel if it has not started after 10 pulls.

Flooded engines can be cleared of excess fuel with the following procedure:

- Pull out the blue choke/fast idle control fully and then push it back into the "Off" position to set the fast idle control to the start position.
- Verify that the on/stop switch is in the "On" position.
- Push the choke knob to the "Off" position.
- With saw on ground, grip front handle with left hand and place right foot through opening in rear handle.
- Pull starter rope handle until engine starts.

Starting could require pulling starter rope handle many times depending on how badly unit is flooded. If engine still fails to start, refer to "TROUBLE SHOOTING" chart or call the 1-800 number listed on the front page of this manual.

OPERATION

GENERAL OPERATION TIPS

- Cut wood only. Do not cut metal; plastics; masonry; non-wood building materials; etc.
- Stop the saw if the chain strikes a foreign object. Inspect the saw and repair or replace parts as necessary.
- Keep the chain out of dirt and sand. Even a small amount of dirt will quickly dull a chain and thus increase the possibility of kickback.

To get the "feel" of using your saw before you begin a major sawing operation, practice cutting a few small logs using the following technique:

- Accelerate engine to full throttle by squeezing the throttle trigger before entering cut.

- Never cut with engine at partial speeds.
- Begin cutting with the saw chassis against the log.
- Keep engine at full throttle during cutting procedure.
- Allow the chain to cut for you; exert only light downward pressure. If you force the cut, damage to the bar, chain, or engine can result.
- Release the throttle trigger as soon as the cut is completed, allowing the engine to idle. If you run the unit at full throttle without cutting, unnecessary wear can occur to the chain, bar, and engine.
- To avoid losing control when completing the cut, do not put pressure on the saw during the end of the cut.
- Stop engine before setting unit down after operation.

OPERATION SAFETY



WARNING:
IF SAW BECOMES PINCHED OR HUNG IN A LOG, DO NOT TRY TO FORCE IT OUT. YOU CAN LOSE CONTROL OF THE SAW RESULTING IN INJURY AND/OR DAMAGE TO THE SAW. STOP THE SAW, DRIVE A WEDGE OF PLASTIC OR WOOD INTO THE CUT UNTIL THE SAW CAN BE REMOVED EASILY. RESTART THE SAW AND CAREFULLY REENTER THE CUT. TO AVOID KICKBACK AND CHAIN DAMAGE, DO NOT USE A METAL WEDGE. DO NOT ATTEMPT TO RESTART YOUR SAW WHEN IT IS PINCHED OR HUNG IN A LOG.

KICKBACK CAN OCCUR WHEN THE MOVING CHAIN CONTACTS AN OBJECT AT THE UPPER PORTION OF THE TIP OF THE GUIDE BAR OR WHEN THE WOOD CLOSES IN AND PINCHES THE SAW CHAIN IN THE CUT. CONTACT AT THE UPPER PORTION OF THE TIP OF THE GUIDE BAR CAN CAUSE THE CHAIN TO DIG INTO THE OBJECT AND STOP THE CHAIN FOR AN INSTANT. THE RESULT IS A LIGHTNING FAST, REVERSE REACTION WHICH KICKS THE GUIDE BAR UP AND BACK TOWARD THE OPERATOR. IF THE SAW CHAIN IS PINCHED ALONG THE TOP OF THE GUIDE BAR, THE GUIDE BAR CAN BE DRIVEN RAPIDLY BACK TOWARD THE OPERATOR. EITHER OF THESE REACTIONS CAN CAUSE LOSS OF SAW CONTROL WHICH CAN RESULT IN SERIOUS INJURY.

AVOID REACTIVE PINCH FORCES

Pinch-Kickback and Pull-In occur when the chain is suddenly stopped by being pinched, caught, or by contacting a foreign object in the wood. This sudden stopping of the chain results in a reversal of the chain force used to cut wood and causes the saw to move in the opposite direction of the chain rotation. Pinch-Kickback drives the saw straight back toward the operator. Pull-In pulls the saw away from the operator. Either reaction can result in loss of control and possibly serious injury.

TO AVOID PINCH-KICKBACK:

- Be extremely aware of situations or obstructions that can cause material to pinch the top of or otherwise stop the chain.
- Do not cut more than one log at a time.
- Do not twist the saw as the bar is withdrawn from an under-cut when bucking.

TO AVOID PULL-IN:

- Always begin cutting with the engine at full throttle and the saw housing against wood.
- Use wedges made of plastic or wood, (never of metal) to hold the cut open.

OPERATION

TREE FELLING



WARNING:
IF THE TRUNK OR LIMBS ARE ROTTING,
THEY CAN FALL UNEXPECTEDLY AND
CAUSE SERIOUS INJURY.

AS YOU MAKE YOUR FELLING CUT, IF THE SAW APPEARS TO BE BINDING, THE TREE IS STARTING TO FALL IN THE WRONG DIRECTION. IMMEDIATELY STOP THE SAW AND USE A FELLING WEDGE AND MAUL (HAMMER) TO FORCE THE FELLING CUT OPEN. THE WEDGE WILL HOLD THE FELLING CUT OPEN ALLOWING YOU TO REMOVE THE SAW. KEEP EVERYONE AWAY FROM THE TREE IN ALL DIRECTIONS.

DETERMINE THE NATURAL FALL DIRECTION

- Wind – A tree evenly balanced will fall in the same direction the wind is blowing.
- Lean – Use a carpenter's level or plumb bob to determine if tree has a natural lean. A leaning tree will tend to fall in direction of lean.
- Shape – A tree will tend to fall towards side that is more heavily branched.
- Other Factors – Contacting or nearby trees, buildings, or wires can influence the direction the tree will fall.

CUTTING PROCEDURE (Fig. 12)

After determining the Natural Fall Direction, the tree should be cut as follows:

- IMPORTANT: BEFORE FELLING A TREE, MAKE SURE YOU HAVE AT LEAST 3 FELLING WEDGES AND A MAUL (HAMMER) AVAILABLE FOR USE IF NEEDED.**
- Use some means to visually mark the Natural Fall Direction.
 - Mark your notch cut on the Natural Fall Direction side of the tree approximately 18-24 inches above the ground.
 - Cut top of the notch first at a 45 degree angle. Saw through 1/3 of the width of the tree.
 - Cut bottom of the notch at a 45 degree angle until you meet the top notch cut. Remove notch of wood.
 - On the side of the tree opposite the notch cut, make the felling cut. The felling cut should be 2 inches above the center point of the notch cut. Before the felling cut is complete, use wedges to open the cut when necessary to control the direction of the fall. Use wood or plastic wedges, but *never* steel or iron, to avoid kickback and chain damage.
 - Cracking sounds, widening of the felling cut, movement in the upper branches are all signs that the tree is ready to fall.
 - As tree begins to fall, turn off saw, and move quickly away from direction of fall.

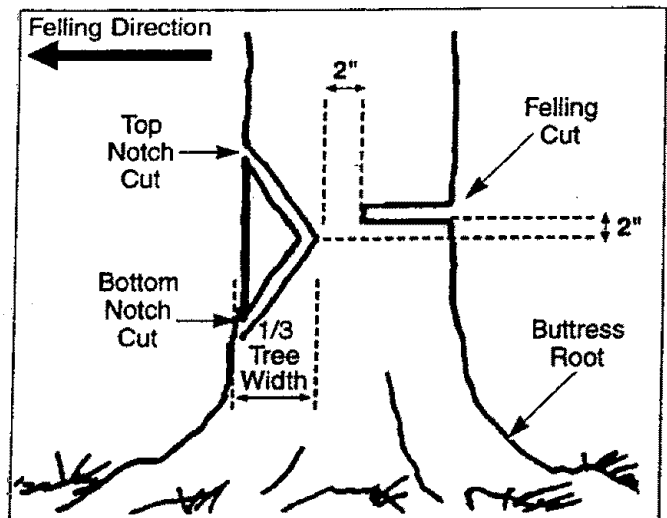

Figure 12

If your chain saw binds in the felling cut, you have three options:

- If the wrong direction of fall is acceptable, carefully remove the felling wedge. Cut deeper in the notch side of the tree until tree starts to fall.
- If the wrong direction of fall is **not** acceptable, attempt to use one or more felling wedges to force the tree in the original direction of fall. Do so by driving the wedges deeper into the felling cut.
- Keep everyone away from the tree in all directions and then seek professional help!

FELLING TIPS

- Clear the work area of debris where you can have secure footing.
- Make sure there is enough room for the tree to fall. Maintain a distance of 2 1/2 tree lengths from the nearest person or other objects. Engine noise can drown out a warning call.
- Remove dirt, stones, loose bark, nails, staples, and wire from the tree where cuts are to be made.
- Plan to stand on the up-hill side when cutting on a slope.
- Plan a clear retreat path to the rear and diagonal to the line of fall.
- Large buttress roots should be removed prior to notch cut.
- Use a wedge if there is any chance that the tree will not fall in the desired direction.
- We recommend you cut branches below shoulder height before felling tree. (See Limbing and Pruning).

Be alert to signs that the tree is ready to fall:

- Cracking sounds.
- Widening of the felling cut.
- Movement in the upper branches.

OPERATION SAFETY

FELLING SAFETY

DON'T PUT YOURSELF IN THESE POSITIONS

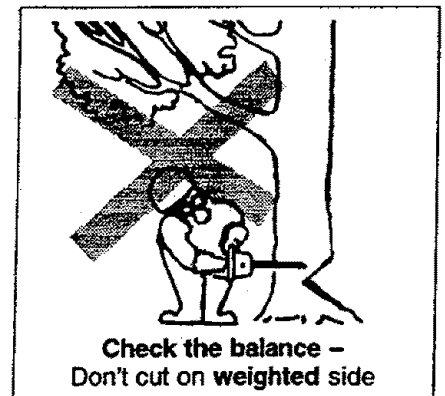

 **WARNING:**
DO NOT CUT:
- NEAR ELECTRICAL WIRES OR BUILDINGS.
- IF YOU DO NOT KNOW THE DIRECTION OF TREE FALL.
- AT NIGHT.
- DURING BAD WEATHER - RAIN, SNOW, STRONG WIND, ETC.

- **Look for decay and rot.** If the trunk is rotted, it can snap and fall toward the operator.
- **Check for broken or dead branches** which can fall on you while cutting.
- Be extremely cautious with partially fallen trees that may be poorly supported. When a tree doesn't fall completely, set the saw aside and pull down the tree with a cable winch, block and tackle, or tractor. To avoid injury, do not cut down a partially fallen tree with your saw.

OPERATION

BUCKING

Bucking is cutting a fallen tree to the desired log size.

TYPES OF CUTTING (Fig. 13)

- Overcutting – begin on the top side of the log with the bottom of the saw chassis against the log; exert light pressure downward.
- Undercutting – begin on the underside of the log with the top of the saw chassis against the log; exert light pressure upward. During undercutting, the saw will tend to push back at you. Be prepared for this reaction and hold the saw firmly to maintain control.

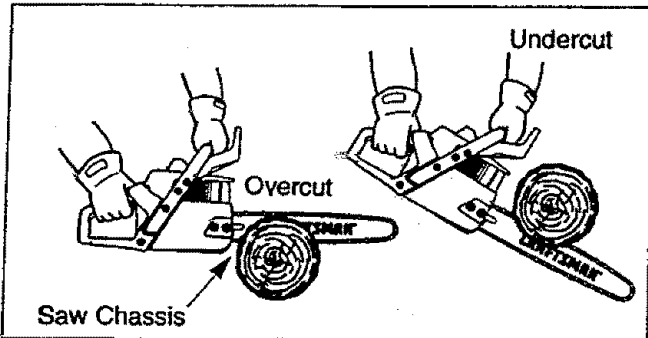

Figure 13

BUCKING ON THE GROUND (Fig. 14)

- Overcut with a 1/3 diameter cut.
- Roll log over and finish with an overcut.

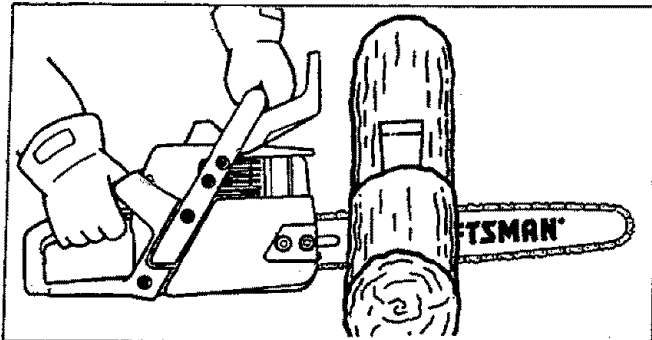

Figure 14

BUCKING USING A SUPPORT (Fig. 15 & 16)

Another log or a stand, such as a sawhorse, may be used as supports when bucking.

- Area A – Undercut 1/3 of the way through the log.
 - Finish with an overcut.
- Area B – Overcut 1/3 of the way through the log.
 - Finish with an undercut.

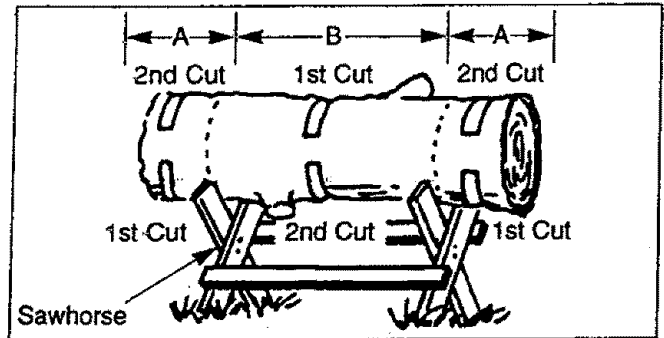

Figure 15

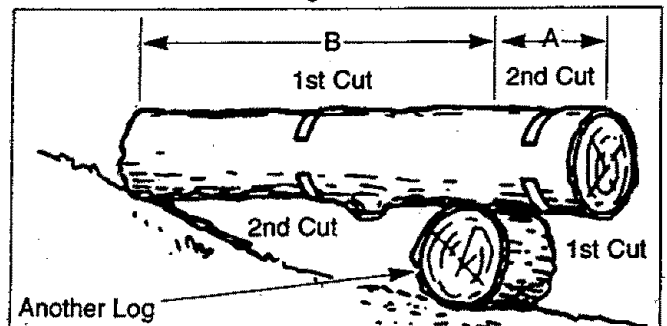

Figure 16

BUCKING TIPS

- Cut only one log at a time.
- Cut shattered wood very carefully. Sharp pieces of wood could be flung toward the operator.
- Use a sawhorse to cut small logs. Never allow another person to hold the log while cutting and never hold the log with your leg or foot.
- Do not cut in an area where logs, limbs, and roots are tangled such as in a blown down area. Drag the logs into a clear area before cutting by pulling out exposed and cleared logs first.
- Give special attention to logs under strain to prevent the saw from pinching. Make the first cut on the pressure side to relieve the stress on the log.

OPERATION SAFETY

BUCKING SAFETY



WARNING:
DO NOT STAND ON THE LOG BEING CUT. ANY PORTION CAN ROLL CAUSING LOSS OF FOOTING AND CONTROL.

NEVER TURN THE SAW UPSIDE DOWN TO UNDERCUT. THE SAW CANNOT BE CONTROLLED IN THIS POSITION.

- Stay on uphill side of tree when cutting.



Use Common Sense

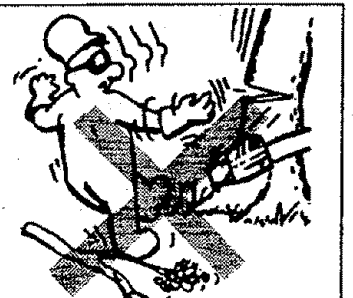

Maintain Secure Footing

OPERATION

PRUNING AND LIMBING

Pruning is removing branches from a standing tree.
Limbing is removing branches from a felled tree.

LIMBING (Fig. 17)

- Start at base of the felled tree and work toward the top.
- Leave the larger limbs underneath the felled tree to support the tree as you work.



Figure 17

PRUNING (Fig. 18)

Small branches – smaller than width of guide bar.
Large branches – larger than width of guide bar.

- Remove small limbs with one cut.
- Remove larger, supporting branches with the 1/3 - 2/3 cutting techniques described in the bucking section.

PRUNING PROCEDURE

- Cut 1 – Undercut 1/3 of the way through the limb near the trunk of the tree.
- Cut 2 – Finish with an overcut farther out from the trunk until the limb falls. Keep out of the way of the falling limb.
- Pruning Cut – Cut the limb stump flush at the edge of the collar.

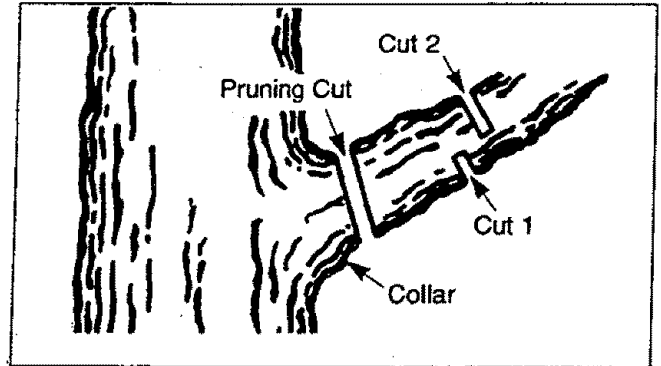

Figure 18

PRUNING AND LIMBING TIPS

- Work slowly, keeping both hands firmly gripped on the saw. Maintain secure footing and balance.
- Keep a clear work area. Frequently clear branches out of the way to avoid tripping over them.
- Leave the larger limbs underneath the felled tree to support the tree as you work.
- Start at the base of the felled tree and work toward the top.
- Keep the tree between you and the chain. Cut from the side of the tree opposite the branch you are cutting.
- Limit pruning to limbs shoulder height or below.
- Keep out of the way of the falling limb.

OPERATION SAFETY

PRUNING AND LIMBING SAFETY



WARNING:
NEVER CLIMB INTO A TREE TO LIMB OR PRUNE UNLESS SPECIFICALLY TRAINED TO DO SO. DO NOT STAND ON LADDERS, PLATFORMS, A LOG, OR IN ANY POSITION WHICH CAN CAUSE YOU TO LOSE YOUR BALANCE OR CONTROL OF THE SAW.

BE ALERT FOR AND GUARD AGAINST KICKBACK. DO NOT ALLOW THE MOVING CHAIN TO CONTACT ANY OTHER BRANCHES OR OBJECTS AT THE NOSE OF THE GUIDE BAR WHEN LIMBING OR PRUNING. ALLOWING SUCH CONTACT CAN RESULT IN SERIOUS INJURY.

DO NOT CUT IF BRANCHES ARE HIGHER THAN YOUR SHOULDER. GET A PROFESSIONAL TO DO THE JOB. THIS MAY RESULT IN SERIOUS INJURY.

- **Watch out for springpoles.** Use extreme caution when cutting small size limbs. Slender material may catch the saw chain and be whipped toward you or pull you off balance.
- **Be alert for springback.** Watch out for branches that are bent or under pressure as you are cutting to avoid being struck by the branch or the saw when the tension in the wood fibers is released.

CUSTOMER RESPONSIBILITIES

MAINTENANCE SCHEDULE

Fill in dates as you complete regular service	Before Use	After Use	Every 5 Hrs.	Every 25 Hrs.	Yearly	Service Dates			
Check for damaged or worn parts	✓								
Check for loose fasteners and parts	✓								
Check chain tension	✓								
Check chain sharpness	✓								
Check guide bar condition	✓								
Check guide bar lube	✓								
Clean unit & labels		✓							
Clean air filter			✓						
Clean/inspect spark arrestor screen & inspect muffler				✓					
Replace spark plug					✓				
Replace fuel filter					✓				

GENERAL RECOMMENDATIONS

The warranty on this unit does not cover items that have been subjected to operator abuse or negligence. To receive full value from the warranty, the operator must maintain unit as instructed in this manual.

Some adjustments will need to be made periodically to properly maintain your unit.

All adjustments in the "Service and Adjustments" section of this manual should be checked at least once each season.

- Once a year, replace the spark plug, replace air filter element and check guide bar and chain for wear. A new spark plug and a clean/new air filter element assures proper air-fuel mixture and helps your engine run better and last longer.
- Follow the maintenance schedule in this manual.



WARNING:
DISCONNECT THE SPARK PLUG BEFORE PERFORMING MAINTENANCE EXCEPT FOR CARBURETOR ADJUSTMENTS.

INSPECT THE ENTIRE UNIT. REPLACE DAMAGED PARTS. CHECK FOR FUEL LEAKS AND MAKE SURE ALL FASTENERS ARE IN PLACE AND SECURELY FASTENED.

LUBRICATION CHART

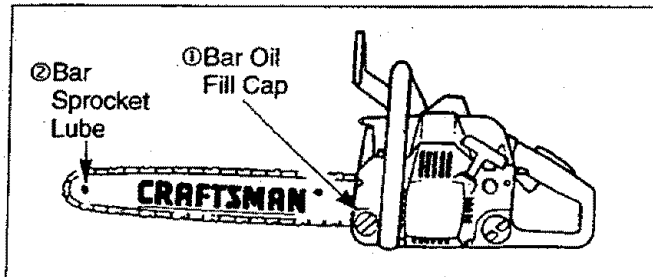

- ① Craftsman chain saw bar oil
- ② Craftsman bar sprocket lube

BEFORE USE

CHECK FOR DAMAGED OR WORN PARTS

The following damaged/worn parts should be referred to your Sears Service Center.

NOTE: It is normal for a small amount of oil to appear under the saw after engine stops. Do not confuse this with a leaking oil tank.

- On/Stop Switch – ensure on/stop switch functions properly by moving the switch to the "Stop" position and assure that engine stops, then restart your engine and continue.
- Fuel Tank – discontinue use of chain saw if fuel tank show signs of damage or leaks.
- Oil Tank – discontinue use of chain saw if oil tank shows signs of damage or leaks.
- Chain Catcher – replace chain catcher if bent, cut, or damaged in any way.

CHECK FOR LOOSE FASTENERS AND PARTS

- Bar Clamp Nut
- Chain
- Muffler
- Cylinder Shield
- Air Filter
- Clutch Drum/Sprocket
- Handle Screws
- Vibration Mounts
- Starter Housing
- Handguard

CHAIN TENSION (Fig. 19 & 20)

- Use the screwdriver end of the bar tool to move chain around the guide bar.
- If chain does not rotate, it is too tight – slightly loosen bar clamp nuts and turn adjusting screw 1/4 turn counter-clockwise. Retighten bar clamp nuts.
- If chain is too loose, it will sag below the guide bar. Figure 19.

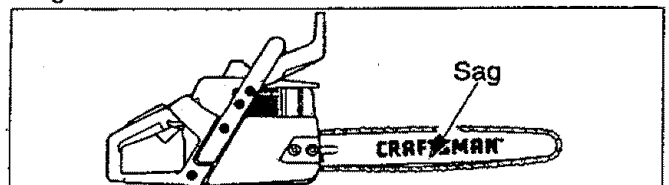

Figure 19

CUSTOMER RESPONSIBILITIES

- If chain is too loose, refer to "Chain Adjustment." Loosen bar clamp nuts; then, turn adjusting screw 1/4 turn clockwise. Lift up tip of guide bar to check for sag. Retighten bar clamp nuts. Figure 20.

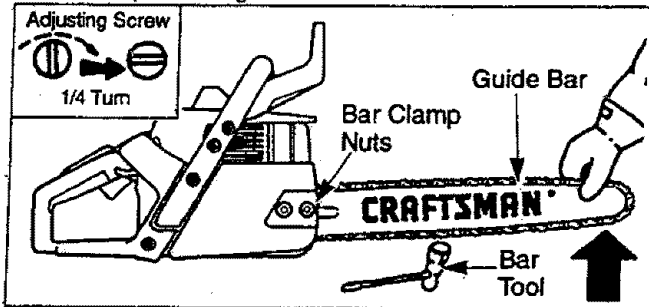

Figure 20

SHARPENING CHAIN (Fig. 21, 22, 23, 24, 25, 26 & 27)



WARNING:
IMPROPER CHAIN SHARPENING TECHNIQUES AND/OR DEPTH GAUGE MAINTENANCE WILL INCREASE THE CHANCE OF KICKBACK, WHICH CAN RESULT IN SERIOUS INJURY.

ALWAYS WEAR GLOVES WHEN HANDLING THE CHAIN. THE CHAIN CAN BE SHARP ENOUGH TO CUT YOU EVEN THOUGH IT IS TOO DULL TO CUT WOOD.

CHAIN TERMINOLOGY & PART NAMES

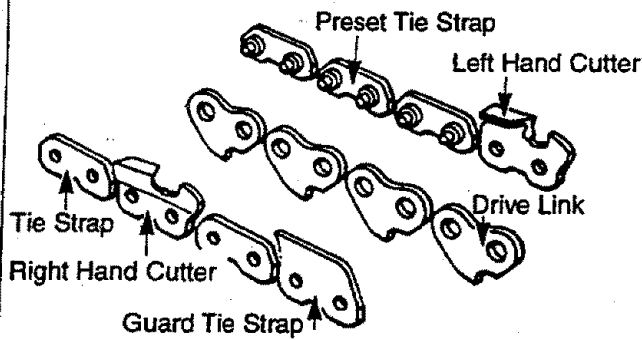

CHAIN CUTTER PART NAMES

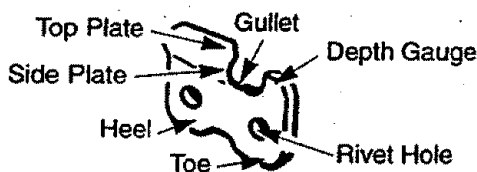

CHAIN "PITCH"

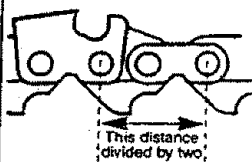

Pitch refers to chain measurement. A chain's pitch is the distance between any three of its rivets divided by two.

CHAIN "GAUGE"

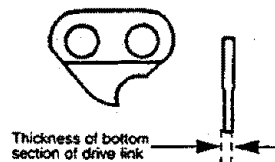

Gauge refers to thickness of that portion of drive link which fits into saw bar groove.

Tools required:

- Flat file
- .025 depth gauge
- 4.5mm round file & file holder

Conditions which indicate the need for chain sharpening:

- Reduction in size of wood chips. The size of the wood chip will decrease as the chain gets duller until it becomes more like a powder than a chip. Note that dead or rotted wood will not produce a good chip.
- Saw cuts to one side or at an angle.
- Saw requires excessive force to cut.
- Noticeable loss of cutting speed.

Sharpening instructions:

- Move on/stop switch to the "Stop" position.
- Check chain for proper tension. Adjust chain tension if necessary. (See Chain Tension/Adjustment).
- Check and lower depth gauges before sharpening cutters.
- Depth gauges should be checked every third sharpening. When cutting frozen wood the depth gauges should be checked each time you sharpen the chain.
- To check depth gauge, place gauge tool on cutter. If the depth gauge projects above the tool, then file it level to the top of the depth gauge tool. See Figure 21.

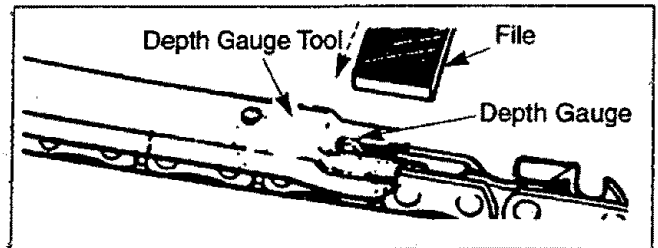

Figure 21

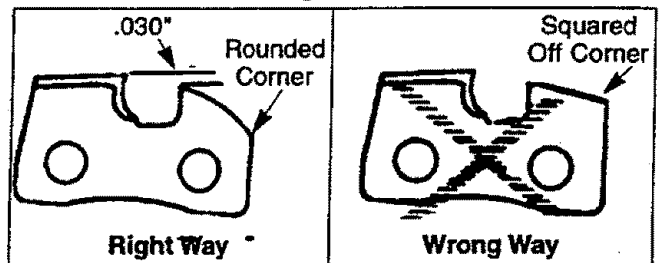

Figure 22

- To sharpen the cutters, position the file holder level (90°) so that it rests on the top edges of the cutter and depth gauge. See Figure 23.

NOTE: The chain has both left and right hand cutters.

- Sharpen cutters on one side of the chain first. File from the inside of each cutter to the outside. Then turn your saw around and repeat the process for the other side of the chain. See Figure 24.
- File on the forward stroke only. Use 2 or 3 strokes per cutting edge.
- Keep the 30° line on the file holder parallel to the center of the chain. Reverse procedure for other side. See Figure 25.
- Keep all cutters the same length when filing. See Figure 26.
- File enough to remove any damage to cutting edges (side plate and top plate) of cutter. See Figure 26.
- File chain to meet the specifications shown below. See Figure 27.

CUSTOMER RESPONSIBILITIES

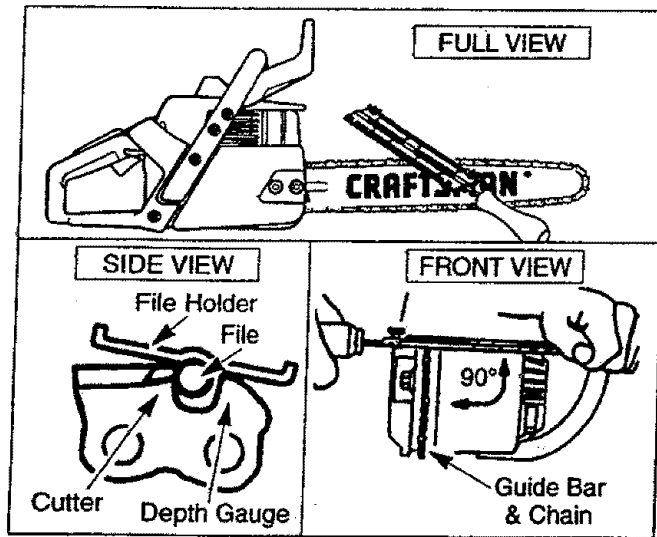

Figure 23

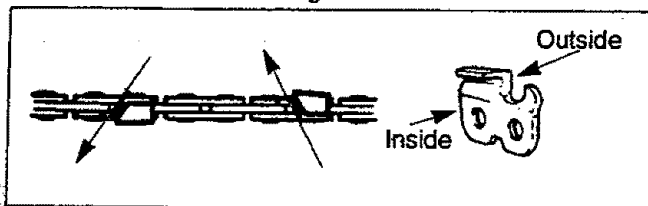

Figure 24

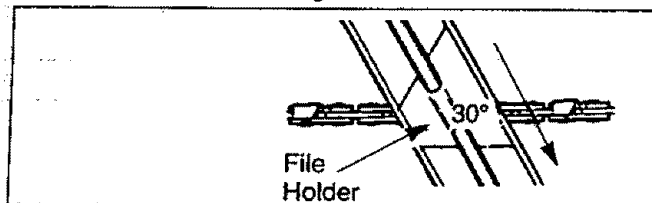

Figure 25

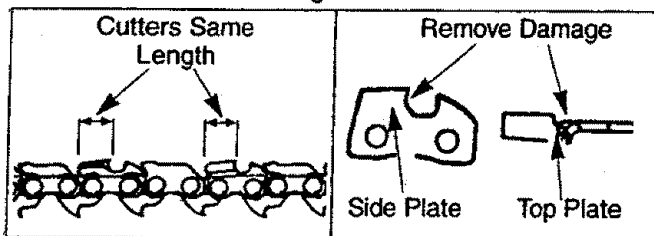

Figure 26

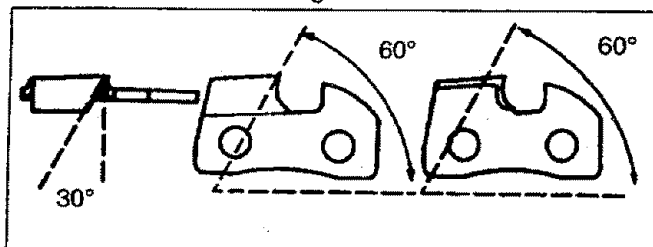

Figure 27

GUIDE BAR MAINTENANCE (Fig. 28 & 29)

Conditions which require guide bar maintenance:

- saw cuts to one side or at an angle.
- saw has to be forced through the cut.
- inadequate supply of oil to the bar and chain.

Check the condition of the guide bar each time the chain is sharpened. A worn guide bar will damage the chain and make cutting difficult.

- Move on/stop switch to the "Stop" position.
- Remove bar and chain from saw.
- Clean all saw dust and any other debris from the guide bar groove and guide bar lubrication hole. Figure 28.
- Lubricate guide bar hole sprocket after each use. Figure 28.
- Burring of bar rails is a normal process of guide bar rail wear. Remove these burrs by filing guide bar rail side edges square with a flat file. Figure 29.
- Restore square edges to an uneven rail top by filing with a flat file. Figure 29.



Figure 28

Replace the guide bar when:

- the inside groove of the guide bar rails is worn.
- the guide bar is bent or cracked.
- excess heating or burring of the rails is noted.

If replacement is necessary, use only the replacement reduced kickback guide bar specified for your saw in the repair parts list or as specified on the replacement bar and chain decal located on the chain saw.

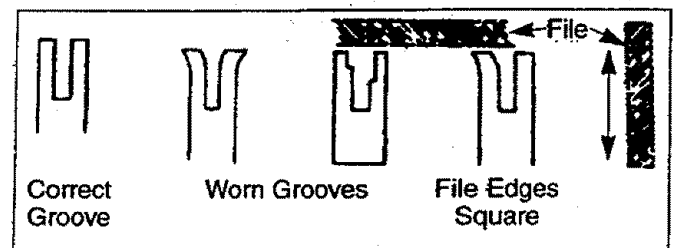

Figure 29

CUSTOMER RESPONSIBILITIES

AFTER USE

CLEAN UNIT AND LABELS

- Clean the unit using a damp cloth with a mild detergent.
- Wipe off the unit with a clean dry cloth.

EVERY 5 HOURS

CLEAN AIR FILTER (Fig. 30)

A dirty air filter decreases the life and performance of the engine and increases fuel consumption and harmful emissions.

Always clean your air filter after 15 tanks of fuel or 5 hours of operation, whichever is less. Clean more frequently in dusty conditions. A used air filter can never be completely cleaned. It is advisable to replace your air filter with a new one after every 50 hours of operation, or annually, whichever is less.

- Loosen 3 screws on cylinder cover.
- Remove cylinder cover.
- Remove air filter.
- Clean the air filter using hot soapy water. Rinse with clean cool water and air dry completely prior to re-installing.
- Lightly oil air filter prior to installing. Use 2-cycle engine oil or motor oil (SAE 30). Squeeze excess oil from filter. This will improve the efficiency of the air filter.
- Reinstall air filter.
- Reinstall cylinder cover and 3 screws (15-20 in-lbs.).

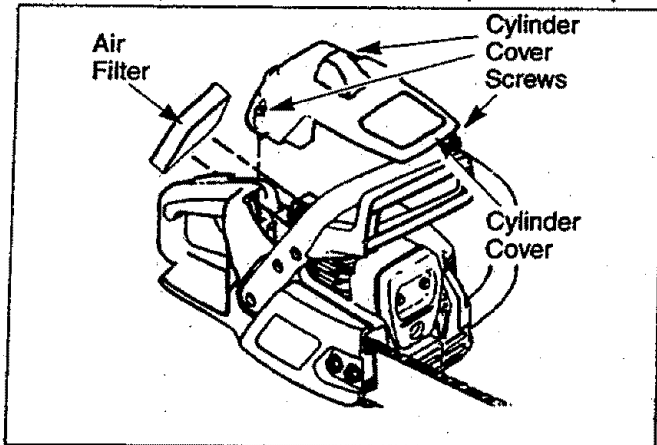

Figure 30

EVERY 25 HOURS INSPECT MUFFLER AND SPARK ARRESTOR SCREEN (IF INSTALLED) (Fig. 31)

As the unit is used, carbon deposits build up on the muffler and spark arrestor screen (if installed), and must be removed to avoid creating a fire hazard or affecting engine performance.

Required cleaning is every 25 hours of operation or annually, whichever is less.

Replace the spark arrestor screen if breaks occur.

CLEANING THE SPARK ARRESTOR SCREEN

- Loosen and remove the 2 muffler cover screws.
- Remove the muffler cover (cover snaps into muffler body).
- Remove muffler diffuser and spark arrestor screen assembly. Notice the orientation of these parts for reassembly.
- Clean the spark arrestor screen with a wire brush or replace if breaks are found in the screen.
- Replace any broken or cracked parts.
- Reinstall diffuser and spark arrestor screen assembly with round holes facing up and towards muffler cover.
- Reinstall muffler cover and 2 screws (7-8 ft-lbs).

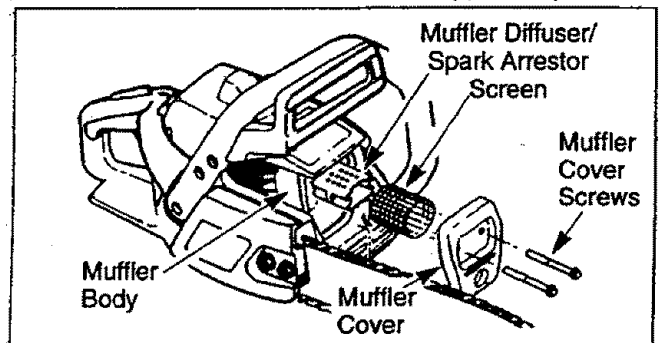

Figure 31

YEARLY REPLACE SPARK PLUG (Fig. 32)

The spark plug should be replaced each year to ensure the engine starts easier and runs better. Spark plug gap should be .025".

- Loosen 3 screws on cylinder cover.
- Remove cylinder cover.
- Twist, then pull off the spark plug boot.
- Remove spark plug from cylinder and discard.
- Replace with correct spark plug and tighten with a 3/4" socket wrench (10-12 lb-ft).
- Reinstall spark plug boot.
- Reinstall cylinder cover and 3 screws (15-20 in-lb).

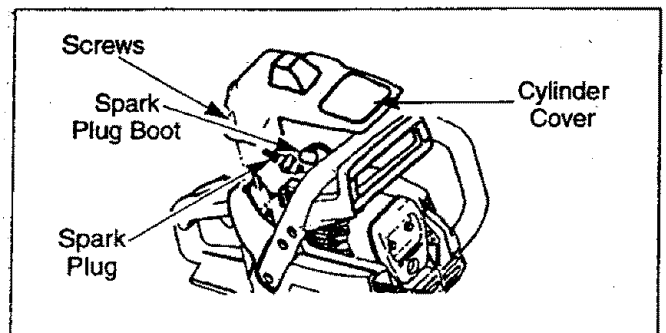

Figure 32

CUSTOMER RESPONSIBILITIES

REPLACE FUEL FILTER (Fig. 33, 34 & 35)

The fuel filter should be replaced after each season. Never operate your saw without a fuel filter. Be careful not to damage fuel line while removing the fuel filter.

- Run fuel tank dry of fuel before proceeding with this step.
- Remove fuel cap and allow it to hang to side of motor.
- Using a small pair of needle nose pliers, grasp fuel cap retainer, holding it in tank opening and pull out.
- With cap out of tank, use a small section of bent wire similar to that shown in the illustration to catch fuel line and slowly pull from tank. When fuel filter appears in opening, grasp with fingers and remove from tank.
- Once filter is out of tank, hold fuel line close to fuel filter. Remove fuel filter by twisting and pulling at the same time.
- Replace fuel filter.
- Reverse process for installation.

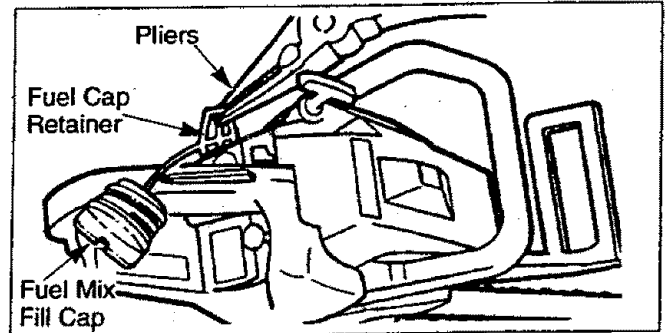

Figure 33

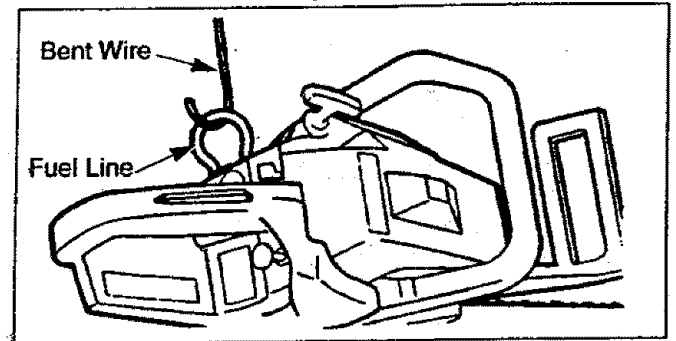

Figure 34

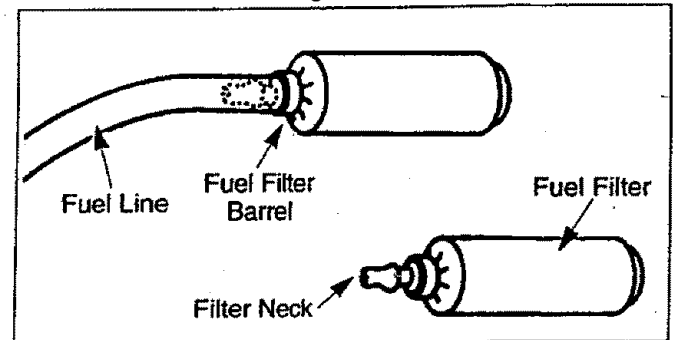

Figure 35

SERVICE AND ADJUSTMENTS

CHAIN REPLACEMENT (Fig. 36, 37, 38 & 39)



CAUTION: Wear protective gloves when handling chain. The chain is sharp and can cut you even when it is not moving.

It is normal for a new chain to stretch. Because of this initial stretch during the first 15-30 minutes of operation you should recheck your chain tension frequently and adjust the chain tension as required. See chain tension section.

- Move on/stop switch to the "Stop" position.
- Replace the old chain when it becomes worn or damaged.
- Use only the Low-Kickback replacement chain specified in the repair parts list or as specified on the replacement bar and chain decal located on the chain saw.
- See your Sears Service Center to replace and sharpen individual cutters for matching your chain.
- Loosen and remove the 2 bar clamp nuts.
- Remove bar clamp.
- Remove the old chain.
- Turn adjusting screw *by hand* counterclockwise until adjusting pin just touches the stop.
- Slide guide bar behind clutch drum until guide bar stops against clutch drum sprocket.
- Carefully remove new chain from package. Hold chain with the drive links as shown in Figure 37.
- Place chain over and behind the clutch.
- Fit bottom of drive links between teeth in sprocket nose.
- Fit chain drive links into top of guide bar. Figure 38.
- Pull guide bar forward until chain is snug in guide bar grooves.
- Now, install bar clamp making sure the adjusting pin is positioned in the lower hole in the guide bar.

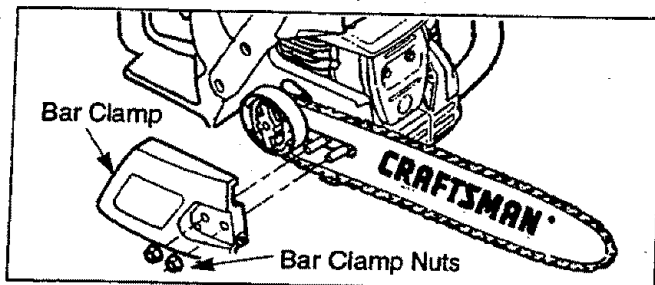

Figure 36

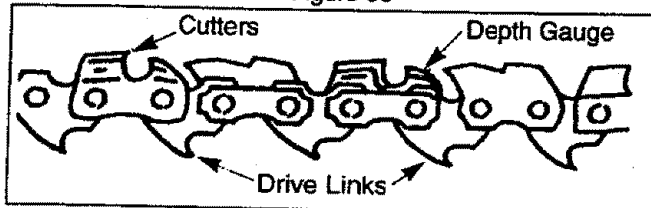

Figure 37

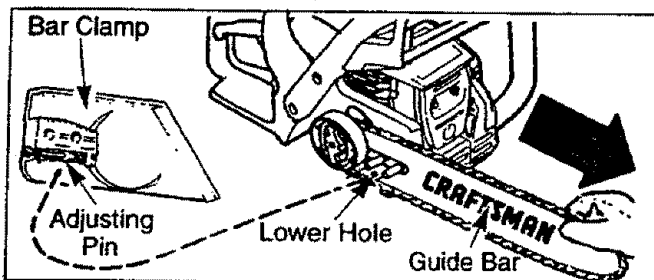

Figure 38

- Install bar clamp nuts and finger tighten only. *Do not* tighten any further at this point.
- Now proceed to the "Chain Adjustment" section.

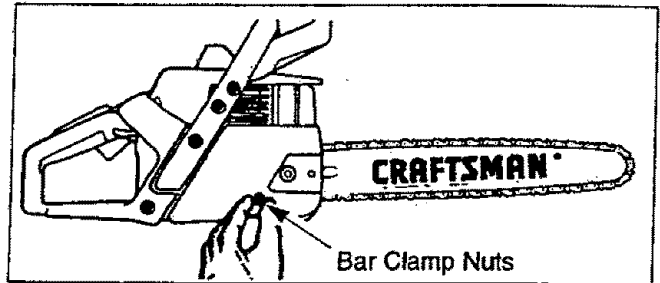

Figure 39

CHAIN ADJUSTMENT (Fig. 40, 41, 42 & 43)

- Roll chain around guide bar to ensure kinks do not exist (rotates freely).
- Assure bar clamp nuts are loosened (finger tight).
- Turn adjusting screw clockwise until chain just barely touches the bottom of guide bar.
- Roll chain around guide bar to ensure all links are in bar groove.

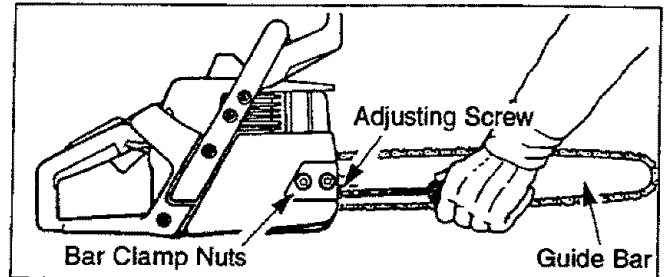

Figure 40

- Lift up tip of guide bar to check for sag, release tip of guide bar, then turn adjusting screw 1/4 turn clockwise. Repeat this step until a sag does not exist.
- While lifting tip of guide bar, tighten bar clamp nuts with the bar tool (provided). Torque 10-15 ft-lbs.

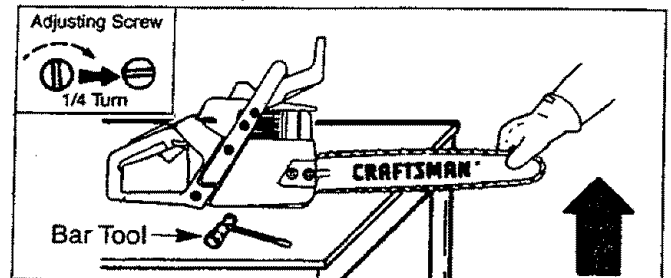

Figure 41

To check chain tension

- Use the screwdriver end of the bar tool to move chain around the guide bar (Figure 43).
- If chain does not rotate, it is too tight – slightly loosen bar clamp nuts and turn adjusting screw 1/4 turn counterclockwise. Retighten bar clamp nuts.
- If chain is too loose, it will sag below the guide bar (Figure 42).

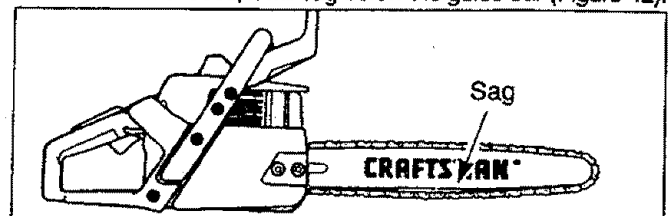

Figure 42

SERVICE AND ADJUSTMENTS

- If chain is too loose, refer to "Chain Adjustment." Loosen bar clamp nuts; then, turn adjusting screw 1/4 turn clockwise. Lift up tip of guide bar to check for sag. Retighten bar clamp nuts.

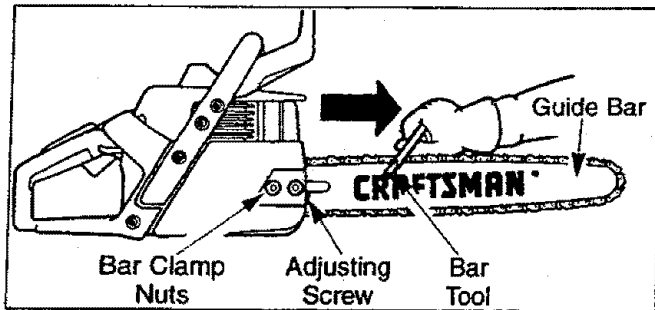

Figure 43

STARTER ROPE REPLACEMENT (Fig. 44, 45, 46, 47 & 48)



WARNING:
ALWAYS WEAR EYE PROTECTION WHEN SERVICING THE STARTER ROPE. THE RECOIL SPRING BENEATH THE PULLEY IS UNDER TENSION. IF THE SPRING POPS OUT, SERIOUS INJURY CAN RESULT.

Replace a broken starter rope or one that is badly frayed.

NOTE: A recoil spring lies beneath the pulley and is under tension. If the recoil spring is disturbed, considerable time and effort will be required to reinstall. For this reason you may want to let your Sears Service Center handle this repair. If you try to repair the starter rope and the recoil spring pops out, take the unit to your Sears Service Center.

- Remove the four fan housing screws and loosen the two screws on the cylinder cover.
- Remove fan housing from the unit.

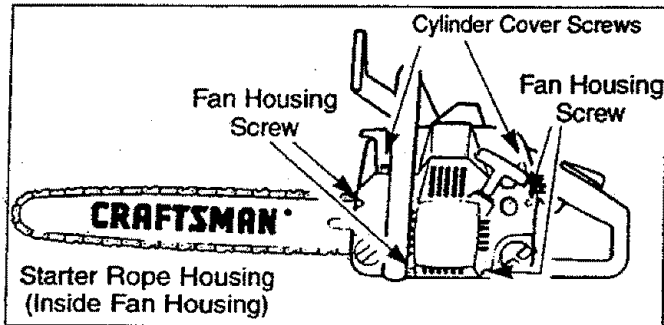

Figure 44

- To take out rope tension, pull out 10" of rope. While holding down pulley ratchet with thumb, push several inches of rope back into fan housing and catch in notch. Either hold pulley ratchet with thumb or hold starter rope handle. Retain rope in the notch and slowly allow pulley to turn counterclockwise until tension is gone.
- Remove the pulley screw in the center of the pulley.
- Gently twist and lift pulley while rotating counterclockwise.

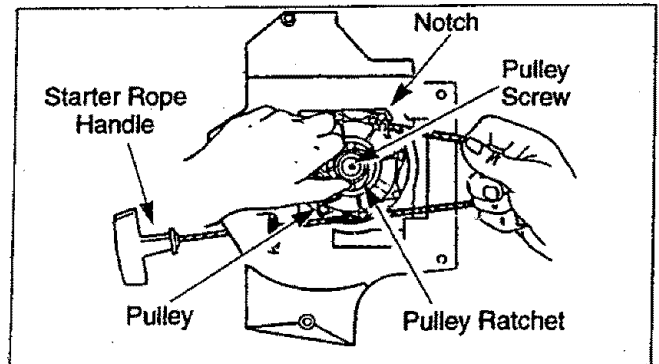

Figure 45

- Remove the rope retainer screw and remove any remaining rope.
- Move away from the fuel tank and melt the end of the new rope to be installed. Allow the melted end to drop once. Then, while the rope is still hot, pull the melted end through a rag to obtain a smooth pointed end.
- Feed rope through starter rope hole in starter housing.
- Guide the rope inside the pulley, then up through the pulley hole. It may be necessary to push the rope through with a small Phillips screwdriver inserted into the small hole on the underside of the pulley.
- Wrap rope counterclockwise around the pulley ratchet and tuck loose end back under rope, leaving a 1" tail between the retainer rib and screw post.
- Pull rope to tighten.
- Install the rope retainer screw and tighten until snug. Do not over-tighten.
- Rewind all the rope onto the pulley in a clockwise direction.

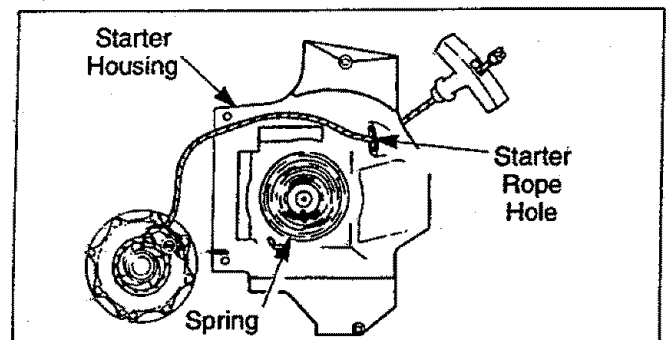

Figure 46

- Twist and push pulley into starter housing.
- Replace and tighten the pulley screw.

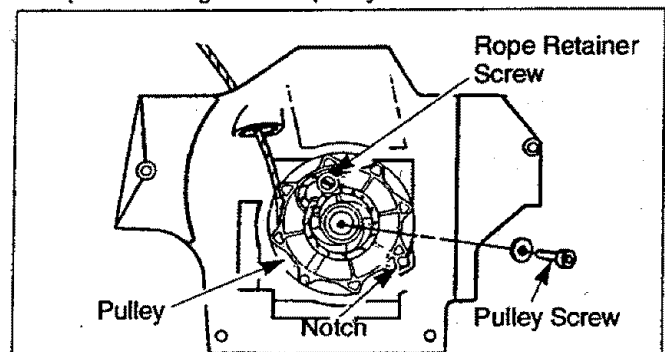

Figure 47

SERVICE AND ADJUSTMENTS

- Pull out 10" of rope and catch rope in notch in the pulley.
- Carefully turn the pulley two complete turns clockwise, keeping the rope against the notch to wind the spring.
- While holding the pulley ratchet, pull the excess rope through the starter rope hole. While holding tension on the rope, let rope slowly rewind into the housing.

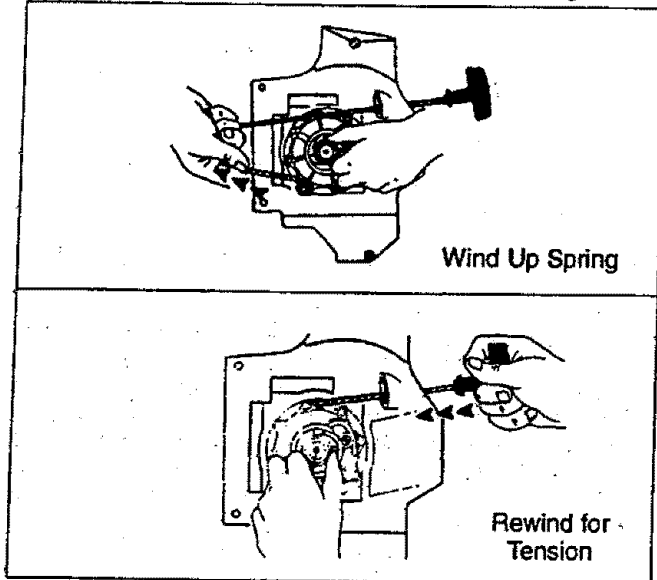

Figure 48

- Reinstall fan housing by aligning the fan housing to the chassis. Then while holding the fan housing against the chassis, pull the rope handle out until you feel the fan housing drop into place against the chassis. Slowly, let the rope rewind into starter housing.
- Reinstall the 4 fan housing screws and tighten the 2 cylinder cover screws. Figure 44.

SERVICE AND ADJUSTMENTS

CARBURETOR ADJUSTMENTS

Carburetor adjustment is critical and if done improperly can permanently damage the engine as well as the carburetor. Please read all instructions and consult the Trouble Shooting section of this manual before beginning this process. If the engine does not operate according to these instructions after repeating the adjusting steps, do not use the unit. For further assistance, please call our customer assistance hotline at 1-800-235-5878.



WARNING:
THE CHAIN WILL BE MOVING DURING MOST OF THIS PROCEDURE. WEAR YOUR PROTECTIVE EQUIPMENT AND OBSERVE ALL SAFETY PRECAUTIONS.

IN "LOW SPEED MIXTURE ADJUSTMENT," RECHECK IDLE SPEED AFTER EACH ADJUSTMENT. THE CHAIN MUST NOT MOVE AT IDLE SPEED.

If engine does not start, it may be flooded. If in doubt, read the section on flooded engine in the starting section of this manual prior to beginning any adjustments.

The carburetor has been adjusted at the factory for sea level conditions. Adjustments may become necessary if the saw is used at significantly higher altitudes or if you notice any of the following conditions:

- Chain moves when the engine runs at idle speed. See "Idle Speed Adjustment."
- Saw will not idle. See "Idle Speed Adjustment" and "Low Speed Mixture Adjustment."
- Engine dies or hesitates when it should accelerate. See "Acceleration Adjustment."
- Loss of cutting power which is not corrected by air filter cleaning. See "High Speed Mixture Adjustment."

NOTE – There are three adjustments on the carburetor.

- The Idle Speed Adjustment is marked with the letter "T."
- The two remaining adjustments on the carburetor are the mixture adjustments. One is marked "L" for low speed, and the other "H" for high speed.

CARBURETOR PRESETS (Fig. 49)

If your engine will not start due to suspected improper carburetor adjustment, the following presets may be required. If used, it is recommended that all steps within the adjustment procedure be completed in order to assure a properly set carburetor. If presets are not needed, proceed to section "Idle Speed Adjustment."

When making adjustments, be careful not to force the plastic limiter caps beyond the stops or damage will occur.

Very small adjustments can affect engine performance. It is important to make slight adjustments and test performance before proceeding. Each adjustment should be no more than 1/16 of a turn.

- Turn both of the mixture adjustments clockwise until they stop. Do not overtighten as damage to the needles will occur.
- Turn both mixture adjustments counterclockwise one full turn.
- Turn the idle speed adjustment clockwise until it stops. Now turn counterclockwise 4-1/2 turns.
- If engine fails to start after performing carburetor presets, the unit may be flooded. Review the "Difficult Starting" section of the manual. If problems continue, call the 1-800 number listed on the front cover of this manual for further assistance.
- Start the engine and operate for three (3) minutes to warm up. Go to "Adjusting Procedure."

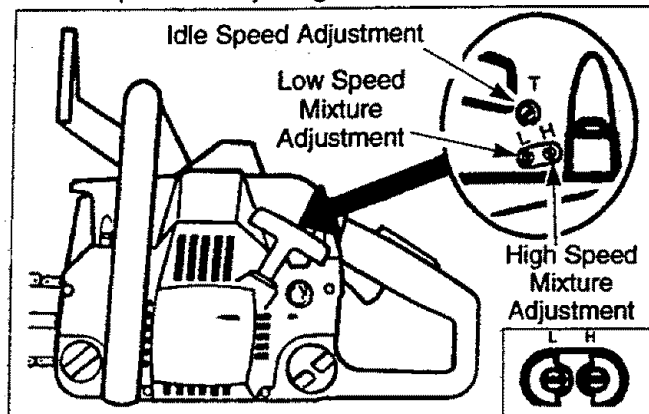

Figure 49

SERVICE AND ADJUSTMENTS

ADJUSTING PROCEDURE

IDLE SPEED ADJUSTMENT "I"

- Allow the warm engine to idle.
- Adjust the Idle Speed until the engine continues to run without stalling and without the chain moving.
 - Turn clockwise to increase engine speed if engine stalls or dies.
 - Turn counterclockwise to slow engine down and/or to keep the chain from turning.
- No further adjustments are necessary if chain does not move at idle speed and if performance is satisfactory.

LOW SPEED MIXTURE ADJUSTMENT "L"

- Allow engine to idle.
- Turn the Low Speed Mixture Adjustment slowly clockwise until the RPM starts to drop. Note the position.
- Turn the Low Speed Mixture Adjustment slowly counterclockwise until the RPM speeds up and starts to drop again. Note the position.
- Set the Low Speed Mixture at the midpoint between the two positions.

HIGH SPEED MIXTURE ADJUSTMENT "H"

IMPORTANT: DO NOT OPERATE ENGINE AT FULL THROTTLE FOR PROLONGED PERIODS WHILE MAKING HIGH SPEED ADJUSTMENTS AS DAMAGE TO THE ENGINE CAN OCCUR.

- Make a test cut.
- Based on performance of the saw while cutting, adjust the high speed mixture in 1/16 turn increments as follows:
 - Clockwise if saw loses power in the cut. Do not adjust for best power by sound or speed, but judge by how well the saw performs in the cut.
 - Counterclockwise if the saw has speed while out of the cut, but dies in the cut or lacks power while cutting.
- Repeat the test cut.
- Continue with 1/16 turn adjustments until the saw performance is acceptable while cutting.
- After completing adjustments, check for acceleration.

ACCELERATION CHECK

- If the engine dies or hesitates instead of accelerating, turn the Low Speed Mixture Adjustment 1/16 of a turn at a time counterclockwise until you have smooth acceleration.
- Check the idle speed for stability and no chain movement. Adjust as necessary.
- Recheck for smooth acceleration and stable idle. Repeat process as necessary for acceptable performance.

STORAGE

Immediately prepare your unit for storage at the end of the season or if it will not be used for 30 days or more.



WARNING:
ALLOW THE ENGINE TO COOL, AND SECURE THE UNIT BEFORE STORING OR TRANSPORTING IN A VEHICLE.

STORE UNIT AND FUEL IN AN AREA WHERE FUEL VAPORS CANNOT REACH SPARKS OR OPEN FLAMES FROM WATER HEATERS, ELECTRIC MOTORS OR SWITCHES, FURNACES, ETC.

STORE UNIT WITH ALL GUARDS IN PLACE. POSITION SO THAT ANY SHARP OBJECT CANNOT ACCIDENTALLY CAUSE INJURY TO PASSERS BY.

STORE THE UNIT OUT OF THE REACH OF CHILDREN.

GAS CHAIN SAW STORAGE INSTRUCTIONS

If your chain is to be stored for a period of time, clean it thoroughly prior to storage. Remove any dirt, sawdust, leaves, oil, grease, etc. Store in a clean dry area.

- Clean the entire unit.
- Clean air filter. Refer to "Customer Responsibilities."
- Inspect the bar clamp area and clean any dirt, sawdust, grass, or debris that has collected. Inspect the guide bar and chain; replace a guide bar that is bent, warped, cracked, broken, or damaged in any other way. Replace a damaged or worn chain.
- Lightly oil external metal surfaces to prevent rust from forming.



CAUTION: Wear protective gloves when handling chain. The chain is sharp and can cut you even when it is not moving.

- Apply a coating of oil to the entire surface of the guide bar and chain; wrap it in heavy paper or cloth.
- Be sure all handles and guards are in place and are securely fastened. Replace any damaged parts.

FUEL SYSTEM

Never use engine or carburetor cleaner products in the fuel tank or permanent damage may occur to fuel system components. Follow these instructions:

- Drain the fuel from the unit into an approved fuel container.
- Drain the fuel lines and carburetor by starting the engine and letting it run until it stops.
- Allow the engine to cool before storage.

IMPORTANT: It is important to prevent gum deposits from forming in essential fuel system parts such as the carburetor, fuel filter, fuel hose or tank during storage. Also, experience indicates that alcohol blended fuels, those that use ethanol or methanol (called gasohol or oxygenated fuel), can attract moisture and form acidic gas which will damage your engine. To avoid engine problems, the fuel system should be emptied before storage of 30 days or longer.

Fuel stabilizer is an acceptable alternative in minimizing the formation of fuel gum deposits during storage. Add stabilizer to the gasoline in the fuel tank or fuel storage container. Always follow the mix instructions found on stabilizer containers. Run engine at least 5 minutes after adding stabilizer to allow the stabilizer to reach the carburetor.

CRAFTSMAN 40:1 2-cycle engine oil (AIR-COOLED) is specially blended with fuel stabilizer. If you do not use this Sears oil, you can add a fuel stabilizer to your fuel tank.

INTERNAL ENGINE

- Remove spark plug and pour 1 teaspoon of 40:1 2-cycle engine oil (AIR-COOLED) through the spark plug opening. Slowly pull the starter rope 8 to 10 times to distribute oil to inner engine surfaces.
- Replace spark plug with a new one of the recommended type and heat range. Refer to "Product Specifications."
- Clean air filter. Refer to "Customer Responsibilities."
- Re-install all covers and hardware removed for access; tighten all screws and fasteners.
- Check entire unit for loose screws, nuts, and bolts. Replace any damaged, broken, or worn parts.
- Lightly oil external metal surface to prevent rust from forming.
- Use fresh fuel having the proper gasoline to oil ratio at the beginning of the next season.

OTHER

- Do not store gasoline from one season to another.
- Replace your gasoline can if your can starts to rust. Rust and/or dirt in your fuel system will cause problems.
- Store your unit in a well ventilated area and covered, if possible, to prevent dust and dirt accumulation. Do not cover with plastic. Plastic cannot breathe and will induce condensation and eventual rust or corrosion.

IMPORTANT: NEVER COVER UNIT WHILE ENGINE AND EXHAUST AREAS ARE STILL WARM.

TROUBLE SHOOTING POINTS

TROUBLE SHOOTING CHART

SYMPTOM	CAUSE	CORRECTION
Engine will not start or will only run only for a few seconds after starting.	<ol style="list-style-type: none"> 1. Fuel tank empty. 2. Engine flooded. 3. Spark plug not firing. 4. Fuel not reaching carburetor. 5. Carburetor requires adjustment. 6. On/Stop switch in "Stop" position. 7. None of the above. 	<ol style="list-style-type: none"> 1. Fill tank with correct fuel mixture. 2. See "Starting Instructions." 3. Install new plug/check ignition system. 4. Replace fuel filter; inspect fuel line. 5. See "Carburetor Adjustments." 6. Move switch to the "On" position. 7. Contact your Sears Service Center/Dept.
Engine will not idle properly.	<ol style="list-style-type: none"> 1. Idle speed set too fast or too slow. 2. Low speed mixture requires adjustment. 3. Crankshaft seals worn. 4. Compression low. 5. None of the above. 	<ol style="list-style-type: none"> 1. See "Carburetor Adjustments." 2. See "Carburetor Adjustments." 3. Contact your Sears Service Center/Dept. 4. Contact your Sears Service Center/Dept. 5. Contact your Sears Service Center/Dept.
Engine will not accelerate, lacks power, or dies under a load.	<ol style="list-style-type: none"> 1. Air filter dirty. 2. Spark plug fouled. 3. Carburetor requires adjustment. 4. Exhaust ports or muffler outlets plugged. 5. Compression low. 6. None of the above. 	<ol style="list-style-type: none"> 1. Clean or replace air filter. 2. Clean or replace spark plug and re-gap. 3. See "Carburetor Adjustments." 4. Contact your Sears Service Center/Dept. 5. Contact your Sears Service Center/Dept. 6. Contact your Sears Service Center/Dept.
Engine smokes excessively.	<ol style="list-style-type: none"> 1. Air filter dirty. 2. Fuel mixture incorrect. 3. High speed mixture requires adjustment. 4. Choke partially on. 5. Crankcase leak. 	<ol style="list-style-type: none"> 1. Clean or replace air filter. 2. Refuel with correct fuel mixture. 3. See "Carburetor Adjustments." 4. Push blue choke knob in. 5. Contact your Sears Service Center/Dept.
Engine runs hot.	<ol style="list-style-type: none"> 1. Fuel mixture incorrect. 2. High speed mixture set too lean. 3. Spark plug incorrect. 4. Exhaust ports or muffler outlets plugged. 5. Carbon build-up on muffler outlet screen. 6. Fan housing/cylinder fins dirty. 7. None of the above. 	<ol style="list-style-type: none"> 1. See "Fueling Your Unit." 2. See "Carburetor Adjustments." 3. Replace with correct plug. 4. Contact your Sears Service Center/Dept. 5. Clean spark arrestor screen. 6. Clean area. 7. Contact your Sears Service Center/Dept.
Oil inadequate for bar and chain lubrication.	<ol style="list-style-type: none"> 1. Oil tank empty. 2. Oil pump or oil filter clogged. 3. Guide bar oil hole blocked. 	<ol style="list-style-type: none"> 1. Fill oil tank. 2. Contact your Sears Service Center/Dept. 3. Remove bar and clean.
Chain moves at idle speed.	<ol style="list-style-type: none"> 1. Idle speed requires adjustment. 2. Clutch requires repair. 	<ol style="list-style-type: none"> 1. See "Carburetor Adjustments." 2. Contact your Sears Service Center/Dept.
Chain does not move when engine is accelerated.	<ol style="list-style-type: none"> 1. Chain tension too tight. 2. Carburetor requires adjustment. 3. Guide bar rails pinched. 4. Clutch slipping. 	<ol style="list-style-type: none"> 1. See "Chain Tension." 2. See "Carburetor Adjustments." 3. Repair or replace. 4. Contact your Sears Service Center/Dept.
Chain clatters or cuts roughly.	<ol style="list-style-type: none"> 1. Chain tension incorrect. 2. Cutters damaged 3. Chain worn. 4. Cutters dull, improperly sharpened, or depth gauges too high. 5. Sprocket worn. 6. Chain installed backwards. 	<ol style="list-style-type: none"> 1. See "Chain Tension." 2. Contact your Sears Service Center/Dept. 3. Resharpener or replace chain. 4. See "Sharpening Chain." 5. Contact your Sears Service Center/Dept. 6. Install chain in right direction.
Chain stops within the cut.	<ol style="list-style-type: none"> 1. Chain cutter tops not filed flat. 2. Guide bar burred or bent; rails uneven. 3. Clutch slipping. 	<ol style="list-style-type: none"> 1. See "Sharpening Chain." 2. Repair or replace guide bar. 3. Contact your Sears Service Center/Dept.
Chain cuts at an angle.	<ol style="list-style-type: none"> 1. Cutters damaged on one side. 2. Chain dull on one side. 3. Guide bar bent or worn. 	<ol style="list-style-type: none"> 1. See "Sharpening Chain." 2. See "Sharpening Chain." 3. Replace guide bar.

*If situations occur which are not covered in this manual, use care and good judgement.
If you need assistance, contact your SEARS Service Center/Department or the
CUSTOMER ASSISTANCE HOTLINE at 1-800-235-5878.*

REPAIR PARTS

SEARS CHAINSAW - MODELS 358.35108, 358.35116, 358.35118

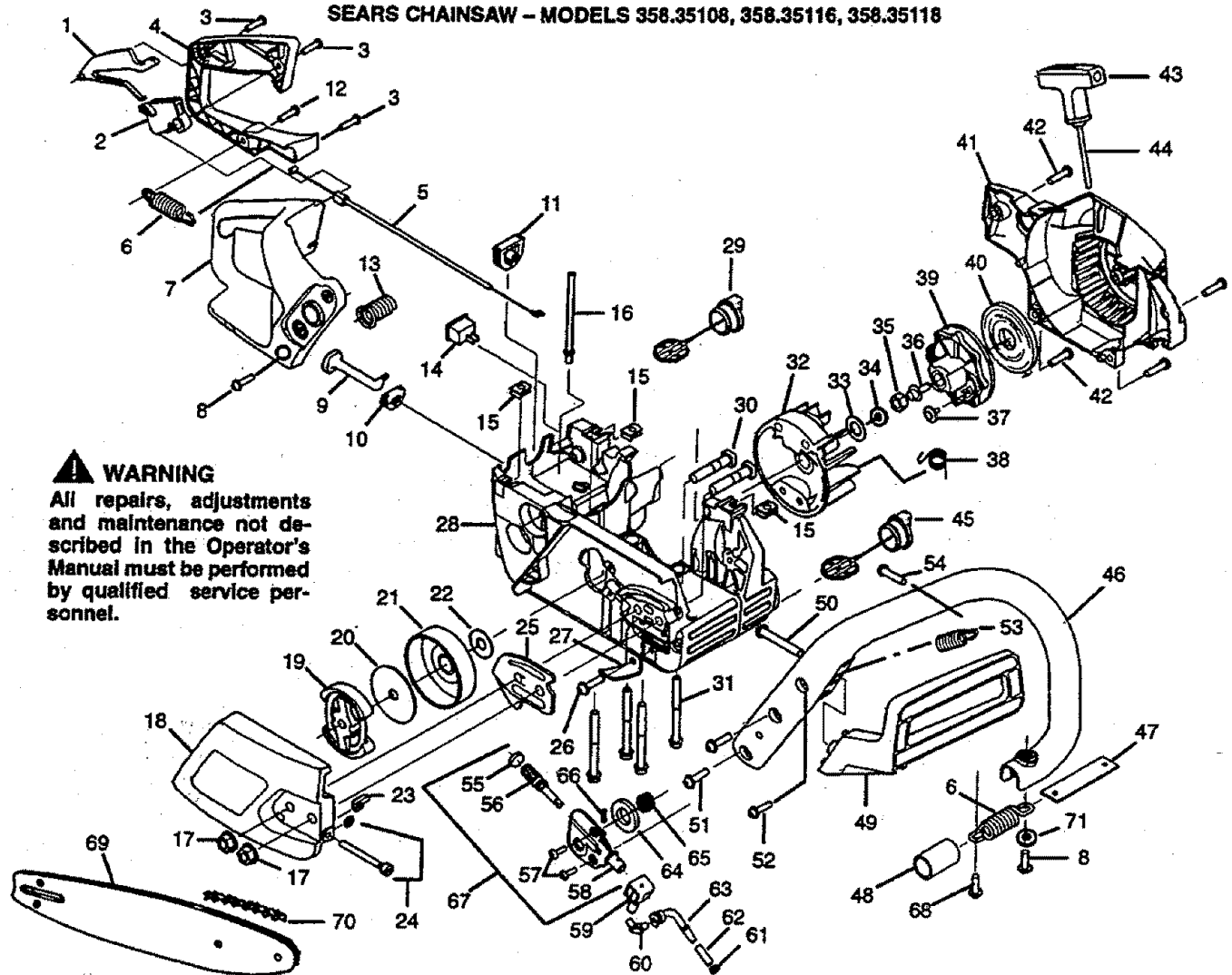

WARNING
All repairs, adjustments and maintenance not described in the Operator's Manual must be performed by qualified service personnel.

Ref.	Part No.	Description	Ref.	Part No.	Description	Ref.	Part No.	Description
1.	530-038988	Throttle Lockout	23.	530-016109	Pin-Bar Adjusting	48.	530-036142	Isolator Sleeve
2.	530-038987	Throttle Trigger	24.	530-069611	Bar Adjusting Kit	49.	530-038224	Handguard
3.	530-015906	Screw	25.	530-038238	w/Screw & Retainer	50.	530-016020	Screw
4.	530-047581	Cover-Rear Handle	26.	530-015905	Plate-Bar Mounting	51.	530-015843	Screw
5.	530-047602	Throttle Cable	27.	530-029850	Screw	52.	530-016009	Screw
6.	530-042082	Spring	28.	530-047600	Chain Catcher	53.	530-047934	Spring Ass'y.
7.	530-047582	Rear Handle	29.	530-047192	Chassis Ass'y.	54.	530-015875	Screw
8.	530-016018	Screw	30.	530-016133	Fuel Cap Ass'y.	55.	530-038543	Dust Plug
9.	530-047605	Choke Knob	31.	530-016132	Bolt-Bar	56.	530-038546	Gear Ass'y.
10.	530-049005	Grommet-Choke Knob	32.	530-039187	Screw	57.	530-016097	Screw
11.	530-047631	Grommet-Throttle	33.	530-400897	Cable	58.	530-037818	Oil Pump Body
12.	530-015886	Screw	34.	530-001717	Washer	59.	530-019206	Seal Block
13.	530-036962	Spring Ass'y.	35.	530-001717	Lockwasher	60.	530-038241	Fitting-Elbow
14.	530-037692	Spring Ass'y.	36.	530-015920	Nut	61.	530-030189	Plug-Oil Filter
15.	530-015922	Ignition Switch	37.	530-016080	Screw	62.	530-037821	Oil Filter
16.	530-069247	Nut-"U" Type	38.	530-023817	Screw	63.	530-038373	Pick-up Tube
17.	530-015917	Fuel Line Kit	39.	530-023817	Spring-Starter Dog	64.	530-019231	Dust Seal
18.	530-037803	(Large Dia.)	40.	530-037817	Starter Pulley	65.	530-037820	Worm Gear
19.	530-014949	Nut-Bar Mounting	41.	530-027531	Recoil Spring	66.	530-016138	Pin
20.	530-015611	Clutch Cover	42.	530-047974	Fan Housing	67.	530-069698	Oil Pump Kit
21.	530-047061	Clutch Ass'y.	43.	530-015892	Screw	68.	530-015843	Screw
22.	530-015907	Clutch Washer	44.	530-037485	Starter Handle	69.	71-36366	Bar-16"
		Clutch Drum Ass'y.	45.	530-069232	Rope Kit	70.	71-36374	Bar-18"
		w/Bearing	46.	530-010846	Oil Cap Ass'y.	71.	71-3629	Chain-16"
		Washer	47.	530-047583	Front Handle		71-3619	Chain-18"
				530-047608	Limiter Strap		530-015158	Washer-Flat

REPAIR PARTS

SEARS CHAINSAW—MODELS 358.35108, 358.35116, 358.35118

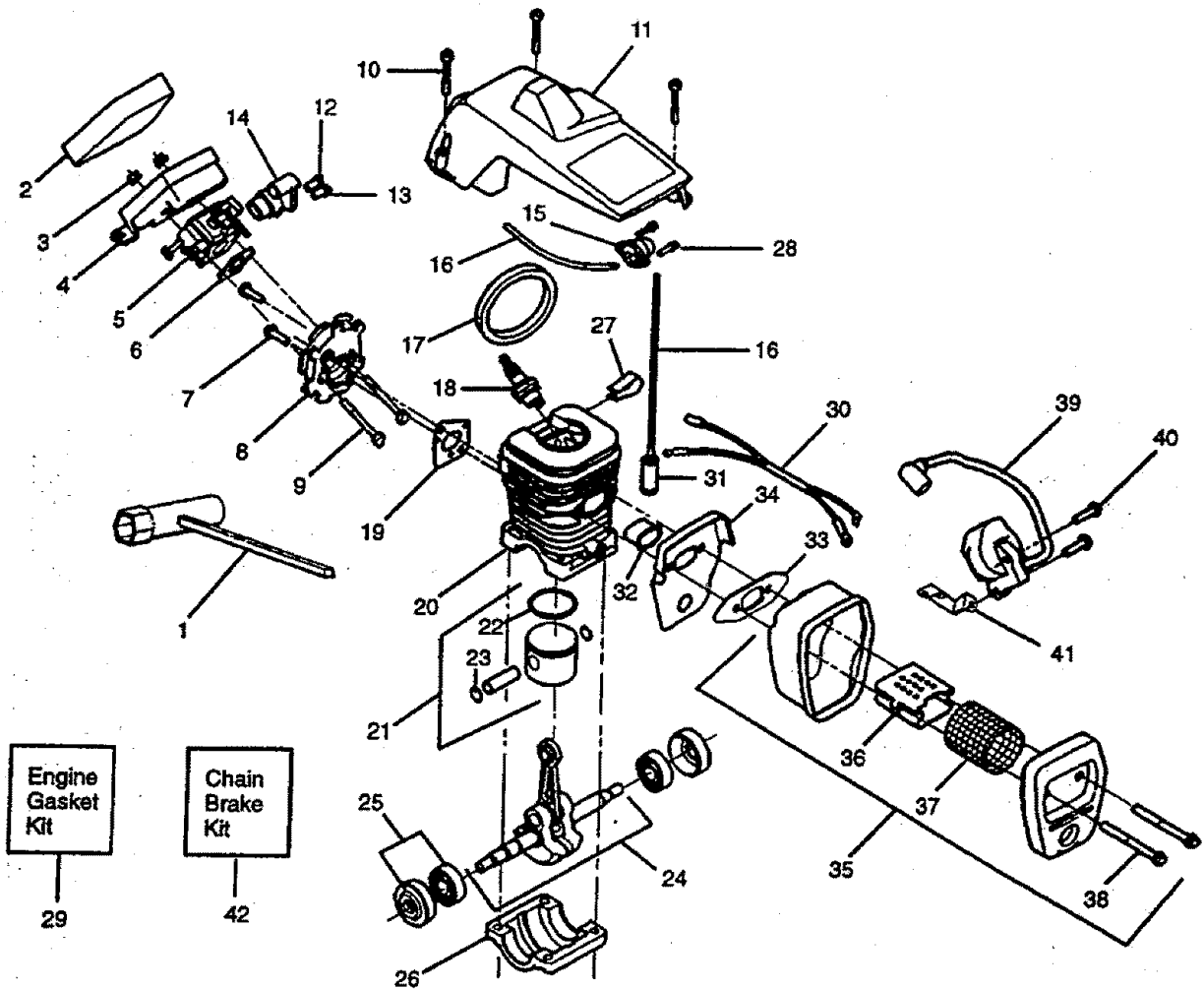

Ref.	Part No.	Description	Ref.	Part No.	Description	Ref.	Part No.	Description
1.	530-031163	Bar Wrench	22.	530-038729	Piston Ring	Not Shown		
2.	530-037793	Foam-Air Filter	23.	530-015697	Retainer			
3.	530-016101	Nut	24.	530-047062	Crankshaft Ass'y.			
4.	530-047604	Air Filter Housing	25.	530-047179	Seal & Bearing Ass'y.			
5.	530-069722	Carburetor Ass'y. Kit (Incl. 12 & 13)	26.	530-037935	Cap-Crankcase			
6.	530-019217	Carb. Gasket	27.	530-016136	Clip			
7.	530-015810	Screw	28.	530-016090	Screw			
8.	530-047824	Carb. Adapter Kit (Incl. 9 & 17)	29.	530-069608	Engine Gasket Kit (Incl. 6, 17, 19 & 33)			
9.	530-016094	Screw	30.	530-047603	Wire Harness Ass'y.			
10.	530-016153	Screw	31.	530-014362	Fuel Filter			
11.	530-047578	Cylinder Shield	32.	530-037652	Heat Insulator			
12.	530-038318	Limiter Cap-High	33.	530-019221	Muffler Gasket			
13.	530-038317	Limiter Cap-Low	34.	530-038237	Muffler Back Plate			
14.	530-038340	Grommet	35.	530-047207	Muffler Ass'y. (Incl. 33-34 & 36-38)			
15.	530-047566	Primer Ass'y.	36.	530-037245	Muffler Diffuser			
16.	530-069216	Primer Line Kit (Small Dia)	37.	530-036103	Spark Arrestor Screen			
17.	530-019210	Air Box Seal	38.	530-016132	Screw			
18.	71-85849	Spark Plug (CJ-7Y)	39.	530-039167	Ignition Module			
19.	530-019208	Gasket	40.	530-015905	Screw			
20.	530-069607	Cylinder Kit	41.	530-047442	Ground Strap			
21.	530-069605	Piston Kit (Incl. 22 & 23)	42.	952-706606	Chain Brake Kit			

REPAIR PARTS

SEARS CHAINSAW – MODELS 358.35108, 358.35116, 358.35118

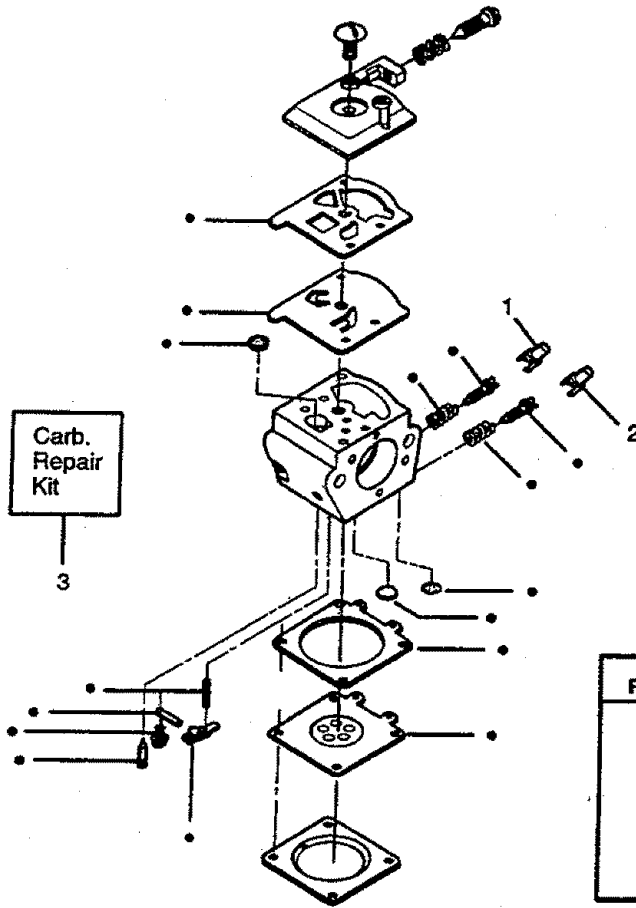

Ref.	Part No.	Description
1.	530-038318	Limiter Cap-High
2.	530-038317	Limiter Cap-Low
3.	530-035399	Carburetor Repair Kit (• Indicates Contents)

SEARS

Operator's Manual

Model No.
358.351080 - 18"
358.351160 - 16"
358.351180 - 18"

IF YOU NEED REPAIR SERVICE OR PARTS:

REPAIR SERVICE
1-800-4-REPAIR
(1-800-473-7247)

ORDERING PARTS
1-800-FON-PART
(1-800-366-7278)



**CUSTOMER
ASSISTANCE**
1-800-235-5878

HOURS (CST)
Mon. - Sat. 7 a.m. - 7 p.m.
Sun. 10 a.m. - 7 p.m.

CRAFTSMAN®

2.4 cu. in/40cc 2-CYCLE 2.4 cu. in/40cc 2-CYCLE 2.6 cu. in/42cc 2-CYCLE GASOLINE CHAIN SAW

Each Gasoline Chain Saw has its own model number. The model number for your unit will be found on a decal attached to the unit.

All parts listed herein may be ordered from any Sears, Roebuck and Co. Service Center and most Retail Stores.

WHEN ORDERING REPAIR PARTS, ALWAYS GIVE THE FOLLOWING INFORMATION:

- PRODUCT - "GASOLINE CHAIN SAW"
- MODEL NUMBER - 358.351080 - 18"
358.351160 - 16"
358.351180 - 18"
- PART NUMBER
- PART DESCRIPTION

Your Sears merchandise has added value when you consider that Sears has service units nationwide staffed with Sears trained technicians... professional technicians specifically trained on Sears products, having the parts, tools and equipment to insure that we meet our pledge to you, we service what we sell.

Sears, Roebuck and Co., Hoffman Estates, IL 60179 U.S.A.
