

# KORG DIGITAL PIANO CONCERT

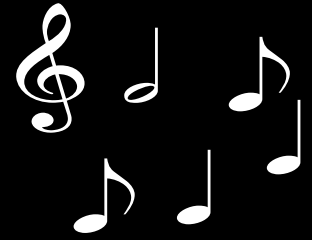

## C-4500

Thank you for purchasing the Korg Digital Piano Concert C-4500. To ensure long, trouble-free operation, please read this manual carefully.

## Owner's Manual

### Contents

<b>About Recorder data</b> .....	3
<b>Conventions in this manual</b> .....	3
<b>Main features</b> .....	4
<b>Parts of the C-4500 and their function</b> .....	4
<b>Switch functions</b> .....	6
<b>Preparations for playing</b> .....	7
<b>Listening to the demo songs</b> .....	9
Practicing along with a demo song .....	9
<b>Playing the C-4500</b> .....	11
1. Selecting a sound .....	11
2. Adding effects to the sound .....	11
3. Using the pedals .....	12
4. Playing with the metronome .....	13
5. Adjusting the keyboard touch .....	14
6. Changing keys (Transpose) .....	14
7. Adjusting the pitch .....	15
8. Selecting a temperament .....	15

<b>Recording / playing back your performance</b> .....	17
1. Recording your performance .....	17
2. Playing back your recorded performance .....	18
3. Erasing recorded data .....	18
<b>Connecting other devices</b> .....	19
1. Connecting a synthesizer or audio system .....	19
2. Connecting MIDI equipment .....	19
3. Connecting a computer .....	22
<b>Troubleshooting</b> .....	23
<b>Specifications</b> .....	24
<b>Assembling the ST-4500</b> .....	25



# INSTRUCTIONS PERTAINING TO A RISK OF FIRE, ELECTRIC SHOCK, OR INJURY TO PERSONS

## IMPORTANT SAFETY INSTRUCTIONS

**WARNING**—When using electric products, basic precautions should always be followed, including the following:

- 1) Read all the instructions before using the product.
- 2) Do not use this product near water—for example, near a bathtub, washbowl, kitchen sink, in a wet basement, or near a swimming pool, or the like.
- 3) This product should be used only with a cart or stand that is recommended by the manufacturer.
- 4) This product, either alone or in combination with an amplifier and headphones or speakers, may be capable of producing sound levels that could cause permanent hearing loss. Do not operate for a long period of time at a high volume level or at a level that is uncomfortable. If you experience any hearing loss or ringing in the ears, you should consult an audiologist.
- 5) The product should be located so that its location or position does not interfere with its proper ventilation.
- 6) The product should be located away from heat sources such as radiators, heat registers, or other products that produce heat.
- 7) The product should be connected to a power supply only of the type described in the operating instructions or as marked on the product.
- 8) This product may be equipped with a polarized line plug (one blade wider than the other). This is a safety feature. If you are unable to insert the plug into the outlet, contact an electrician to replace your obsolete outlet. Do not defeat the safety purpose of the plug. (for U.S.A. and Canada)
- 9) The power-supply cord of the product should be unplugged from the outlet when left unused for a long period of time.
- 10) Care should be taken so that objects do not fall and liquids are not spilled into the enclosure through openings.
- 11) The product should be serviced by qualified service personnel when:
  - a) The power-supply cord or the plug has been damaged; or
  - b) Objects have fallen, or liquid has been spilled onto the product; or
  - c) The product has been exposed to rain; or
  - d) The product does not appear to operate normally or exhibits a marked change in performance; or
  - e) The product has been dropped, or the enclosure damaged.
- 12) Do not attempt to service the product beyond that described in the user-maintenance instructions. All other servicing should be referred to qualified service personnel.

## SAVE THESE INSTRUCTIONS

### WARNING:

**TO REDUCE THE RISK OF FIRE OR ELECTRIC SHOCK DO NOT EXPOSE THIS PRODUCT TO RAIN OR MOISTURE.**

	<b>CAUTION</b> RISK OF ELECTRIC SHOCK DO NOT OPEN	
<b>AVERTISSEMENT:</b> RISQUE DE CHOC ÉLECTRIQUE—NE PAS OUVRIR.		
<b>注意</b> 感電の恐れあり、キャビネットをあけるな		
CAUTION: TO REDUCE THE RISK OF ELECTRIC SHOCK, DO NOT REMOVE COVER (OR BACK). NO USER-SERVICEABLE PARTS INSIDE. REFER SERVICING TO QUALIFIED SERVICE PERSONNEL.		



The lightning flash with arrowhead symbol, within an equilateral triangle, is intended to alert the user to the presence of uninsulated "dangerous voltage" within the product's enclosure that may be of sufficient magnitude to constitute a risk of electric shock to persons.



The exclamation point within an equilateral triangle is intended to alert the user to the presence of important operating and maintenance (servicing) instructions in the literature accompanying the product.

**CAUTION:** TO PREVENT ELECTRIC SHOCK, MATCH WIDE BLADE OF PLUG TO WIDE SLOT, FULLY INSERT. (for U.S.A. and Canada)

**ATTENTION:** POUR ÉVITER LES CHOC ÉLECTRIQUES, INTRODUIRE LA LAME LA PLUS LARGE DE LA FICHE DANS LA BORNE CORRESPONDANTE DE LA PRISE ET POUSSER JUSQU'AU FOND. (for Canada)

### THE FCC REGULATION WARNING (for U.S.A.)

This equipment has been tested and found to comply with the limits for a Class B digital device, pursuant to Part 15 of the FCC Rules. These limits are designed to provide reasonable protection against harmful interference in a residential installation. This equipment generates, uses, and can radiate radio frequency energy and, if not installed and used in accordance with the instructions, may cause harmful interference to radio communications. However, there is no guarantee that interference will not occur in a particular installation. If this equipment does cause harmful interference to radio or television reception, which can be determined by turning the equipment off and on, the user is encouraged to try to correct the interference by one or more of the following measures:

- Reorient or relocate the receiving antenna.
- Increase the separation between the equipment and receiver.
- Connect the equipment into an outlet on a circuit different from that to which the receiver is connected.
- Consult the dealer or an experienced radio/TV technician for help.

Unauthorized changes or modification to this system can void the user's authority to operate this equipment.

### CE mark for European Harmonized Standards

CE mark which is attached to our company's products of AC mains operated apparatus until December 31, 1996 means it conforms to EMC Directive (89/336/EEC) and CE mark Directive (93/68/EEC).

And, CE mark which is attached after January 1, 1997 means it conforms to EMC Directive (89/336/EEC), CE mark Directive (93/68/EEC) and Low Voltage Directive (73/23/EEC).

Also, CE mark which is attached to our company's products of Battery operated apparatus means it conforms to EMC Directive (89/336/EEC) and CE mark Directive (93/68/EEC).

### IMPORTANT NOTICE FOR THE UNITED KINGDOM

As the colours of the wires in the mains lead of this apparatus may not correspond with the coloured markings identifying the terminals in your plug, proceed as follows:

- the wire which is coloured blue must be connected to the terminal which is marked with the letter N or coloured black.
- the wire which is coloured brown must be connected to the terminal which is marked with the letter L or coloured red.
- Do not connect the wire to the earth terminal of a three-pin plug.

---

## About the backup battery

This product contains a backup battery that prevents the contents of internal memory from being lost when the power is turned off. If the [TOUCH] switch indicator blinks when the power is turned on, the battery must be replaced. Please contact a nearby Korg dealer or a Korg service center.

- When you press the [TOUCH] switch, it will stop blinking.

## About Recorder data

Since it is possible for the contents of memory to be accidentally lost, you should save important data on an external data filer (storage device) etc. (p.21).

Korg will accept no responsibility for any damages that may result from loss of data.

## Conventions in this manual

**Switches** Switches on this instrument are enclosed in [square brackets].



This symbol indicates a caution.

(p.\*\*)

This indicates a reference page.



This indicates an explanation concerning a setting.

## Main features

### A wide variety of sounds (p.11)

Six different expressive and high-quality sounds, including a concert grand piano, are produced by Korg's proprietary **HI (Hyper Integrated) synthesis system**. You can use the Layer or Split functions to play two sounds simultaneously.

### Effects (p.11)

The C-4500 provides built-in digital effects that can simulate the reverberation of a concert hall or add rich spaciousness.

### Pedal effects (p.12)

The C-4500 has the same three pedals as on an acoustic piano: damper, sostenuto, and soft. The damper pedal of the C-4500 also simulates the resonances that occur in the strings of an acoustic piano. The damper pedal and soft pedal allow half-pedaling techniques, where the amount of effect can be adjusted by the depth with which you press the pedal.

### Metronome function (p.13)

The built-in metronome allows you to adjust the time signature, tempo, and volume, and even use a bell sound as the accent.

### Recorder function (p.17)

The built-in recorder lets you record and play back your performance as easily as when using a tape recorder.

### Touch control function (p.14)

You can choose from three different settings to adjust how the sound will respond to your keyboard playing dynamics.

### Temperaments (p.15)

In addition to equal temperament, the C-4500 allows you to select two classical temperaments (Kirnberger and Werckmeister) for historically accurate performance of classical music.

### Adjustable pitch (p.15)

The Transpose function lets you change the pitch of the piano, and the Pitch Control function allows you to make fine adjustments in the tuning.

### MIDI capability (p.19)

The C-4500 supports MIDI, the standard that allows musical data to be transferred between musical instruments and computers. MIDI allows two or more devices to control or be controlled by each other, and also allows you to use the C-4500 as a 16-part multi-timbral tone generator.

## Parts of the C-4500 and their function

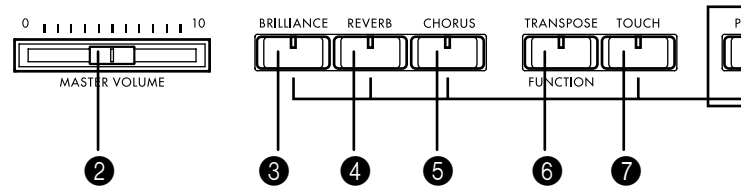
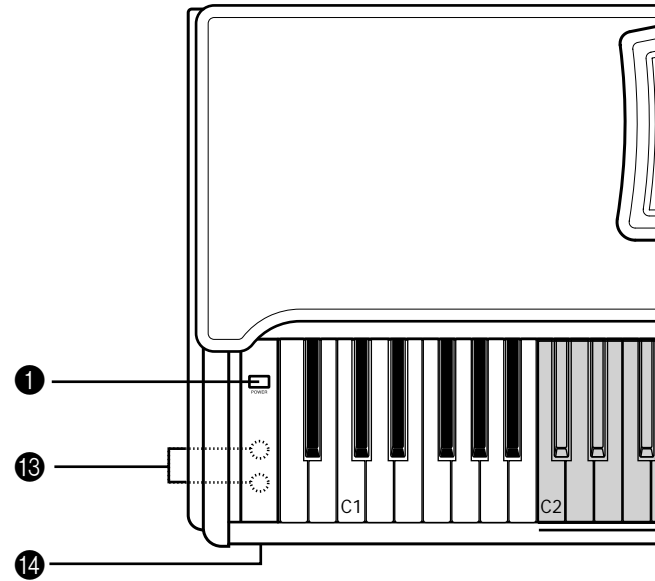

#### 1 [POWER] switch

This switch turns the power on or off. Each time you press it, the power will be turned on or off. (p.7)

#### 2 [MASTER VOLUME] slider

This slider controls the volume that is output from the speakers, headphones, and outputs. (p.7)

#### 3 [BRILLIANCE] switch

This switch sets the brightness of the sound. (p.11)

#### 4 [REVERB] switch

This switch applies reverberation to the sound (p.11).

#### 5 [CHORUS] switch

This switch adds spaciousness to the sound (p.10).

#### 6 [TRANPOSE/FUNCTION] switch

This switch is used to make MIDI-related settings (p.20), and to transpose the pitch (p.14). It is also used to make various other settings.

#### 7 [TOUCH] switch

This switch lets you select the keyboard touch. (p.14)

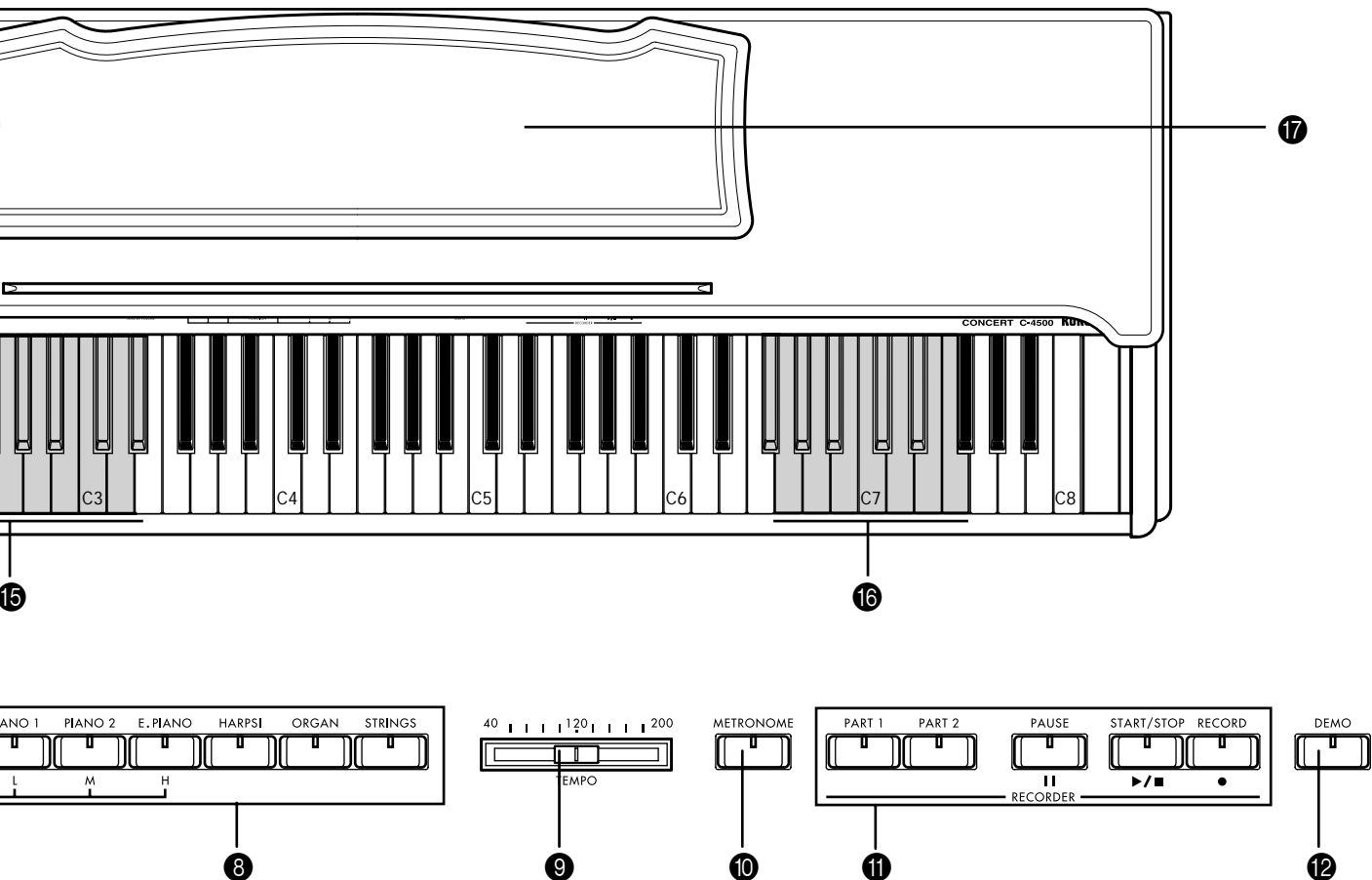

**8 [Sound selector] switches**

These switches are used to select sounds. You can also play using two sounds simultaneously (Layer functions).

You can select from six different sounds: [PIANO 1], [PIANO 2], [E.PIANO], [HARPSI], [ORGAN], and [STRINGS]. (p.11)

**9 [TEMPO] slider**

This slider adjusts the tempo of the metronome and recorder (p.13).

**10 [METRONOME] switch**

This switch starts/stops the metronome (p.13).

**11 [RECORDER] controls**

These are used to record/playback your performance (p.17).

**12 [DEMO] switch**

This switch plays the built-in demo songs. (p.9)

**13 PHONES jack (located on the bottom panel)**

A set of stereo headphones can be connected to this jack. (p.7)

**14 Power indicator (p.7)**

**15 MIDI channel keys**

These keys are used to set the MIDI channel (p.20).

**16 Transpose keys (F#6–F7)**

These keys are used to specify the transposition. (p.14)

**17 Music stand (p.7)**

# Switch functions

By pressing two switches simultaneously, you can access the following functions.

## ○ [Sound selector] switches

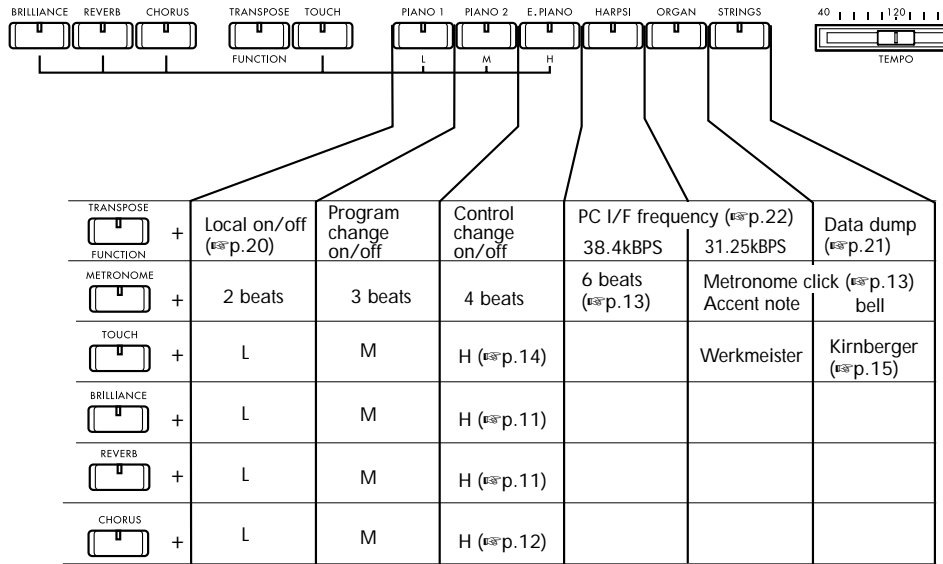

## ○ Recorder section

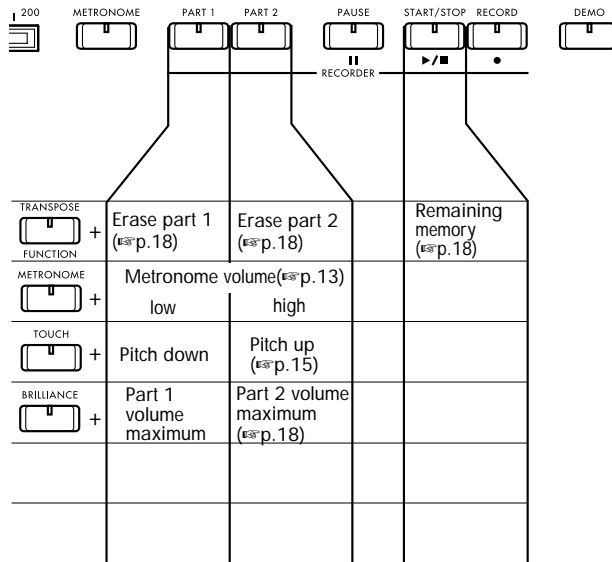

## ○ Keyboard

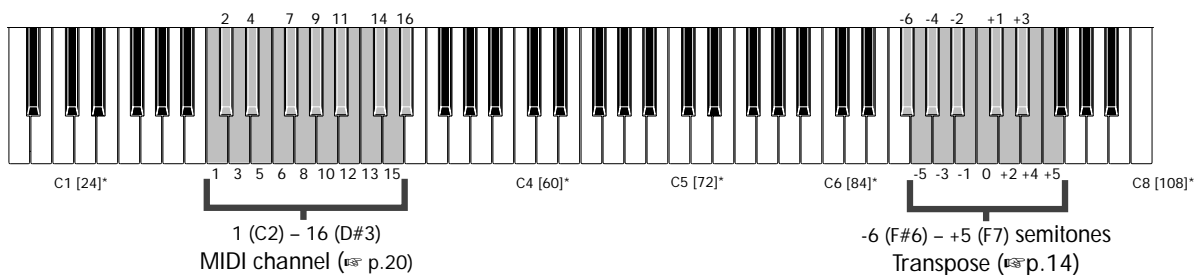

## Preparations for playing

### Before you begin playing

#### 1. Plug in the power cable.

Plug the power cable into an outlet.  
Make sure that the AC outlet is **the correct voltage** for your piano.

#### 2. Open the keyboard cover.

Lightly lift the center of the front edge, and support it as you slide the cover gently away from yourself.



To close the keyboard cover, lightly lift the center of the front edge, and slide it toward yourself.



Be careful not to pinch your fingers or hands when opening or closing the keyboard cover.



The cover may be damaged if you apply excessive force or open it roughly.



When opening the keyboard cover, make sure that no objects such as papers or coins are resting on top of the keyboard cover. Such objects may fall into the instrument.

#### 3. Turn on the power.

Press the [POWER] switch to turn on the power.



When the power is turned on, the power indicator located at the left side of the piano will light.

**To turn off the power**, press the [POWER] switch once again.

When the power is turned off, the power indicator located at the left side of the piano will go dark.

#### 4. Adjust the volume.

Use the [MASTER VOLUME] slider to control the volume that is output from the built-in speakers, the headphone jack, and the rear panel [OUTPUT] jacks.



Raise the [MASTER VOLUME] slider to the middle position. The volume will increase as you move the slider toward the right, and will decrease as you move it toward the left. At the “0” position, there will be no sound.

While playing the instrument, adjust the volume to an appropriate level.

### When using headphones

Insert the plug (1/4" phone plug) of your stereo headphones into the headphone jack located at the left side of the bottom panel of the instrument.

If headphones are plugged in, no sound will be output from the built-in speakers.

Use headphones when you do not wish to be heard by those around you, such as when playing at night.

Since two headphone jacks are provided, you can enjoy playing together with another person.



When using headphones, protect your hearing by avoiding extended listening at high volumes.



If your headphones have a mini → phone jack conversion plug, grasp the conversion plug when plugging in or unplugging the headphones.

### When using the music stand

Raise the music stand, and use the two stoppers located at the back to prevent it from falling over.







## Listening to the demo songs

The C-4500 contains 18 demo songs. Listen to the demo songs to experience the C-4500's rich sounds and expressive potential.

1.	PIANO1	F.Chopin / Fantasy-Impromptu Op.66
2.	PIANO2	KORG Original / Harmony of Love
3.	E.PIANO	KORG Original / The Harp of Wind
4.	HARPSI	J.S.Bach / Italian Concert BWV971
5.	ORGAN	F.Mendelssohn / Wedding March
6.	STRINGS	J.S.Bach / Air on the G string
7.	PIANO1	L.v.Beethoven / For Elise
8.	PIANO2	W.A.Mozart / Sonata K.331
9.	E.PIANO	F.Burgmuller / "La chevaleresque" Op.100-25
10.	HARPSI	F.Mendelssohn / Springs Song Op.62-6
11.	ORGAN	R.Schumann / A Dream Op.15-7
12.	STRINGS	F.Chopin / Etude Op.10-3
13.	PIANO1	F.Chopin / Valse No.6 Db-major Op.64-1
14.	PIANO2	F.Chopin / Nocturne Op.9-2
15.	E.PIANO	C.Deubussy / "Arabesque" No.1
16.	HARPSI	C.Deubussy / "Clair de lune"
17.	ORGAN	E.Satie / "Gymnopedie" No.1
18.	STRINGS	E.Elgar / "Salut d'Amour"

To listen to all songs consecutively

### 1. Press the [DEMO] switch.

The [Sound selector] switch indicators will light successively, and the C-4500 will enter demo mode.



### 2. Press the [START/STOP] switch.

Songs number 1 through 18 will playback successively.

When the last song finishes playing, playback will continue from the first song.

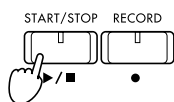

During playback, you can press a [Sound selector] switch to change to repeatedly playing the bank of the currently playing song (songs 1–6, songs 7–12, or songs 13–18). For example if you press the [STRINGS] sound selector switch while song number 1 is playing, song number 6 will be played, and then playback will continue repeating from song 1 through song 6.

Selecting a specific demo song

### 1. Press the [DEMO] switch.

The [Sound selector] switch indicators will light sequentially.

By pressing a [Sound selector] switch at this time, you can select and play songs 1–6.

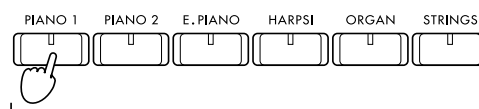

Press to select a song

### 2. Press the [DEMO] switch once again.

All [Sound selector] switch indicators will blink in unison.

By pressing a [Sound selector] switch at this time, you can select and play songs 7–12.

### 3. Press the [DEMO] switch once again.

Adjacent [Sound selector] switch indicators will blink alternately.

By pressing a [Sound selector] switch at this time, you can select and play songs 13–18.

### 4. If you press the [DEMO] switch once again at this time, you will exit Demo mode.

You can also exit Demo mode by pressing the [DEMO] switch while a demo song is playing.

## Practicing along with a demo song

You can use various operations to play along with a piano demo song.

Listening to the right hand and left hand parts separately

For demo songs 7–18, the right hand part and left hand part can be played back separately.

You can playback just one part of the demo playback and mute the other, and practice playing it yourself.

### 1. Press the [PART 1] or [PART 2] switch.

When you press the desired switch, its indicator will blink, and that part will be muted (silenced).

If you press the [PART 1] switch, the left hand part will be muted. If you press the [PART 2] switch, the right hand part will be muted.

### 2. To cancel muting, press the part switch whose indicator is blinking, to make the indicator light steadily.

Pausing the demo playback

#### ○ During playback, press the [PAUSE] switch to pause the playback.

When you once again press [PAUSE] or the [START/STOP] switch, the playback will continue.

Changing the tempo of the demo playback

#### ○ While the demo is playing or stopped, use the [TEMPO] slider to adjust the tempo. (p.13)



While the demo is playing, it is not possible to use the [Sound selector] switches to change the sound. Also, the metronome will not function during demo playback.



The tempo of the demo playback will not match the markings of the [TEMPO] slider. The center position of the slider (120) will be the original tempo specified for the song.



# Playing the C-4500

## 1. Selecting a sound

- Press a [Sound selector] switch to select the desired sound.

The indicator of the [Sound selector] switch you pressed will light.

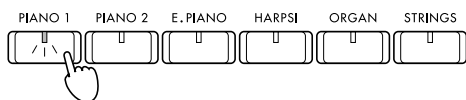

The following sounds can be selected.

PIANO 1	Piano 1: A deep and rich stereo grand piano with sparkling reverberation
PIANO 2	Piano 2: A clear and bright grand piano
E.PIANO	Electric piano 1: A light and transparent electric piano sound
HARPSI	Harpichord: A delicate harpichord with a classical flavor
ORGAN	Organ: A solemn pipe organ sound
STRINGS	Strings: The sound of an ensemble with violin and other string instruments

## Playing two sounds together (the Layer function)

You can cause two sounds (for example [PIANO 1] and [STRINGS]) to be heard simultaneously when you play a note. This is called **the Layer function**.

1. Simultaneously press two [Sound selector] switches.

The indicators of the two [Sound selector] switches you pressed will light. Up to 32 notes can be played simultaneously. (Up to 21 notes if PIANO 1 is selected.)

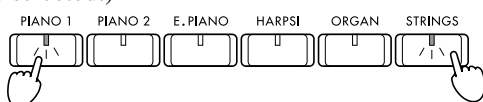

2. To turn off the Layer function, press a single [Sound selector] switch.

## Adjusting the volume balance of the two sounds

- While holding down the [Sound selector] switch for the instrument you wish to reduce the volume of, repeatedly press the [Sound selector] switch for the instrument you wish to increase the volume of.

When you have set the desired balance, use the [MASTER VOLUME] slider to adjust the volume.

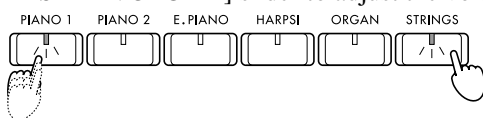

**MeMO** The volume balance is remembered even after the Layer function is cancelled, and after the power is turned off.

## 2. Adding effects to the sound

### Adjusting the brightness

The brightness can be adjusted independently for each sound. This setting is remembered for each sound until you change it.

1. Hold down the [BRILLIANCE] switch, and press either the [PIANO 1/L], [PIANO 2/M], or [E.PIANO/H] sound selector switch to select the brightness of the tone.

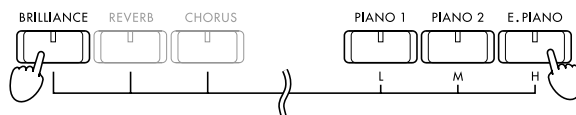

PIANO 1/L	MELLOW: The tone will become more muted.
PIANO 2/M	NORMAL: The "MELLOW" or "BRIGHT" settings will be cancelled, and the tone will return to normal.
E.PIANO/H	BRIGHT: The tone will become brighter.

2. To check the currently selected brilliance, hold down the [BRILLIANCE] switch.

The indicator of either the [PIANO 1/L], [PIANO 2/M], or [E.PIANO/H] sound selector switch will light to indicate the current brilliance setting.

### Adding reverberation

You can add reverberation and depth to the sound currently selected by the [Sound selector] switches, to create a sense of presence as though you playing in a concert hall. This is called **the reverb effect**.

The reverb effect can be set independently for each sound. This setting is remembered for each sound until you change it.

1. Hold down the [REVERB] switch, and press either the [PIANO 1/L], [PIANO 2/M], or [E.PIANO/H] sound selector switch to select the depth of reverb.

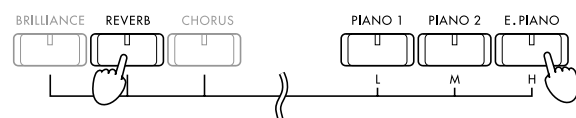

PIANO 1/L	Shallow reverb will be applied.
PIANO 2/M	Moderate reverb will be applied.
E.PIANO/H	Deep reverb will be applied.

2. To check the currently selected reverb depth, hold down the [REVERB] switch.

The indicator of either the [PIANO 1/L], [PIANO 2/M], or [E.PIANO/H] sound selector switch will light to indicate the current reverb depth.

3. If you do not want to apply reverb, press the [REVERB] switch.

Reverb will be turned off, and the [REVERB] switch indicator will go dark.

**MeMO** Since the [PIANO 1] and [PIANO 2] sounds simulate the string resonance of an acoustic piano, a small amount of reverb will remain even if reverb is turned off.

## Adding spaciousness

You can apply modulation to the sound currently selected by the [Sound selector] switches, to create a sense of spaciousness and richness. This is called the Chorus effect. The Chorus effect can be set independently for each sound. This setting is remembered for each sound until you change it.

1. **Hold down the [CHORUS] switch, and press either the [PIANO 1/L], [PIANO 2/M], or [E.PIANO/H] sound selector switch to select the depth of the chorus effect.**

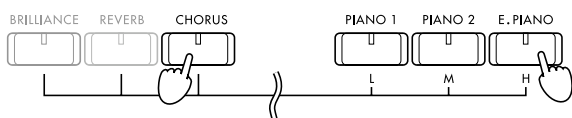

PIANO 1/L	The chorus effect will be applied lightly.
PIANO 2/M	The chorus effect will be applied moderately.
E.PIANO/H	The chorus effect will be applied deeply.

2. **To check the currently selected chorus depth, hold down the [CHORUS] switch.**  
The indicator of either the [PIANO 1/L], [PIANO 2/M], or [E.PIANO/H] sound selector switch will light to indicate the current chorus depth.
3. **If you do not want to apply the chorus effect, press the [CHORUS] switch to make the [CHORUS] switch indicator go dark.**

## 3. Using the pedals

This instrument has three pedals: damper, sostenuto, and soft. They can be used to make your performance more expressive.

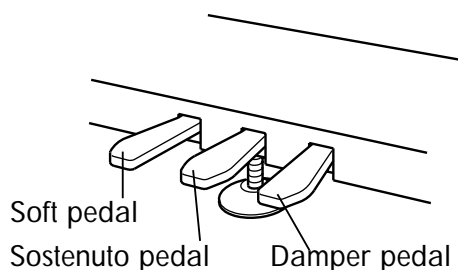

### Damper pedal

While you continue pressing the pedal, the sound will be sustained, and a rich resonance will be produced. The depth at which you press the pedal will adjust the degree of the damper effect (Half-damper effect).

### Sostenuto pedal

The damper effect will be applied only to notes which were already held while the pedal was pressed, so that these notes will continue sustaining while the pedal remains pressed. The damper effect will not apply to new notes that are newly played while the sostenuto pedal is already pressed.

### Soft pedal

The sound will be softer and more mellow while you press the pedal. The depth at which you press the pedal will adjust the softness of the sound (half-pedal effect).

## Pedal settings for Layer

You can select which sound will be affected by the damper pedal when the Layer function is used.

- **Hold down the [TRANSPPOSE/FUNCTION] switch, and press the damper pedal.**

The [Sound selector] switch to which the damper effect is applied will light.

Each time you press the damper pedal, the effect will cycle between being applied to “one [Sound select] switch” → “the other [Sound select] switch,” → “both [Sound select] switches.” After you have made the desired setting, release the [TRANSPPOSE/FUNCTION] switch.

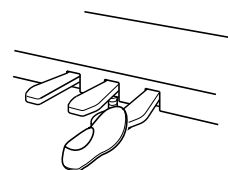

## 4. Playing with the metronome

If you wish to play at an accurate tempo, it is convenient to use the metronome. This metronome also sets the time signature and tempo used when you record a performance (p.17).

### Sounding the metronome

1. Press the [METRONOME] switch, and the metronome will start.

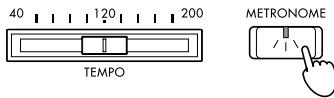

2. To stop the metronome, press the [METRONOME] switch once again.

### Adjusting the tempo

- Move the [TEMPO] slider to adjust the tempo. The tempo can be set in a range of  $\text{♩} = 40\text{--}200$ .

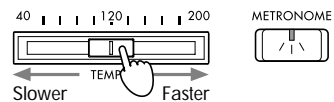

In some cases, the tempo may not match the markings on the [TEMPO] slider. Check the tempo in the LED display.

### Setting the time signature

1. Press the [METRONOME] switch to start the metronome.

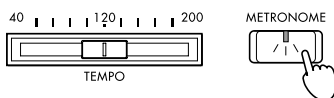

2. Hold down the [METRONOME] switch, and press the [Sound selector] switch that corresponds to the desired time signature.

The indicator of the [Sound selector] switch you pressed will light, and an accent note will occur at the beginning of the selected time signature.

If you do not want to hear an accent note, press the [Sound selector] switch whose indicator is lit so that the indicator goes dark, canceling the time signature setting.

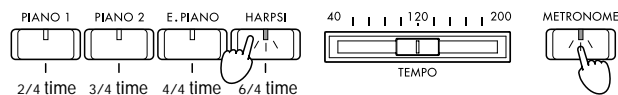

**MeMO** When the power is turned on, the time signature is automatically set to "4/4."

### Adjusting the volume

1. Press the [METRONOME] switch to start the metronome.

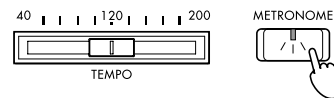

2. To increase the volume, hold down the [METRONOME] switch and repeatedly press the [PART 2] switch. To decrease the volume, hold down the [METRONOME] switch and repeatedly press the [PART 1] switch.

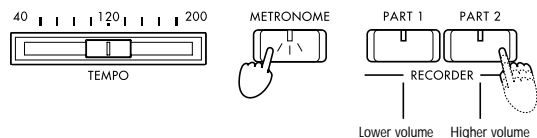

3. To restore the original metronome volume, hold down the [METRONOME] switch and simultaneously press the [PART 1] and [PART 2] switches.

**MeMO** The metronome volume setting is remembered even when the power is turned off.

### Selecting the accent note

The accented beat of the metronome can be changed to a bell sound.

1. Press the [METRONOME] switch to start the metronome.

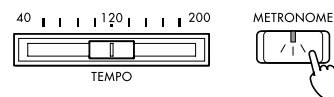

2. Hold down the [METRONOME] switch, and press the [STRINGS] sound selector switch. The [STRINGS] indicator will light, and a bell will sound at the beginning of the time signature. To return to the normal accent, hold down the [METRONOME] switch and press the [ORGAN] sound selector switch to make the [ORGAN] switch indicator light.

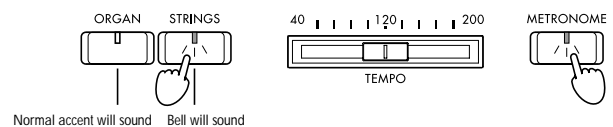

**MeMO** The selected accent sound is remembered even when the power is turned off.

## 5. Adjusting the keyboard touch

You can adjust the way in which the dynamics respond to your playing strength. This is called the Touch Control function.

1. Hold down the [TOUCH] switch, and press either the [PIANO 1/L], [PIANO 2/M], or [E.PIANO/H] sound selector switch to select the desired keyboard touch.

If you select either [PIANO 1/L] or [E.PIANO/M], the [TOUCH] switch indicator will light.

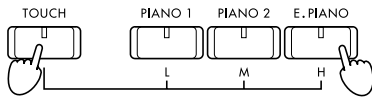

### PIANO1/L: LIGHT

Loud notes can be produced even by playing lightly. (Light touch)

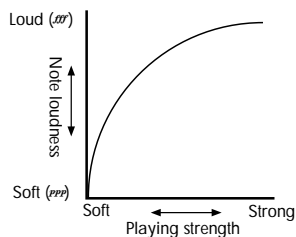

### PIANO2/M: STANDARD

Normal piano touch.

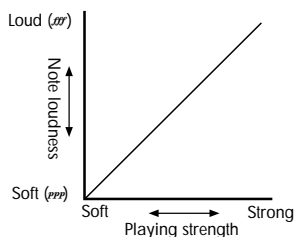

### E.PIANO/H: HEAVY

Loud notes will be produced only when you play strongly. (Heavy touch)

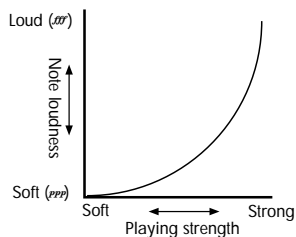

2. To check the currently selected touch, hold down the [TOUCH] switch.

The indicator of either the [PIANO 1/L], [PIANO 2/M], or [E.PIANO/H] sound selector switches will light to indicate the currently selected touch.

**MeMO** When the power is turned on, this will automatically be set to "STANDARD."

## 6. Changing keys (Transpose)

By changing the key (transposing), you can play a song using easier fingering that uses fewer black keys, or use familiar fingering to play a song at a pitch that matches another instrument or vocalist. This is called the Transpose function.

- Hold down the [TRANPOSE/FUNCTION] switch, and press a key in the range of F#6–F7. If you press any key other than C7, the [TRANPOSE/FUNCTION] switch indicator will light, indicating that the pitch is transposed. The pitch of the entire keyboard will be transposed so that the pitch of the note you pressed will correspond to the C7 note location. The pitch can be transposed in a range of 11 semitones.

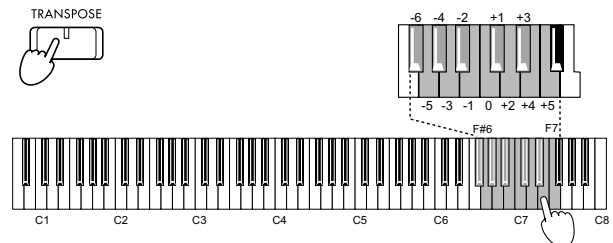
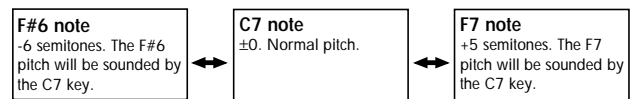

**MeMO** The transpose setting is automatically cancelled when the power is turned off.

### Example 1:

#### Raising the key of the song by a semitone

The C# pitch will now sound when you play the C note.

- Hold down the [TRANPOSE/FUNCTION] switch, and press the C#7 note. If the pitch is raised by a semitone as in this example, playing the notes shown at the left will sound the pitches shown at the right.

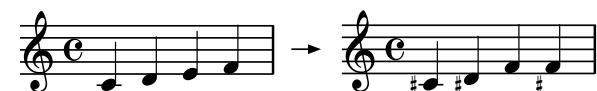

### Example 2:

#### Using G fingering to play a song in the key of Bb

The Bb pitch is a minor third (three semitones) above G. Thus, you need to make settings so that the D# pitch three semitones higher than C is heard when you play the C note.

- Hold down the [TRANPOSE/FUNCTION] switch, and press the D#7 note.

## 7. Adjusting the pitch

You can make fine adjustments to the pitch. This allows you to precisely match the pitch when playing with other instruments. The pitch can be adjusted in 0.5 Hz steps over a range of 427.5–452.5 Hz (Hertz).

### Raising the pitch

- **Hold down the [TOUCH] switch, and press the [PART 2] switch.**

Each time you press the switch, the pitch will be raised approximately 0.5 Hz.

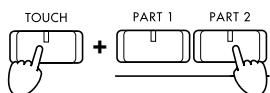

### Lowering the pitch

- **Hold down the [TOUCH] switch, and press the [PART 1] switch.**

Each time you press the switch, the pitch will be lowered approximately 0.5 Hz.

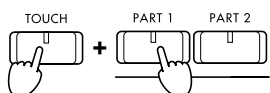

### Restoring the original pitch

- **Hold down the [TOUCH] switch, and simultaneously press the [PART 1] and [PART 2] switches.**

The pitch will return to the original setting (A4=440 Hz)

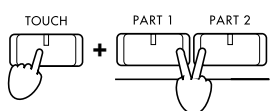

**MeMO** The pitch setting you make is remembered even when the power is turned off.

## 8. Selecting a temperament

There are numerous classical compositions that were composed using temperaments that differ from the “equal temperament” commonly used today. In order to reproduce the original sound of such compositions, the C-4500 provides Kirnberger and Werckmeister classical temperaments, in addition to the equal temperament widely used on keyboard instruments today, allowing you to select from a total of three temperaments.

### Werckmeister

This is the Werckmeister III scale invented by Andreas Werckmeister, the German organist and music theorist. This scale was created in the later Baroque period to allow relatively free transposition.

### Kirnberger

This is the Kirnberger III scale invented by Johann Phillip Kirnberger in the early 18th century, and is used mainly for tuning harpsichords.

### Equal temperament

Nearly all keyboard instruments today use equal temperament. This temperament spaces all semitones at equal distances, and allows identical scales to be played in any key.

### Changing the temperament

- **Hold down the [TOUCH] switch, and press either the [ORGAN] or [STRINGS] sound selector switch to select the desired temperament.**

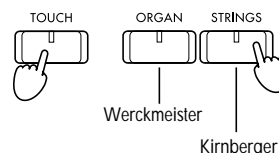

### Returning to equal temperament

- **Hold down the [TOUCH] switch, and press the [Sound selector] switch whose indicator is lit.**

**MeMO** When the power is turned on, equal temperament will be selected automatically.

### About stretched tuning

In order to produce the most natural resonance, [PIANO 1] and [PIANO 2] use a “stretched tuning” that makes the notes of the lower range slightly flatter than equal temperament, and the upper range slightly sharper.





# Recording / playing back your performance

The C-4500 contains a built-in recorder that lets you record and playback your performance as easily as using a tape recorder.

You can record your playing on two parts. These parts can be played back simultaneously to create a single song, or used to record two separate songs.

## 1. Recording your performance

### Recording your performance

1. Press a [Sound selector] switch to select the sound that you wish to record.

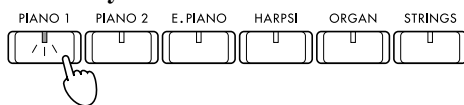

2. Press the [RECORD] switch.

The [RECORD] switch indicator will light.

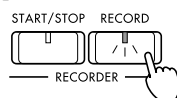

3. Press either [PART 1] or [PART 2] to select the part that you wish to record.

This will make the switch indicator blink red for the part that you wish to record. You can put only one of the parts in record-ready mode.

	<b>Dark</b>	This part contains no recorded data.
	<b>Blinking red</b>	Ready to record. Recording will occur on this part.
	<b>Lit green</b>	This part contains recorded data.
	<b>Blinking green</b>	Playback is muted. Select this state when you do not wish to hear this part while recording.

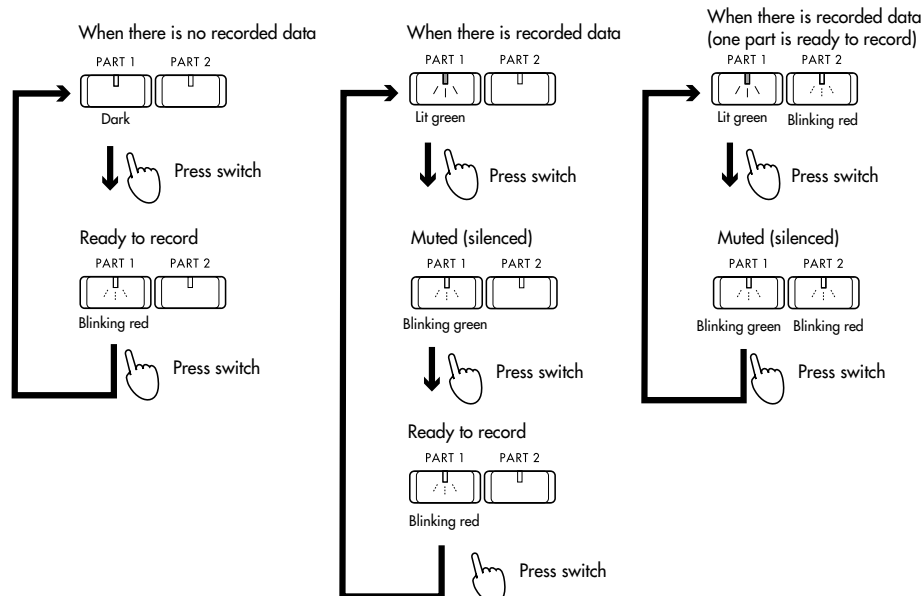

4. Recording will begin when you press either the [START/STOP] switch, a note, or a pedal, or when a MIDI message is received.

When the [START/STOP] switch is pressed, recording will begin after a two-measure count. During recording, the [START/STOP] switch indicator will blink in time with the time signature, red on the first beat and green on other beats.

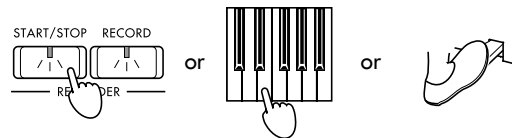

- When Layer is being used, pedal settings will be fixed at "Enable" for both sounds during recording.

- Never turn off the power during recording.

**MeMO** If you wish to record along with the metronome, you can turn on the metronome (see p.13).

5. Press the [START/STOP] switch to stop recording.

If you press the [PAUSE] switch, recording will pause at that location, and the [PAUSE] indicator will light.

Press the [RECORD] switch, select the [PART1(or2)], then play the keyboard to resume recording.

- Recording will overwrite the previous data, and the previously-recorded data will be erased.

- Recording may not always begin correctly from the paused location.

## 2. Playing back your recorded performance

To play back your recorded performance

1. **If there is recorded data, the indicator(s) of the [PART 1] and/or [PART 2] switches will light green.**

You can press the switch for a part that you do not wish to hear, making its indicator blink green so that the part will not play back.

2. **Press the [START/STOP] switch to begin playback.**

During recording, the [START/STOP] switch indicator will blink in time with the time signature, red on the first beat and green on other beats. You can use the [TEMPO] slider to adjust the playback tempo (see p.13). Changing the song tempo will not affect the pitch.

3. **To stop playback, press the [START/STOP] switch.**

The song will stop, and will automatically return to the first measure.

To pause the song, press the [PAUSE] switch. The song will pause at that location, and the [PAUSE] indicator will go dark.

Press either the [START/STOP] switch or the [PAUSE] switch to resume playback.

Playback will also stop when all the recorded data is played back, and the [START/STOP] switch indicator will blink.

-  If you press the [PAUSE] switch during playback, and then switch to recording at the location where you paused, recording may not always begin correctly from the paused location.

## Adjusting the balance between the two parts

- **When playing back PART 1 and PART 2 simultaneously, you can hold down the [BRILLIANCE] switch and press the switch (either [PART 1] or [PART 2]) of the part whose volume you wish to increase.**

To restore the original volume balance, hold down the [BRILLIANCE] switch, and simultaneously press the [PART 1] and [PART 2] switches.

## Repeatedly playing back the performance

You can make the entire recorded song play back repeatedly.

- **During playback, press the [TRANSPPOSE/FUNCTION] switch.**

The [TRANSPPOSE/FUNCTION] switch indicator will blink, and the song will playback repeatedly.

To stop playback, press the [START/STOP] switch. At this time, the repeat playback will also be cancelled.

## 3. Erasing recorded data

Erasing a part

1. **While playback is stopped, hold down the [TRANSPPOSE/FUNCTION] switch, and press either the [PART 1] or [PART 2] switch.**

The indicators of the [TRANSPPOSE/FUNCTION] switch and either the [PART 1] or [PART 2] switches will blink, and the C-4500 will be ready to erase recorded data.

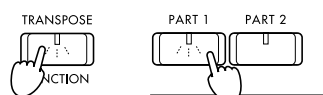

If you press the [TRANSPPOSE/FUNCTION] switch once again, you will exit erase-standby mode.

2. **Press either the [PART 1] or [PART 2] switch to erase the performance data.**

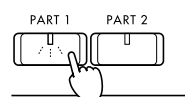

To see how much recording capacity remains

- **Simultaneously press and hold the [TRANSPPOSE/FUNCTION] switch and the [START/STOP] switch.**

The amount of performance data that has been recorded will be shown by the number of [Sound select] switch indicators that light. As more performance data is recorded, more of the indicators will light.

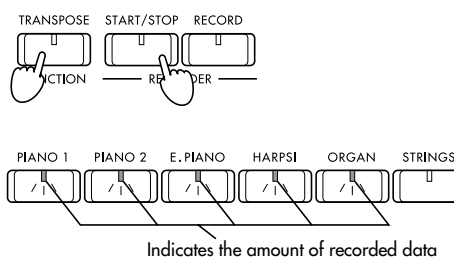

If during recording, the amount of available space decreases to less than 10 percent of the memory capacity (when less than 1,400 more notes can be recorded, or when over 900 measures have been recorded [out of a maximum of 999 measures]), the [RECORD] switch indicator will blink.

-  We recommend that you use a commercially available data filer to save any performance data that you wish to keep. (see p.21)

## Connecting other devices

### 1. Connecting a synthesizer or audio system

You can connect another keyboard, module or CD player into this instrument so that sound from the other device can be heard through the speakers/headphones of the C-4500, or connect the C-4500 to your audio system to record your playing on a tape recorder, etc.

#### INPUT jacks (L/MONO, R)

These jacks can be connected to the output jacks of another instrument (synthesizer etc.) or audio device, so that its sound can be heard through the speakers of the C-4500. To adjust the volume, use the volume control of the connected instrument or audio device.

#### OUTPUT jacks (L/MONO, R)

These jacks can be connected to the input jacks of an audio device to produce louder volumes, or to record your playing on a tape recorder etc. To adjust the volume, use the [MASTER VOLUME] slider of the C-4500.

#### MIDI connectors (IN, OUT)

These connectors can be connected to another MIDI device such as a synthesizer, sequencer, or rhythm machine, to trigger or exchange various types of data. Refer to "2. Connecting MIDI equipment," below.

#### PC (TO HOST) connector

This connector can be connected to your computer. For details refer to p.19.

#### PC/MIDI select switch

This switch selects whether you can use the MIDI connectors or the PC (TO HOST) connector.



The setting of the PC/MIDI select switch must be changed only when the power is off. Please do not attempt to use the PC connector at the same time as the MIDI connectors. Use only the connector(s) selected by the PC/MIDI select switch. If both sets of connectors are used, or if a set of connectors other than the selected setting is used, the device connected to the C-4500 may malfunction.

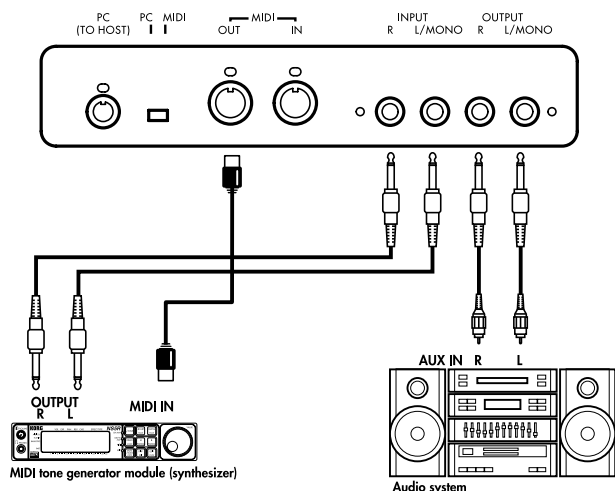

## 2. Connecting MIDI equipment

### What is MIDI?

MIDI (Musical Instrument Digital Interface) is a world-wide standard that allows a variety of musical data to be exchanged between electronic musical instruments and computers, etc.

By playing the C-4500, you can sound other instruments that are connected via MIDI. Sound selections and damper pedal operations etc. that you perform on the C-4500 will also control the connected MIDI device.

You can also control the C-4500 from another MIDI keyboard or sequencer (automatic playback device), causing the C-4500's internal tone generator to sound. By combining two or more MIDI devices, you can enjoy more colorful ensembles. MIDI is also used to save the recorder data of the C-4500.

This section will explain how MIDI can be used in ways relating to the C-4500. If you would like to learn more about MIDI, please refer to one of the many introductory books on MIDI that are commercially available.

### MIDI connections

Special MIDI cables are used to transfer MIDI data. These cables are connected between the MIDI connectors of the C-4500 and the MIDI connectors of the external MIDI device to (or from) which you want to transfer data. There are two types of MIDI connector.



If the PC/MIDI select switch is in the MIDI position, be sure that MIDI cables are connected to the MIDI jacks. If the PC/MIDI select switch is in the PC position, first turn off the power of the C-4500, and then set the PC/MIDI select switch to the MIDI position.

### MIDI IN connector

MIDI messages are received at this connector. This connector can be used to play the C-4500's sounds from an external MIDI device (MIDI keyboard or sequencer etc.). Use a MIDI cable to connect the MIDI IN of the C-4500 to the MIDI OUT of the external MIDI device.

### MIDI OUT connector

MIDI messages are transmitted from this connector. The MIDI messages transmitted when you play the keyboard of the C-4500 can be transmitted to an external MIDI device to control it. Use a MIDI cable to connect the MIDI OUT connector of the C-4500 to the MIDI IN connector of the external MIDI device.

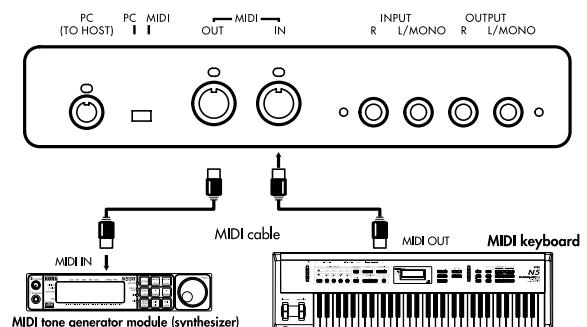

## MIDI channel

When you have finished making MIDI connections, set the C-4500 and the connected MIDI device to the same MIDI channel. There are sixteen MIDI channels: 1–16.

- Hold down the [TRANSPOSE/FUNCTION] switch, and press a note in the range of C2–D#3 that corresponds to the desired MIDI channel.

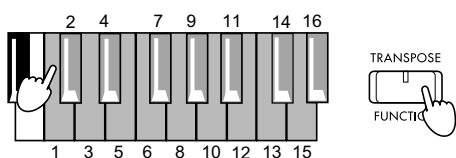

**MeMO** When the power is turned on, this will automatically be set to MIDI channel 1. making settings, press the [MIDI] switch.

## Using the C-4500 as a multi-timbral tone generator

When the internal tone generator of the C-4500 is controlled from an external MIDI device, it can function as a 16-part multi-timbral tone generator.

1. Use a MIDI cable to connect the C-4500's MIDI IN to the MIDI OUT of a sequencer etc.
2. Transmit MIDI data from the connected sequencer etc.

The MIDI receive channels correspond to the sound of the C-4500 as described below.

For details on transmitting data from the connected sequencer etc., refer to its owner's manual.

If program change messages are received together with the musical data, the C-4500's sounds that correspond to the received program numbers will be used.

However, this will occur only if program changes are enabled for the relevant MIDI channel. Program changes and control changes can be cancelled independently for each MIDI channel 1–16.

## Local on/off setting

If you do not want the internal tone generator of the C-4500 to sound when you play its keyboard (i.e., so that only the external MIDI device is heard), or when you have connected an external sequencer and do not want the data echoed back (retransmitted) by the sequencer to sound duplicate notes on the C-4500, you can turn off the Local setting of the C-4500. Normally, you will leave Local turned on, so that playing the C-4500's keyboard will sound its internal tone generator.

- Hold down the [TRANSPOSE/FUNCTION] switch, and press the [PIANO 1] sound select switch.

The Local setting will alternate on/off each time you press the switch.

Local On	[PIANO 1] indicator lit
Local Off	[PIANO 1] indicator dark

**MeMO** When the power is turned on, this setting will automatically be Local On.

## Program changes

Program change messages can be transmitted from the C-4500 to a connected MIDI device to select sounds, or transmitted from a connected MIDI device to select sounds on the C-4500.

## Transmitting program changes

Program numbers on a connected external MIDI device can be switched from the C-4500.

- When you use the [Sound selector] switches to switch sounds, a MIDI program change number of 0–20 will be transmitted as shown in the table on blow.

## Receiving program changes

When a program change number is received from an external device, the C-4500 will switch timbre sounds as shown in the following table.

**MeMO** This instrument will switch sounds when it receives MIDI program numbers 0–20. If MIDI program numbers above 21 are received from the external MIDI device, the C-4500 will not switch sounds.

	PC#	Sound
Single	0	PIANO1
	1	PIANO2
	2	E.PIANO
	3	HARPSI
	4	ORGAN
	5	STRINGS
Layer	6	PIANO1+PIANO2
	7	PIANO1+E.PIANO
	8	PIANO1+HARPSI
	9	PIANO1+ORGAN
	10	PIANO1+STRINGS
	11	PIANO2+E.PIANO
	12	PIANO2+HARPSI
	13	PIANO2+ORGAN
	14	PIANO2+STRINGS
	15	E.PIANO+HARPSI
	16	E.PIANO+ORGAN
	17	E.PIANO+STRINGS
	18	HARPSI+ORGAN
	19	HARPSI+STRINGS
	20	ORGAN+STRINGS

## Program change cancel

If you do not want to transmit or receive program changes, you can Cancel program changes. If you do want to transmit and receive program changes, you can Enable program changes.

- Hold down the [TRANSPOSE/FUNCTION] switch, and press the [PIANO 2] sound selector switch.

Each time you press the switch, the setting will alternate between Enable and Cancel.

Enable	[PIANO 2] indicator lit
Cancel	[PIANO 2] indicator dark

The program change cancel setting can be made independently for each MIDI channel 1–16. For

example if you select program change cancel for MIDI channel 1, and later change the MIDI channel to channel 2, the program change cancel setting of channel 1 will still be remembered.

**MeMO** When the power is turned on, program changes will be enabled for all MIDI channels.

## Control changes

Operations of the C-4500's damper pedal etc. can be transmitted to control a connected external MIDI device, or damper pedal data etc. from an external MIDI device can be received by the C-4500 to control it. If you wish to transmit and receive this data, you can Enable control changes. If you do not wish to transmit or receive this data, you can Cancel control changes.

- **Hold down the [TRANPOSE/FUNCTION] switch, and press the [E.PIANO] sound selector switch.**

Each time you press the switch, the setting will alternate between Enable and Cancel.

Enable	[E.PIANO] indicator lit
Cancel	[E.PIANO] indicator dark

The control change cancel setting can be made independently for each MIDI channel 1–16. For example if you select control change cancel for MIDI channel 1, and later change the MIDI channel to channel 2, the control change cancel setting of channel 1 will still be remembered.

 Control changes from an external device will always apply to both sounds in a Layer, regardless of the C-4500's pedal setting (see p.12 "Pedal settings for Layer").

**MeMO** When the power is turned on, control changes will be enabled for all MIDI channels.

## Synchronizing with an external sequencer

An external sequencer or rhythm machine connected via MIDI can playback in synchronization with the C-4500's built-in recorder.

The C-4500 will function as the master device (the device that controls the other device(s)), so the connected sequencer or other device will be the slave (the device that is controlled).

1. **Use a MIDI cable to connect the C-4500's MIDI OUT to the MIDI IN of the sequencer etc.**

2. **Set the connected sequencer or other device(s) to function as the slave.**

For details on MIDI clock settings etc. for the connected MIDI device, refer to its owner's manual.

3. **Press the [START/STOP] button of the C-4500 to begin synchronized playback.**

The MIDI Clock (messages that indicate the tempo) transmitted by the C-4500 will follow the setting of the [TEMPO] slider.

## Saving recorder data (Data dump)

Musical data that was recorded on the C-4500's recorder can be saved on an external MIDI data filer (storage device), and later re-loaded back into the C-4500's recorder for playback when desired.

 Carefully read the owner's manual for your data filer so that the data is not lost.

- **Saving the musical data to the data filer**

1. Use a MIDI cable to connect the C-4500's MIDI OUT to the MIDI IN of the data filer.
2. Operate the data filer so that it is ready to receive MIDI data from the C-4500.
3. Hold down the [TRANPOSE/FUNCTION] switch of the C-4500, and press the [STRINGS] sound selector switch.

The [TRANPOSE/FUNCTION] and [STRINGS] switch indicators will blink, and the C-4500 will be ready to transmit the data dump.

4. Press the [START/STOP] switch.

The data dump will begin, and the musical data will be transmitted to the data filer. While the data is being transmitted, the [START/STOP] switch indicator will blink.

When transmission is completed, the [START/STOP] switch indicator will go dark, and you will return to normal playing condition.

 The C-4500 will not produce sound while it is waiting to receive a data dump or ready to transmit data to a data filer. When data transmission is completed and the data has been recorded on the data filer, the C-4500 will return to normal playing condition.

- **Restoring musical data from the data filer to the C-4500's recorder**

1. Use a MIDI cable to connect the MIDI IN of the C-4500 to the MIDI OUT of the data filer.
2. Hold down the [TRANPOSE/FUNCTION] switch of the C-4500, and press the [STRINGS] sound selector switch.

The [TRANPOSE/FUNCTION] and [STRINGS] switch indicators will blink, and the C-4500 will wait to receive the data dump.

3. Operate your data filer to make it transmit the musical data that was previously saved from the C-4500. (For details on data transmission, refer to the owner's manual of your data filer.)

The C-4500 will receive the musical data. While the data is being received, the [RECORD] indicator will blink.

When reception of the musical data is completed, the [RECORD] switch indicator will go dark, and the C-4500 will return to the condition it was in prior to waiting for the data dump.

 The C-4500 will not produce sound while waiting to receive musical data from the data filer. After the data has been received and has been correctly stored into the C-4500's recorder memory, the C-4500 will return to normal playing condition.

### 3. Connecting a computer

A special PC I/F cable can be used to connect the C-4500 to your computer, allowing the C-4500 to be played from your computer or a performance on the C-4500 to be recorded on your computer in the same way as when using MIDI.

The C-4500 can be connected using a special PC I/F cable to an IBM PC compatible or to an Apple Macintosh computer.



The PC/MIDI select switch must be moved only when the power is turned off.



If the PC/MIDI select switch is in the PC position, you must connect a special PC I/F cable (not include) to the PC (TO HOST) connector.



On the C-4500, setting the PC/MIDI select switch to the MIDI position will automatically set the synchronization frequency to 31.25 kbps. Even if you subsequently set the PC/MIDI select switch to the PC position, it will remain at 31.25 kbps. Change the setting as necessary.

#### PC (TO HOST) connector

This connector allows the C-4500 to be controlled from a computer, or the C-4500 to send MIDI messages to a computer. Use a PC I/F cable of a type appropriate for your computer to connect the C-4500's PC (TO HOST) connector to your computer.

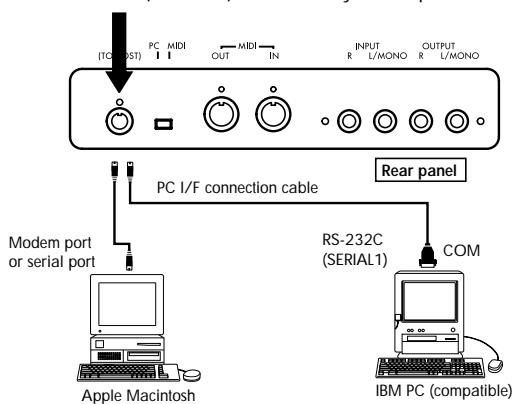

#### Connecting an IBM PC compatible

Make connections using the AG-001B connection kit (connection cable, "Korg MIDI Driver" software [sold separately]).

However, applications that do not support Windows cannot be used with this type of connection unless they specifically support the C-4500.

1. Use the special connection cable (AG-001B [sold separately]) to connect the serial port (COM port) of the IBM PC compatible to the PC (TO HOST) connector of the C-4500.

If your computer has a 25 pin serial port, you will need to obtain a 9 pin – 25 pin adapter.

2. Hold down the [TRANPOSE/FUNCTION] switch, and press the [HARPSI] sound selector switch.

The synchronization frequency will be set to 38.4 kbps.

3. If you are using Windows, install the Korg MIDI Driver.

For the installation procedure, refer to the separate sheet.

#### Connecting an Apple Macintosh series computer

Make connections using the AG-002B connection kit (connection cable, "Korg MIDI Driver" software [sold separately]).



It is not possible to make connections via the TO HOST connector with a Macintosh that does not have serial ports (modem/printer).

1. Use the special connection cable (AG-002B [sold separately]) to connect the modem port or printer port of the Apple Macintosh to the PC (TO HOST) connector of the C-4500.

2. Hold down the [TRANPOSE/FUNCTION] switch, and press the [ORGAN] sound selector switch.

The synchronization frequency will be set to 31.25 kbps.

3. If you wish to use the Korg MIDI Driver, refer to the separate sheet.

## Troubleshooting

### Power does not turn on

- Is the power cable connected to an appropriate AC outlet? (☞p.7)
- Is the power switch turned on? (☞p.7)
- If the power still does not turn on, disconnect the power cable from the AC outlet, and contact a nearby Korg service center.

### No sound

- Is the [MASTER VOLUME] slider raised? (☞p.7)
- Have headphones been plugged in? (☞p.7)
- Has the currently selected part been muted? (☞p.15)
- Make sure that the Local setting is turned ON. (☞p.17)

### Notes are interrupted

- The sounds of the C-4500 are produced by sampling (recording) the sounds of actual instruments, and processing or analyzing them. Some sounds play one piece of sampled data when a note is played (mono), while other sounds play two pieces (stereo).

The [PIANO 1] sound is stereo, so the maximum number of notes that can be played simultaneously (i.e., the polyphony) will be 32 notes, even if the damper pedal is pressed. For other sounds, the polyphony is 64 notes.

When using the Layer function to play two sounds simultaneously, the polyphony will differ depending on whether the sounds are mono or stereo. For example if a mono sound that uses one sample is played together with a stereo sound that uses two samples, the polyphony will be 21 notes. When using the Layer function, or when recording multiple parts on the recorder, be aware of how the sounds are combined in order to make the most effective use of the available polyphony.

### The pitch or tone of piano sounds is wrong in certain key ranges

- The piano sounds of the C-4500 are designed to simulate the sounds of a real piano as accurately as possible. For this reason, it may sound as though there is something unusual about the pitch or tone, such as an emphasis in the overtones of certain ranges. This is not a malfunction.

### Pedal effects do not apply correctly

- Has the pedal connector been disconnected? (☞p.23)

### Cannot record

- Is there sufficient space on the recorder? (☞p.15)

### An external device does not respond to transmitted MIDI data

- Make sure that MIDI cable or special PC connection cable connections are correct. (☞p.16)
- Make sure that the C-4500 is transmitting MIDI data on the channel that the receiving device is set to receive. (☞p.17)

### Cannot set the synchronization frequency

- Is the PC/MIDI select switch in the MIDI position? (☞p.19)  
If this is in the MIDI position, the synchronization frequency will always be set to 31.25 kbps.

## Specifications

<b>Keyboard</b>	88 note (A0–C8)
<b>Sounds</b>	6 sounds: Piano 1, Piano 2, Electric piano, Harpsichord, Organ, Strings
<b>Tone generator system</b>	HI synthesis system
<b>Polyphony</b>	64 notes
<b>Effects</b>	Reverb (3 levels), chorus (3 levels), brilliance (3 levels)
<b>Recorder</b>	2 parts (maximum capacity 14,000 notes) Tempo, Metronome, Record, Start/stop, Pause
<b>Keyboard modes</b>	Single, Layer
<b>Temperaments</b>	3
<b>Touch control</b>	3 levels (light/standard/heavy)
<b>Controls</b>	Power switch, Master Volume slider, Transpose/Function switch, Touch switch, sound selectors, Tempo slider, Metronome switches, Demo switch, PC/MIDI select switch
<b>Pedals</b>	Damper*, Soft*, Sostenuto (*: supports half-pedaling)
<b>Connectors</b>	PHONES x 2, INPUT (L/MONO, R), OUTPUT (L/MONO, R), MIDI (IN, OUT), PC (TO HOST)
<b>Main amp</b>	24 W x 2
<b>Speakers</b>	16 cm x 2
<b>Power supply</b>	AC 117V or AC 230V
<b>Power consumption</b>	55W(117V), 60W(230V)
<b>Dimensions</b>	1379 (W) x 458 (D) x 875 (H) mm
<b>Weight (with stand)</b>	45.5 kg
<b>Included items</b>	Stand
<b>Options</b>	AG-001B, AG-002B connection kits

\*Specifications and appearance are subject to change without notice for product improvement.

· Other product names and company names are registered trademarks and trademarks of their respective owners.

· Sound processed with INFINITY (TM).



# Assembling the ST-4500



## Caution

Use two or more people to assemble the stand. When placing the piano on the stand, be careful not to pinch your hand.

Be sure that the correct parts are assembled in the correct orientation, and follow the steps in the order that they are given.

If you apply weight to the front edge of the piano before tightening the screws, the piano may fall down.

### 1. Open the packing carton and remove the contents.

Check that all of the following items are present.

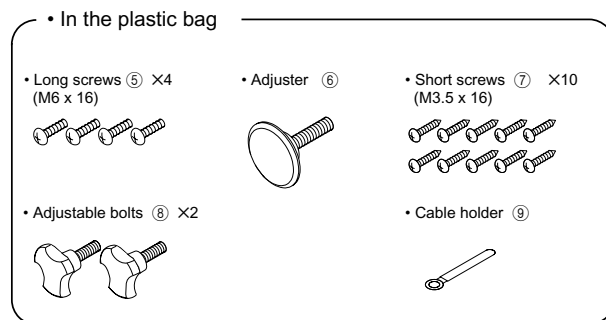
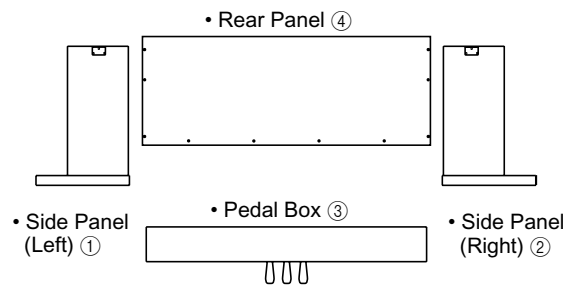

### 2. Attach the side panel (left) ① and side panel (right) ② to the pedal box ③, and use four long screws ⑤ to fasten them.

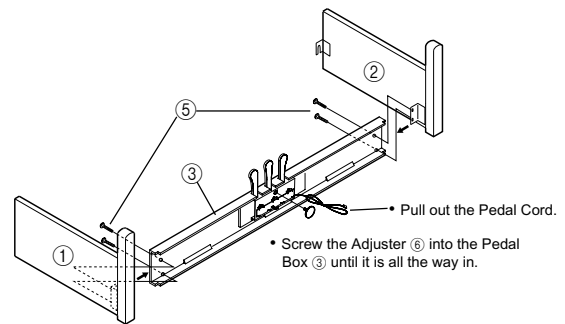

### 3. Attach the back panel ④.

Use four short screws ⑦ to fasten the bottom edge of the back panel ④, and four screws ⑧ to fasten the sides. Use one short screw ⑦ to fasten the cable holder to the back panel.

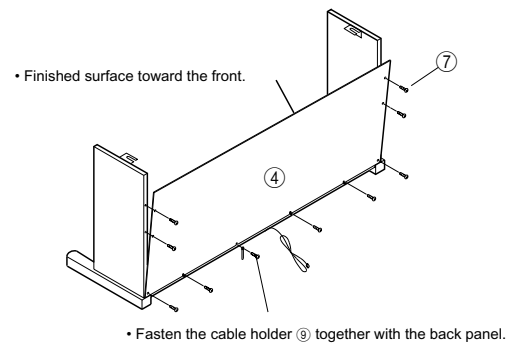

○ At this time, make sure that there are no gaps in the stand, and that it does not tilt.

### 4. Attach the piano.

Place the piano on the stand so that the plastic feet on the bottom of the piano fit into the holes in the side panel brackets. From below, use four adjustable bolts ⑩ to fasten the piano to the stand.

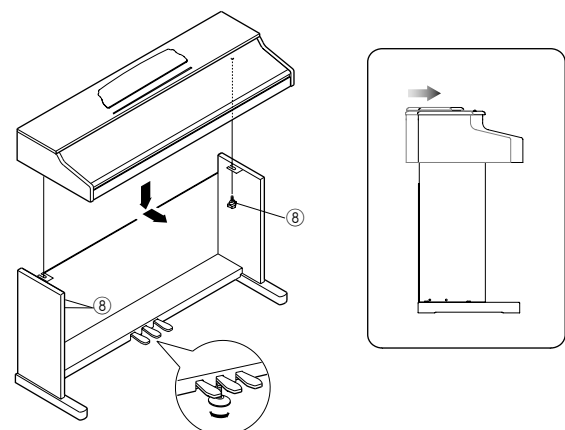

▲ Rotate the adjuster so that it firmly contacts the floor. If the adjuster is not in firm contact with the floor, the pedal may wobble and cause malfunctions.

**5. Connect the pedal cable and power cable, and fasten them.**

Connect the power cable included with the piano to the socket located on the back of the piano.

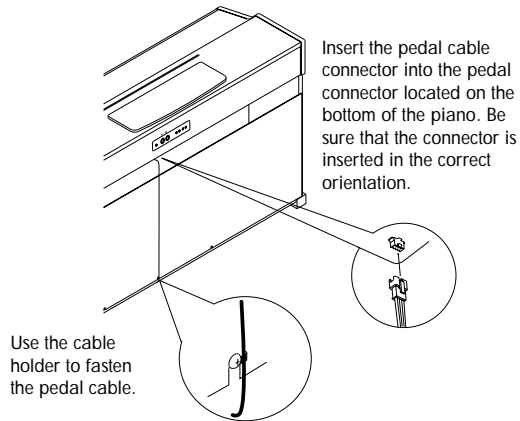

**Check after assembly**

**[ ] Are any parts left over?**

If any parts are left over, check the diagrams to see where they should be used.

**[ ] Make sure that all screws are tight.**



**Caution**

**Caution when transporting the instrument**

Remove the piano from its stand, and transport them separately. After transportation, refer to these instructions and re-assemble the piano and stand.

**Loosened screws**

After assembly, the various screws of the stand may loosen after prolonged use, causing the stand to wobble. If this occurs, re-tighten the screws.

**Disassembly**

If you need to pack up the C-4500, reverse the order by which the piano was attached to the stand and the stand was assembled. After disassembly, save the screws and other parts so that no parts are lost.



Place the piano at a distance from the wall, so that the power supply cable on the back panel is not strained.

## MIDI Implementation Chart

Function		Transmitting	Receiving	Remarks
Basic channel	Default Changed	1 1-16	1-16	
Mode	Default Message Altered	X *****	3 X	
Note number	True Voice	15-113 *****	0-127 21-108	
Velocity	Note ON Note OFF	O9n, V=1-127 X	O9n, V=1-127 X	
Afertouch	Key's Ch's	X X	X X	
Pitch bender		X	X	
Control change				
	7	O	O	Volume
	11	O	O	Expression
	64	O	O	Damper pedal *1, *3
	66	O	O	Sostenuto pedal *1
	67	O	O	Soft pedal *1, *3
	120, 121	O	O	All sound off, Reset all controllers
Prog change	True#	0-20 *****	0-20 0-20	*2
Exclusive		O	O	Device Inquiry Sequence Data Dump
Common	:Song position :Song select :Tune	X X X	X X X	
Realtime	:Clock :Commands	O O	X X	
Aux message	:Local ON/OFF :All notes OFF :Active sensing :Reset	X O O X	O O123-127 O X	
Remarks	*1: Transmitted/received when control changes are enabled *2: Transmitted/received when program changes are enabled *3: Half-pedal output value (0, 38, 74, 127)			

Mode 1: OMNI ON, POLY

Mode 2: OMNI ON, MONO

O: Yes

Mode 3: OMNI OFF, POLY

Mode 4: OMNI OFF, MONO

X: No

\* Consult your local Korg distributor for more information on MIDI Implementation.

**NOTICE**

KORG products are manufactured under strict specifications and voltages required by each country. These products are warranted by the KORG distributor only in each country. Any KORG product not sold with a warranty card or carrying a serial number disqualifies the product sold from the manufacturer's/distributor's warranty and liability. This requirement is for your own protection and safety.

**KORG** KORG INC.

15 - 12, Shimotakaido 1 - chome, Suginami-ku, Tokyo, Japan.