



V304

GUITAR AMPLIFIER  
HEAD

USER'S GUIDE

**Table of Contents:**

**The Front Panel** ..... 4

**The Rear Panel** ..... 5

**Piggy Back Mounting onto the V212T Speaker Cabinet** ..... 6

**Important Information About Tubes and Tube Products**

**A Brief History Of The Tube** ..... 7

**Tube Types and Usage** ..... 7,8













**The Nature of Tubes: Why (and When) to Replace Them** ..... 8,9

**The Importance of Proper Biasing** ..... 9

**Survival Tips For Tube Amplifiers** ..... 10

**System Block Diagram** ..... 11

**Technical Specifications** ..... back cover

 <p style="text-align: center;"><b>CAUTION</b></p> <p style="text-align: center; font-size: small;">RISK OF ELECTRIC SHOCK DO NOT OPEN</p> 	 <p style="text-align: center;"><b>PRECAUCION</b></p> <p style="text-align: center; font-size: small;">RIESGO DE CORRIENTAZO NO ABRA</p> 	 <p style="text-align: center;"><b>ATTENTION</b></p> <p style="text-align: center; font-size: small;">RISQUE D'ELECTROCUTION NE PAS OUVRIR</p> 									
<p>WARNING: TO REDUCE THE RISK OF FIRE OR ELECTRIC SHOCK, DO NOT EXPOSE THIS APPARATUS TO RAIN OR MOISTURE. TO REDUCE THE RISK OF ELECTRIC SHOCK, DO NOT REMOVE COVER. NO USER-SERVICEABLE PARTS INSIDE. REFER SERVICING TO QUALIFIED SERVICE PERSONNEL.</p>	<p>PRECAUCION: PARA REDUCIR EL RIESGO DE INCENDIOS O DESCARGAS ELECTRICAS, NO PERMITA QUE ESTE APARATO QUEDE EXPUESTO A LA LLUVIA O LA HUMEDAD. PARA DISMINUIR EL RIESGO DE CORRIENTAZO, NO ABRA LA CUBIERTA. NO HAY PIEZAS ADENTRO QUE EL USUARIO PUEDE REPARAR DEJE TODO MANTENIMIENTO A LOS TECNICOS CALIFICADOS.</p>	<p>ATTENTION: PROTEGEZ CET APPAREIL DE LA PLUIE ET DE L'HUMIDITE AFIN D'EVITER TOUT RISQUE D'INCENDIE OU D'ELECTROCUTION. POUR REDUIRE D'ELECTROCUTION NE PAS ENLEVER LE COUVERCLE. AUCUNE PIECE INTERNE N'EST REPARABLE PAR L'UTILISATEUR. POUR TOUTE REPARATION, S'ADRESSER A UN TECHNICIEN QUALIFIE.</p>									
<p><b>IMPORTANT SAFETY INSTRUCTIONS</b></p> <ul style="list-style-type: none"> <li>• READ, FOLLOW, HEED, AND KEEP ALL INSTRUCTIONS AND WARNINGS.</li> <li>• DO NOT OPERATE NEAR ANY HEAT SOURCE AND DO NOT BLOCK ANY VENTILATION OPENINGS ON THIS APPARATUS. FOR PROPER OPERATION, THIS UNIT REQUIRES 3" (75mm) OF WELL VENTILATED SPACE AROUND HEATSINKS AND OTHER AIR FLOW PROVISIONS IN THE CABINET.</li> <li>• DO NOT USE THIS APPARATUS NEAR SPLASHING, FALLING, SPRAYING, OR STANDING LIQUIDS.</li> <li>• CLEAN ONLY WITH LINT-FREE DAMP CLOTH AND DO NOT USE CLEANING AGENTS.</li> <li>• ONLY CONNECT POWER CORD TO A POLARIZED, SAFETY GROUNDED OUTLET WIRED TO CURRENT ELECTRICAL CODES AND COMPATIBLE WITH VOLTAGE, POWER, AND FREQUENCY REQUIREMENTS STATED ON THE REAR PANEL OF THE APPARATUS.</li> <li>• PROTECT THE POWER CORD FROM DAMAGE DUE TO BEING WALKED ON, PINCHED, OR STRAINED.</li> <li>• UNPLUG THE APPARATUS DURING LIGHTNING STORMS OR WHEN UNUSED FOR LONG PERIODS OF TIME.</li> <li>• ONLY USE ATTACHMENTS, ACCESSORIES, STANDS, OR BRACKETS SPECIFIED BY THE MANUFACTURER FOR SAFE OPERATION AND TO AVOID INJURY.</li> <li>• WARNING: TO REDUCE THE RISK OF ELECTRIC SHOCK OR FIRE, DO NOT EXPOSE THIS UNIT TO RAIN OR MOISTURE.</li> <li>• SERVICE MUST BE PERFORMED BY QUALIFIED PERSONNEL.</li> <li>• OUR AMPLIFIERS ARE CAPABLE OF PRODUCING HIGH SOUND PRESSURE LEVELS. CONTINUED EXPOSURE TO HIGH SOUND PRESSURE LEVELS CAN CAUSE PERMANENT HEARING IMPAIRMENT OR LOSS. USER CAUTION IS ADVISED AND EAR PROTECTION IS RECOMMENDED IF UNIT IS OPERATED AT HIGH VOLUME.</li> </ul>											
<table style="width: 100%; border: none;"> <tr> <td style="width: 33%;">EXPLANATION OF GRAPHICAL SYMBOLS:</td> <td style="width: 33%; text-align: center;">  = "DANGEROUS VOLTAGE"  "VOLTAJE PELIGROSO"  "DANGER HAUTE TENSION" </td> <td style="width: 33%; text-align: center;">  = "IT IS NECESSARY FOR THE USER TO REFER TO THE INSTRUCTION MANUAL"  "ES NECESARIO QUE EL USUARIO SE REFIERA AL MANUAL DE INSTRUCCIONES."  "REFERREZ-VOUS AU MANUAL D'UTILISATION" </td> </tr> <tr> <td>EXPLICACION DE SIMBOLOS GRAFICOS:</td> <td></td> <td></td> </tr> <tr> <td>EXPLICATION DES SYMBOLES GRAPHIQUES:</td> <td></td> <td></td> </tr> </table>			EXPLANATION OF GRAPHICAL SYMBOLS:	 = "DANGEROUS VOLTAGE" "VOLTAJE PELIGROSO" "DANGER HAUTE TENSION"	 = "IT IS NECESSARY FOR THE USER TO REFER TO THE INSTRUCTION MANUAL" "ES NECESARIO QUE EL USUARIO SE REFIERA AL MANUAL DE INSTRUCCIONES." "REFERREZ-VOUS AU MANUAL D'UTILISATION"	EXPLICACION DE SIMBOLOS GRAFICOS:			EXPLICATION DES SYMBOLES GRAPHIQUES:		
EXPLANATION OF GRAPHICAL SYMBOLS:	 = "DANGEROUS VOLTAGE" "VOLTAJE PELIGROSO" "DANGER HAUTE TENSION"	 = "IT IS NECESSARY FOR THE USER TO REFER TO THE INSTRUCTION MANUAL" "ES NECESARIO QUE EL USUARIO SE REFIERA AL MANUAL DE INSTRUCCIONES." "REFERREZ-VOUS AU MANUAL D'UTILISATION"									
EXPLICACION DE SIMBOLOS GRAFICOS:											
EXPLICATION DES SYMBOLES GRAPHIQUES:											



### **Congratulations!**

You are now the proud owner of a V-Series V30H Guitar Amplifier Head. This amplifier packs a whole lot of vintage tube sound into its compact cabinet – giving you an amp that’s portable and easy to operate yet still produces incredible sounds! Hidden underneath the amp’s cabinet are a pair of heavy duty slide-out mounting brackets which can be used to “piggy back” the amplifier onto the top of the Crate V212T Guitar Speaker Enclosure - see page 6 for additional information.

Like all St. Louis Music amplifiers, your V30H is designed by musicians, and built using the finest components available. Extensive testing confirms that this amplifier is the absolute best it can be.

In order to get the most out of your new amplifier, we strongly urge you to read the information contained in this manual before you begin playing.

And Thank You for choosing a V-Series amplifier!

## The Front Panel:

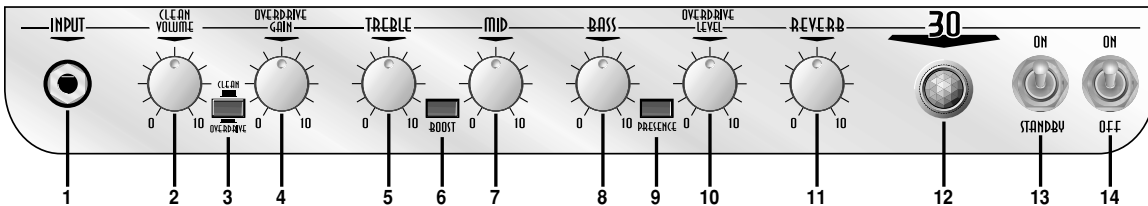

**1. Input:** Connect your instrument here by means of a shielded signal cable.

**2. Clean Volume:** Use this control to adjust the output level of the Clean Channel.

**3. Clean/Overdrive:** This switch, when depressed, selects the Overdrive Channel. When this switch is in the out position, the Clean Channel is selected.

**4. Overdrive Gain:** Use this control to adjust the gain of the Overdrive Channel. With the control towards the counter clockwise position, the gain is low and very little distortion is present. As you rotate the control clockwise the gain increases, producing more overdrive distortion and a higher output volume level.

**5. Treble:** Use this control to adjust the output level of the high frequencies. This control provides 12dB of cut or boost at 6kHz.

**6. Boost:** This switch, when depressed, increases the output by 10dB at 900Hz, giving the middle frequencies more punch.

**7. Mid:** Use this control to adjust the output level of the middle frequencies. This control provides 10dB of cut or boost at 1kHz.

**8. Bass:** Use this control to adjust the output level of the low frequencies. This control provides 8dB of cut or boost at 150Hz.

**9. Presence:** This switch, when depressed, increases the output level of the high frequencies by 8dB at 10kHz, giving a more “glassy” sound to the amplifier. This helps the output of the amplifier cut through “acoustically dead” rooms.

**10. Overdrive Level:** Use this control to adjust the output level of the Overdrive Channel.

**11. Reverb:** Use this control to adjust the amount of reverberation applied to the signal. With the control fully counter clockwise no reverb is applied. As you rotate the control clockwise the amount of reverb increases.

**12. Lamp:** This lamp illuminates when the amplifier is turned on.

**13. On/Standby:** Use this switch to activate the amplifier. The On/Off switch (#14) should be turned on **first**. Allow 20 seconds for the amplifier to warm up before turning the Standby switch on.

**14. On/Off:** Use this switch to turn the amplifier on and off. This switch should be turned on at least 20 seconds **before** turning the Standby switch (#13) on.

**The Rear Panel:**

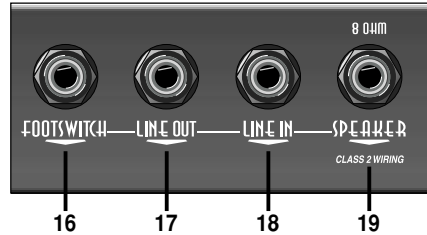

**15. AC Line Cord (not shown):** The grounded power cord should only be plugged into a grounded power outlet that meets all applicable electrical codes and is compatible with the voltage, power, and frequency requirements stated on the rear panel. **Do not attempt to defeat the safety ground connection.**

**16. Footswitch:** Use this jack to connect the supplied two-button footswitch for remote control of channel switching and the Boost function. The front panel Clean/Overdrive and Boost switches (#3,#6) are inoperative when a footswitch is connected.

**17. Line Out:** Use this 1/4" jack to send a line level signal to a mixing board, external power amplifier or powered monitor, or to the input jack of an external signal processor.

**18. Line In:** Use this 1/4" jack to connect the output of an external effects processor to the amplifier.

**19. 8 Ohm Speaker:** Use this jack to connect the external cabinet to the amplifier by means of a heavy duty Class 2 wiring speaker cable terminated with 1/4" plugs. The total impedance rating for the external speaker(s) must be 8 ohms.

**WARNING:** The speaker output of this unit can exceed 10 Watts and could be a shock injury. Connection to speakers should be performed by a skilled person in compliance with local building codes. Class 2 wiring is required for speaker cables. Use of external speakers outside the ratings stated at the speaker jack may result in a shock injury or damage to the unit.

**Piggy Back Mounting onto the V212T Speaker Cabinet:**

The V30H amp head is designed to “piggy back” mount onto Crate’s V212T enclosure. The V30H has slide-out mounting hardware which lock onto the posts on the top of the V212T. Loosen the knobs on the posts, slide the amp in place and lock down the knobs.

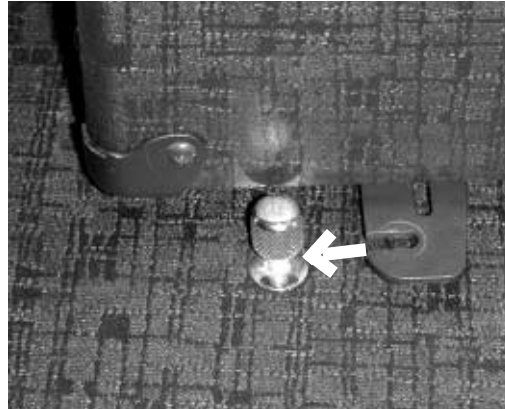

The piggy-backed amp can be rolled around on its casters by the amp head’s handle, but **do not** try to pick the combo up by the amp head or its handle



## **Important Information About Tubes and Tube Products:**

### **A Brief History Of The Tube:**

In 1883, Edison discovered that electrons would flow from a suspended filament when enclosed in an evacuated lamp. Years later, in 1905, Fleming expanded on Edison's discovery and created the "Fleming Valve". Then, in 1907, Dr. Lee de Forest added a third component – the grid – to the "Fleming's Valve" and the vacuum tube was a fact of life. The door to electronic amplification was now open.

During World War II, data gleaned from their intensive research on the detectors used in radar systems led Bell Telephone Laboratories to the invention of the transistor. This reliable little device gained quick support as the new component for amplification. The death of the vacuum tube seemed imminent as designers, scientists, and engineers reveled in the idea of replacing large, fragile glass tubes with these small, solid-state devices.

However, there were (and still are) many serious listeners who realized that the sound produced by a "transistor" amplifier is significantly different from that produced by a tube amplifier with identical design specifications. They considered the sound produced by these new solid-state devices to be hard, brittle, and lifeless. It was determined that solid-state devices produced a less musical set of harmonics than tubes. When pushed past their limits, they tend to mute the tone and emphasize the distortion.

Tubes, on the other hand, produce a more musical set of harmonics, the intensity of which can be controlled by the player. This characteristic adds warmth and definition to the sound which has become the hallmark of tube amplifiers. When tubes are driven into clipping, the harmonic overtones can be both sweet and pleasing or intense and penetrating, depending on the musician's musical taste and playing technique.

Over the years, application engineers have designed a number of outstanding solid-state amplifiers that sound very, very good. Some use special circuitry which enables them to simulate the distortion characteristics of a tube amplifier. However, the tube amplifier, still held in the highest esteem by many musicians, offers a classic "vintage" sound in a contemporary market.

### **Tube Types And Usage:**

Tube amplifiers are based primarily on two types of tubes – preamplifier tubes and power tubes. The tubes used in preamplifiers (12AX7, 12AU7, 12AT7, etc.) are smaller than the power tubes. These tubes amplify the signal from your instrument and shape the sound. They are inherently microphonic (mechanically pick up and transmit external noises). Since these tubes are used in the critical first stages of a tube amplifier's circuitry, it is very important to use high-quality, low noise/low microphonic tubes for this application. Although tubes of this quality may be difficult to find and typically cost more than "off-the-shelf" tubes, the improvement in performance is worth the investment.

Preamplifier tubes are also used to drive the power tubes. When used in this application, a 12AX7 will produce a more distorted tone than a 12AT7, which produces a clearer, sweeter sound. A 12AU7 is even cleaner and brighter than a 12AT7, giving more definition to the sound. (In some cases it is possible to change the sound by changing the type of preamp and/or driver tubes. When making any modification to your equipment, it is highly recommended that you consult with a qualified service center.)

The power tubes are the largest tubes used in an amplifier. These tubes convert the low-level, conditioned signal from the preamplifier into a level that is sufficient to drive the speakers. There are several types of power tubes available, each of which offers a different performance/sound characteristic. For example, the EL34 power tube produces a great Classic rock sound. When an EL34 is driven into distortion it produces a unique sound ("crunch"). When compared to the EL84 and 6L6, the EL34 distorts more quickly, exhibits a

### **Important Information About Tubes and Tube Products (continued):**

"looser" low-end response and produces more harmonics at mid and high frequencies ("creamier" sound). These differences become more noticeable at higher volumes.

The EL84 and 6L6 tubes produce a big low-end thump and have a very good dynamic range. They offer a more traditional "American Rock" sound. The EL84 and 6V6 tubes produce a creamy sound with nice distortion. On the other hand, the KT88 produces a big low-end but sounds more like an EL34 in the mid and high frequencies.

The 6550 power tubes are more rugged and stay cleaner sounding even at full power. When they do distort, the sound produced is more solid and has a tighter low end; more of a "heavy metal" type distortion with lots of power.

Some tubes are available in matched sets. These tubes have been extensively tested for optimum performance and longevity.

### **The Nature Of Tubes: Why (And When) To Replace Them:**

Tubes are made up of a number of fragile mechanical components that are vacuum-sealed in a glass envelope or bubble. The tube's longevity is based on a number of factors which include how hard and often the amplifier is played, vibration from the speakers, road travel, repeated set up and tear down, etc.

Any time you notice a change in your amplifier's performance, check the tubes first.

If it's been a while since the tubes were replaced and the sound from your amplifier lacks punch, fades in and out, loses highs or lows or produces unusual sounds, the power tubes probably need to be replaced. If your amplifier squeals, makes noise, loses gain, starts to hum, lacks "sensitivity", or feels as if it is working against you, the preamplifier tubes may need to be replaced.

The power tubes are subjected to considerably more stress than the preamplifier tubes. Consequently, they almost always fail/degrade first. If deteriorating power tubes aren't replaced they will ultimately fail.

Depending on the failure mode, they may even cause severe damage to the audio output transformer and/or other components in the amplifier. Replacing the tubes before they fail completely has the potential to save you time, money and unwanted trouble. Since power tubes work together in an amplifier, it is crucial that they (if there is more than one) be replaced by a matched set. If you're on the road a lot, we recommend that you carry a spare matched set of replacement power tubes and their associated driver tubes.

After turning off the power and disconnecting the amplifier from the power source, carefully check the tubes (in bright light) for cracks or white spots inside the glass or any other apparent damage. Then, with the power on, view the tubes in a dark room. Look for preamplifier tubes that do not glow at all or power tubes that glow excessively red.

Whenever you replace the power tube(s):

- Always have the amplifier's bias voltage checked by a qualified service center. Improper bias voltage will cause degradation in performance and possibly damage the tubes and/or the amplifier. (See the section below entitled, "The Importance of Proper Biasing", for more information on this subject).
- We highly recommend that you replace the driver tube(s) as well. The driver tube determines the shape and amplitude of the signal applied to the power tube(s) and has to work almost as hard as the power tube(s).



### **Important Information About Tubes and Tube Products (continued):**

You can check your preamplifier tubes for microphonics by turning the amplifier on, turning up the gain and tapping lightly on each tube with the end of a pencil or a chop stick (my favorite). You will be able to hear the tapping through your speakers, which is normal. It is not normal for a tube to ring like a bell after it's tapped. If it does ring then it's microphonic and should be replaced. Remember to use only high quality, low microphonic tubes in the preamplifier section.

Even though power tubes are rarely microphonic, you should check them anyway. The power tubes can be checked for microphonics just like pre-amp tubes.

In the case of very high gain amps, you may be able to reduce the amount of noise generated by simply swapping the preamp tubes around.

### **The Importance Of Proper Biasing:**

For the best performance and longest tube life, proper biasing is imperative. Bias is the negative voltage which is applied to the power tube's control grid to set the level of idle current. We cannot over emphasize the difference in warmth of tone and dynamic response that come with proper biasing. If the bias is set too high (overbiased), the sound from the amp will be distorted at all levels. If the bias is set too low, (under biased) the power tubes will run hot (the plates inside the tubes may glow red due to excessive heat) and the sound from the amplifier will lack power and punch. The excessive heat greatly reduces tube life – from a few days to as little as a few hours in extreme cases. Setting the bias on your amp is like setting the idle on your car. If it's too high or hot it's running away with you and if it's too low or cold it will choke when you step on it.

The bias is adjusted at the factory in accordance with the type of power tube(s) installed in your amplifier. It is important to point out that tubes of the same type and specification typically exhibit different performance characteristics. Consequently, whenever power tubes are replaced, the bias voltage must be checked (unless the amplifier is equipped with "self-biasing circuitry") and readjusted to accommodate the operating parameters of the replacement tubes.

Depending on the model and amplifier type, there may be hum balance controls, trim pots, or bias adjustment controls on its rear panel. However, the bias adjustment should be performed only by qualified service personnel with the proper, calibrated test equipment.



### **Important Information About Tubes and Tube Products (continued):**

#### **Survival Tips For Tube Amplifiers:**

To prolong tube life, observe these tips and recommendations:

- Match the impedance of your speaker cabinet(s) to your amplifier. Improper impedance matching will contribute to early tube degradation and may cause premature tube failure.
- Make sure the speaker(s) are properly connected prior to turning on the amplifier.
- After playing the amplifier, allow sufficient time for it to properly cool down prior to moving it. A properly cooled amplifier prolongs tube life due to the internal components being less susceptible to the damage caused by vibration.
- Allow the amplifier to warm up to room temperature before turning it on. The heat generated by the tube elements can crack a cold glass housing.
- Replace the output tube(s) before the performance degrades or the tubes fail completely. Replace the tube(s) on a regular basis (at least once per year or as often as every 4 to 6 months if you play long and hard every day).
- Always have the bias checked after replacing the output tubes (unless the amplifier is equipped with "self-biasing circuitry"). This should be done **ONLY** at a qualified service center. Improper biasing could result in the tubes running too hot, which greatly reduces the life of the tubes – or too cold, which results in distorted sound regardless of level settings. Do not play the amplifier if it exhibits these symptoms – get the bias checked/adjusted immediately to prevent tube failure and/or other damage.
- If the locating notch on the base of a power tube breaks off, replace the tube. This significantly reduces the risk of damaging your amplifier by incorrectly inserting the tube.
- Protect the amplifier from dust and moisture. If liquid gets into the amplifier proper, or if the amplifier is dropped or otherwise mechanically abused, have it checked out at an authorized service center before using it.
- Proper maintenance and cleaning in combination with routine checkups by your authorized service center will insure the best performance and longest life from your amplifier.

***CAUTION: Tube replacement should be performed only by qualified service personnel who are familiar with the dangers of hazardous voltages that are typically present in tube circuitry.***

**System Block Diagram:**

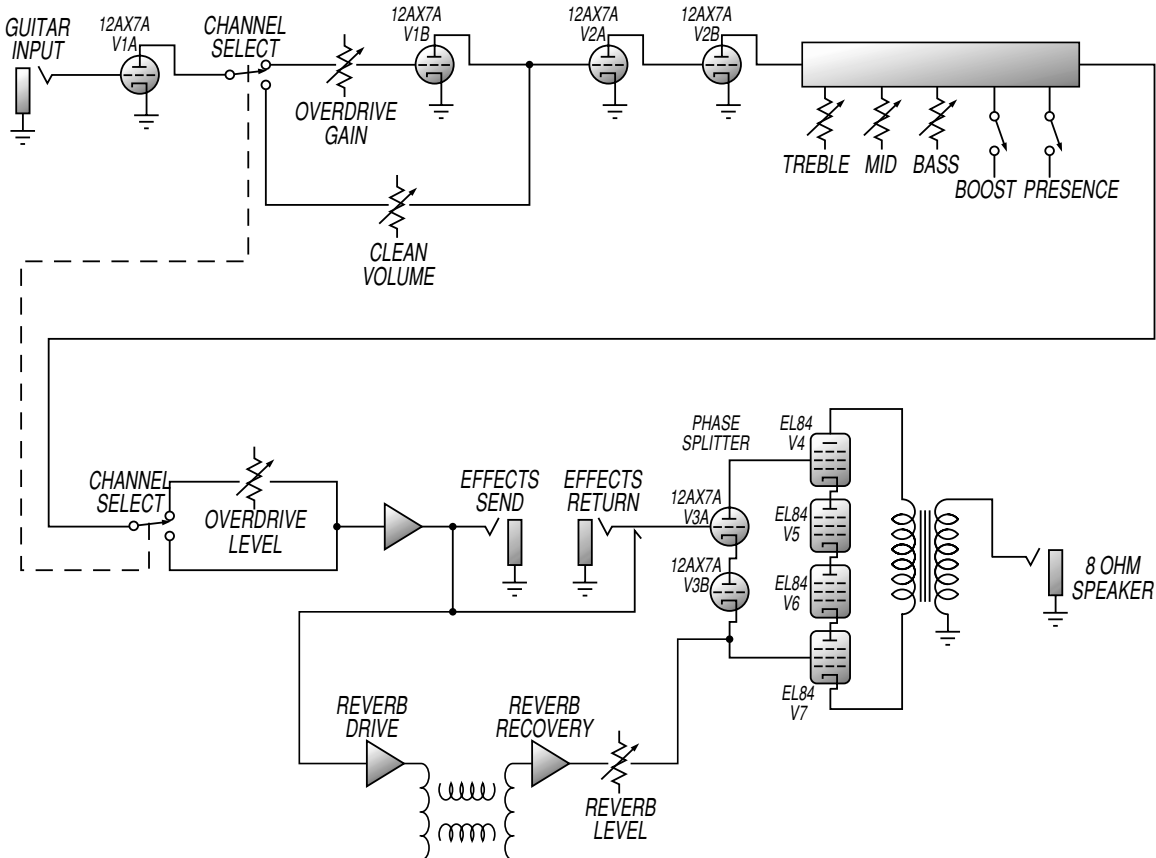

**Declaration of Conformity**

**Manufacturer's Name:** SLM Electronics  
**Corporate Headquarters:** 1901 Congressional Drive, St. Louis, Missouri 63146  
**Primary Production Facility:** 700 Hwy 202 W, Yellville, Arkansas, 72687  
**Product Type:** Audio Amplifier

**Products meet the regulations for compliance marking under:**

- ETL standards UL6500, UL60065, or UL813
- CSA standards E60065 or C22.2 No.1-M90
- CE safety standard EN60065
- CE EMC standards EN55103 or EN55013 and EN61000
- FCC standards 47CFR 15.107 and 15.109 Class A
- C-tick designation Level 2, ABN #56748810738, ARBN# N222
- KETI standard K60065 (limited model approval)

Compliance Support Contact: SLM Electronics, Attn: R&D Compliance Engineer  
 1901 Congressional Drive, St Louis, Missouri, 63146 • Tel.: 314-569-0141, Fax: 314-569-0175

# V SERIES V30H GUITAR AMPLIFIER HEAD

## V30H TECHNICAL SPECIFICATIONS:

<b>OUTPUT POWER RATING</b>	30 Watts RMS @ 6 % THD, 8 ohm load, 120 VAC
<b>SIGNAL TO NOISE RATIO</b>	71dB Typical
<b>GAIN</b>	Clean 56dB, Overdrive 101dB
<b>TREBLE</b>	12dB range @ 6kHz
<b>BOOST</b>	+10db @ 900Hz
<b>MID</b>	10dB range @ 1kHz
<b>BASS</b>	8dB range @ 150Hz
<b>PRESENCE</b>	+8dB @ 10kHz
<b>PREAMP TUBES</b>	(3) 12AX7A
<b>POWER AMP TUBES</b>	(4) EL84
<b>POWER REQUIREMENTS</b>	120 VAC, 60 Hz, 35VA 100/115 VAC, 50/60 Hz, 35VA 230 VAC, 50/60 Hz, 35VA
<b>SIZE AND WEIGHT</b>	21" W x 7-3/4" H x 8-1/8" D, 25.5 lbs.

The V30H is covered with a durable Tolex material: wipe it clean with a lint-free cloth. Never spray cleaning agents onto the cabinet. Avoid abrasive cleansers which would damage the finish.

*Specifications and information in this manual are subject to change without notice.*



[www.v-seriesamps.com](http://www.v-seriesamps.com)

©2004 St. Louis Music, Inc • 1400 Ferguson Avenue • St. Louis, MO 63133  
47-399-01 • 122104