



ICON 600

Use and Installation Instructions

This appliance must be installed in accordance with the regulations in force and only used in a well ventilated space.

Read these instructions before installing or using the appliance and retain them for future use.

Part No. 4866200227-01

CONTENTS

	PAGE
Introduction	3
For Your Safety	4
Oven Timer Operation	6
Hotplate	12
Grill	13
Main Oven	15
Main Oven Cooking Chart	18
The Slow Cook Setting	20
Top Oven	21
Top Oven Cooking Chart	22
Care and Cleaning	24
Something Wrong with your cooker?	27
Installation Instructions	29
Service	Back Cover

INTRODUCTION

To help you make the best use of your cooker, PLEASE READ THIS BOOKLET CAREFULLY.

Your new cooker is guaranteed and will give lasting service. The guarantee is only applicable if the cooker has been installed in accordance with the Installation Instructions.

The cooker is designed specifically for domestic use and responsibility will not be accepted for use in any other installation.

When first using the cooker ensure that the room is well ventilated (e.g. open a window or use an extractor fan) and that persons who may be sensitive to the odour avoid any fumes. It is suggested that any pets be removed from the room until the smell has ceased. This odour is due to any temporary finish and also any moisture absorbed by the insulation.

Our policy is one of continual improvement in design and development, therefore strict accuracy of illustrations and descriptions cannot be guaranteed.



This appliance conforms to the following EEC Directive:

Gas Appliances
90/396/EEC

Low Voltage Equipment
73/23/EEC
93/68/EEC

Electromagnetic Compatibility
89/336/EEC
92/31/EEC
93/68/EEC

FOR YOUR SAFETY

Please read the precautions below before using your cooker.

ALWAYS . . .

- ALWAYS make sure you understand the controls before using the cooker.
- ALWAYS check that all controls on the cooker are turned off after use.
- ALWAYS stand back when opening an oven door to allow heat to disperse.
- ALWAYS use dry, good quality oven gloves when removing items from the ovens.
- ALWAYS take care when removing items from the top oven/grill when the main oven is on, as the contents may be hot.
- ALWAYS keep the oven and grill doors closed when the cooker is not in use.
- ALWAYS place pans centrally over the hotplate burners and position them so that the handles cannot accidentally be caught or knocked or become heated by other burners.
- ALWAYS keep the cooker clean, as a build up of grease or fat from cooking can cause a fire.
- ALWAYS allow the cooker to cool before cleaning.
- ALWAYS follow the basic principles of food handling and hygiene to prevent the possibility of bacterial growth.
- ALWAYS keep ventilation slots clear of obstructions.
- ALWAYS turn off the electricity supply before cleaning or replacing the oven lamp.
- ALWAYS refer servicing to CORGI registered appliance service engineers.

FOR YOUR SAFETY

NEVER...

- NEVER leave children unsupervised where the cooker is installed as all surfaces will get hot during and after use.
- NEVER allow anyone to sit or stand on any part of the cooker.
- NEVER store items that children may attempt to reach above the cooker.
- NEVER heat up unopened food containers as pressure can build up causing the container to burst.
- NEVER store chemicals, food stuffs, pressurised containers in or on the cooker, or in cabinets immediately above or next to the cooker.
- NEVER fill a deep fat frying pan more than 1/3 full of oil, and never use a lid.
DO NOT LEAVE UNATTENDED WHILE COOKING.
- NEVER place flammable or plastic items on or near the hotplate.
- NEVER use proprietary spillage collectors on the hotplate.
- NEVER use the cooker as a room heater.
- NEVER dry clothes or place other items over or near to the hotplate or oven/grill doors.
- NEVER wear garments with long flowing sleeves whilst cooking.

NOTE: The use of a gas cooking appliance results in the production of heat and moisture in the room in which it is installed. Always ensure that the kitchen is well ventilated; keep natural ventilation holes open or install a mechanical ventilation device (mechanical extractor hood).

In particular, when using the grill or more than one hotplate burner, open a window if a mechanical ventilation device is not operating.

OVEN TIMER OPERATION

The oven timer offers you the following features:

1. Time of Day
2. Automatic Cooking
3. Minute Minder

AUTOMATIC COOKING

The main oven can be controlled automatically.

GUIDANCE ON AUTOMATIC COOKING

1. Select foods which will take the same time to cook.
2. Set the oven timer so that the food has just finished or is just about to finish cooking on your return to the oven. This will ensure the food has not cooled down and does not require reheating before serving.
3. Food should be as cold as possible when it goes into the oven, ideally straight from the refrigerator. Frozen meat and poultry should be thawed thoroughly before it is put in the oven.
4. We advise that warm food should never be placed in the oven if there is to be a delay period. Stews prepared by frying the meat and vegetables should be cooked as soon as possible.
5. We advise dishes containing left-over cooked poultry or meat, for example Shepherds Pie, should not be cooked automatically if there is to be a delay period.
6. Stews and joints should be cooked by the long slow method, so that the delay period is kept to a minimum.
7. On warm days, to prevent harmful bacterial growth in certain foods (ie poultry, joints, etc) the delayed start should be kept to a minimum.
8. Wine or beer may ferment and cream may curdle during the delay period, so it is best to add these ingredients just before serving.
9. Foods which discolour should be protected by coating in fat or tossing in water to which lemon juice has been added, prior to placing food in the oven.
10. Dishes containing liquid should not be filled too full to prevent boiling over.
11. Food should be well sealed (but not airtight) in a container to prevent the loss of liquid during cooking. Aluminium foil gives a good seal.
12. Ensure food is cooked thoroughly before serving.

TIMER OPERATION

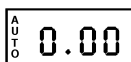

CLOCKFACE

The timer incorporates a 24 hour clock.

Ensure the correct time of day is always set, before using your cooker.

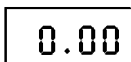

SYMBOLS

A 'bell' symbol will light up when you select a Minute Minder Period and will remain lit for the period set.

At the end of the Minute Minder Period, the timer will emit an audible tone and the 'bell' symbol will disappear.

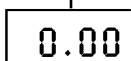

The 'cookpot' symbol will light up either:-

- When the timer is in manual mode, or
- During the actual Cook Period.

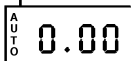

'AUTO' will light up:-

- When the timer is first turned on it will flash. It will go out when a time of day is set or when the timer is set to manual.

The 'AUTO' symbol will flash at the end of an Auto Cooking programme to indicate that the programme has finished.

(When the 'AUTO' symbol is flashing, to return the oven to Manual operation, turn the oven controls off, ensure that the correct time of day is set, and press the "Manual" button - The 'AUTO' symbol will go out.)



TIMER FUNCTION BUTTONS



Minute Minder Button

Here you can set a time period of up to 23 hours 59 minutes, that will count down. When it reaches zero, the timer will emit an audible tone.

For Example: If you set 20 minutes, the audible tone will occur 20 minutes later.

AUTO COOKING PROGRAMME



Cook Period Button

Cook Period is the actual length of time for which, the timer will switch the oven(s) on as part of an "Auto Cooking" programme.

(e.g. If you set 2 hours, the food will be cooked for 2 hours).



End Time Button

The time of day at which you want an "Auto Cooking" programme to **end**.

For Example: If you set a "Cook Period" for 2 hours, and "End Time" of 11:00. The timer will switch the oven(s) on at 9:00 and turn the oven(s) off at 11:00. You will hear a audible tone at 11:00, to indicate that the Auto Cooking Programme has finished.

Notes:

- When setting an Auto Cooking programme you will need to set the oven control(s) to the required temperature(s) when you set the timer.
- If an Auto Cooking programme has been set the oven(s) will only operate during the pre-programmed time.



Manual Button

Needs to be pressed to cancel an Auto Cooking programme and return the oven(s) to Manual operation.

"+" and "-" Buttons Used to adjust the various timer function settings.

TIMER OPERATION

SETTING THE TIME OF DAY

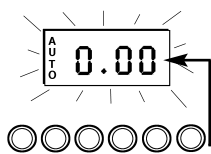

Step 1 Make sure all oven controls are turned Off.

Step 2 Check the electricity supply to the cooker is turned on.

Step 3 When switched on the display will show 0.00 and the Auto symbol, flashing intermittently.

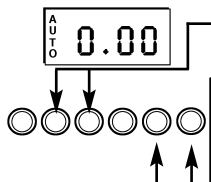

Step 4 Press & hold in both the Cook Period & End Time buttons together.

Step 5 With the Cook Period & End Time buttons still held in, press either the "+" or "-" buttons to set the correct time of day.

Step 6 Release all the buttons simultaneously.

THE TIME OF DAY IS NOW SET.

To change the time of day repeat Steps 4, 5 & 6 above.

Note: You cannot adjust the time of day if the timer has been set for an Auto Cooking Programme.

SETTING THE MINUTE MINDER

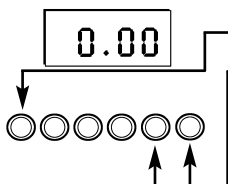

Step 1 Ensure the time of day is set correctly.

Step 2 Press and hold the Minute Minder button.

Step 3 With the Minute Minder button held in, set the required Minute Minder period using the "+" and "-" buttons. A 'bell' symbol will light up.

Release all buttons and the timer display will revert back to the time of day. The 'bell' symbol will remain lit to signify that a Minute Minder period has been set.

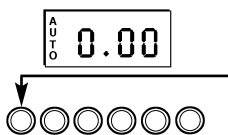

At the end of the set time an audible tone will be heard, and the 'bell' symbol will disappear.

Step 4 To cancel the audible tone press the Minute Minder button.

Note 1 When the Minute Minder has been set, the time remaining can be checked at any time by simply pressing the Minute Minder button.

Note 2 If necessary the Minute Minder can be cancelled before the tone sounds by pressing and holding the Minute Minder button and then at the same time pressing the "-" button until 0.00 appears in the display window.

TIMER OPERATION

AUTO COOKING PROGRAMMES

There are two Auto Cooking programmes that can be selected using your timer:-

- (a) To set the timer to switch the oven(s) On and Off Automatically
- (b) To set timer to switch on immediately and OFF automatically after a set cook period.

a) TO SET THE TIMER TO SWITCH THE OVEN(S) ON AND OFF AUTOMATICALLY

This allows you to cook at a specified time for a chosen period before the oven switches off Automatically.

- Step 1** Check that the correct time of day is set, if not follow instructions for setting the time of day.
- Step 2** Place food onto the correct shelf position in the oven and close the oven door(s).

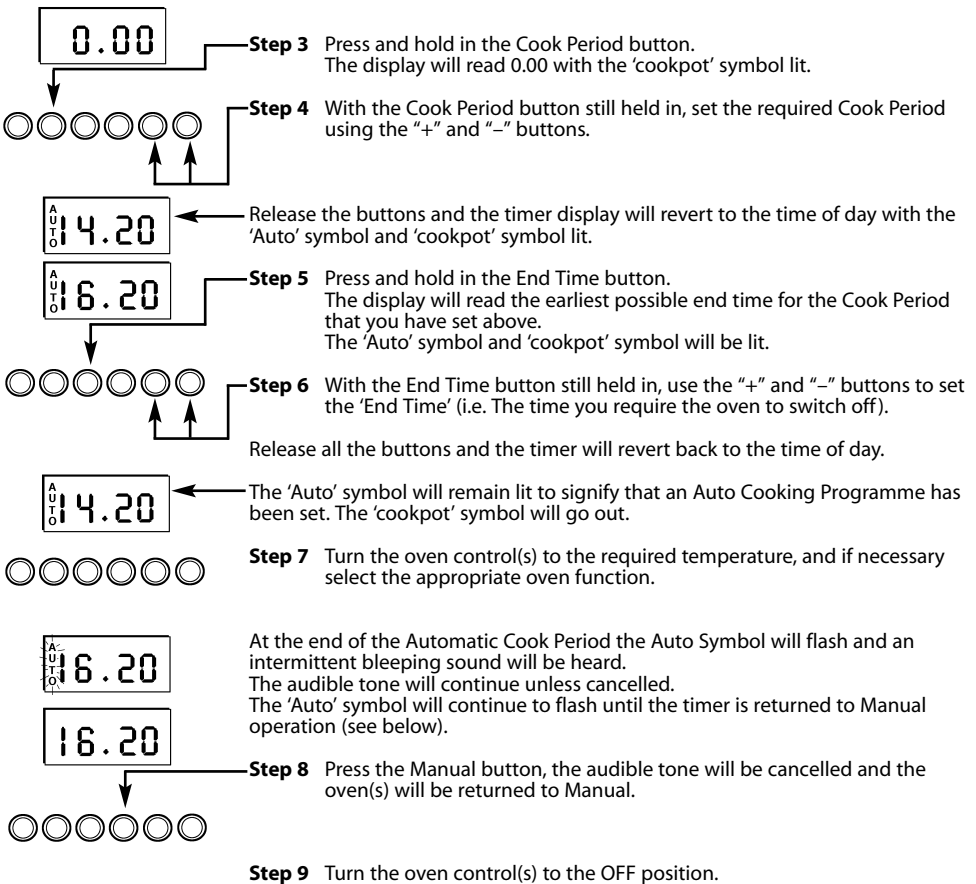

TIMER OPERATION

Note 1 When cooking automatically the Cook Period can be checked at any time by simply pressing the Cook Period button.

Note 2 When cooking automatically the End Time can be checked at any time by simply pressing the End Time button.

b) TO SET TIMER TO SWITCH ON IMMEDIATELY AND OFF AUTOMATICALLY AFTER A SET COOK PERIOD

- Step 1** Check that the correct time of day is set, if not follow instructions for setting the time of day.
Step 2 Place food onto the correct shelf position in the oven and close the oven door(s).
Step 3 Turn the oven control(s) to the required temperature, and if necessary select the appropriate oven function.

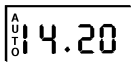
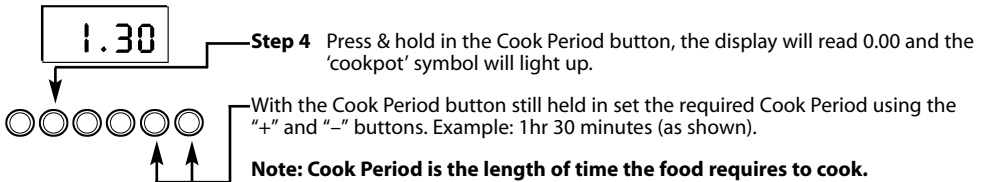

Step 5 Release all buttons.

The timer display will revert to the time of day with the 'Auto' symbol lit & 'cookpot' symbol remaining lit.

NOTE: The Cookpot symbol disappears

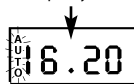

At the end of the Cook Period the 'Auto' symbol will flash and an intermittent audible tone will be heard. The audible tone will continue until cancelled. The 'Auto' symbol will continue to flash until the timer is returned to Manual operation (see below).

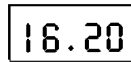

Step 6 Press the Manual button. The audible tone will be cancelled and the oven(s) will be returned to Manual.



Step 7 Turn the oven control(s) to the OFF position.

TIMER OPERATION

TO CANCEL AN AUTO COOKING PROGRAMME BEFORE THE COOK PERIOD HAS FINISHED.

Step 1 Turn the oven control(s) to the OFF position.

15.00

Step 2 Press the Manual button to return the oven(s) to "Manual" operation. The 'Auto' symbol will go out.



Note 1 When cooking automatically the Cook Period can be checked at any time by simply pressing the Cook Period button.

OTHER NOTES ON TIMER OPERATION

1. When cooking Automatically the Cook Period can be checked at any time simply by pressing the Cook Period button.
2. When cooking Automatically the End Time can be checked at any time by simply pressing the End Time button.
3. Having set a Cook Period and End Time an electronic device stores the information. The device within the timer will switch the oven(s) on and off at the required times.
4. When setting an Auto Cooking Programme and a mistake is made, to clear:-
 - (a) Press & release the Manual button.
 - (b) Start the sequence again.
5. If at any time the display shows three flashing zero's 0.00 and 'Auto', it is likely that the electricity supply to the oven has been interrupted. Reset the timer to the correct time of day.
Food in the oven may, therefore, not have been cooked, before serving check food is thoroughly heated and completely cooked.
6. To set each function always press and hold the required function button and at the same time press "+" or "-" buttons.

HOTPLATE

The hotplate has one very high speed wok burner, one high speed burner and two simmering burners which will accommodate pans between 100mm (4") and 230mm (9") diameter. All pans should be positioned centrally over the burners.

TO USE THE HOTPLATE

1. Press the ignition button and then push in and turn the control knob of the chosen burner anti-clockwise to the large flame symbol. Continue to press the ignition button until the sparks light the gas.
2. Turn the control knob anti-clockwise to the desired setting.
Only turn the control knob between the large flame symbol and the small flame symbol for adjusting the setting.
3. To turn off, turn the control knob fully clockwise to the symbol **O**.

DO NOT use the hotplate unless all pan supports are in position.

DO NOT use mis-shapen pans which may be unstable.

DO NOT use round base woks directly on the pan supports.

Each burner is fitted with a spark ignitor for lighting the gas. To ensure rapid lighting of the burners every time they are used, the ignitors must be kept **clean and dry**. Remove any food spillage or cleaning materials from the ignitor using a small nylon brush such as a tooth brush. Access to the ignitor can be achieved by lifting off the loose burner parts carefully when the burners are cool.

When the hotplate burner bodies and caps are removed for cleaning, be careful not to drop any food particles or cleaning materials into the burner bases, to avoid the possibility of blocking the gas jets.

If aluminium based pans are used, a silvery deposit may appear on the top edge of the pan support fingers. See 'Care and Cleaning' section for cleaning information.

When the hotplate burners are turned down, a slight 'popping' noise may be heard. This is perfectly normal.

SAFETY REQUIREMENTS FOR DEEP FAT FRYING

1. Never fill chip pans more than one third full with oil or fat.
2. Never leave oil or fat unattended during the heating or cooling period.
3. Never heat fat or fry with a lid on the pan.
4. Always dry food thoroughly before frying, and lower it slowly into the hot oil or fat. Frozen foods in particular will cause frothing and spitting if added too quickly.
5. Always keep the outside of the pan clean and free from streaks of oil or fat.

HOW TO DEAL WITH A FAT FIRE

1. Do not move the pan.
2. Turn off the hotplate burners.
3. Smother the flames with a fire blanket or damp cloth to extinguish the fire. Do not use water or a fire extinguisher as the force of it may spread the burning fat or oil over the edge of the pan.
4. Leave the pan for at least 60 minutes before moving it.

GRILL

CAUTION – ACCESSIBLE PARTS MAY BECOME HOT WHEN THE GRILL IS IN USE. YOUNG CHILDREN SHOULD BE KEPT AWAY.

GRILL PAN HANDLE

The grill pan handle is detachable from the pan to facilitate cleaning. The handle can be either detachable from or fixed to the pan.

Remove the screw and washer from the grill pan bracket, tilt the handle over the recess adjacent to the bracket (A). Slide the handle towards the centre of the pan (B) and let the handle locate over the bracket (C).

For a detachable handle: Remove the screw and washer from the grill pan and keep safe.

For a fixed handle: Replace the screw and washer and ensure they are fully tightened.

Warning: Ensure when using grill pan handle in the detachable manner it is centralised and secure.

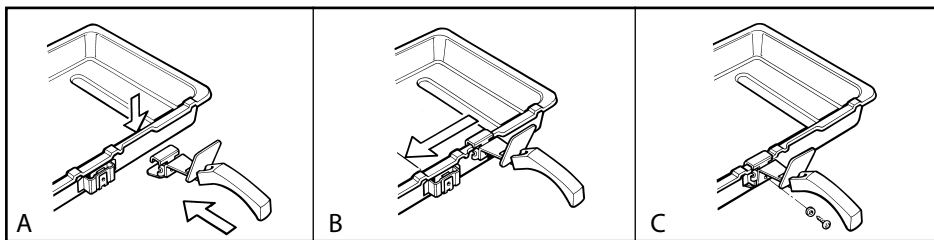

TO USE THE GRILL

1. Check that the electricity supply is switched on.
2. Open the top oven/grill door and remove the grill pan.
3. Remove the heat shield from the rear of the shelf for maximum grilling area.
4. Place shelf in chosen position. Refer to grilling chart.
5. Press the ignition button and then push in and turn the control knob clockwise to the large flame symbol. Continue to press the ignition button until the sparks light the gas.
6. Slide the grill pan along the shelf towards the rear of the grill compartment until it stops.
7. Turn the control knob to the desired setting. Only turn the control knob between the large flame symbol and the small flame symbol when adjusting the setting.
8. To turn off, turn the control knob anti-clockwise to the symbol **O**.

The grill cannot be used at the same time as the top oven.

An odour may be noticed when first using the grill – this should cease after a short period of use.

DO NOT use the grill with the door closed.

DO NOT cover the grill pan or grid with aluminium foil as this can hold fat, intensify the heat and create a fire hazard.

RELIGHTING THE BURNER

In the event of the burner flames being accidentally extinguished, turn off the burner control and do not attempt to re-ignite the burner for at least one minute.

GRILL

The following chart is a guide. Grilling can be started from cold but for best results preheat for approximately two minutes. Most cooking is done with the heat on full, but it may be desirable to reduce it for thicker pieces of meat or for keeping food warm.

Shelf Position	Food
HIGH POSITION	Toast, pikelets/crumpets, bacon, thin sausages, beefburgers, tomato halves, steak (rare and medium), kippers, gammon, kidneys and toasted snacks.
CENTRE POSITION	Toast, toasted snacks, thick sausages, beefburgers, fish fingers, steak (well done) and gammon, chops (with heat turned down for part of cooking time).
LOW POSITION	Whole fish, fish fillets and fish steaks (on base of pan). Chicken portions (with heat turned down for part of cooking time).

For au gratin dishes eg. Macaroni Cheese and meringue toppings eg. Baked Alaska, place the dish on the floor of the grill compartment. The base of the grill pan can be used for warming fruit garnishes on the reduced setting.

REMOVE HEAT SHIELD FROM SHELF WHEN GRILLING FOR MAXIMUM GRILLING AREA

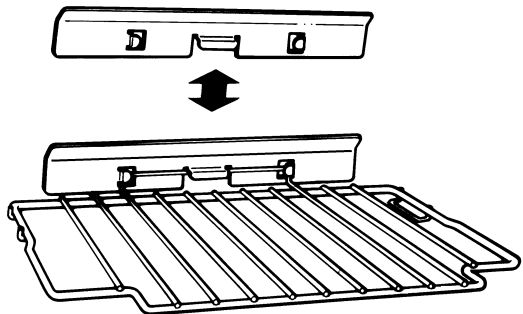

NOTE: Strong detergents used in dishwashers may damage the grill pan grid finish; clean in soapy water as described in CARE AND CLEANING section.

Always ensure that the grill pan handle is correctly fitted to the grill pan. If necessary tighten any loose screws with a screwdriver.

MAIN OVEN

The main oven can be used in two different modes. The choice of mode is selected by the “Fan Select” button on the fascia, pressing **in** for **fan mode**.

CONVENTIONAL (NON FAN) MODE

A conventional gas oven has different heat zones. The thermostat settings refer to the temperature on the middle shelf; above this shelf is hotter and below it is cooler. The conventional mode allows you to cook different foods requiring different cooking temperatures at the same time, for instance, cooking full meals using three shelf positions for three different dishes.

FAN MODE

A fan oven circulates hot air around the oven providing an even temperature on all the shelf positions. In the fan oven mode, cooking times are reduced and at the same mark setting, temperatures are lower. The fan mode allows you to make full use of the oven, for instance batch baking on all three shelves.

OVEN SHELVES

Two straight shelves and one cranked shelf provide ten possible cooking levels. Each shelf has a safety stop to prevent it from being pulled out too far when attending to food. Shelves are removed from the oven by pulling them out to the stop and then lifting them at the front to withdraw.

A heat shield is provided for one oven shelf and should always be fitted when the shelf is used in the lower two positions. This shield can be removed for cleaning.

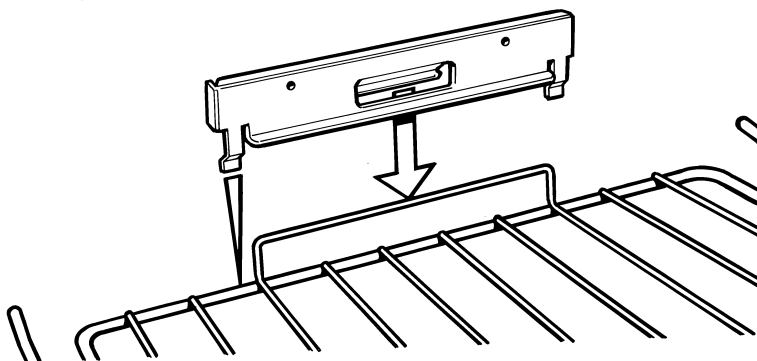

The baking dish and grill pan without the handle can be used in the oven. The maximum size of baking tray that should be used is 300mm x 350mm (12" x 14").

MAIN OVEN

TO USE THE MAIN OVEN

1. Check that the electricity supply is switched on and the timer is set to manual mode.
2. Place oven shelves in the chosen positions. (refer to cooking charts).
3. Select the oven mode with the "Fan Select" button on the fascia:
(in) for fan mode OR (out) for conventional mode.
4. Push in and turn oven control knob fully anti-clockwise. Sparking will continue until the burner has lit.
5. Turn the control knob clockwise to the required setting. (refer to cooking chart). There is a delay of about one minute whilst the safety device operates before the burner comes on full.
6. To turn off, turn the control knob fully clockwise to the symbol **O**.

Never place dishes on the oven base over the burner.

An odour may be noticed when first using the oven – this should cease after a short period of use.

Guidance on using the fan mode

Ensure that when selecting shelf positions, you leave enough space around the food to allow air to circulate. For best results use the following guide:-

One shelf – any shelf position.

Two shelves – straight shelves in positions 2 and 4.

Three shelves – cranked shelf in position 1, straight shelves in positions 3 and 5.

Shelf position 1 is at the top and shelf position 5 is at the bottom.

Always use the shelf shield when using shelf positions 4 or 5.

Guidance on using the conventional mode

Follow the information in the cooking chart for the best shelf positions. When baking two trays on different levels, the top tray is removed first and then the lower tray is moved to the top position for a few minutes longer.

MAIN OVEN

COLD START COOKING

Anything requiring long slow cooking such as casseroles and rich fruit cakes can be put into a cold oven. Satisfactory results can also be obtained with creamed mixture, rich pastries or yeast mixtures, but for perfection we recommend preheating the oven for about 15 minutes at the gas mark you require for cooking.

ROASTING OF LARGE POULTRY

The maximum weight of poultry that can be accommodated is 11.5kg (25 lbs) of suitable shape.

It is important to check that the bird DOES NOT overhang the burner at the back of the oven.

STORAGE AND RE-HEATING OF FOOD

It is vitally important to strictly adhere to the basic principles of food handling and hygiene to prevent the possibility of bacterial growth.

1. If food is to be frozen or not served immediately, cool it in a clean container as quickly as possible.
2. Completely thaw frozen food in the refrigerator before re-heating.
3. Re-heat food thoroughly and quickly either on the hotplate or in a hot oven, Mk. 6, and then serve immediately.
4. Only re-heat food once.

'COOK CHILL' DISHES

These should always be placed in a pre-heated oven ideally on the first or second shelf position. Follow the packet instructions for cooking time.

ALUMINIUM FOIL

If using Aluminium Foil:

1. Remember that it is important to increase the cooking time by one third.
2. Never allow the foil to touch the sides of the oven.
3. Never cover the oven interior with foil.
4. Never cover the oven shelves with foil.

MAIN OVEN COOKING CHART

The following times are for guidance only. You may wish to alter the setting to give a result more to your satisfaction. When a different setting is given in a recipe, the recipe instruction should be followed. Cooking times for the conventional oven are based on a 15 minute preheat. Always turn the thermostat to mark 9 before turning back to the required gas mark. Shelf position 1 is at the top and shelf position 5 is at the bottom.

Food	Gas Mark	FAN OVEN	CONVENTIONAL OVEN	
		Approximate Cooking Time	Shelf Position	Approximate Cooking Time
STARTERS				
Patés & Terrines	3 or 4	1½ – 2 hrs.	4	1½ – 2 hrs.
FISH				
Oily fish (whole)	4 or 5	20 – 50 mins. depending on size and recipe	3	25 mins. – 1 hr. depending on size and recipe
White fish (fillets and steaks)	4 or 5	25 – 30 mins.	3	25 – 30 mins.
MEAT AND POULTRY				
Veal	5	25 mins. per 450g (1lb) + 20 mins.	4	25 mins. per 450g (1lb) + 25 mins.
Beef	4 or 5	20 – 25 mins. per 450g (1lb) + 20 mins.	4	25 – 30 mins. 450g (1lb) + 25 mins.
Ham	5	35 mins. per 450g (1lb) covered in foil + 35 mins. uncovered	4	40 mins. per 450g (1lb) covered in foil + 40 mins. uncovered
Lamb	5	25-30 mins. per 450g (1lb) + 25 mins.	4	30-35 mins. per 450g (1lb) + 30 mins.
Pork	5	35 mins. per 450g (1lb) + 35 mins.	4	40 mins. per 450g (1lb) + 40 mins.
Chicken	5	20 – 25 mins. per 450g (1lb) + 20 mins.	4	25 mins. per 450g (1lb) + 25 mins.
Duckling & Gosling	5	20 – 25 mins. per 450g (1lb) + 20 mins.	4	25 mins. per 450g (1lb) + 25 mins.
Turkey	4 or 5	15 – 20 mins. per 450g (1lb) + 20 mins.	4 or 5	15 – 20 mins. per 450g (1lb) + 25 mins.
Game Birds	6	40-50 mins. Remove bacon for last 15 mins. Add extra 15 mins. if roasting a brace.	4	50 mins. Remove bacon for last 15 mins. Add extra 15 mins. if roasting a brace.
Casseroles	3	1½ – 6 hrs. (depending on type of meat)	3 or 4	1½ – 6 hrs. (depending on type of meat)
PUDDINGS				
Milk puddings	3	2 – 2¼ hrs. on a baking tray and started with warm milk	3 or 4	2¼ – 2½ hrs. stand dish on a baking tray and start with warm milk
Baked custard	3	40 mins. in bain-marie	3 or 4	45 mins. in bain-marie
Baked sponges	4	35 – 45 mins.	3	40 – 50 mins.
Baked apples	3	25 – 40 mins. depending on size and type of apples	4	30 – 45 mins. depending on size and type of apples
Meringue puddings	1	15 mins. or until 'tinged' with brown	4 or 5	15 mins. or until 'tinged' with brown
Apple pie or tart 230mm (9")	6	40 – 50 mins.	3	45 – 55 mins. stand dish on a baking tray
Fruit crumbles	5 or 6	30 – 40 mins.	3	35 – 45 mins.

MAIN OVEN COOKING CHART

NOTE: If soft tub margarine is used for cake making, temperatures recommended by the manufacturers should be used. The settings recommended in this chart refer to cakes made with block margarine or butter only.

Food	Gas Mark	FAN OVEN	CONVENTIONAL OVEN	
		Approximate Cooking Time	Shelf Position	Approximate Cooking Time
CAKES, PASTRIES & BISCUITS				
Small cakes	5	20 – 25 mins.	2 & 4	17 – 25 mins.
Victoria sandwich 205mm (8")	4	20 – 30 mins.	2 & 4	25 – 35 mins.
Fatless sponge 180mm (7")	5	(preheat oven first) 20-25 mins. (2 tins side by side)	2	20 – 25 mins. (2 tins side by side)
Christmas Cake	2	3 – 6 hrs. depending on recipe	3 or 4	4 – 6½ hrs. depending on recipe
Madeira cake 180mm (7")	4	1 – 1¼ hrs.	3	1¼ – 1½ hrs.
Rich fruit cake 230mm (9")	2	2½ – 3 hrs. depending on size	3	3 – 3½ hrs.
Shortcrust pastry	6	15 – 45 mins. depending on recipe	2 or 3	15 mins. – 1 hr. depending on recipe
Rich Shortcrust pastry	5	20– 40 mins. depending on recipe	2	20– 40 mins. depending on recipe
Flaky & puff pastry	7	(Preheat oven first) 10 – 30 mins. depending on recipe	1 & 3	10 – 30 mins. depending on recipe
Choux pastry – éclairs	6	(Preheat oven first) 30 – 40 mins.	2	35 – 40 mins.
Scones	7	(Preheat oven first) 10 – 15 mins.	2 & 4	10 – 15 mins.
Shortbread	2	50 mins. – 1 hr. depending on thickness	4	55 mins. – 1 hr. depending on thickness
Biscuits	4	15 – 20 mins. depending on recipe	1 & 3	15 – 20 mins. depending on recipe
YEAST MIXTURES				
Bread	7 or 8	(Preheat oven first) 40 – 45 mins.	3 or 4	45 – 50 mins.
Rolls	7 or 8	(Preheat oven first) 15 – 20 mins.	2 or 3	15 – 20 mins.
Chelsea buns	5	(Preheat oven first) 20 – 30 mins.	2 or 3	30 – 40 mins.
MISCELLANEOUS				
Yorkshire pudding – large	7	(Preheat oven first) 40 – 45 mins.	1 or 2	45 – 50 mins.
Yorkshire pudding – individual	7	(Preheat oven first) 15 – 25 mins.	1 or 2	25 – 30 mins.
Soufflés	4	(Preheat oven first) 25 – 30 mins.	3	30 mins.
Meringues	Slow Cook	2 – 5 hrs.	4 & base	2 – 5 hrs. starting on shelf 4 then on base until dried out – turn when necessary.
Baked Potatoes	4 or 5	1½ – 3 hrs. until soft, depending on size.	3	1½ – 3 hrs. until soft, depending on size.

THE 'SLOW COOK' SETTING

The 'Slow Cook' setting on the main oven thermostat is used for slow cooking **in conventional mode only**, keeping food warm and warming plates for short periods.

USING THE 'SLOW COOK' SETTING FOR SLOW COOKING

1. All dishes cooked by the 'Slow Cook' setting should be cooked for a minimum 6 hours. They will 'hold' at this setting for a further hour but marked deterioration in appearance will be noticed in some cases.
2. Joints of meat and poultry should be cooked at Mk. 6 for 30 minutes before turning to the 'Slow Cook' setting and never be cooked lower than the middle shelf position.
3. Joints of meat over 6 lbs (2.7kg) and poultry over 4 lbs 8oz (2 kg) should not be cooked using the 'Slow Cook' setting.
4. Always stand covered joints on a rack over the meat tin to allow good air circulation.
5. A meat thermometer should be used when cooking pork joints and poultry. The internal temperature of the food should reach at least 88°C.
6. This method is unsuitable for stuffed meat and stuffed poultry.
7. Always bring soups, casseroles and liquids to the boil before putting in the oven.
8. Cover casseroles with foil and then the lid to prevent loss of moisture.
9. Always thaw frozen food completely before cooking.
10. Root vegetables will cook better if cut into small pieces.
11. Adjust seasonings and thickenings at the end of the cooking time.
12. Use the zones of heat in the oven, e.g. meringues and milk puddings can be cooked lower in the oven whilst other dishes requiring greater heat can be cooked above them.
13. Egg and fish dishes need only 1-5 hours cooking and should be included in day cooking sessions, when they can be observed from time to time.
14. Dried red kidney beans must be boiled for a minimum of ten minutes after soaking, before inclusion in any dish.

TOP OVEN

The top oven can be used to cook small quantities of food or used in conjunction with the main oven to provide additional cooking space.

The shelf in the top oven has a heat shield fitted at the rear. The shield can be removed for cleaning and grilling, but must be replaced when using the oven. The shelf can be used in three different positions. It has a safety stop to prevent it from being pulled out too far when attending to food. The shelf is removed from the oven by pulling it out to the stop and then lifting at the front to withdraw.

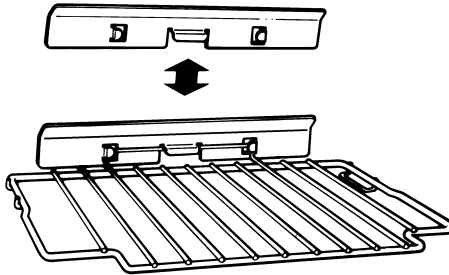

The baking dish and grill pan without the handle can be used in the oven. The maximum size of baking tray that should be used is 300mm x 350mm (12" x 14").

TO USE THE TOP OVEN

1. Check that the heat shield is fitted to the shelf.
2. Place the top oven shelf in the chosen position. (refer to cooking chart).
3. Push in and turn the top oven/grill control knob fully anti-clockwise. Sparking will continue until the burner has lit.
4. Turn the control knob clockwise to the required setting. (refer to cooking chart).
5. There is a delay of about one minute whilst the safety device operates before the burner comes on full.
6. To turn off, turn the control knob clockwise to the symbol **O**.

GUIDANCE ON USING THE TOP OVEN

1. Best results are obtained by pre-heating the oven for about 15 minutes.
2. The tray or dish on which the food is to be cooked, should be pushed to the back of the shelf.
3. Food which is higher than or will rise above 125mm (5") cannot be cooked in the top oven.

Never place dishes on the oven base over the burner.

An odour may be noticed when first using the oven – this should cease after a short period of use.

TOP OVEN COOKING CHART

The following times and setting are for guidance only. You may wish to alter the setting to give a result more to your satisfaction. When a different setting to that shown below is given in a recipe, the recipe instructions should be followed. Allow 15 minutes preheat for best results. Always turn the thermostat knob to Mark 8 before selecting the required gas Mark. Shelf position 1 is the highest.

Food	Gas Mark	Shelf Position	Approx. Cooking Time and Comments
FISH		Push dish right to back of shelf.	
Oily and white fish	5	2	20-30 mins.
MEAT AND POULTRY			
Beef (medium)	4 or 5	3	25-30 mins per lb + 25-30 mins
Ham (covered in foil)	5	3	40 mins per lb + 40 mins
Lamb	5	3	30-35 mins per lb + 30 mins
Pork	5	3	40 mins per lb + 40 mins
Chicken	5	3	25 mins per lb + 25 mins
Duckling & Goose	5	3	25 mins per lb + 25 mins
Turkey	4	3	15-20 mins per lb + 15-20 mins
Casseroles	3	3	2-4 hrs. depending on meat used.
VEGETABLES			
Baked jacket potatoes	5	2	1½ - 2 hrs.
PUDDINGS			
Milk Puddings (500ml/1pt)	3	2	1½ - 2 hrs.
Baked Custard (500ml/1pt)	3	2	45 mins - 1 hr. in bain-marie of cold water.
Baked Sponge Puddings	4	2	30 - 45 mins
Baked Apples	3	2	45 mins - 1 hr. depending on size
Meringue Topped Puddings	1	2	25 mins until tinged with brown
Apple Tart (1 x 205mm/8")	6	2	60 mins
Fruit Crumble	5	2	45 - 50 mins

If using aluminium foil:

1. Remember it is important to increase the cooking time by one third.
2. Do not allow the foil to touch the sides of the oven.
3. Do not cover the oven interior with foil.
4. Do not cover the oven shelves with foil.

TOP OVEN COOKING CHART

Food	Gas Mark	Shelf Positions	Approx. Cooking Time and Comments
CAKES, PASTRIES AND BISCUITS			
Small Cakes (16 per tray)	5	2	20 - 25 mins.
Victoria sandwich (2 x 180mm / 7")	4	2	25 - 30 mins.
Swiss Roll (3 egg quantity)	6	2	10 - 12 mins.
Christmas cake (1 x 205mm / 8")	2	2	4 - 5 hrs depending on recipe
Madeira cake (1 x 180mm / 7")	4	2	1 hr.
Rich Fruit cake (1 x 180mm / 7")	2	2	2¼ - 2½ hrs.
Gingerbread	3	2	1½ - 1¾ hrs.
Scones - 16 per tray	7	2	12 - 15 mins.
Shortbread (1 x 180mm / 7")	2	2	45 mins. - 1 hr. depending on thickness
Biscuits	4-6	2	15 - 25 mins.
Shortcrust Pastry	6	2	15 mins. - 1 hr. depending on recipe
Rich Short Crust	5	2	20 - 30 mins.
Flaky/Puff Pastry	7	2	10 - 30 mins. depending on recipe
Choux Pastry	6	2	25 - 35 mins.
YEAST MIXTURES			
Bread - rolls, plait	7	2 or 3	25 - 35 mins
Tea breads etc.	5	2	25 - 30 mins
MISCELLANEOUS			
Yorkshire Pudding - small	7	2	20 - 25 mins
- large	7	2	30 - 40 mins
Meringues	1	3	2½ - 4 hrs. turn when necessary

Soft Margarine – Use the oven settings recommended by the margarine manufacturer and **not** those indicated on the cooking chart.

CARE AND CLEANING

Switch off the electricity supply and allow to cool before cleaning the cooker.

Clean the cooker regularly and wipe up spills soon after they occur to prevent them from becoming burnt on. Never use biological washing powder, caustic cleaners, harsh abrasives, scouring pads, steam cleaners, aerosol cleaners or oven chemical cleaners of any kind.

Before moving your cooker ensure that it is cool and note that it is heavy (approximately 70 kg 155 lbs), so you may require assistance. To move the cooker forward, open the top oven/grill door and with both hands positioned under the roof of the compartment, lift and pull forward. Replace by pushing the cooker backwards. Check that the cooker is level. Take care to ensure that any floor covering is not damaged.

MAIN OVEN HEAT CLEAN LININGS

The oven roof, back and side linings are coated with a special enamel which has a continuous cleaning action. The higher the oven temperature the more effective the action. In most cases this cleaning operation will proceed during normal cooking. However, if roasting is done frequently, or high temperatures are not used regularly, it may be necessary to run the oven empty at Mark 8 for about two hours. It should not normally be necessary to clean the linings with water, but if desired, wipe them over with a soapy cloth, followed by a wipe with a damp clean cloth.

REPLACEMENT OF OVEN LIGHT BULB

CAUTION: DISCONNECT THE APPLIANCE FROM THE ELECTRICITY SUPPLY BEFORE REPLACING THE LAMP TO AVOID THE POSSIBILITY OF AN ELECTRIC SHOCK

Light bulbs are not covered by the manufacturer's guarantee.

A new 15W, 300°C rated SES bulb can be obtained from your cooker supplier or any major electrical retailer.

1. Remove the shelves from the oven.
2. Unscrew the lens using a thick cloth to protect your fingers in the unlikely event of a lens fracture.
3. Unscrew bulb.
4. Fit new bulb and refit lens.

CARE AND CLEANING

COOKER FINISH	CLEANING METHOD
<p>Vitreous Enamel Hotplate, pan supports, hotplate front trim, burner caps, roasting dish, grill pan, main oven base, inside of grill compartment, inside of doors.</p>	<p>Cloth wrung out in warm soapy water. Stubborn stains can be removed with a cream paste, liquid cleaner or by rubbing with fine steel wool soap pads. Check that the cleaning agent is approved by the Vitreous Enamel Association.</p>
<p>Paint Fascia bottom trim, fascia end caps, side panels.</p>	<p>Wash with a cloth wrung out in warm soapy water only. DO NOT USE ABRASIVES.</p>
<p>Aluminium Hotplate side trims, hotplate burner bodies, rear flue grille.</p>	<p>Similar to paint cleaning above. Use a nylon brush to remove any cleaning materials, water or dirt from the hotplate burner bodies.</p>
<p>Glass</p>	<p>As for enamel cleaning. Polish with a clean dry cloth or kitchen roll.</p>
<p>Chromium Plating Oven shelves, grill pan grid, grill pan handle support</p>	<p>Wipe with a cloth wrung out in warm soapy water. A fine steel wool soap pad e.g. Brillo, Ajax, or a chrome or stainless steel cleaner may be used.</p>
<p>Plastic Grill pan handle.</p>	<p>Wipe with a cloth wrung out in warm soapy water. Stubborn stains can be removed with a cream cleaner.</p>
<p>Stainless Steel Corner pillars, door trims, door handles, control knobs, plinth.</p>	<p>Wipe with a cloth wrung out in warm soapy water. Do not use chlorine based cleaners.</p>

CARE AND CLEANING

Take particular care not to damage the inner surface of the door inner glass that is coated with a heat reflective layer. Do not use scouring pads, or abrasive powder, which will scratch the glass. Ensure that the glass panel is not subjected to any sharp mechanical blows.

Stubborn stains can be removed by using a fine steel wool soap pad. For slight soiling the inner glass panel may be cleaned, while still warm, without removing it from the door. After cleaning, rinse and dry with a soft cloth.

CLEANING THE DOORS

SIDE OPENING DOORS

Cleaning the door glass is the same as the drop down doors, except take care to support the weight of the inner glass when removing and refitting.

DROP DOWN DOORS

Remove the door inner glass as follows.

1. Open the door fully and unscrew the two screws securing the glass panel so that the securing brackets can be turned. There is no need to remove the screws completely.
2. Turn the brackets so that the glass can be removed and cleaned at the sink (Fig. 1.)

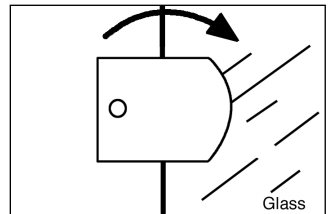

Fig. 1.

3. The inside of the outer door glass can now be cleaned while still fitted to the cooker.

NEVER OPERATE THE COOKER WITHOUT THE INNER DOOR GLASS IN POSITION.

Refit the door inner glass as follows.

1. **NOTE:** The inner door glass has a special reflective coating on one side. Replace the door inner glass so that the statement: **“IMPORTANT THIS FACE TOWARDS THE OVEN”** can be read from the inner side of the door.
2. Turn the two securing brackets back to their original position to retain the glass and tighten the screws. (Fig. 2.)

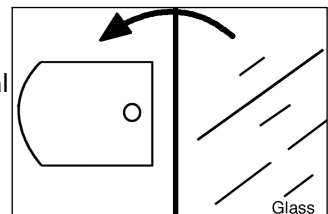
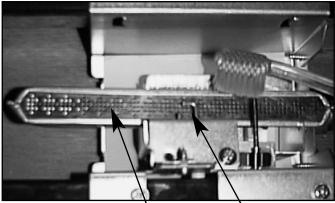
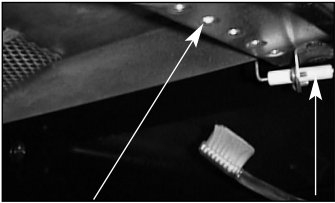
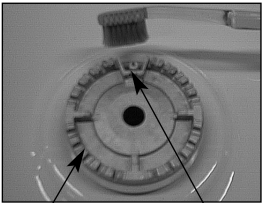

Fig. 2.

SOMETHING WRONG WITH YOUR COOKER

Before contacting your Service Centre or Installer, check the problem guide below, there may be nothing wrong with your cooker.

PROBLEM	CHECK
<p>Ignition does not work.</p> <p style="text-align: center;">Oven burner</p>  <p>Burner ports Ignitor</p> <p style="text-align: center;">Grill burner</p>  <p>Burner ports Ignitor</p> <p style="text-align: center;">Hotplate burner.</p>  <p>Burner ports Ignitor</p>	<p><u>If all burners fail to ignite:</u> Check that sparks appear at the burners; a clicking noise should be heard. If not</p> <p>Check that the electricity supply is turned on. If the electricity supply has failed, the hotplate burners and grill can be lit by a match.</p> <p><u>If only one burner fails to ignite:</u></p> <p>Check that the burner is dry and that spillage of food or cleaning fluid remains are not affecting the ignitor or burner ports. Clean away any debris with a dry nylon brush such as an old toothbrush. If a wire wool pad has been used for cleaning around the burner ensure the ignitor is free from any stray strands. Any water on the burner should be dried with a cloth or kitchen towel.</p> <p>On the hotplate make sure that all the burner parts are correctly seated.</p>

SOMETHING WRONG WITH YOUR COOKER

PROBLEM	CHECK
Slight odour or small amount of smoke when grill / oven used first time	This is normal and should cease after a short period.
Oven cooks too fast or too slow	Check that the gas mark and shelf positions are as recommended in the Oven Cooking Charts. However, it may be necessary to increase or decrease the recommended setting slightly to suit your taste.
Cannot set an "Auto Cook" programme or cannot get the timer to turn the oven on or off at the required times.	Read the Timer instructions in this book carefully remembering that the Cook period is the length of time that the timer will switch the oven(s) on as part of an Auto Cooking Programme.
Timer Display shows "0:00" with "Auto" Flashing.	The electricity supply to the cooker may have been interrupted, but has now come back on again. set the correct time of day by following the instructions given in the timer section of this book.
Main Oven does not work, but the grill, Top Oven and hotplate burners work.	The timer may be set for an Auto Cooking Programme. Check the timer to see if "AUTO" is illuminated. If it is, follow the instructions given in the timer section of this book to cancel the Auto Cooking Programme.
Oven lamp does not work	The oven lamp is not covered by the guarantee. The part is easily changed (see the section on oven lamp replacement) A new lamp may be obtained from our Spare Parts department by calling: 0541 530530

DISPOSAL OF YOUR PRODUCT:

To minimise the risk to injury to children please dispose of your product carefully and safely. Remove all doors and lids (where fitted). Remove the mains cable (where fitted) by cutting off flush with the appliance and always ensure that no plug is left in a condition where it could be connected to the electricity supply. To help the environment, Local Authority instructions should be followed for the disposal of your product.

INSTALLATION INSTRUCTIONS

Prior to installation, ensure that the local distribution conditions (nature of the gas and gas pressure) and the adjustment conditions are compatible. The adjustment conditions for this appliance are stated on the data badge which is fitted on the back panel.

This appliance is not designed to be connected to a combustion products evacuation device. It must be installed and connected in accordance with current installation regulations. Particular attention should be given to the relevant requirements regarding ventilation.

MODEL NUMBER 10410G

Category I_{2H} (GB. IE)

This model is set to burn NATURAL GAS (G20) at 20 mbar ONLY and can not be used on any other gas.

GAS SAFETY (INSTALLATION & USE) REGULATIONS

It is the law that all gas appliances are installed by competent persons in accordance with the current edition of the above regulations. It is in your interest and that of safety to ensure compliance with the law.

In the UK, CORGI registered installers work to safe standards of practice.

The cooker must also be installed in accordance with BS 6172.

Failure to install the cooker correctly could invalidate the warranty liability claims and could lead to prosecution.

LOCATION

The cooker may be located in a kitchen, kitchen/diner or a bed-sitting room, but not in a room containing a bath or shower. The cooker must not be installed in a bed-sitting room of less than 20m³.

PROVISION FOR VENTILATION

The room containing the cooker should have an air supply in accordance with BS 5440: Part 2.

The room must have an opening window or equivalent; some rooms may also require a permanent vent. If the room has a volume between 5 and 10m³, it will require an air vent of 50cm² effective area unless it has a door which opens directly to outside. If the room has a volume of less than 5m³, it will require an air vent of 100cm² effective area. If there are other fuel burning appliances in the same room, BS 5440: Part 2 should be consulted to determine air vent requirements.

INSTALLATION INSTRUCTIONS

TECHNICAL DATA

DIMENSIONS

Height	900 - 915mm
Width	600mm
Depth	615mm (excluding door handles)

GENERAL

Gas connection	Rp 1/2 (1/2" BSP female)
Pressure test point	Grill injector
Gas rate adjustment	None
Aeration adjustment	None
Electrical connection	Flexible cord fitted with a 3 pin 13 amp plug 230/240V a.c. 50Hz. 3A fuse.

BURNER	HEAT INPUT	INJECTOR
HOTPLATE Front left	3.3 kW	130
HOTPLATE Rear Right	3.0 kW	128
HOTPLATE Front Right & Rear Left	1.9 kW	102
GRILL	3.8 kW	150
MAIN OVEN	2.7 kW	120
TOP OVEN	2.0 kW	100

INSTALLATION INSTRUCTIONS

SPACE FOR FIXING

The cooker can be close fitted below hotplate level. This requires a minimum distance of 600mm between cupboard units of hotplate height.

When installing next to a tall cupboard, partition or wall, for a minimum distance of 400mm above hotplate level, allow a side clearance of at least 65mm.

The diagram below illustrates the minimum clearance between the cooker and adjacent walls, cupboards etc.

The wall behind the cooker between the hotplate and 450mm above, and the width of the cooker, must be a non-combustible material such as ceramic wall tiles.

If the cooker is to be fitted close to a corner on the left hand side, ensure that there is a clearance of at least 50mm to allow the main oven door to open fully for when removing oven shelves.

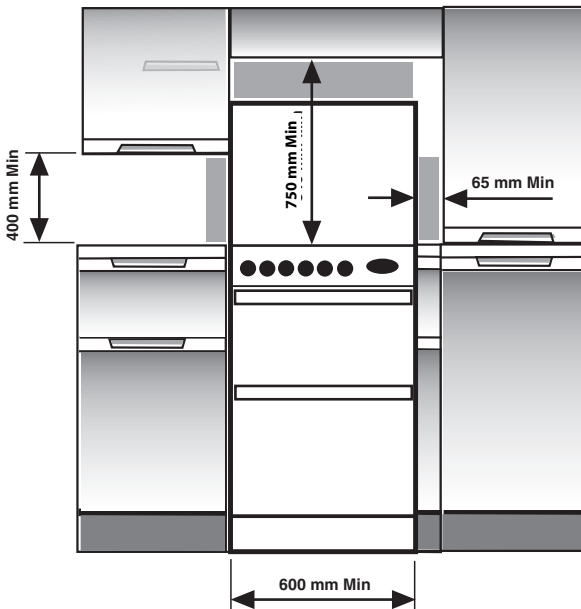

COOKER HOODS

If a cooker hood is to be installed, refer to the cooker hood manufacturers' instructions regarding fixing height.

INSTALLATION INSTRUCTIONS

UNPACKING THE COOKER

Unpack the components from inside the grill and oven: Check that the following parts are present.

Grill pan and grid	Top oven/grill shelf heat shield
Baking dish	Pan supports (2)
Main oven shelves (3)	Enamelled burner caps (5)
Aluminium burner bodies (4)	Main oven shelf heat shield
Literature	Top oven/grill shelf (1)

LEVELLING

Two rear wheels and two front feet are fitted which can be adjusted up or down to set the height (900mm - 915mm) and level the cooker.

1. The rear wheels can be raised or lowered from the BACK of the cooker by adjusting the levelling screws 'A' in the plinth.
2. The front feet can be simply screwed in or out to lower or raise the front of the cooker.

CAUTION: Some soft floor coverings may get damaged if the cooker is not moved carefully.

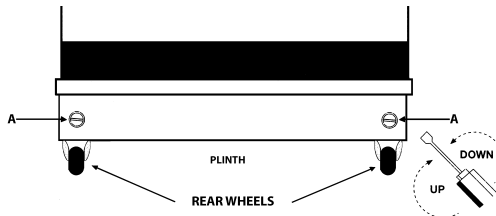

Viewed from rear

STABILITY BRACKET

The back of the cooker has a slot for engagement of a stability bracket, which can be obtained, as an extra, from your cooker supplier.

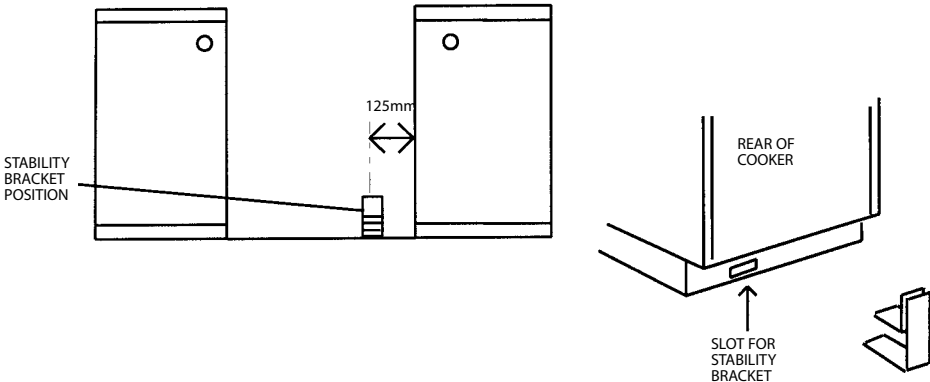

INSTALLATION INSTRUCTIONS

CONNECTING TO GAS SUPPLY

The cooker is designed to match the depth of standard 600mm worktops. An adaptor backplate should, therefore, be fitted within the shaded area shown to allow the cooker to be pushed fully to the wall.

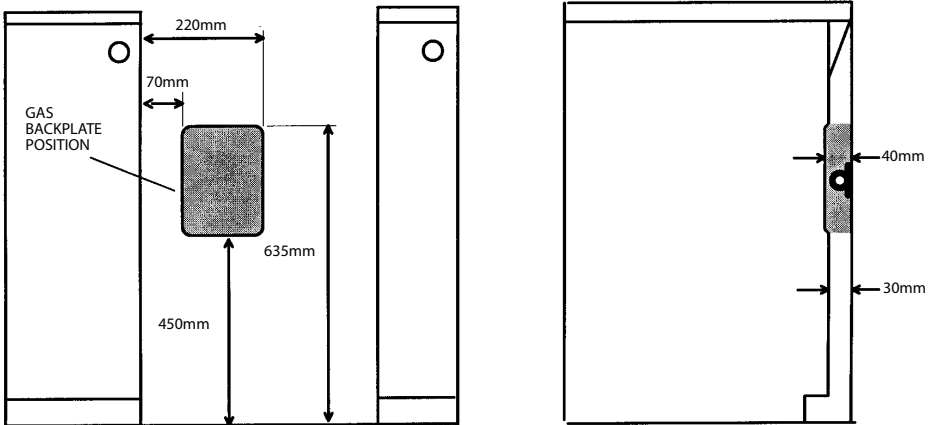
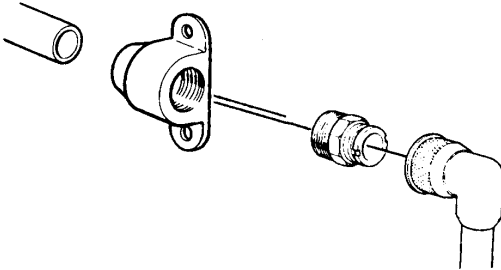

Connection to the cooker should be made with an approved appliance flexible connection to BS 669. A length of 0.9 to 1.25m is recommended. The length of hose chosen should be such that when the cooker is in situ, the hose does not touch the floor.

The temperature rise of areas at the rear of the cooker that are likely to come in contact with the flexible hose do not exceed 70°C.

ELECTRICAL CONNECTION

**WARNING – THIS APPLIANCE MUST BE EARTHED.
CONNECT TO A 230-240V A.C. SUPPLY ONLY.**

Connection to the electricity supply should be made via a properly earthed, readily accessible wall socket which is adjacent to but not directly above, and not more than 1.25m away from the appliance and capable of electrical isolation.

The mains lead should be routed such that it cannot touch hot parts of the cooker i.e. the back panel above a height of 650mm from the floor.

Should this plug not fit the socket outlet in your home it should be cut off and replaced with a suitable plug as outlined below.

NOTE: The removed plug cannot be used for any other appliance and should therefore be properly disposed of and not left where children might find it and plug it into a supply socket – with the obvious consequent danger.

IF THE FITTED PLUG IS REMOVED

The flexible mains lead must be correctly connected as below to a three pin plug of not less than 13 amp capacity. If a B.S. 1363 fused plug is used, it must be fitted with a 3 amp fuse which is approved to B.S. 1362.

IMPORTANT: The wires in the mains lead fitted to this appliance are coloured in accordance with the following code:

GREEN AND YELLOW	– EARTH
BLUE	– NEUTRAL
BROWN	– LIVE

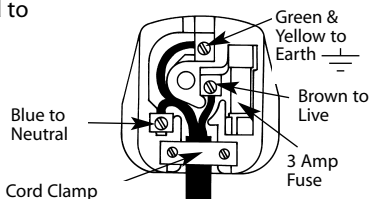

As the colours of the wires in the mains lead of this appliance may not correspond with the coloured markings identifying the terminals in your plug, proceed as follows:– The wire which is coloured green and yellow must be connected to the terminal in the plug which is marked with the letter E or by the earth symbol \equiv or coloured green or green and yellow. The wire which is coloured blue must be connected to the terminal which is marked with the N or coloured black. The wire which is coloured brown must be connected to the terminal which is marked with the letter L or coloured red. When wiring the plug, ensure that all strands of wire are securely retained in each terminal. Do not forget to tighten the mains lead clamp on the plug. As the appliance must be earthed, **do not use** 2-pin sockets outlets, **if you are in doubt, consult a qualified electrician.**

Should the mains lead ever require replacement, it is essential that this operation be carried out by a qualified electrician and should only be replaced with a flexible cord of the same size i.e. 0.75mm² cross sectional area and temperature rating of 85°C e.g. heat resisting PVC.

IF A MOULDED PLUG IS FITTED

In the event of replacing a fuse in the plug supplied a 3 amp ASTA approved fuse to BS1362 must be fitted.

NOTE: The fuse cover must be refitted when changing the fuse. In the event of losing the fuse cover the plug must not be used until a replacement fuse cover has been obtained and fitted. A new fuse cover can be obtained from your local Electricity Board. The colour of the correct replacement fuse cover is that of the coloured marks or inserts in the base of the plug.

Make sure that the cable does not become trapped when pushing the cooker into position.

INSTALLATION INSTRUCTIONS

INSTALLATION AND OPERATIONAL CHECKS

After installation, check for gas soundness. The supply pressure can be checked at the grill injector. Access to the injector is by first removing the baffle at the front of the grill fastened by two screws. Then remove the fastening screw on the right hand side of the burner and slide the burner off the injector. Ensure that the grill burner is correctly located under the fixing screw on reassembly.

Fit the hotplate burner bodies and caps, pan supports and shelf shield(s). Referring to the instructions for use where necessary,

1. Check that the hotplate and grill burners ignite correctly and burn with a steady flame. Check for a steady flame on the low setting.
2. Check that with the main oven set to mark 9, the burner ignites at low rate, and then increases to full rate within 60 seconds. Leave the oven full on with the door closed for 10 minutes, and check that when the control is turned to the 'Slow Cook' setting that the flame reduces. Allow the oven to cool. With the oven fan operating (duo mode button selected) check that the burner ignites at low rate, and then increases to full rate within 60 seconds. A slight disturbance of the flame in fan oven mode is normal.
3. Check that with the top oven set to mark 8, the burner ignites at low rate, and then increases to full rate within 60 seconds. Leave the oven full on with the door closed for 10 minutes, and check that when the control is turned to mark 1 that the flame reduces.
4. Check the operation of the oven timer and oven light(s).

Instruct the user on operation of the cooker.

NOTE: It is normal for a slight resistance to be felt when turning the Top Oven/Grill control to the oven settings, as the control operates a flap at the rear of the cooker.

Key Contacts

Service

Cannon has the largest appliance manufacturer's service team in Europe, trained specialists directly employed by us to ensure your complete confidence.

Repair Service

UK: 08709 066 066

Republic of Ireland: 1850 302 200

You will be asked for the following information:-

Name, address and postcode.

Telephone number

Model / Serial number of the appliance

Clear and concise details of the query or fault

Place and Date of purchase

(Please keep the receipt as evidence will be required when the engineer calls)

Extended Warranty

To join: UK 08709 088 088

Republic of Ireland: 1850 502 200

Genuine Parts & Accessories Mail Order Hotline

UK: 08709 077 077

Republic of Ireland: (01) 842 6836

For further product information 01782 385516

All Cannon Services are offered as an extra benefit and do not affect your statutory rights.



Merloni Elettrodomestici UK Ltd, Morley Way, Peterborough, PE2 9JB