



www.GEAppliancesCanada.com

Disposal[®] Food Waste Disposer

Safety Information
 Connecting Electricity 2, 3
 Safety Precautions 2

Installation Instructions
 Attaching the Discharge
 Elbow 6
 Components and Installation
 of Sink Flange 5
 Connecting Disposer to
 Sink Flange 7
 Dimensions/Typical
 Installations 8
 Dishwasher Connection 6

Operating Instructions
 Batch Feed Models 9
 Care and Maintenance 10
 Continuous Feed Models 9

Troubleshooting Tips
 Before You Call for
 Service 11

Customer Service
 Warranty 12

**Owner's Manual
& Installation
Instructions**

Model Line Series
 GFC500F
 GFC700F
 GFC1022F
 GFB762F

**Write the model and serial
numbers for your disposal here:**

Model # _____

Serial # _____

You can find them on a label on
the bottom of the disposer.



350A4502P268
560C464P01 REV B

IMPORTANT SAFETY INSTRUCTIONS. READ ALL INSTRUCTIONS BEFORE USING.

INSTRUCTIONS PERTAINING TO A RISK OF FIRE, ELECTRIC SHOCK OR INJURY TO PERSONS

⚠ **WARNING!**

When using electrical appliances, basic safety precautions should be followed, including the following:



SAFETY PRECAUTIONS

- Use this appliance only for its intended purpose as described in this Owner's Manual.
- Read all the instructions before using the appliance.
- To reduce the risk of injury, close supervision is required when an appliance is used near children.
- Do not put fingers or hands into a waste disposer.
- Turn the power switch to the off position before attempting to clear a jam or remove an object from the disposer.
- When attempting to loosen a jam in a waste disposer, use a long wooden object such as a wooden spoon or the wooden handle of a broom or mop.
- When attempting to remove objects from a waste disposer, use long-handled tongs or pliers. If the disposer is magnetically actuated, use only nonmagnetic tools.
- To reduce the risk of injury by materials that may be expelled by a waste disposer, do not put the following into a disposer:
 - a) Clam or oyster shells.
 - b) Caustic drain cleaners or similar products.
 - c) Glass, china or plastic.
 - d) Large whole bones.
 - e) Metal, such as bottle caps, tin cans, utensils or aluminum foil.
 - f) Hot grease or other hot liquids.
 - g) Whole corn husks.
- When not operating a disposer, leave the drain stopper in place to reduce the risk of objects falling into the disposer.
- **For proper grounding instructions see the ELECTRICAL CONNECTION portion of this manual.**

⚠ **WARNING!**

HOW TO CONNECT ELECTRICITY

If you are not familiar with electrical power and procedures, call a qualified electrician.

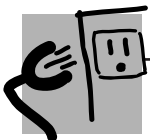

DANGER: Improper connection of the equipment-grounding conductor can result in a risk of electric shock. Check with a qualified electrician or serviceman if you are in doubt as to whether the appliance is properly grounded. Do not modify the plug provided with the appliance if it will not fit the outlet; have a proper outlet installed by a qualified electrician.

For Models Equipped with a Grounded Cord:
GROUNDING INSTRUCTIONS: This appliance must be grounded. In the event of a malfunction or breakdown, grounding provides a path of least resistance for electric current to reduce the risk of electric shock. This appliance is equipped with a cord having an equipment-grounding conductor and a grounding plug. The plug must be plugged into an appropriate outlet that is properly installed and grounded in accordance with all local codes and ordinances.

IMPORTANT SAFETY INSTRUCTIONS. READ ALL INSTRUCTIONS BEFORE USING.

www.GEAppliancesCanada.com

⚠ WARNING!

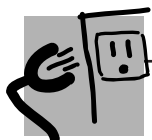

HOW TO CONNECT ELECTRICITY (cont.)

If you are not familiar with electrical power and procedures, call a qualified electrician.

The power cord and/or connections must comply with the National Electrical Code.

For Models Not Equipped with a Cord:

If your disposer does not come equipped with a cord, you can connect it in two ways:

1. Attach a power cord, minimum 18" in length and not to exceed 36" in length.

or

2. Wire the disposer directly into the house current.

To Attach a Power Cord:

GROUNDING INSTRUCTIONS: This appliance must be grounded. In the event of malfunction or breakdown, grounding provides a path of least resistance for electric current to reduce the risk of electric shock. The power cord (to be installed) must have an equipment-grounding conductor and a grounding plug. The plug must be plugged into an appropriate outlet that is properly installed and grounded in accordance with all local codes and ordinances.

DANGER: Improper connection of the equipment-grounding conductor can result in a risk of electric shock. Check with a qualified electrician or serviceman if you are in doubt as to whether the appliance is properly grounded.

NOTE: Disconnect electric power to disposer circuit before installation. Turn the circuit breaker to the **OFF** position or remove the fuse.

- A. Connect the disposer to 110–120 Volt, 60 Hz AC current only.
- B. If a plug-in cord is used, use a three-prong plug.

Ground wire should be attached to the ground screw in the bottom of the disposer (end bell).

Trace lead connected to this blade and attach that lead to white wire on disposer. Ribbed Side



NOTE: When viewing face of electrical plug with grounding pin at top, the larger left blade is connected to the identified wire.

- C. Use a cable clamp strain relief connector where power cord enters the disposer.

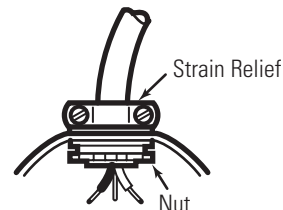

To Wire Your Disposer Directly into the House Current:

GROUNDING INSTRUCTIONS: This appliance must be connected to a grounded, metal, permanent wiring system; or an equipment-grounding conductor must be run with the circuit conductors and connected to the equipment-grounding terminal or lead on the appliance.

- A. If you use BX cable:

1. Install the cable connector in the hole.
2. Connect white wire to white lead of disposer.
3. Connect black wire.
4. Connect bare ground wire.

If BX cable is not used, provide a separate ground wire to nearest reliable ground, using the screw in the end bell for the ground wire.

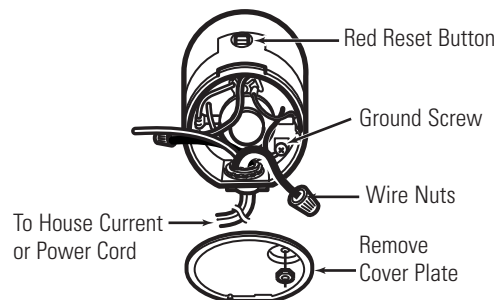

Bottom of the Disposer (end bell)

- B. If your power supply does not include a ground wire, you must provide one unless metal cable is used. Attach a copper wire securely to disposer ground screw and attach other end of wire to a reliable ground. Use only CSA approved ground clamp. If plastic pipe is used in your home, a qualified electrician should install a proper ground.



READ AND FOLLOW THIS SAFETY INFORMATION CAREFULLY.

SAVE THESE INSTRUCTIONS

Installation Instructions

Disposer

If you have questions, call 1-800-361-3400 or visit our Website at: www.GEAppliancesCanada.com

BEFORE YOU BEGIN

Read these instructions completely and carefully.

- **IMPORTANT** – Save these instructions for local inspector's use.
- **IMPORTANT** – Observe all governing codes and ordinances.
- **Note to Installer** – Be sure to leave these instructions with the Consumer.
- **Note to Consumer** – Keep these instructions for future reference.
- **Skill level** – Installation of this appliance requires basic mechanical skills.
- **Completion time** – 1 hour
- Proper installation is the responsibility of the installer.
- Product failure due to improper installation is not covered under the Warranty.

PREPARATION

1. Disconnect electrical power supply to disposer.
2. Remove old disposer or sink flange assembly.
3. Inspect drain line. If it is heavily coated with hardened grease and accumulations, rout out with a plumber's snake.
4. Remove old sealing materials and gasketing from sink opening, both top and bottom.

NOTE: Top and bottom of sink surfaces must be free of any materials to prevent leaks.

WHAT YOU WILL NEED

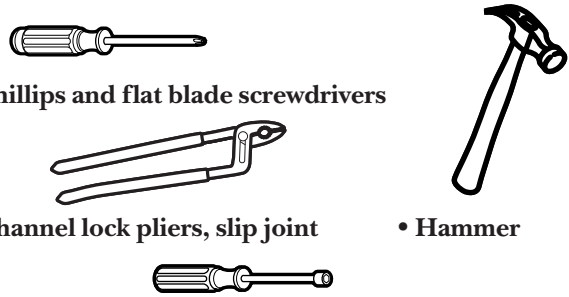
- 
- Phillips and flat blade screwdrivers
 - Channel lock pliers, slip joint
 - Hammer
 - Nut driver

ADDITIONAL MATERIALS YOU MAY NEED

- Steel punch or wooden dowel
- Petroleum jelly or liquid soap
- Hose clamp
- Dishwasher drain connector
- Adjustable pipe wrench
- Plumber's putty (for cast sinks)
- Stepped rubber drain adapter
- Wire nuts
- Cable connector
- Flexible drain pipe
- Power cord kit (Part Number PM3X215GDS)

Installation Instructions

1 COMPONENTS AND INSTALLATION

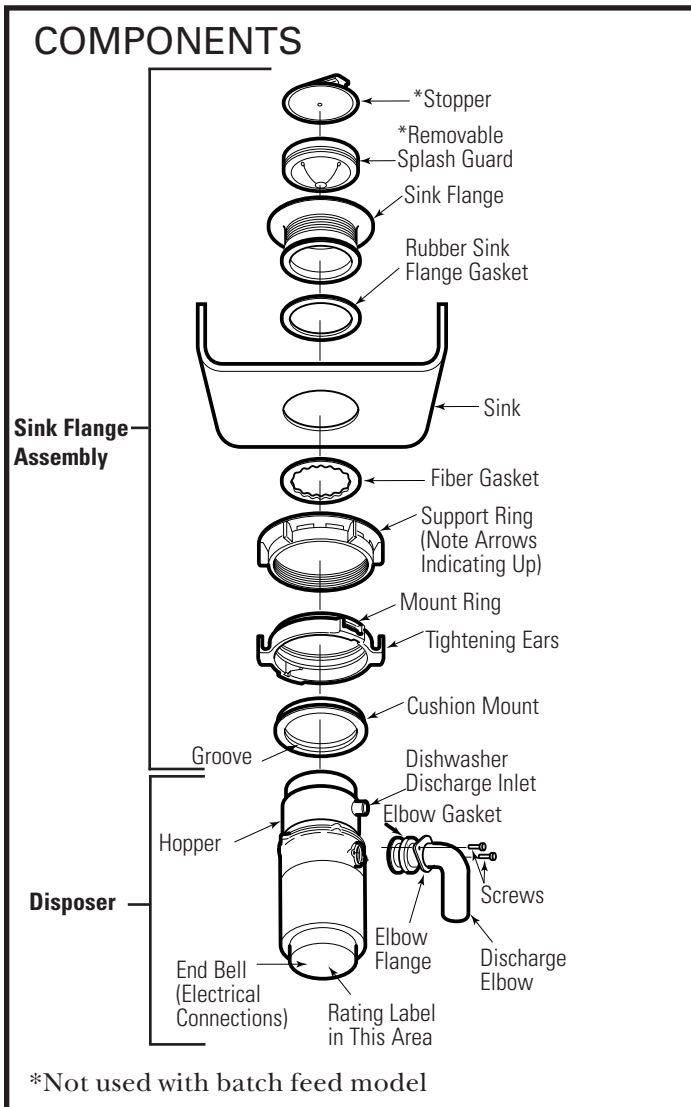

NOTE: Pay close attention to the order of the sink flange parts, as they have been correctly assembled by the factory.

- Disassemble the sink flange assembly from the disposer by turning the mount ring to the left (clockwise) and removing it.
- Raise the mount ring toward the top of the sink flange. Remove the cushion mount and the mount ring. You may want to practice installing the cushion mount at this point before you are under the sink.
- Unscrew the support ring from the sink flange and remove the fiber gasket. You are now left with the sink flange and the rubber gasket.
- The rubber gasket is used instead of plumbers putty with stainless steel sinks. Some cast sinks will require putty.**
- If no putty is used, insert the sink flange through the rubber gasket into the sink opening. Do not turn the flange once it is seated.
- If you use putty instead of the gasket, form a ring around the underside of the sink flange. Insert the flange into the sink opening, press down hard to squeeze out excess putty. From under the sink, trim off excess putty flush with the bottom edge of the sink opening.

- From underneath the sink, slip the fiber gasket onto the exposed sink flange. With arrows pointing up, screw the support ring onto the sink flange and hand tighten until the sink flange will not move. At this point you may want to insert the stopper in the sink and fill with water to check the sink flange seal and insure there are no leaks.

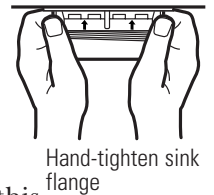

- Place the mount ring over the sink flange and hold in place while installing the cushion mount (large side down). Make sure the groove on the inside of the cushion mount fits over the lip on the sink flange, similar to putting the lid on a plastic container.



Cushion Mount Detail

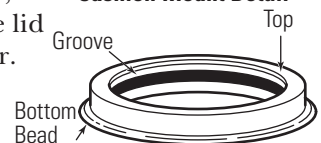

Run your fingers around the entire cushion mount with slight pressure. Do not press too hard. When the cushion mount is properly seated, the mount ring can be pulled downward over the cushion mount and will be free to turn.

INSTALLATION OF SINK FLANGE (Read completely before starting.)

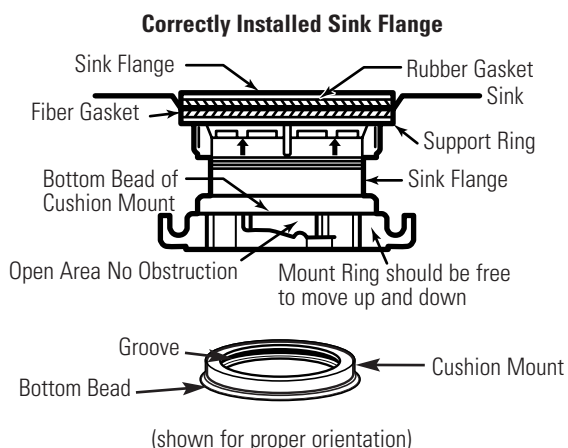

Installation Instructions

2 DISHWASHER CONNECTION (IF REQUIRED)

If you are connecting to a dishwasher, complete the following step. If a dishwasher is not to be connected, go on to “Attaching the Discharge Elbow” section.

1 KNOCK OUT PLUG

Using a blunt instrument (steel punch or wooden dowel), knock out entire plug. Do not use a screwdriver or sharp instrument. When knockout plug falls into disposer, you may remove it or simply grind it up when the disposer is used. This will not damage the disposer in any way, but may take some time to grind, over the course of several uses.

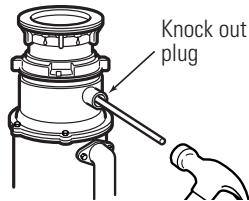

2 CONNECT HOSE

Connect the dishwasher hose using a hose clamp. If the hose size is different, you will need a stepped rubber adapter.



Hose Clamp

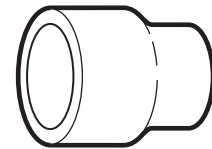

Stepped Rubber Adapter

3 ATTACHING THE DISCHARGE ELBOW

CONNECT DISCHARGE ELBOW

Connect the discharge elbow to the disposer.* Make sure all plumbing connections are tight.

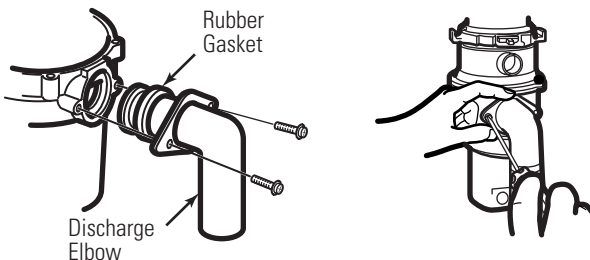

* Some installations (see page 8 for examples) may require the use of a flexible drain pipe.

Installation Instructions

4 CONNECTING DISPOSER TO SINK FLANGE

1 ATTACH TO SINK FLANGE

Line up the disposer under the sink flange. Guide the hopper projections into the mount ring slots. Turn the mount ring about 1/4" to the right so that the disposer is temporarily supported.

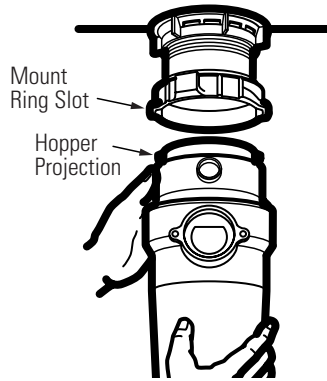

2 LINE UP WITH OUTLET PIPE

Turn the mount ring and the disposer until the disposer discharge elbow lines up with the outlet pipe (see page 8).

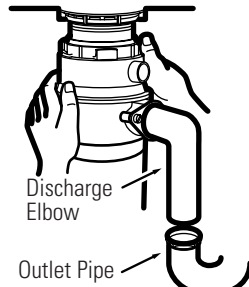

3 LOCK MOUNT RING

Turn the mount ring to the right until it locks up tight. Hopper projections must be to the extreme left of the mounting slots. If the mount ring is hard to turn, you may add a small amount of petroleum jelly or liquid soap to the hopper projection. Run water and check for leaks.

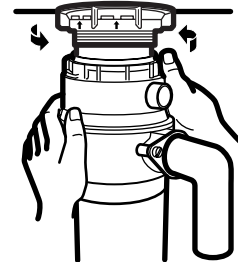

Locking Detail

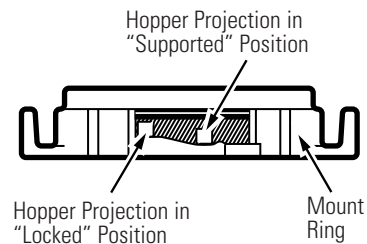

4 CHECK FOR LEAKS

Check the unit for leaks 24 hours after installation and first operation.

Installation Instructions

DIMENSIONS

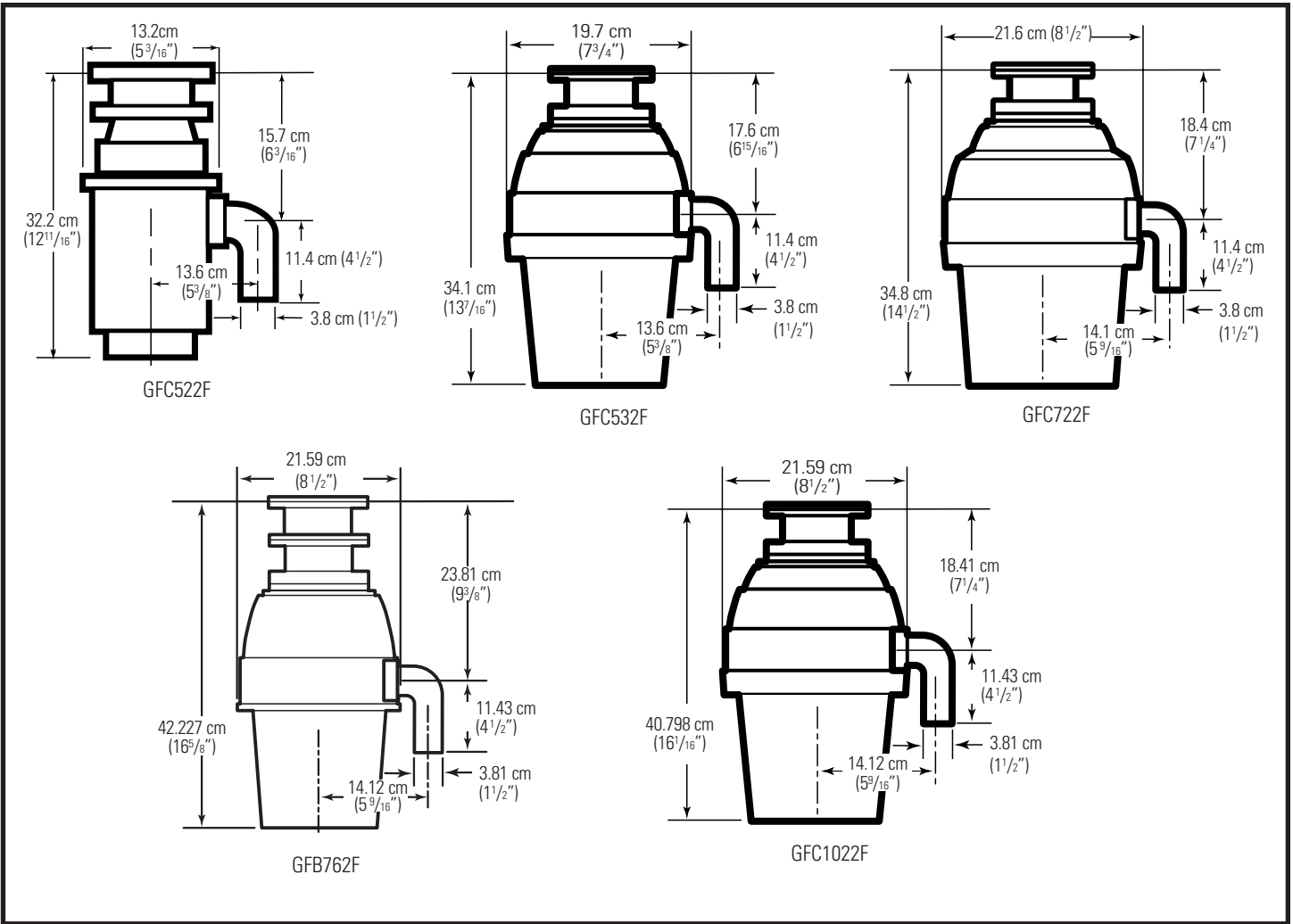

SOME TYPICAL INSTALLATIONS

Direct replacement for most makes & models.

*22.8 cm (9") for model GFC522F

*25.4 cm (10") for models GFC532F, GFC722F and GFC1022F.

*30.48cm (12") for models GFB762F.

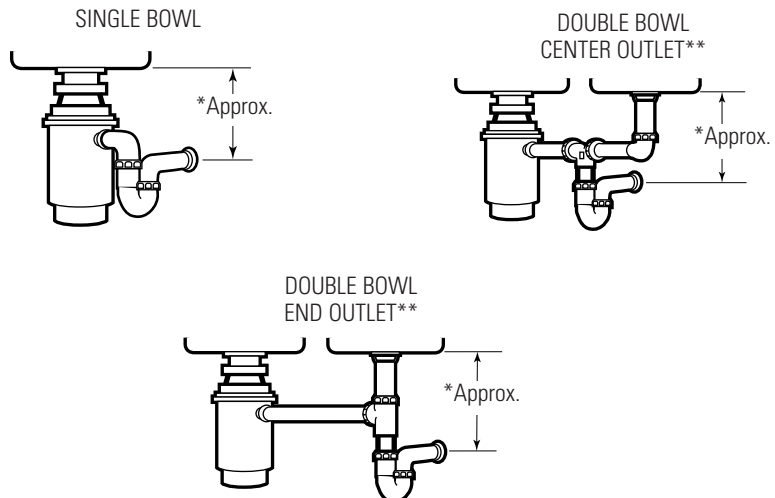

NOTE: It is essential for the proper operation of the disposer that this dimension be 9"-12", depending upon the models listed above, to avoid standing water in disposer motor housing.

**Flexible drain pipe may be necessary for this application.

This disposer uses anti-jam swivel impellers that make a clicking sound as they swing into place. This indicates normal operation.

Continuous Feed Models

- A. Remove the sink stopper and turn on a medium flow of cold water.
- B. Turn the switch to **ON**.
- C. Scrape in food waste. To speed up food waste disposal, cut or break up large bones, rinds and cobs. Large bones and fibrous husks require considerable grinding time and are more easily thrown away with other trash. Do not be alarmed that the disposer slows down while grinding. The disposer is actually increasing torque (grinding power) and is operating under normal conditions.
- D. Before turning the disposer off, let the water and the disposer run for approximately 25 seconds after shredding stops. This assures that all waste is thoroughly flushed through the trap and drain.
- E. Do not use hot water while running the disposer. Cold water will keep food waste and fats solid so they can be flushed down the drain.

Batch Feed Models

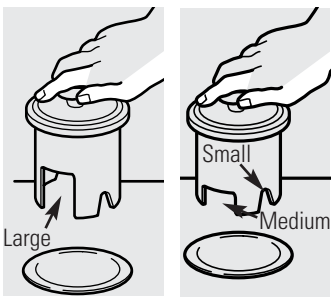
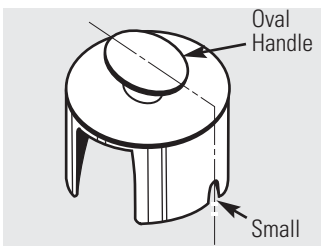
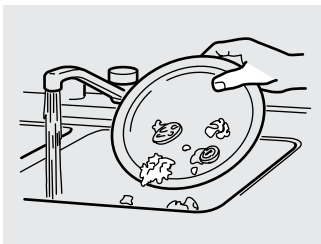

- A. Remove the sink stopper and turn on a medium flow of cold water.
- B. Scrape in food waste.
- C. Insert the stopper to start the disposer. One of the two small slots in the stopper base must line up with the switch plunger inside the neck of the disposer.
NOTE: The oval shaped handle aligns with the 2 small slots in the stopper.
Push down firmly to start.
- D. Run the disposer for 25 seconds after shredding stops. This assures that all waste is thoroughly flushed through the trap and drain.
Lift the stopper to shut the disposer off.
- E. To fill the sink, insert the stopper so that the largest slot lines up with the switch plunger. The stopper can now be pushed down to seal the sink without starting the disposer. When the medium-sized slot in the stopper base is lined up with the switch plunger, water can drain, but tableware, etc., cannot be accidentally dropped into the disposer.

Operating instructions.

Helpful Hints

- A. Be sure the disposer is empty before using the dishwasher so it can drain properly.
- B. You may want to leave the stopper in the drain when not in use to prevent utensils and foreign objects from falling into the disposer.
- C. The disposer is ruggedly built to give you years and years of trouble-free service. It will handle all normal food wastes—BUT it will not grind and dispose such items as tin cans, bottles and bottle caps, glass, china, leather, cloth, crockery, rubber, string, feathers, or clam or oyster shells. These are waste materials and belong in the trash can or trash compactor.
- D. **TO SPEED UP FOOD WASTE DISPOSAL...** Cut or break up large bones, melon rinds, grapefruit skins and corn cobs. Items such as large bones, fibrous husks like lima bean pods and corn husks require considerable cutting time. For this reason, you may prefer to place them in the trash can or trash compactor.

Care and maintenance.

THE MOTOR IS PERMANENTLY LUBRICATED FOR LIFE. DO NOT ATTEMPT TO LUBRICATE YOUR DISPOSER. The disposer is self cleaning and scours itself with each use.

- **NEVER** put lye or chemical cleaners into the disposer, as they cause serious corrosion of metal parts.
- Your disposer, except for the Batch Feed model, is equipped with a removable splash guard for ease of cleaning or replacement. Remove the splash guard by pulling it out from the top. To replace, insert into the sink flange and push down until it is properly seated.
- If an odor develops, run orange or lemon rinds through the disposer. A dozen ice cubes sprinkled with a little household scouring powder will also work.



Troubleshooting Tips
Save time and money! Review the chart on this page first and you may not need to call for service.

SAFETY NOTE: Before investigating, you must disconnect the power supply.

⚠ WARNING!

Before resetting, disconnect the power supply—please see SAFETY NOTE above. The overload control prevents the motor from operating should overloading occur. This feature protects your house wiring and your disposer. When overloaded, the motor will stop automatically.

Problem	Possible Causes	What To Do
Loud noises (other than those during grinding of bones and fruit pits)	Silverware, bottle cap or other foreign object has fallen into the disposer.	<ul style="list-style-type: none"> Remove the splash guard* and remove the object with long-handled tongs. Replace the splash guard*.
Disposer does not start	Reset button has been tripped.	<ul style="list-style-type: none"> With the splash guard* removed, check to see if the turntable will move freely using a broom handle. If the turntable moves freely, replace the splash guard* and check the reset button to see if it has been tripped. The reset button is red and located opposite the discharge elbow, near the bottom of the disposer. Push the button in until it clicks and remains depressed. If the reset button has not been tripped, check for a shorted or broken wire connecting to the disposer. Check the electrical power switch, fuse box or circuit breaker. If wiring and electrical components are intact, the unit may have internal problems that require service or replacement.
	Turntable cannot rotate.	<ul style="list-style-type: none"> If the turntable does not turn freely, check for an object lodged between the turntable and the grind ring. Dislodge the object by moving the turntable with a broom handle. Then remove the object. <p>If no foreign object is present, there may be internal problems.</p>
Disposer leaks	<p>If the leak is at the top, it may be caused by:</p> <ol style="list-style-type: none"> 1. Improper seating of sink flange (gasket choice, putty or tightening). 2. Support ring not tightened properly. 3. Defective cushion mount. <p>If the leak is at the discharge elbow, leak may be caused by improper tightening of elbow flange screws.</p>	

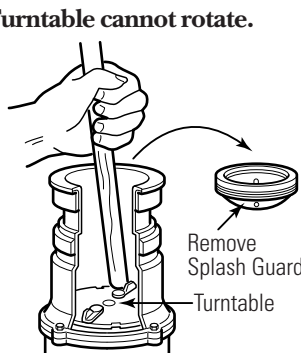
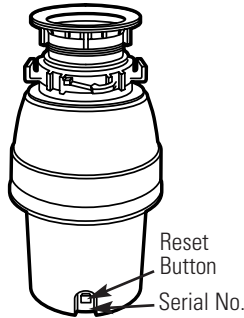

*Batch Feed does not include splash guard.

Disposer Warranty.



All warranty service provided by our Factory Service Centers, or an authorized Customer Care® technician. For service, call 1-800-361-3400.

Staple your receipt here.
Proof of the original purchase date is needed to obtain service under the warranty.

For The Period Of:	GE Will Replace:
One Year From the date of the original purchase	The entire disposer if there is a defect in materials or workmanship relating to functional parts only (appearance parts are excluded). During this full one-year warranty , GE will also provide, free of charge , all labor charges related to replacing the original disposer along with the replacement disposer within the first year.
Additional Four Years From the date of the original purchase	Models GFC722F and GFB762F: If there is a defect in materials or workmanship relating to functional parts only (appearance parts are excluded). During this four year extended limited warranty period, you will be responsible for all installation charges relating to the replacement disposer.
Additional Six Years From the date of the original purchase	Models GFC1022F: If there is a defect in materials or workmanship relating to functional parts only (appearance parts are excluded). During this six year extended limited warranty period, you will be responsible for all installation charges relating to the replacement disposer.

What Is Not Covered:

- Service trips to your home to teach you how to use the product.
- Improper installation.
- Failure of the product if it is abused, misused, or used for other than the intended purpose or used commercially.
- Replacement of house fuses or resetting of circuit breakers.
- Damage to the product caused by accident, fire, floods or acts of God.
- Incidental or consequential damage to personal property caused by possible defects with this appliance.

Read your Owner's Manual. If you then have any questions about operating the product, please contact your dealer or our Consumer Relations office at:

Manager, Consumer Relations
 Camco Inc.
 1 Factory Lane, Suite 310
 Moncton, N.B.
 E1C 9M3

Or Call, toll free: 1-800-361-3400

WARRANTOR IS NOT RESPONSIBLE FOR CONSEQUENTIAL DAMAGES.

Warrantor: CAMCO INC.