

Integrated amplifier
User's manual
2

ENGLISH

azur

350A

 **Cambridge Audio**
Your music + our passion

Contents

Introduction	2
Important safety instructions	3
Limited warranty.....	4
Rear panel connections.....	5
Front panel controls.....	6
Remote control.....	7
Connections.....	8
Technical specifications	10
Troubleshooting.....	10

Introduction

Thank you for purchasing your Azur 350A. We are confident that you will enjoy many years of listening pleasure from it. Like all Cambridge Audio products, the Azur 350A adheres to three core principles – stunning performance, ease of use and incredible value.

The design of a high quality but cost-effective audio amplifier presents a major challenge. Providing first-class performance on an unlimited budget is one matter; achieving the same performance within tight price limits is quite another, and requires the expertise and experience that Cambridge Audio brings to its product design process. We believe we have succeeded in our aim of creating a first-class affordable amplifier.

In this product separate very high quality Integrated Circuit Amplifiers modules are used for each channel for freedom from crosstalk and best possible stereo imaging.

Close attention has been paid to the performance and quality of the passive components, both in the signal paths and for decoupling purposes. A Very high-quality black box film type volume pot from ALPS has been specified for its superior sound quality and excellent channel balance.

The power supply is also a vital part of any power amplifier. A toroidal transformer, selected for low external magnetic field, is used in conjunction with generously specified reservoir capacitors and optimally placed decoupling components.

The 350A incorporates tone controls that give subtle control of the frequency response, allowing the correction of imperfect source material, and compensation for loudspeaker inadequacies or problems with room acoustics. These tone controls can be switched completely out of the audio path by use of the DIRECT switch, to give the shortest possible audio path.

The 350A has full protection against misuse and possible faults. The overload and short-circuit protection systems continuously monitor the voltage, current and temperature of the output devices, allowing the protection to act positively in case of need, without triggering spuriously.

Our new casework design is featured with a thicker braced front panel, more rigid wrap-over lid assembly and dual-layer damped feet, all of which contribute to better resonance control.

An MP3/Portable Media Player input has been fitted to the front panel for convenience, and the supplied remote can control the amplifier, any of our matching CD players and basic functionality of iPods in our own or Apple docks.

Your amplifier can only be as good as the system it is connected to. Please do not compromise on your source equipment, speakers or cabling. Naturally, we particularly recommend models from the Cambridge Audio Azur range, which have been designed to the same exacting standards as our amplifiers. Your dealer can also supply excellent quality Cambridge Audio interconnects to ensure your system realises its full potential.

Thank you for taking the time to read this manual; we recommend you keep it for future reference.



Matthew Bramble
Cambridge Audio Technical Director
and the 350A design team

Make sure you register your purchase.

Visit: www.cambridge-audio.com/sts

By registering, you'll be the first to know about:

- Future product releases
- Software upgrades
- News, events and exclusive offers plus competitions!

This guide is designed to make installing and using this product as easy as possible. Information in this document has been carefully checked for accuracy at the time of printing; however, Cambridge Audio's policy is one of continuous improvement, therefore design and specifications are subject to change without prior notice.

This document contains proprietary information protected by copyright. All rights are reserved. No part of this manual may be reproduced by any mechanical, electronic or other means, in any form, without prior written permission of the manufacturer. All trademarks and registered trademarks are the property of their respective owners.

© Copyright Cambridge Audio Ltd 2010

Important safety instructions

For your own safety please read the following important safety instructions carefully before attempting to connect this unit to the mains power supply. They will also enable you to get the best performance from and prolong the life of the unit:

1. Read these instructions.
2. Keep these instructions.
3. Heed all warnings.
4. Follow all instructions.
5. Do not use this apparatus near water.
6. Clean only with a dry cloth.
7. Do not block any ventilation openings. Install in accordance with the manufacturer's instructions.
8. Do not install near any heat sources such as radiators, heat registers, stoves, or other apparatus (including amplifiers) that produce heat.
9. Do not defeat the safety purpose of the polarized or grounding-type plug. A polarized plug has two blades with one wider than the other. A grounding-type plug has two blades and a third grounding prong. The wide blade or the third prong are provided for your safety. If the provided plug does not fit into your outlet, consult an electrician for replacement of the obsolete outlet.
10. Protect the power cord from being walked on or pinched, particularly at plugs, convenience receptacles and the point where they exit from the apparatus.
11. Only use attachments/accessories specified by the manufacturer.
12. Use with only the cart, stand, tripod, bracket, or table specified by the manufacturer, or sold with the apparatus. When a cart is used, use caution when moving the cart/apparatus combination to avoid injury from tip-over. 
13. Unplug this apparatus during lightning storms or when unused for long periods of time.
14. Refer all servicing to qualified service personnel. Servicing is required when the apparatus has been damaged in any way, such as the power-supply cord or plug having been damaged, liquid has been spilled or objects have fallen into the apparatus, the apparatus has been exposed to rain or moisture, does not operate normally, or has been dropped.

WARNING

- To reduce the risk of fire or electric shock, do not expose this unit to rain or moisture.
- Batteries (battery pack or batteries installed) shall not be exposed to excessive heat such as sunshine, fire or the like.

The unit is of Class 1 construction and must be connected to a mains socket outlet with a protective earthing connection.

The unit must be installed in a manner that makes disconnection of the mains plug from the mains socket outlet (or appliance connector from the rear of the unit) possible. Where the mains plug is used as the disconnect device, the disconnect device shall remain readily operable. Only use the mains cord supplied with this unit.

Please ensure there is ample ventilation. We recommend that you do not place the unit in an enclosed space; if you wish to place the unit on a shelf, use the top shelf to allow maximum ventilation. Do not put any objects on top of this unit. Do not situate it on a rug or other soft surface and do not obstruct any air inlets or outlet grilles. Do not cover the ventilation grilles with items such as newspapers, tablecloths, curtains, etc.

This unit must not be used near water or exposed to dripping or splashing water or other liquids. No objects filled with liquid, such as vases, shall be placed on the unit.



The lightning flash with the arrowhead symbol within an equilateral triangle is intended to alert the user to the presence of un-insulated 'dangerous voltage' within the product's enclosure that may be of sufficient magnitude to constitute a risk of electric shock to persons.

The exclamation point within an equilateral triangle is intended to alert the user to the presence of important operating and maintenance instructions in the service literature relevant to this appliance.



WEEE symbol

The crossed-out wheeled bin is the European Union symbol for indicating separate collection for electrical and electronic equipment. This product contains electrical and electronic equipment which should be reused, recycled or recovered and should not be disposed of with unsorted regular waste. Please return the unit or contact the authorised dealer from whom you purchased this product for more information.



CE mark

This product complies with European Low Voltage (2006/95/EC), Electromagnetic Compatibility (2004/108/EC) and Environmentally-friendly design of Energy-related Products (2009/125/EC) Directives when used and installed according to this instruction manual. For continued compliance only Cambridge Audio accessories should be used with this product and servicing must be referred to qualified service personnel.



C-Tick mark

This product meets the Australian Communications Authority's Radio communications and EMC requirements.



Ross Test Stamp

This product meets Russian electronic safety approvals.

FCC regulations

NOTE: THE MANUFACTURER IS NOT RESPONSIBLE FOR ANY RADIO OR TV INTERFERENCE CAUSED BY UNAUTHORIZED MODIFICATIONS TO THIS EQUIPMENT. SUCH MODIFICATIONS COULD VOID THE USER AUTHORITY TO OPERATE THE EQUIPMENT.



This equipment has been tested and found to comply with the limits for a Class B digital device, pursuant to Part 15 of the FCC Rules. These limits are designed to provide reasonable protection against harmful interference in a residential installation. This equipment generates, uses and can radiate radio frequency energy and, if not installed and used in accordance with the instructions, may cause harmful interference to radio communications. However, there is no guarantee that interference will not occur in a particular installation.

If this equipment does cause harmful interference to radio or television reception, which can be determined by turning the equipment off and on, the user is encouraged to try to correct the interference by one or more of the following measures:

- Re-orient or relocate the receiving antenna.
- Increase the separation between the equipment and receiver.
- Connect the equipment into an outlet on a circuit different from that to which the receiver is connected.
- Consult the dealer or an experienced radio/TV technician for help.

Ventilation

IMPORTANT - The unit will become hot when in use. Do not stack multiple units on top of each other. Do not place in an enclosed area such as a bookcase or in a cabinet without sufficient ventilation.

Ensure that small objects do not fall through any ventilation grille. If this happens, switch off immediately, disconnect from the mains supply and contact your dealer for advice.

Positioning

Choose the installation location carefully. Avoid placing it in direct sunlight or close to a source of heat. No naked flame sources, such as lighted candles, should be placed on the unit. Also avoid locations subject to vibration and excessive dust, cold or moisture. The unit can be used in a moderate climate.

This unit must be installed on a sturdy, level surface. Do not place in a sealed area such as a bookcase or in a cabinet. Do not place the unit on an unstable surface or shelf. The unit may fall, causing serious injury to a child or adult as well as serious damage to the product. Do not place other equipment on top of the unit.

Due to stray magnetic fields turntables or CRT TVs should not be located nearby due to possible interference.

Electronic audio components have a running in period of around a week (if used several hours per day). This will allow the new components to settle down, the sonic properties will improve over this time.

Power sources

The unit should be operated only from the type of power source indicated on the marking label. If you are not sure of the type of power-supply to your home, consult your product dealer or local power company.

To turn the unit off, switch off on the front panel. If you do not intend to use this unit for a long period of time, unplug it from the mains socket.

Overloading

Do not overload wall outlets or extension cord as this can result in a risk of fire or electric shock. Overloaded AC outlets, extension cords, frayed power cords, damaged or cracked wire insulation, and broken plugs are dangerous. They may result in a shock or fire hazard.

Be sure to insert each power cord securely. To prevent hum and noise, do not bundle the interconnect leads with the power cord or speaker leads.

Cleaning

To clean the unit, wipe its case with a dry, lint-free cloth. Do not use any cleaning fluids containing alcohol, ammonia or abrasives. Do not spray an aerosol at or near the unit.

Battery disposal

Please dispose of any discharged batteries according to local environmental/electronic waste disposal guidelines.

Loudspeakers

Before making any connections to loudspeakers, make sure all power is turned off and only use suitable interconnects.

Servicing

These units are not user serviceable, never attempt to repair, disassemble or reconstruct the unit if there seems to be a problem. A serious electric shock could result if this precautionary measure is ignored. In the event of a problem or failure, please contact your dealer.

Limited warranty

Cambridge Audio warrants this product to be free from defects in materials and workmanship (subject to the terms set forth below). Cambridge Audio will repair or replace (at Cambridge Audio's option) this product or any defective parts in this product. Warranty periods may vary from country to country. If in doubt consult your dealer and ensure that you retain proof of purchase.

To obtain warranty service, please contact the Cambridge Audio authorised dealer from which you purchased this product. If your dealer is not equipped to perform the repair of your Cambridge Audio product, it can be returned by your dealer to Cambridge Audio or an authorised Cambridge Audio service agent. You will need to ship this product in either its original packaging or packaging affording an equal degree of protection.

Proof of purchase in the form of a bill of sale or receipted invoice, which is evidence that this product is within the warranty period, must be presented to obtain warranty service.

This Warranty is invalid if (a) the factory-applied serial number has been altered or removed from this product or (b) this product was not purchased from a Cambridge Audio authorised dealer. You may call Cambridge Audio or your local country Cambridge Audio distributor to confirm that you have an unaltered serial number and/or you purchased from a Cambridge Audio authorised dealer.

This Warranty does not cover cosmetic damage or damage due to acts of God, accident, misuse, abuse, negligence, commercial use, or modification of, or to any part of, the product. This Warranty does not cover damage due to improper operation, maintenance or installation, or attempted repair by anyone other than Cambridge Audio or a Cambridge Audio dealer, or authorised service agent which is authorised to do Cambridge Audio warranty work. Any unauthorised repairs will void this Warranty. This Warranty does not cover products sold AS IS or WITH ALL FAULTS.

REPAIRS OR REPLACEMENTS AS PROVIDED UNDER THIS WARRANTY ARE THE EXCLUSIVE REMEDY OF THE CONSUMER. CAMBRIDGE AUDIO SHALL NOT BE LIABLE FOR ANY INCIDENTAL OR CONSEQUENTIAL DAMAGES FOR BREACH OF ANY EXPRESS OR IMPLIED WARRANTY IN THIS PRODUCT. EXCEPT TO THE EXTENT PROHIBITED BY LAW, THIS WARRANTY IS EXCLUSIVE AND IN LIEU OF ALL OTHER EXPRESS AND IMPLIED WARRANTIES WHATSOEVER INCLUDING, BUT NOT LIMITED TO, THE WARRANTY OF MERCHANTABILITY AND FITNESS FOR A PRACTICAL PURPOSE.

Some countries and US states do not allow the exclusion or limitation of incidental or consequential damages or implied warranties so the above exclusions may not apply to you. This Warranty gives you specific legal rights, and you may have other statutory rights, which vary from state to state or country to country.

For any service, in or out of warranty, please contact your dealer.

Plug Fitting Instructions (UK Only)

The cord supplied with this appliance is factory fitted with a 13 amp mains plug fitted with a 3 amp fuse inside. If it is necessary to change the fuse, it is important that a 3 amp one is used. If the plug needs to be changed because it is not suitable for your socket, or becomes damaged, it should be cut off and an appropriate plug fitted following the wiring instructions below. The plug must then be disposed of safely, as insertion into a 13 amp socket is likely to cause an electrical hazard. Should it be necessary to fit a 3-pin BS mains plug to the power cord the wires should be fitted as shown in this diagram. The colours of the wires in the mains lead of this appliance may not correspond with the coloured markings identifying the terminals in your plug. Connect them as follows:

The wire which is coloured BLUE must be connected to the terminal which is marked with the letter 'N' or coloured BLACK.

The wire which is coloured BROWN must be connected to the terminal which is marked with the letter 'L' or coloured RED.

The wire which is coloured GREEN/YELLOW must be connected to the terminal which is marked with the letter 'E' or coloured GREEN.

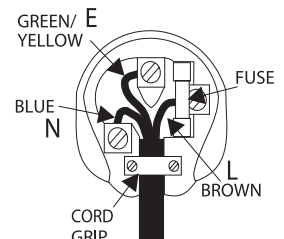

If a 13 amp (BS 1363) plug is used, a 3 amp fuse must be fitted, or if any other type of plug is used a 3 amp or 5 amp fuse must be fitted, either in the plug or adaptor, or on the distribution board.

Rear panel connections

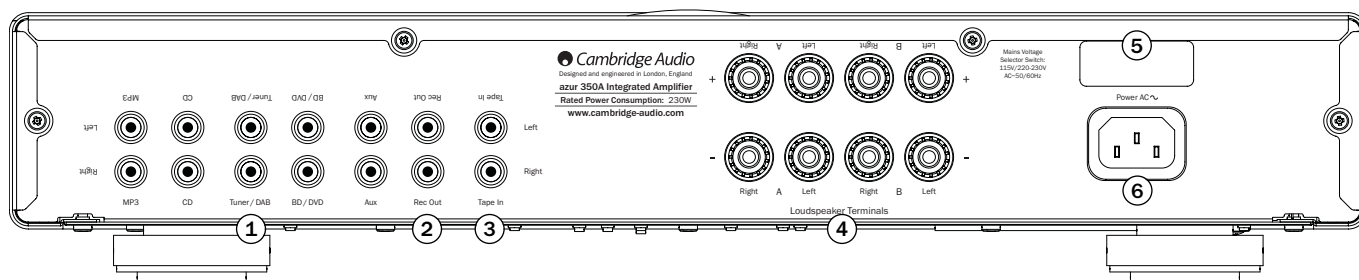

① MP3, CD, Tuner/DAB, BD/DVD, Aux

These inputs are suitable for any 'line level' source equipment such as BD/DVD players, DAB or FM/AM tuners, CD players, MP3 players, etc.

Note: These inputs are for analogue audio signals only. They should not be connected to the digital output of a CD player or any other digital device.

② Record Out

These output sockets can be connected to a tape deck or to the analogue Record In sockets on a MiniDisc or CD recorder.

③ Tape In

Connect to a tape deck or to the analogue output sockets on a MiniDisc, portable digital music player or CD recorder using an interconnect cable from the recorder's Line Out sockets to the amplifier's Tape In sockets.

The Tape Input circuit of the 350A is a 'monitor' type, different from the other six inputs. For the six normal inputs, the source selected for listening to will also be sent out of the Rec outputs for recording. The source currently being listened to and (optionally) recorded is then shown on the front panel by a corresponding blue LED.

However, when the Tape Mon Input is selected, the Tape Mon LED will also illuminate, indicating that the Tape Monitor Input is now being listened to with a different source being sent out of the Rec outputs for recording. The recording source is shown by the first LED and can be changed by pressing the other source buttons. To switch Tape Monitor off, simply press the Tape Mon button again, toggling this function off.

This feature is most useful when using three-head analogue cassette decks which allow the signal being recorded to be played back live off tape (via a third head) whilst it is simultaneously recorded. It is then possible, by toggling the Tape Monitor input on and off, to compare directly in real time the original and recorded signal so that adjustments to the recording parameters of the tape machine can be made. (Consult the manual of your three-head analogue cassette deck for full details).

④ Loudspeaker terminals

Two sets of loudspeaker terminals are available, A (main loudspeaker terminals, left terminals) and B (secondary switchable loudspeaker terminals, right terminals). Connect the wires from your left channel loudspeaker to the LEFT positive and negative terminals, and the wires from the right channel loudspeaker to the RIGHT positive and negative terminals. In each case, the red terminals are the positive outputs and the black terminals are the negative outputs.

Care should be taken to ensure no stray strands of wire are shorting speaker outputs together. Please ensure that the loudspeaker terminals have been tightened adequately to provide a good electrical connection. It is possible for the sound quality to be affected if the screw terminals are loose.

The use of A and B speakers affords you an easy and inexpensive way to create a simple multi-room system.

Note: When using two pairs of speakers, use speakers with a nominal impedance of 8ohms.

⑤ Mains voltage selector switch

Switches the mains voltage between 115V and 220-230V. For use by installer/dealer only.

⑥ AC power socket

Once you have completed all connections to the amplifier, plug the AC power cable into an appropriate mains socket and turn the unit on. Your amplifier is now ready for use.

Front panel controls

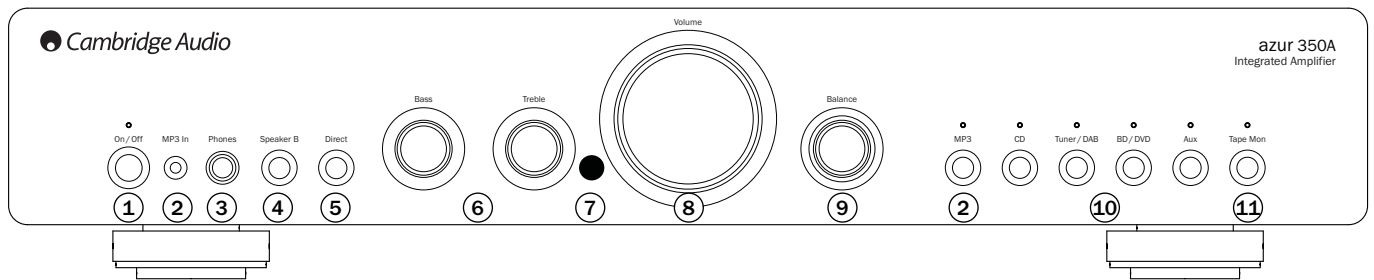

① Power On/Off

Switches the unit on or off.

② MP3 Input

This source input allows you to connect a portable audio device such as an MP3 player, plugged into either the rear panel Phono/RCA input pair (labelled 'MP3') or the front panel 3.5mm stereo-jack input (labelled 'MP3 In').

Press the MP3 button on the front panel to select the input, or insert a device into the front panel socket which automatically selects the input and overrides the rear Phono/RCA sockets.

③ Phones

Allows for the connection of headphones with a ¼" jack plug connector. Headphones with an impedance of between 32 and 600ohms are recommended. When the headphones are connected, the loudspeaker relay is released switching off the output to the loudspeakers (speakers A and B).

④ Speaker B

Turns on/off the secondary set of loudspeaker terminals on the back panel. This can be used for listening to an extra set of loudspeakers in another room.

Please note that care should be taken when selecting if two loudspeakers are going to be used on each channel. If the combined resistance measured on the loudspeaker terminals is too low the amplifier may not switch out of Standby mode until a suitable load resistance is detected.

Note: When using two pairs of speakers, use speakers with a nominal impedance of between 6-8 ohms each.

⑤ Direct

This control gives the audio signal a more direct path to the power amplifier stage of your amplifier, bypassing the bass and treble control circuits for the purest possible sound quality.

⑥ Bass and Treble

These controls allow subtle adjustments to the tonal balance of the sound. In the central position these controls have no effect. They only modify the sound through your loudspeakers and do not affect the signals sent through the Rec Out connections. With a well-produced CD and a good system, the tone controls are unnecessary and can be switched off by the 'Direct' switch. If the musical recording is of poor quality or other factors are affecting the sound quality, it may be necessary to adjust the tone controls to compensate.

⑦ Infrared sensor

Receives IR commands from the supplied Azur remote control. A clear, unobstructed line of sight between the remote control and the sensor is required.

⑧ Volume

Use to increase or decrease the level of the sound from the outputs of the amplifier. This control affects the level of the loudspeaker output, the preamp output and the headphone output. It does not affect the Rec Out connections. It is advisable to turn the Volume control fully anti-clockwise before switching the amplifier on.

⑨ Balance

This control allows you to adjust the relative output levels of the left and right channels. In the central position the output from each channel is equal. This control only modifies the sound through your loudspeakers - it does not affect the signals sent through the Rec Out connections.

⑩ CD, Tuner/DAB, BD/DVD, Aux

Push the appropriate input selection button to select the source component that you wish to listen to. The signal selected is also fed to the Tape Out sockets so that it may be recorded. The input should not be changed whilst recording (but the recorded signal can be checked using the tape input Tape Monitor).

⑪ Tape Monitor

This control lets you listen to the output signal from a tape recorder or signal processor connected to the amplifier's Tape In/Rec Out sockets. When Tape Monitor is selected, the source component chosen by the input selection buttons continues to be routed to the Rec Out sockets for recording or processing.

Remote control

The 350A is supplied with an Azur Navigator remote control that operates both this amplifier and Cambridge Audio Azur range CD players. Insert the supplied AAA batteries to activate. Always use alkaline-type batteries.

Mute

Mutes the audio on the amplifier. The mute mode is indicated by the source and speaker LEDs flashing. Press again to cancel mute.

Note: The speaker outputs, Pre-out and headphone outputs will all be muted. The Record outputs are unaffected.

Volume controls

Increases or decreases the volume of the amplifier output.



The six source select buttons are used to directly select the input source to the amplifier.

Note: the *Tape Monitor* input works in a slightly different way – please refer to your amplifier user’s manual for details.

Please note that the following buttons will only operate a matching Cambridge Audio Azur CD player:

Standby/On

Switches the 350C between On and low power eco-friendly Standby mode.

Open/Close

Opens and closes the disc tray.

Numerical track select

Press the number of the desired track. The track will then play automatically from the start of the track.

Track select

To select a track number greater than nine, press -/-- followed by the track number. Playback of the chosen track starts automatically.

Play/ Stop/ Pause

Press the relevant button to play, stop or pause the CD.

Skip

Right Skip Press to skip forward by one track on the CD.

Left Skip Press to skip backward by one track on the CD.

Scan

Press and hold to scan within the selected track. Hold down for seven seconds to increase scan speed. Press the right button to fast forward, the left button to rewind.

Info

Used with CDs that support CD-text. In stop mode, press to toggle between album name and total time on the display. During playback, press to toggle between track name and track time.

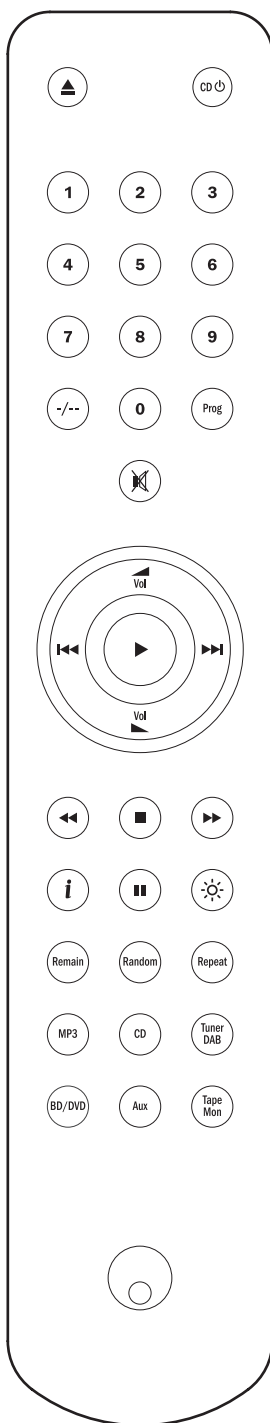

Bright

Alters the brightness of the display backlight. There are three levels of brightness: Bright, Dim and Off.

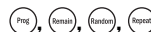

Read the 'Operating Instructions' section of your Azur CD player's manual for information on the functions of these buttons.

Note: these buttons will function only when the display backlight is in either 'Bright' or 'Dim' modes. If it is set to 'Off', the functions do not respond.

iPod compatibility

The Azur 350AC Navigator remote control can control the basic functions of Apple iPods when mounted in Cambridge Audio iPod dock or Apple's Universal Dock. Refer to your dock's instruction manual on how to connect it to your amplifier.

To use the Azur remote to control the docked iPod, hold down the  button whilst pressing one of the following buttons:

Play/Pause

Press to play the iPod, press again to pause play.

Skip

Press once to skip forwards or backwards one track.

Release the  button to return the remote control to normal functionality.

iPod is a trademark of Apple Inc., registered in the U.S. and other countries.

Connections

Loudspeakers

Check the impedance of your speakers. When using a pair of speakers, you can use types with an impedance of between 4 and 8 Ohms.

The red coloured speaker terminals are positive (+) and the black speaker terminals are negative (-). Make sure correct polarity is maintained at each speaker connector or the sound can become weak and “phasey” with little bass.

Using bare wire connections

Prepare the speaker cords for connection by stripping off approximately 10mm (3/8”) or less of the outer insulation. More than 10mm could cause a short circuit. Twist the wires tightly together so there are no loose ends. Unscrew the speaker terminal, insert the speaker cable, tighten the terminal and secure the cable.



Note: All connections are made using standard loudspeaker cable.

Basic connection

The diagram below shows the basic connection of your unit to a CD player and a pair of loudspeakers.

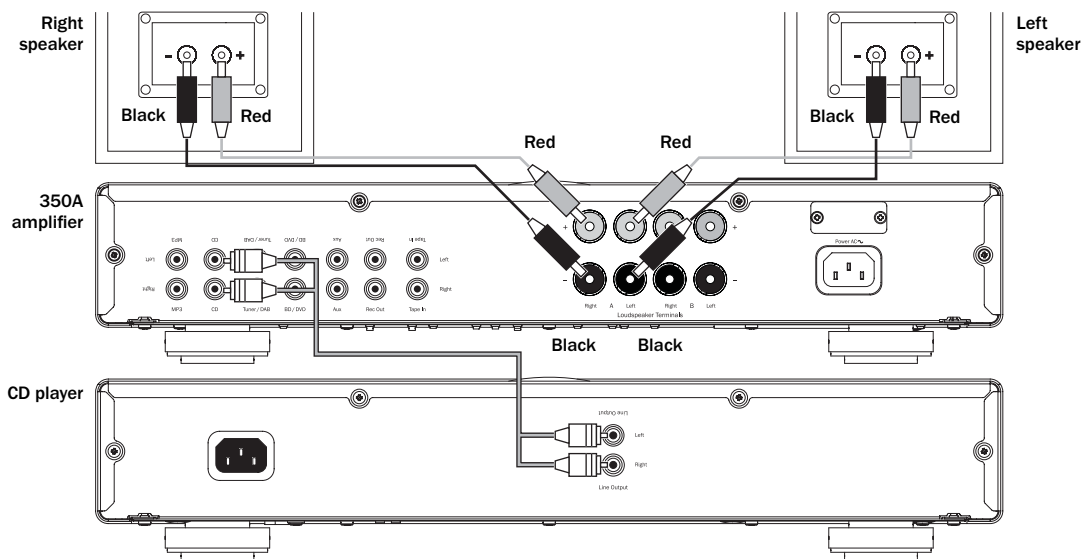

Tape connection

The diagram below shows how to connect the amplifier to a tape recorder or other source with a record and monitor connection. Please note that either of the tape loop outputs can be used (as they are both the same signal in parallel).

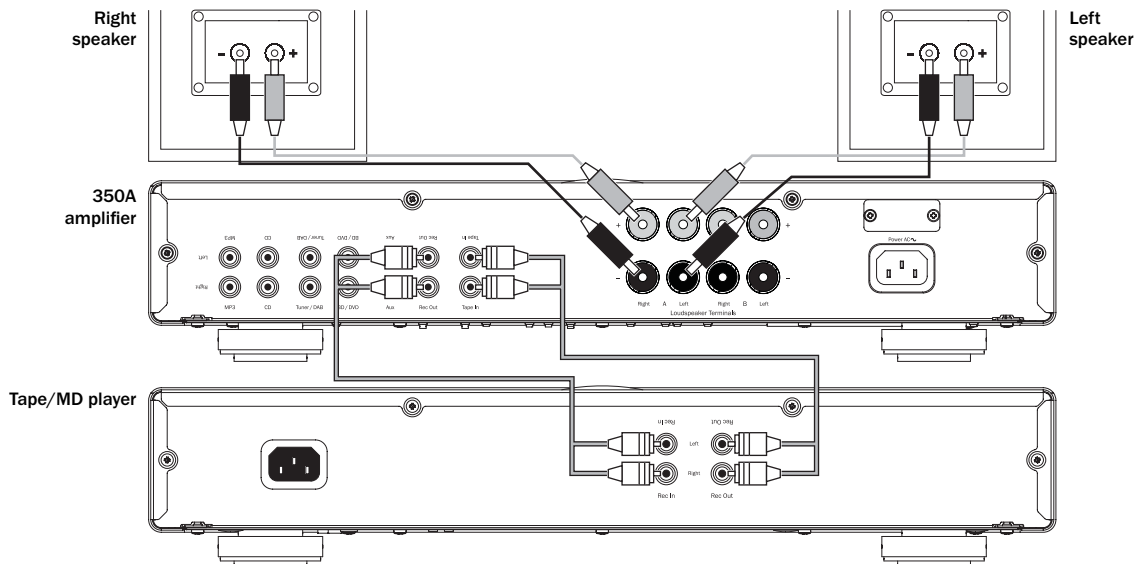

Speaker B connections

The Speaker B connections on the back of the amplifier allow for a second set of speakers to be used (ie speakers located in another room). The Speaker B button on the front panel allows this second set of speakers to be switched on and off.

Note: When using two pairs of speakers, use speakers with a nominal impedance of between 6-8 ohms each.

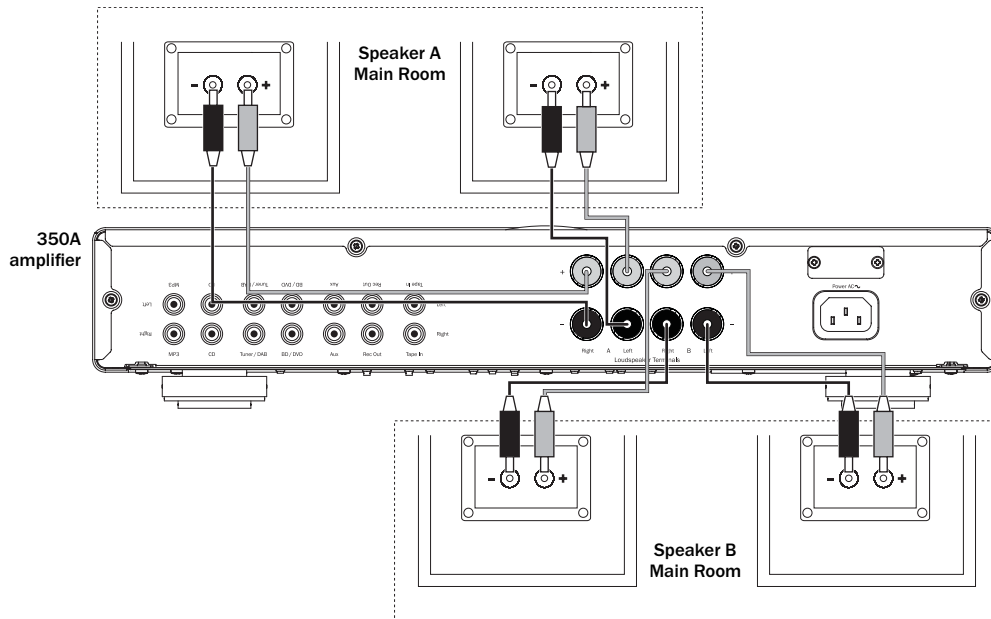

Technical specifications

Power output	45 watts (into 8Ω)
THD (unweighted)	<0.02% @ 1kHz, 80% of rated power <0.15% 20Hz - 20kHz, 80% of rated power
Frequency response (-1dB)	5Hz - 50kHz
S/N ratio (ref 1W)	>92dB (unweighted)
Input impedances	47k ohms
Max. power consumption	320W
Bass/Treble controls	Shelving, ultimate boost/cut +/- 10dB @ 20Hz and +/- 6dB @ 20kHz
Dimensions	86 x 430 x 340mm (3.4 x 16.9 x 13.4")
Weight	6.0kg (13.2lbs)

Troubleshooting

There is no power

Ensure the AC power cord is connected securely.
Ensure the plug is fully inserted into the wall socket and is switched on.
Check the unit is switched on at the rear panel.
Check fuse in the mains plug or adaptor.

There is no sound

Make sure the unit is not in Standby mode.
Check that the source component is properly connected.
Check that 'Tape Mon' is not switched on (unless tape input is required).
Check that your speakers are properly connected.
Check that the correct speaker outputs are switched on ('Speaker B' button on the front panel).
If source LED is flashing, turn 'Mute' off.

There is no sound on one channel

Ensure that balance control is in the correct position.
Check speaker connections.
Check interconnects.

There is a loud buzz or hum

Check turntable or tone arm for ground and connection lead fault.
Ensure no interconnects are loose or defective.
Ensure that your tape deck or turntable is not too close to the amplifier.

Unable to make or play tape recordings

Check that 'Tape In' and 'Rec Out' have been connected correctly.

There is weak bass or diffused stereo imaging

Ensure that speakers are not wired out of phase.

The sound is distorted

Check that the volume or tone controls are not set too high.

The remote handset will not function

Check that the batteries have not expired.
Ensure that nothing is blocking the remote sensor.

In the event that the above solutions do not remedy your problem, please consult our frequently asked questions (FAQ) section on our website: www.cambridge-audio.com/sts/faqs

For all servicing, in or out of warranty, please contact your dealer.

