

**AC POWERED STROBE LIGHT  
FOR THE HEARING IMPAIRED**

Input: 120V AC ~, 60Hz  
Strobe: 177 candela minimum

UL STANDARD 1971

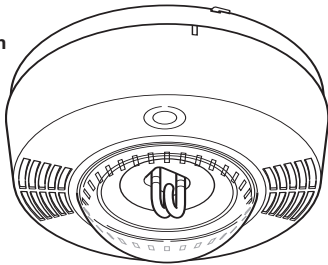

M08-0188-000 J1 05/07 Printed in Mexico

**IMPORTANT! PLEASE READ CAREFULLY AND SAVE.**

This user's manual contains important information about your Strobe Light's operation. If you are installing this Strobe Light for use by others, you must leave this manual—or a copy of it—with the end user.

**TABLE OF CONTENTS**

Introduction .....1  
 Before You Install This Strobe Light .....1  
 Recommended Placement For Hearing Impaired Strobe Lights .....1-2  
 Weekly Testing .....2  
 How To Install This Strobe Light .....2-3  
 Regular Maintenance .....3  
 If This Strobe Light Activates .....4  
     If an Interconnected CO Alarm Sounds .....4  
     If an Interconnected Smoke Alarm Sounds .....4  
 If You Suspect A Problem .....4  
 Special Compliance Considerations .....5  
 Limitations of Strobes .....5  
 Limited Warranty .....5

© 2007 BRK Brands, Inc., a Jarden Corporation company (NYSE: JAH)  
 3901 Liberty Street Road, Aurora, IL 60504-8122  
 All rights reserved.  
 Consumer Affairs: (800) 323-9005  
 www.brkelectronics.com • www.firstalert.com

**INTRODUCTION**

Thank you for choosing First Alert for your hearing impaired Strobe Light needs. You have purchased a state of the art Strobe Light designed to provide hearing impaired individuals with a visual warning of a fire or a carbon monoxide danger when used with smoke, heat or carbon monoxide alarms. Please take the time to read this manual and make the Strobe Light an integral part of your family's safety plan.

**Key Features of the SL177 Strobe Light:**

**Smart Strobe:** Separate flash patterns to distinguish smoke/heat or CO danger. Can be interconnected with First Alert® and BRK® smoke, CO, smoke/CO combo and heat alarms.

**177 Candela Xenon Light:** Powerful 177 candela xenon strobe light provides effective visual warning to awaken hearing impaired residents.

**Smart Interconnect:** One interconnect wire carries smoke and CO alarm signals.

**Meets ADA Requirements:** Meets the requirements of the Americans with Disabilities Act (ADA).

**⚠WARNING!**

This device is not a smoke, heat or carbon monoxide alarm. It must be interconnected with operating alarms to provide protection. It will not work without AC power.

**BEFORE YOU INSTALL THIS STROBE LIGHT**

**IMPORTANT!** Read "Recommended Placement for Hearing Impaired Strobe Lights".

This Strobe Light is intended to be interconnected with functioning smoke, heat or carbon monoxide alarms. It has no means of detection on its own. It will not operate without AC power. Its operation is specifically designed to wake hearing impaired persons as specified by NFPA 72, Underwriters Laboratories (UL 1971), Americans with Disabilities Act (ADA) and ANSI 117.1.

This Strobe Light can ONLY give an early warning of a potentially dangerous fire or CO incident if it is installed, maintained and located where hearing impaired residents can see it, as described in this manual. This unit will not sense smoke, carbon monoxide, gas, heat or flame. It cannot prevent or extinguish fires.

**Check Your Local Building Codes**

This Strobe Light is designed to be used in typical residential single-family or multi-family dwellings and institutional applications including sleeping areas of hospitals, hotels, motels, nursing homes, long term health care facilities, day care facilities, dormitories or other similar dwellings. See "Special Compliance Considerations" for details.

**⚠DANGER!**

**ELECTRICAL SHOCK HAZARD.** Turn off power to the area where you will install this Strobe Light at the circuit breaker or fuse box before beginning installation. Failure to turn off the power before installation may result in serious electrical shock, injury or death.

**⚠WARNING!**

- Installation of this Strobe Light must conform to the electrical codes in your area; Articles 210, 760 of NFPA 70 (NEC), NFPA 72, NFPA 101; SBC (SBCCI); UBC (ICBO); NBC (BOCA); OTFDC (CABO), and any other local or building codes that may apply. Wiring and installation must be performed by a licensed electrician. Failure to follow these guidelines may result in injury or property damage.
- This Strobe Light must be powered by a 24-hour, 120VAC 60Hz circuit. Be sure the circuit cannot be turned off by a switch, dimmer, or ground fault circuit interrupter. Failure to connect this Strobe Light to a 24-hour circuit may prevent from providing constant protection.
- It is possible an electrical fire could occur on the circuit powering this Strobe Light. If this happened, power to the unit could be cut off and it may fail to activate. Some safety experts recommend wiring warning devices like this unit on separate circuits from other appliances, since these circuits are not as likely to be overloaded. Other safety experts recommend wiring these units on the same circuits as appliances so it is more readily apparent if the circuit fails.
- Never disconnect the power from an AC powered Alarm to stop an unwanted alarm. Doing so will disable the unit and remove your protection. In the case of a true unwanted alarm open a window or fan the smoke away from the interconnected units. The interconnected alarm will reset automatically when it returns to normal operation. Never remove the batteries from a battery operated Alarm to stop an unwanted alarm (caused by cooking smoke, etc.). Instead open a window or fan the smoke away. The Alarm will reset automatically.

**RECOMMENDED PLACEMENT FOR HEARING IMPAIRED STROBE LIGHTS**

According to NFPA 72, at a minimum a strobe should be installed within 16 feet (4.9 meters) of the pillow.

For wall mounting, the strobe should be between 80 to 96 inches (203 to 244 cm) above the floor.

For ceiling mounting: Ideally, the strobe should be located near the center of the room. See diagram.

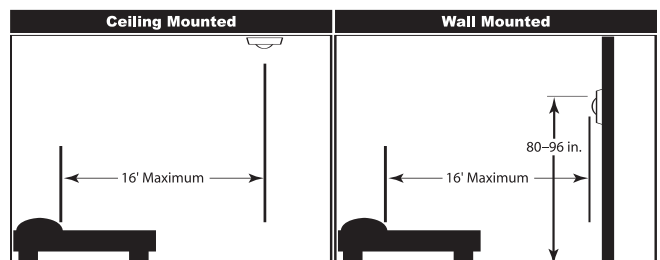

**⚠WARNING!**

This strobe light must be interconnected with smoke, heat and/or carbon monoxide alarms either within or nearby the sleeping rooms to provide protection.

## STROBE LIGHT OUTPUT FOR WALL & CEILING MOUNTING

The intensity of the strobe light gradually lessens as the angle increases. In other words, the light is brightest directly in front of the strobe light and is progressively less bright to either side. As required by Underwriters Laboratories Inc. (UL), the following illustrations show how the strobe light is dispersed. Use them to help you choose where to locate units for the hearing impaired.

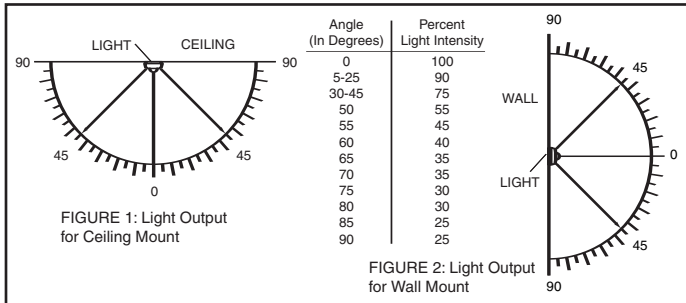

## PHOTOSENSITIVE EPILEPSY AND STROBE FLASH RATES

Individuals who are susceptible to photosensitive epilepsy might have an increased probability for seizures with multiple strobe lights flashing asynchronously. The frequency or speed of flashing light that is most likely to cause seizures varies from person to person. Generally, flashing lights most likely to trigger seizures are between the frequency of 5 to 30 flashes per second (Hertz). This strobe light flashes at about 1 flash per second.

Under the Americans with Disabilities Act, most workplaces and places serving the public, including theaters, restaurants, and recreation areas, are required to have fire alarms, which flash as well as ring so that people who cannot hear or cannot hear well will know that there is an emergency.

## WEEKLY TESTING

To test this strobe light you must activate the test button of each interconnected, smoke, CO or heat alarm. This will send a signal to the strobe light and cause the unit to begin flashing. Depending on what type of alarms you have connected, the strobe light will flash different patterns.

**Smoke/Heat Alarms:** Constant approximately 1 flash per second.  
**CO Alarms:** Intermittent approximately 1 flash per second for four flashes, then 5 seconds off. Pattern is repeated.

These different patterns are to help a hearing impaired person better distinguish the danger present. The flash patterns approximate the audible alarm emitted by either a smoke or heat alarm or a carbon monoxide alarm. Note that a heat alarm will emit the same horn pattern as a smoke alarm. Make sure all members of your family understand the different flash patterns.

**Do not look directly at or touch the lens while the strobe light is flashing. Doing so can hurt your eyes or burn your fingers.** If the strobe light does not flash during testing and the alarm does not sound, check the fuse or circuit breaker supplying power to the alarm circuit. If the alarm sounds and the strobe light does not flash, refer to the installation instructions in this manual to insure strobe light is wired properly. If the strobe light still does not work it should be replaced.

**When testing the interconnected alarm, do not stand too close to the unit when the alarm is sounding. It is loud to wake you in an emergency. Exposure to the horn at close range may harm your hearing.** All interconnected alarms connected to this strobe light must be tested individually to ensure proper connections. It is important to test all interconnected alarms every week to make sure they are working properly. Using the test button is the recommended way to test the alarms and strobe light.

## HOW TO INSTALL THIS STROBE LIGHT

This Strobe Light is designed to be mounted on any standard wiring junction box to a 4-inch (10 cm) diagonal size, on either the ceiling or wall (if allowed by local codes). Read "Recommended Placement for Hearing Impaired Strobe Lights" before you begin installation.

**Tools you will need:** • Standard Flathead screwdriver • Wire strippers

### THE PARTS OF THIS STROBE LIGHT

#### The Mounting Bracket

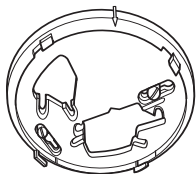

Installs onto the junction box. It has a variety of screw slots to fit most boxes. If a junction box is not already in place, install one using standard #12 or #14 gauge copper wire. To remove the mounting bracket from the base, hold the base firmly and twist mounting bracket counterclockwise.

#### The Power Connector

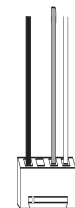

The power connector plugs into a power input block on the Strobe Light and supplies it AC power.

- Black wire is "hot."
- White wire is neutral.
- Orange wire is used for interconnect.

**If you need to remove the power connector, turn POWER OFF first.** To remove the power connector, insert a flat screwdriver blade between the power connector and the security tab inside the power input block. Gently pry back the tab and pull the connector free.

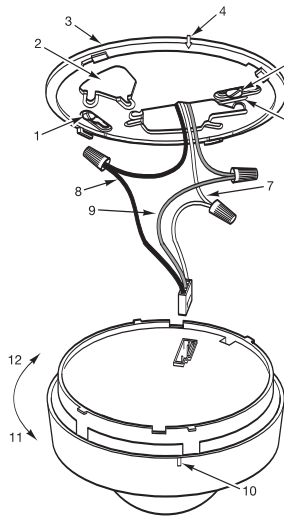

- 1 Mounting slot and screw (1 of 2)
- 2 Junction box
- 3 Mounting bracket
- 4 Mounting Bracket Alignment Arrow
- 5 Mounting slot and screw (1 of 2)
- 6 Wire strip gauge
- 7 Neutral (white) AC wire
- 8 Hot (black) AC wire
- 9 Interconnect wire
- 10 Alignment Tab On Alarm
- 11 Turn to attach to bracket
- 12 Turn to remove from bracket

**⚠WARNING!** Make sure the Alarm is not receiving excessively noisy power. Examples of noisy power could be major appliances on the same circuit, power from a generator or solar power, light dimmer on the same circuit or mounted near fluorescent lighting. Excessively noisy power may cause damage to your Alarm.

## FOLLOW THESE INSTALLATION STEPS

The basic installation of this strobe light is similar whether you want to install one strobe light or multiple strobe lights.

### ⚠ WARNING!

**This device is not a smoke, heat or CO alarm. It must be interconnected with operating alarms to provide protection. It will not work without AC power.**

Things to consider when planning the installation of a hearing impaired strobe light:

- Location of strobe light is important and must comply with NFPA 72 requirements. This device is intended to awaken a hearing impaired person and must be positioned properly for it to be effective. See Installation Diagram and "Recommended Locations for Hearing Impaired Strobe Lights" for details.
- Types of other alarms to be interconnected with this strobe light. This device can be interconnected with smoke, heat, carbon monoxide alarms or a combination of all three. A smoke alarm is usually placed within the sleeping room. A carbon monoxide or heat alarm is usually placed outside the sleeping area. Follow recommendations in each device's installation manual. The interconnect wire of all alarms must be properly connected for the strobe light to be operational. The strobe light may be positioned anywhere within the interconnected circuit.

### ⚠ DANGER!

**ELECTRICAL SHOCK HAZARD! Turn off power before starting installation!**

1. Remove the mounting bracket from the base. Install the mounting bracket to the junction box.
2. Using wire nuts, connect the power connector to the household wiring as follows:  
Strip off about 1/2" (12 mm) of the plastic coating on the orange wire on the power connector.
  - Connect the white wire on the power connector to the neutral wire in the junction box.
  - Connect the black wire on the power connector to the hot wire in the junction box.
  - Connect the orange wire on the power connector to the interconnect wire in the junction box. Repeat for each unit you are interconnecting. Never connect the hot or neutral wires in the junction box to the orange interconnect wire.
3. Plug the power connector into the back of the Strobe Light.
4. Line up the alignment tab on the base with the alignment tab on the mounting bracket. Turn the Strobe Light clockwise (right) until you hear the unit snap into place.
5. Check all connections.

### ⚠ WARNING!

**Improper wiring of the power connector or the wiring leading to the power connector will cause damage to the Strobe Light and may lead to a non-functioning unit.**

- If you are installing multiple Strobe Lights, repeat steps 1-5 for each Strobe Light in the series. When you are finished, restore power to the junction box.

### ⚠ DANGER!

**ELECTRICAL SHOCK HAZARD! Do not restore power until all devices are completely installed. Restoring power before installation is complete may result in serious electrical shock, injury or death.**

6. Make sure the Strobe Light is receiving AC power. Under normal operation, the green power indicator light will shine continuously. If the power indicator light does not light, TURN OFF POWER TO THE JUNCTION BOX and recheck all connections. If all connections are correct and the power indicator still does not light when you restore the power, the unit should be replaced immediately.

7. To test this strobe light you must activate the test button of each interconnected, smoke, CO or heat alarm. This will send a signal to the strobe light and cause the unit to begin flashing.

Depending on what type of alarms you have connected, the strobe light will flash different patterns.

Smoke/Heat Alarms: Constant approximately 1 flash per second.  
CO Alarms: Intermittent approximately 1 flash per second for four flashes, then 5 seconds off. Pattern is repeated.

These different patterns are to help a hearing impaired person better distinguish the danger present. The flash patterns approximate the audible alarm emitted by either a smoke/heat alarm or carbon monoxide alarm.

### ⚠ WARNING!

**Do not look directly at or touch the lens while the strobe light is flashing.**

### IMPORTANT!

If any Strobe Light does not flash, TURN OFF POWER and recheck connections. If any Strobe Light still does not flash when you test it after restoring power, replace it immediately.

This Strobe Light can be interconnected with all current model hardwired and ONELINK® wireless enabled **First Alert®** and **BRK Electronics®** branded Smoke Alarms, Carbon Monoxide Alarms, Combination Smoke/CO Alarms, Heat Alarms and relays. Call First Alert Consumer Affairs at 1-800-323-9005, 7:30 AM - 5:00 PM Central Standard Time, Monday through Friday for specific model information.

### IMPORTANT!

Interconnect units within a single family residence only, otherwise all households will experience unwanted alarms when you test any unit in the series. Interconnected units will only work if they are wired to compatible units and all requirements are met.

**Interconnected units must meet ALL of the following requirements:**

- A maximum of 18 units total may be interconnected (Maximum of 12 Smoke Alarms).
- The same fuse or circuit breaker must power all interconnected Alarms.
- The total length of wire interconnecting the units should be less than 1000 feet (305 meters). This type of wire is commonly available at Hardware and Electrical Supply stores.
- All wiring must conform to all local electrical codes and NFPA 70 (National Electrical Code). Refer to NFPA 72, NFPA 101, and/or your local building code for further connection requirements.

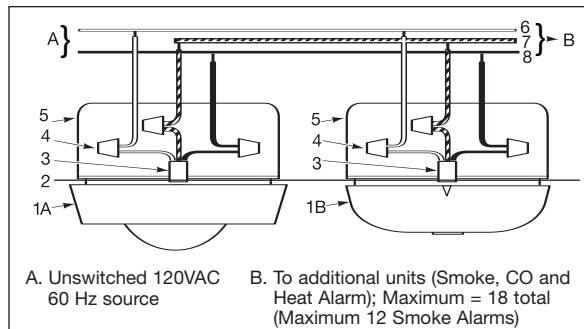

A. Unswitched 120VAC 60 Hz source  
 B. To additional units (Smoke, CO and Heat Alarm); Maximum = 18 total (Maximum 12 Smoke Alarms)

1A. Strobe Light	3. Power Connector	6. Neutral Wire (Wht)
1B. Smoke, CO or Heat Alarm	4. Wire Nut	7. Interconnect Wire
2. Ceiling or Wall	5. Junction Box	8. Hot Wire (Blk)

## REGULAR MAINTENANCE

This unit has been designed to be as maintenance free as possible, but there are a few simple things you must do to keep it working properly.

- Test it at least once a week.
- Clean the Strobe Light at least once a month; gently vacuum off any dust using your household vacuum's soft brush attachment, and test the Strobe Light after cleaning. Never use water, cleaners or solvents since they may damage the unit.

### ⚠ CAUTION!

- If the Strobe Light is loose or broken, the entire unit should be replaced immediately. Never remove the Strobe Light lens for any reason. Doing so can permanently damage the unit and will void your warranty.
- Do not paint over the unit. Paint may clog the openings and prevent the unit from operating properly.

## IF THIS STROBE LIGHT ACTIVATES

### RESPONDING TO AN ALARM

During an alarm, depending on what type of alarms you have connected, the strobe light will flash different patterns.

Smoke/Heat Alarms: Constant approximately 1 flash per second.  
CO Alarms: Intermittent approximately 1 flash per second for four flashes, then 5 seconds off. Pattern is repeated.

These different patterns are to help a hearing impaired person better distinguish the danger present. The flash patterns approximate the audible alarm emitted by either a smoke/heat alarm or carbon monoxide alarm.

The appropriate smoke, CO or heat alarm will also be sounding their repeating horn patterns:

Smoke or Heat Alarm you will hear 3 beeps, pause, 3 beeps, pause.  
Carbon Monoxide danger you will hear 4 fast beeps, pause, 4 fast beeps, pause.

## IF AN INTERCONNECTED CO ALARM SOUNDS

### “ALARM-MOVE TO FRESH AIR”

If you hear an interconnected CO alarm horn and the CO red light is flashing, move everyone to a source of fresh air. DO NOT remove the batteries!

### ⚠WARNING!

Actuation of an interconnected CO Alarm indicates the presence of carbon monoxide (CO) which can kill you. In other words, when your CO Alarm sounds, you must not ignore it!

### IF AN INTERCONNECTED CO ALARM SIGNAL SOUNDS:

1. Operate the Test/Silence button.
2. Call your emergency services, fire department or 911. Write down the number of your local emergency service here:  

---
3. Immediately move to fresh air—outdoors or by an open door or window. Do a head count to check that all persons are accounted for. Do not re-enter the premises, or move away from the open door or window until the emergency services responder has arrived, the premises have been aired out, and your CO Alarm remains in its normal condition.
4. After following steps 1-3, if your CO Alarm reactivates within a 24-hour period, repeat steps 1-3 and call a qualified appliance technician to investigate for sources of CO from fuel-burning equipment and appliances, and inspect for proper operation of this equipment. If problems are identified during this inspection have the equipment serviced immediately. Note any combustion equipment not inspected by the technician, and consult the manufacturers' instructions, or contact the manufacturers directly, for more information about CO safety and this equipment. Make sure that motor vehicles are not, and have not, been operating in an attached garage or adjacent to the residence. Write down the number of a qualified appliance technician here:  

---

**NOTE:** A qualified appliance technician is defined as “a person, firm, corporation, or company that either in person or through a representative, is engaged in and responsible for the installation, testing, servicing, or replacement of heating, ventilation, air conditioning (HVAC) equipment, combustion appliances and equipment, and/or gas fireplaces or other decorative combustion equipment.”

## IF AN INTERCONNECTED SMOKE ALARM SOUNDS

### RESPONDING TO AN ALARM

### ⚠WARNING!

- If an interconnected unit alarms and you are not testing the unit, it is warning you of a potentially dangerous situation that requires your immediate attention. NEVER ignore any alarm. Ignoring the alarm may result in injury or death.
- Never remove the batteries from a battery operated Smoke/CO Alarm to stop an unwanted alarm (caused by cooking smoke, etc.). Removing batteries disables the alarm so it cannot sense smoke, and removes your protection. Instead open a window or fan the smoke away from the unit. The alarm will reset automatically.
- If the unit alarms get everyone out of the house immediately.

### WHAT TO DO IN CASE OF FIRE

- Don't panic; stay calm. Follow your family escape plan.
- Get out of the house as quickly as possible. Don't stop to get dressed or collect anything.
- Feel doors with the back of your hand before opening them. If a door is cool, open it slowly. Don't open a hot door. Keep doors and windows closed, unless you must escape through them.
- Cover your nose and mouth with a cloth (preferably damp). Take short, shallow breaths.
- Meet at your planned meeting place outside your home, and do a head count to make sure everybody got out safely.
- Call the Fire Department as soon as possible from outside. Give your address, then your name.
- Never go back inside a burning building for any reason.
- Contact your Fire Department for ideas on making your home safer.

## IF YOU SUSPECT A PROBLEM

### ⚠CAUTION!

If the strobe light lens is loose or broken, the entire unit should be replaced immediately. Never remove the strobe light lens for any reason. Doing so can permanently damage the unit and will void your warranty.

### ⚠WARNING!

Always discharge the branch circuit before servicing an AC or AC/DC Alarm. First, turn off the AC power at the circuit breaker or fuse box. Next, remove the battery from Alarms with battery back-up. Finally, press and hold the test button for 5-10 seconds to discharge the branch circuit.

**Do not try fixing the device yourself – this will void your warranty!**

If the device is still not operating properly, and it is still under warranty, please see “How to Obtain Warranty Service” in the Limited Warranty.

## SPECIAL COMPLIANCE CONSIDERATIONS

### ⚠ WARNING!

Strobe Lights along with residential smoke and carbon monoxide alarms alone are not a suitable substitute for complete fire detection systems in places housing many people—like apartment buildings, condominiums, hotels, motels, dormitories, hospitals, long-term health care facilities, nursing homes, day care facilities, or group homes of any kind—even if they were once single-family homes. They are not a suitable substitute for complete fire detection systems in warehouses, industrial facilities, commercial buildings, and special-purpose non-residential buildings which require special fire detection and alarm systems, typically in only the sleeping areas. Depending on the building codes in your area, these devices may be used to provide additional protection in these facilities.

## LIMITATIONS OF STROBES

**Strobes and alarms may not waken all individuals.** Practice the escape plan at least twice a year, making sure that everyone is involved – from kids to grandparents. Allow children to master fire escape planning and practice before holding a fire drill at night when they are sleeping. If children or others do not readily waken to audible or visual signals, or if there are infants or family members with mobility limitations, make sure that someone is assigned to assist them in fire drill and in the event of an emergency. It is recommended that you hold a fire drill while family members are sleeping in order to determine their response while sleeping and to determine whether they may need assistance in the event of an emergency.

**The strobe cannot work without AC power.** The strobe will not operate if AC power is cut off for any reason (open fuse or circuit breaker, failure along a power line or at a power station, electrical fire that burns the electrical wires, etc.).

**The Strobe will not operate unless smoke, heat or CO reaches the corresponding alarm.** Refer to the user's manuals supplied with the interconnected smoke, heat or CO alarms.

**Strobes may not be seen.** Hearing impaired individuals may not see the visual notification if obstructions such as doors, walls, or bright lights block the strobe light. The use of alcohol or drugs may also impair ones ability to respond to the visual signal.

**Strobes are not foolproof.** Like any electronic device, strobes are made of components that can wear out or fail at any time. You must test the unit weekly to ensure your continued protection. Strobes are not a substitute for property or life insurance.

**Hearing deficits may not be not apparent.** If in doubt, consult your doctor.

**Strobes have a limited life.** The unit should be replaced immediately if it is not operating properly. Replace the strobe 10 years from date of installation.

## LIMITED WARRANTY

BRK Brands, Inc., ("BRK") the maker of BRK® brand and First Alert® brand products, warrants that for a period of ten years from the date of purchase, this product will be free from defects in material and workmanship. BRK, at its option, will repair or replace this product or any component of the product found to be defective during the warranty period. Replacement will be made with a new or remanufactured product or component. If the product is no longer available, replacement may be made with a similar product of equal or greater value. This is your exclusive warranty.

This warranty is valid for the original retail purchaser from the date of initial retail purchase and is not transferable. Keep the original sales receipt. Proof of purchase is required to obtain warranty performance. BRK dealers, service centers, or retail stores selling BRK products do not have the right to alter, modify or any way change the terms and conditions of this warranty.

This warranty does not cover normal wear of parts or damage resulting from any of the following: negligent use or misuse of the product, use on improper voltage or current, use contrary to the operating instructions, disassembly, repair or alteration by anyone other than BRK or an authorized service center. Further, the warranty does not cover Acts of God, such as fire, flood, hurricanes and tornadoes or any batteries that are included with this unit.

BRK shall not be liable for any incidental or consequential damages caused by the breach of any express or implied warranty. Except to the extent prohibited by applicable law, any implied warranty of merchantability or fitness for a particular purpose is limited in duration to the duration of the above warranty. Some states, provinces or jurisdictions do not allow the exclusion or limitation of incidental or consequential damages or limitations on how long an implied warranty lasts, so the above limitations or exclusion may not apply to you. This warranty gives you specific legal rights, and you may also have other rights that vary from state to state or province to province.

### How to Obtain Warranty Service

**Service:** If service is required, do not return the product to your retailer. In order to obtain warranty service, contact the Consumer Affairs Division at 1-800-323-9005, 7:30 AM - 5:00 PM Central Standard Time, Monday through Friday. To assist us in serving you, please have the model number and date of purchase available when calling.

**For Warranty Service return to:**  
BRK Brands, Inc.  
25 Spur Drive, El Paso, TX 79906

BRK® is a registered trademark of BRK Brands, Inc.  
First Alert® is a registered trademark of the First Alert Trust.