

*Owner's Guide
for the*



Ampeg

***SVT-GS Gene Simmons Punisher
Bass Amplifier***

*Unleash
The
Beast!*



Made in the U.S.A. by





Table of Contents

Introduction2
Features2
Important Safeguards and Precautions3
The Front Panel Controls and Their Use4
The Rear Panel5
Some Suggested Settings6
Troubleshooting7
System Block Diagram7
Tech Specsback cover

An introduction To Your Ampeg SVT-GS Gene Simmons Punisher Bass Amplifier

First of all, **thank you** for making what could be one of the best choices you could ever make concerning your musical career – choosing one of the best bass amps available, the Ampeg SVT-GS Gene Simmons Punisher. This powerhouse of an amplifier offers you many outstanding features: 350 watts of throbbing bass energy, total tone control, rugged construction, and the seal of approval of Mr. Gene Simmons himself!

Features





In the world of high performance bass amps, Ampeg's SVT amplifiers stand alone. In true Ampeg tradition, the SVT-GS Gene Simmons Punisher offers you more power, performance and flexibility than any other bass amp in its class. Below are some of the outstanding features of your new amplifier; features which set it (and you) apart from the competition!

- **9-BAND GRAPHIC EQ:** Use as a “second channel” for bass solos, or to shape your sound to your own exacting standards
- **BALANCED LINE OUTPUT:** XLR with independent level control switch to patch into house consoles, mixing boards, or external power amplifiers
- **EFFECTS LOOP:** For increased intensity and quieter operation of external effects
- **POWER AMP IN and PREAMP OUT:** Allows direct access into the power amp and a signal tap from the preamp section for even greater versatility
- **GENE SIMMONS PUNISHER GRAPHICS:** Inspired by one of Gene's “deadly weapons”
- **CLASSIC SVT SOUND AND PERFORMANCE:** Proudly Made In America!



All Ampeg products are designed for continuous safe operation, as long as common sense is used and steps are taken to help avoid certain problems. Abiding by the following rules can help prevent damage to your amplifier, yourself and others.

- The amplifier is equipped with a three-pronged AC power cord. To reduce the risk of electrical shock, **NEVER** remove or otherwise attempt to defeat the ground pin of the power cord.
- Connect the amplifier **ONLY** to a properly grounded AC outlet of the proper voltage for your amp.
- Avoid sudden temperature extremes, rain and moisture. Also, avoid sudden and intense impact. (If the unit has been subjected to any of the preceding abuses, have it looked at by an authorized service center.)
- **NEVER** set the amplifier on a support that might give out under its weight.
- Always keep the total speaker impedance at or above the rated load.
- Unplug the amplifier before cleaning it. **NEVER** spray liquid cleaners onto the amplifier. Wipe it with a slightly dampened, lint-free cloth to remove dirt and film.
- Don't use the amplifier if it has sustained damage to the chassis, controls, or power cord. Refer the unit to an authorized service center for inspection.
- Amplifiers capable of producing high volume levels are also capable of inflicting permanent hearing loss or damage, if the exposure to such levels is prolonged. Such damage is progressive and irreversible!

 <p>CAUTION RISK OF ELECTRIC SHOCK DO NOT OPEN</p> <p>CAUTION: TO REDUCE THE RISK OF ELECTRIC SHOCK, DO NOT REMOVE COVER. NO USER-SERVICEABLE PARTS INSIDE. REFER SERVICING TO QUALIFIED SERVICE PERSONNEL.</p>	 <p>ATTENTION RISQUE D'ELECTROCUTION NE PAS OUVRIR</p> <p>ATTENTION: POUR REDUIRE D'ELECTROCUTION NE PAS ENLEVER LE COUVERCLE. AUCUNE PIECE INTERNE N'EST REPARABLE PAR L'UTILISATEUR. POUR TOUTE REPARATION, S'ADRESSER A UN TECHNICIEN QUALIFIE.</p>	 <p>VORSICHT ELEKTRISCHE SCHLAGEFAHR NICHT OFFENEN</p> <p>VORSICHT: ZUR MINIMIERUNG ELEKTRISCHER SCHLAGEFAHR NICHT DEN DECKEL ABENHMEN. INTERNE TEILE KONNEN NICHT VOM BENUTZER GEWARTET WERDEN. DIE WARTUNG IS QUALIFIZIERTEM WARTUNGSPERSONAL ZU UBERLASSEN.</p>																								
<p>THIS EQUIPMENT HAS BEEN DESIGNED AND ENGINEERED TO PROVIDE SAFE AND RELIABLE OPERATION. IN ORDER TO PROLONG THE LIFE OF THE UNIT AND PREVENT ACCIDENTAL DAMAGES OR INJURY, PLEASE FOLLOW THESE PRECAUTIONARY GUIDELINES:</p> <p>WARNING: TO REDUCE THE RISK OF ELECTRIC SHOCK, DO NOT OPEN CHASSIS; DO NOT DEFEAT OR REMOVE THE GROUND PIN OF THE POWER CORD; CONNECT ONLY TO A PROPERLY GROUNDED AC POWER OUTLET.</p> <p>CAUTION: TO REDUCE THE RISK OF FIRE OR ELECTRIC SHOCK, DO NOT EXPOSE THIS EQUIPMENT TO RAIN OR MOISTURE.</p> <p>CAUTION: NO USER-SERVICEABLE PARTS INSIDE. REFER SERVICING TO QUALIFIED SERVICE PERSONNEL.</p> <p>CAUTION: OUR AMPLIFIERS ARE CAPABLE OF PRODUCING HIGH SOUND PRESSURE LEVELS. CONTINUED EXPOSURE TO HIGH SOUND PRESSURE LEVELS CAN CAUSE PERMANENT HEARING IMPAIRMENT OR LOSS. USER CAUTION IS ADVISED AND EAR PROTECTION IS RECOMMENDED IF UNIT IS OPERATED AT HIGH VOLUME. The chart below shows the U.S. Government Occupational Safety and Health Administration (OSHA) regulations which were in effect at the time of this publication for permissible noise exposure, per 29CRF1910, Table G-16.</p>																										
<table border="1" style="width: 100%; border-collapse: collapse;"> <thead> <tr> <th style="width: 25%;">SOUND LEVEL dBA SLOW RESPONSE</th> <th style="width: 25%;">DURATION PER DAY IN HOURS</th> <th style="width: 25%;">SOUND LEVEL dBA SLOW RESPONSE</th> <th style="width: 25%;">DURATION PER DAY IN HOURS</th> </tr> </thead> <tbody> <tr> <td>90</td> <td>8</td> <td>102</td> <td>1-1/2</td> </tr> <tr> <td>92</td> <td>6</td> <td>105</td> <td>1</td> </tr> <tr> <td>95</td> <td>4</td> <td>110</td> <td>1/2</td> </tr> <tr> <td>97</td> <td>3</td> <td>115</td> <td>1/4 or less</td> </tr> <tr> <td>100</td> <td>2</td> <td></td> <td></td> </tr> </tbody> </table>			SOUND LEVEL dBA SLOW RESPONSE	DURATION PER DAY IN HOURS	SOUND LEVEL dBA SLOW RESPONSE	DURATION PER DAY IN HOURS	90	8	102	1-1/2	92	6	105	1	95	4	110	1/2	97	3	115	1/4 or less	100	2		
SOUND LEVEL dBA SLOW RESPONSE	DURATION PER DAY IN HOURS	SOUND LEVEL dBA SLOW RESPONSE	DURATION PER DAY IN HOURS																							
90	8	102	1-1/2																							
92	6	105	1																							
95	4	110	1/2																							
97	3	115	1/4 or less																							
100	2																									
<p>According to OSHA, any exposure in excess of those listed above could result in some hearing loss.</p>																										
<p>EXPLANATION OF GRAPHICAL SYMBOLS:</p> <p> = "DANGEROUS VOLTAGE" "DANGER HAUTE TENSION" "GEFAHLICHE SPANNUNG"</p> <p> = "IT IS NECESSARY FOR THE USER TO REFER TO THE INSTRUCTION MANUAL" "REFERREZ-VOUS AU MANUAL D'UTILISATION" "UNBEDINGT IN DER BEDIENUNGSANLEITUNG NACHSCHLAGEN"</p>																										

Ampeg SVT-GS Gene Simmons Punisher

The Front Panel Controls and Their Use

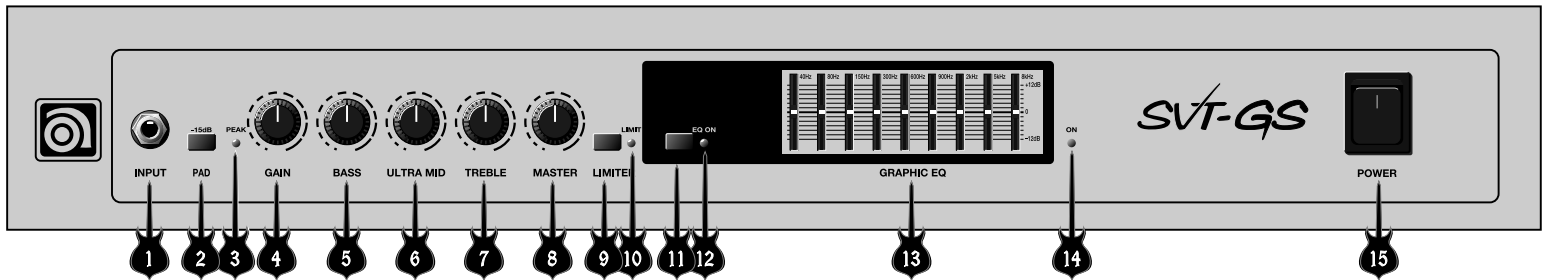

1. INPUT: Connect your bass here using a standard shielded instrument cable.

2. 15dB PAD: When engaged, this switch cuts the input signal level by 15dB, allowing you to set the Gain control (#4) for the best signal to noise ratio. (If your bass has high-output pickups or active electronics, you should use the Pad.)

3. PEAK LED: This LED lights whenever any preamp stage is near clipping. Adjust the Gain control (#4) until a strong signal from your bass causes this LED to flicker.

4. GAIN: This serves as the input level control for the amplifier. For the best signal to noise ratio, set this control so the Peak LED (#3) flashes when you hit your strings hard.

NOTE: If the Peak LED stays on with the Gain at a low setting, use the 15dB pad (#2) to cut the input signal, then readjust the Gain.

5. BASS: The primary low frequency control. This knob allows for a range of 8dB of cut or boost at 50Hz.

6. ULTRA-MID: The primary midrange control. Rotate the knob to the left of center for a “contoured” sound (more distant, less midrange output) or to the right of center for a sound which really cuts through.

7. TREBLE: The primary high frequency control. This knob allows for a range of 12dB boost or 19dB of cut at 5kHz.

8. MASTER: Set the overall output level of the amplifier with this control. The Effects Loop and Balanced Out (#22-26) are *not* affected by the Master control.

9. LIMITER SWITCH: The amplifier uses an internal Optocoupler Limiter to help keep the power amp’s output “clean” at extreme volume levels. (All amplifiers may begin to clip their output signals as they approach maximum output levels, resulting in potentially damaging distortion.) To engage the Limiter, press in the Limit switch. Playing at full power with the Limiter off will give you increased output power, but the sound may be distorted. Use discretion when playing without the Limiter.

10. LIMIT LED: This LED will flash any time the internal limiter circuit is called upon to keep the amplifier’s output signal clean. This shows that the amplifier is nearing full output and the limiter is keeping it from clipping the output signal.

11. EQ ON SWITCH: Press this switch IN to activate the Graphic EQ.

12. EQ ON LED: This LED lights when the Graphic EQ is active.

13. GRAPHIC EQ: These slide controls allow you to adjust the output of the frequencies shown above each control. The center position of each control is flat (no boost or cut).

14. POWER ON LED: This LED lights when the POWER switch (#15) is ON.

15. POWER SWITCH: This heavy-duty rocker switch applies the power to the amplifier: the amp is ON in the up position, OFF in the down position.

Ampeg SVT-GS Gene Simmons Punisher

The Rear Panel

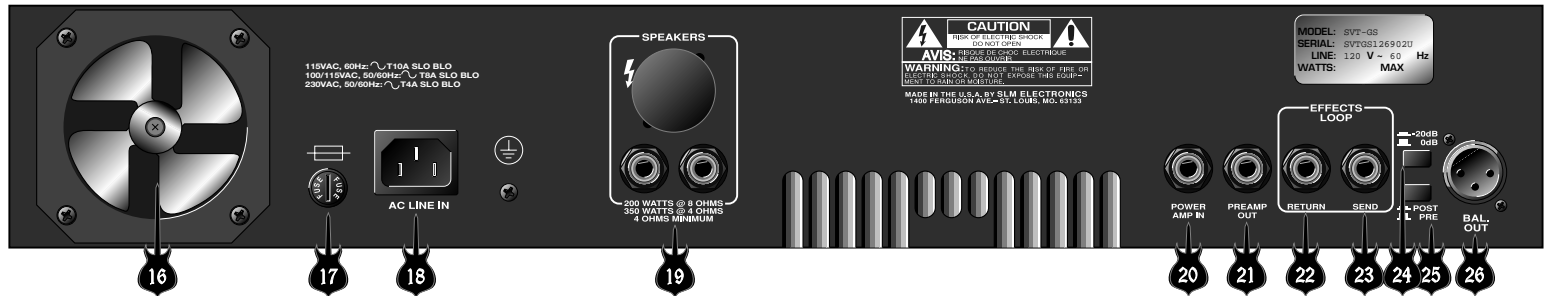

16. FAN: This temperature controlled, variable speed fan draws cool air into the amplifier, forcing heat out through the exhaust vents (also on the rear panel, between the speaker jacks and the power amp in jack). Never block the vent holes or the fan openings.

NOTE: It is not uncommon for the fan to remain off when the amplifier is first powered up.

17. FUSE: This protects the unit from damage due to overload conditions or power line surges. If the fuse blows, replace it only with the same size and type.

18. AC LINE IN: Firmly plug the supplied AC power cord into this socket, pushing it in until it is fully seated. Plug the male end of the cord into a grounded AC outlet. **DO NOT DEFEAT THE GROUND PRONG OF THE AC PLUG!**

19. SPEAKER OUTPUTS: Use these jacks to connect the amplifier to your speaker(s) using cables terminated with 1/4" plugs. Always use high-quality speaker cables for these connections.

NOTE: When connecting multiple speaker cabinets to the amplifier, keep the overall impedance at or above four ohms! The following chart shows the total impedance load when connecting speaker cabinets in parallel:

Cabinet Impedance	# of Cabs	Total Impedance
8Ω	2	4Ω
16Ω	2	8Ω
16Ω	4	4Ω

20. POWER AMP IN: This mono jack allows you to feed the preamp output of another amplifier to the input of the internal power amp. This disconnects the SVT's preamp.

21. PREAMP OUT: A post-EQ signal may be taken from this jack to be sent to the house mixing board, recording console or external power amplifier.

22. EFFECTS RETURN: To use an external effects device, connect the OUTPUT of the device to the Return jack using a shielded cable. This feeds the processed signal into the amp's Master section.

23. EFFECTS SEND: Connect the output from the Send jack to the INPUT of your effects using shielded cable. This sends a post-EQ signal to your effects.

24. -20dB SWITCH : This control adjusts the output level at the Balanced Line Output jack (#26). The control works independently from the front panel Master control. Pushing the switch in activates the -20dB pad, allowing use of microphone inputs on a mixer without overdriving the inputs.

25. PRE/POST SWITCH: You can select either Pre or Post EQ for the signal at the Balanced Out jack (#26) with this switch. With the switch in the OUT position, the signal at the jacks will be Pre-EQ. This is a direct output not affected by any EQ or boost settings. With the switch in, the signal is Post-EQ and is controlled and modified by the tone controls, Graphic EQ, and Effects Loop.

26. BALANCED OUTPUT: This XLR-type connector supplies a balanced preamp output signal for connecting to a house mixing board, recording console or external amplifiers with balanced inputs. The signal can be set to Pre or Post EQ by the back panel Pre/Post switch (#25). The level can be adjusted for either mic or line type inputs using the -20dB switch (#24).

IMPORTANT NOTE ABOUT CERTAIN EXPORT UNITS: In some areas 1/4" speaker jacks are not acceptable for use on amplifiers capable of high output power levels. For this reason the Speaker jacks on your amplifier may resemble the illustration to the right. Connect the amplifier to your speaker(s) using cables rated for very high output power, terminated with the appropriate connectors.



Ampeg SVT-GS Gene Simmons Punisher

Some Suggested Settings

The setting of the Gain and Master controls depend on your bass, on your playing style, and on how loud you want it! The Graphic EQ can be used to compensate for room acoustics, to "fine tune" your sound, and as a "second channel" to be kicked in when needed for solos and riffs.

ROCK:

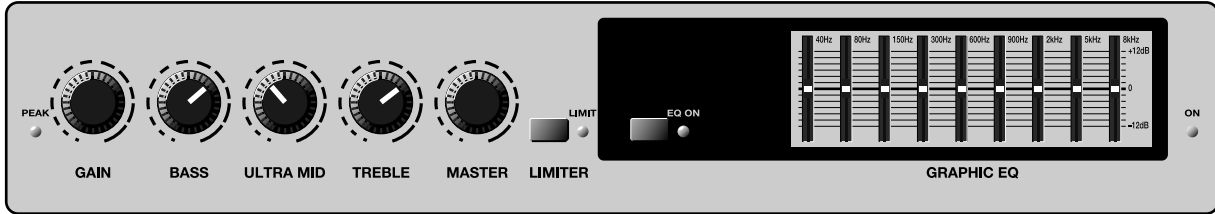

JAZZ:

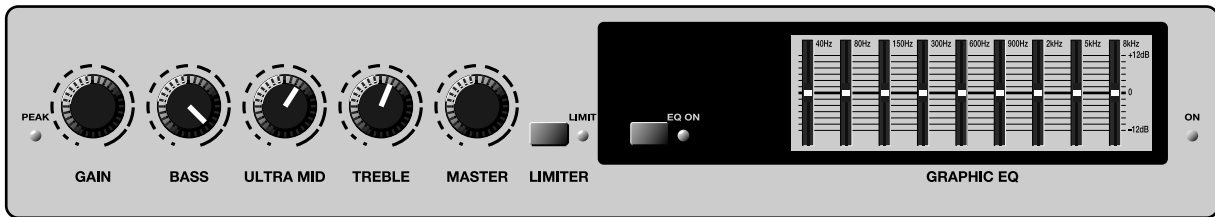

COUNTRY:

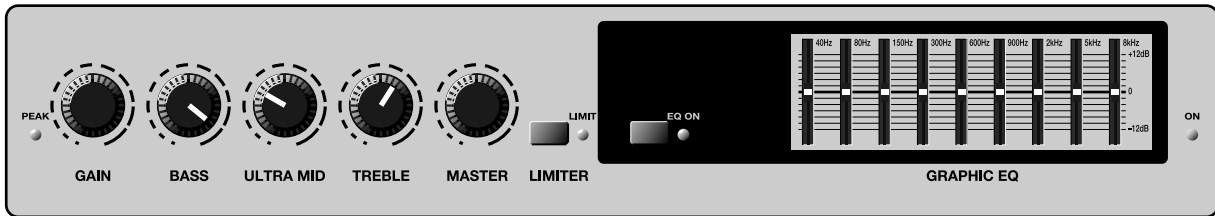

FUNK "POPPING:"

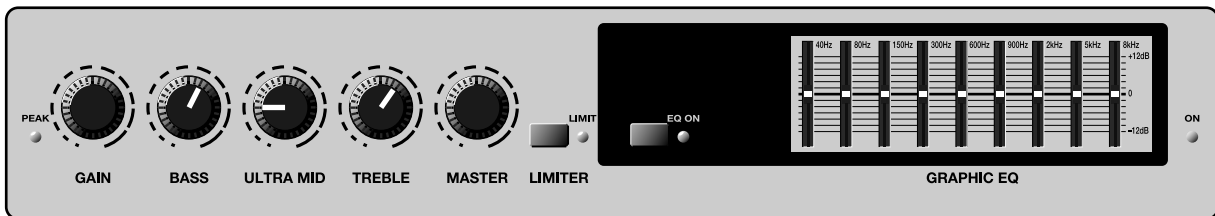

Troubleshooting

In the unlikely event that your SVT-GS Gene Simmons Punisher should stop working properly (or just stop working), take a few minutes to troubleshoot it before you call for service. You can save yourself a lot of time and sometimes money by doing it yourself, and often the cure for the problem is something quite simple.

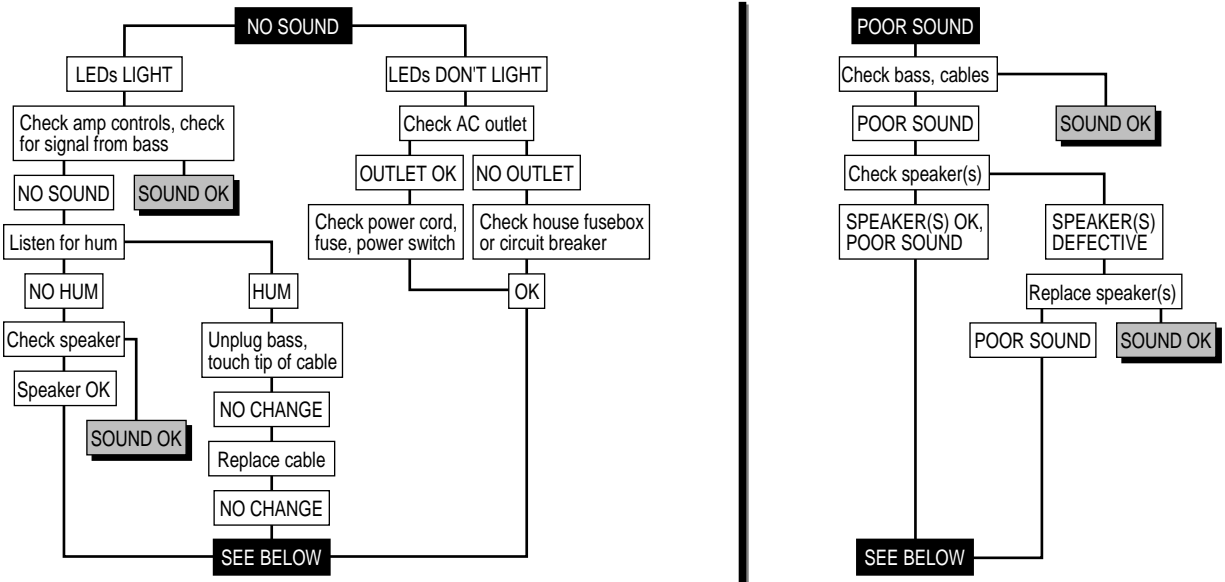

If the problem isn't covered above, or if the steps led you here, then contact your Ampeg dealer for service information. Also, you should refer your amp for servicing if it gets dropped, has liquid spilled into it, or sustains damage to its power cord.

System Block Diagram

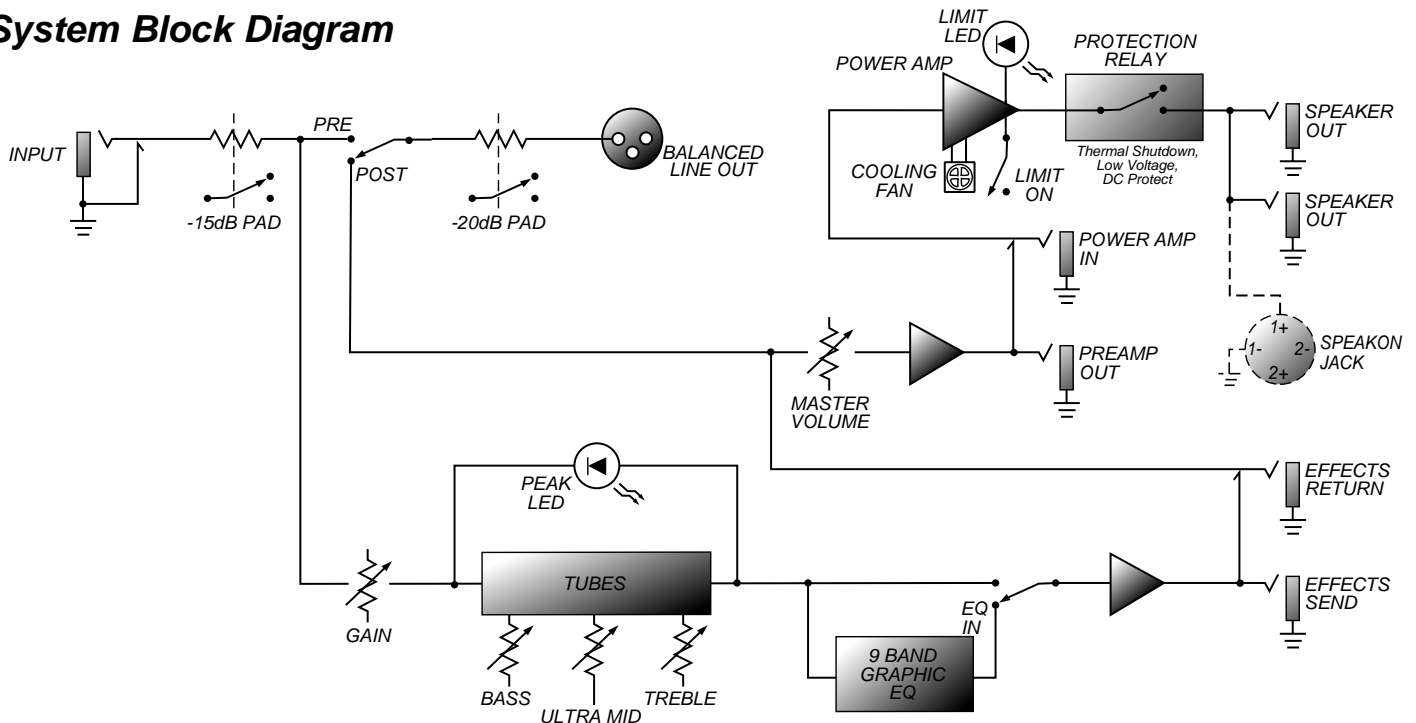



OUTPUT POWER RATING	350 Watts RMS, 4 ohm load, 120VAC
	200 Watts RMS, 8 ohm load, 120VAC

POWER REQUIREMENTS

Domestic:	115VAC, 60Hz, 205VA
Export:	100/115VAC, 50/60Hz, 205VA
	230VAC, 50/60Hz, 205VA

TONE CONTROL RANGE

Bass:	±8dB @ 50Hz
Ultra Mid:	±8dB @ 500Hz
Treble:	+12dB/-19dB @ 5kHz

GRAPHIC EQ RANGE

40Hz:	±11dB
80Hz:	±8dB
150Hz:	±8dB
300Hz:	±8dB
600Hz:	±8dB
900Hz:	±8dB
2kHz:	±8dB
5kHz:	±9dB
9kHz:	±12dB

GAIN	45dB typical, tones @ center
-------------	------------------------------

SIGNAL TO NOISE RATIO	75dB typical
------------------------------	--------------

SIZE AND WEIGHT	24"W x 11.5"H x 13"D, 44 lbs.
------------------------	-------------------------------



Ampeg reserves the right to change specifications without notice.

