



Designed for the real world

Instructions



WD865
WD860

Congratulations on choosing Ultima!!



Please record the Model number and the Serial number of your machine on the Back Cover of the book for future reference. The Model number can be found on the control panel. The Serial number can be found on the inner door trim.

Front adjustable feet

Interlocking door and release lever

Cold water inlet point and attached fill hose (blue connector)

Hot water inlet point and attached fill hose (red connector)

Mains cable

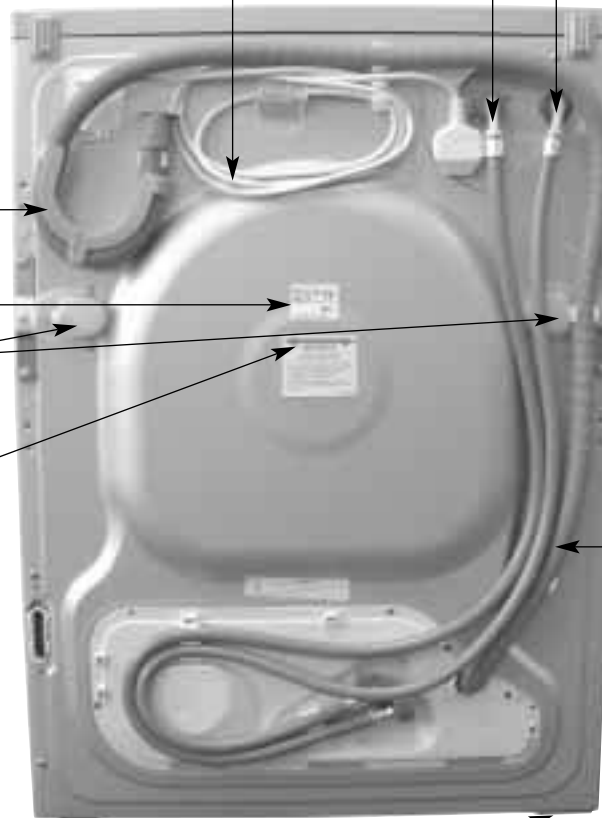

Hooked end support

Rating plate

Transit bolts (both must be removed before use)

Plumbing Indicator Line label

Drainage hose

Rear feet

The following instructions and information will help you to get the most out of your new machine...

Safety first!

This instruction manual contains important details on using your machine safely. If you pass the machine onto someone else, make sure that you give them this manual.

Page 4

SAFETY

Installing your machine

Follow these steps for trouble free installation: location, transit bolt removal, electricity, water supplies and drainage. Moving the machine and adjusting the feet.

Pages 5-10

INSTALLING YOUR MACHINE

A typical wash and dry programme

Washcare tips and a simple step by step guide to using your machine.

Pages 11-12

ATYPICAL WASH & DRY PROGRAMME

The dispenser drawer

Guidance on getting the most out of your wash using powders, liquids, tablets and fabric conditioners.

Pages 13-14

THE DISPENSER DRAWER

Programmes, options and other features

Select a programme for any wash and/or dry, including automatic functions, pre-washes, economy loads, variable temperature and spin speeds.

Pages 15-24

PROGRAMMES AND OPTIONS

Cleaning and maintenance

How to care for your machine by removing and cleaning the dispenser drawer and compartments, cleaning the door bowl and machine exterior plus the recommended Maintenance wash.

Page 25

CLEANING & MAINTENANCE

Troubleshooting

In the unlikely event that you have problems with your machine, the following guide may help you to get your machine working correctly straight away.

Pages 26-27

TROUBLE SHOOTING

After sales service and guarantee

We give you a unique 'satisfaction guaranteed' promise - valid for ninety days after you have purchased your machine.

Pages 28-29

SERVICE & GUARANTEE

Safety first

This instruction manual contains important details on using your machine safely. Please keep it safe for your future reference.

If you pass the machine onto someone else, please make sure that you give them this manual so that the new owner can read these safety warnings.



- **Dispose of packaging materials carefully and keep them well away from children.**
- **When disposing of your old machine, to minimise risk of injury to children, isolate from the electrical supply, remove the door, the plug and cut the mains cable off flush with the appliance. Dispose of them separately to make sure that the appliance can no longer be plugged into a mains socket.**
- **This washer dryer is designed for domestic use only.**
- **Before using your machine remove the transit bolts and spacers from the back of the machine. Keep the parts you remove for future transportation.**
- **Any electrical work necessary to install this machine should be carried out by a qualified electrician.**



- **Do not plug your machine into a socket when your hands are wet.**
- **Do not connect the washer dryer to a single outlet instantaneous water heater.**
- **Do not try to modify this machine in any way.**
- **Do not connect the washer dryer directly to an artificial water softening unit. Use the recommended amount of detergent for the water hardness in your area.**
- **Do not let children play with the machine or its controls.**
- **Do not stand on the machine or in the door opening.**
- **Do not lean on the door or use the door to lift or move the machine.**
- **Do not wash or dry garments that have previously been treated with solvents.**

Remove the polystyrene base...

Important check when unpacking your machine:

This is part of the polystyrene base and should have stayed intact when you remove the base.

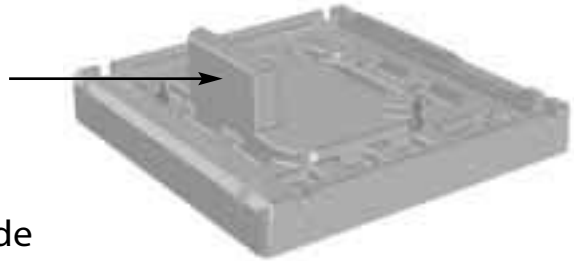

If it has broken off and is still in the machine... to remove it, carefully lay the machine on its side onto the polystyrene top cap and then remove the polystyrene block.

Note: You will need a second person to help you lower and raise the machine.

Installing your machine

Follow these steps for trouble free installation:

1. Choose a location...

Where you install the machine will affect its performance.

- For your safety and to comply with electrical regulations, seek professional advice if you want to install your machine in a bath or shower room.
- Make sure that the electrical socket and water taps are easily accessible. You should switch off the machine's electrical and water supplies when you are not using it.
- Make sure that you allow enough space for the machine. Select a space at least 600mm wide, 600mm deep and 850mm high. Also leave enough space to open the door fully so you can load and unload it easily.
- Where possible the machine should be positioned on a solid level floor to minimise vibration.
- Take care when you move the machine not to rip any floor coverings. There are wheels on the bottom rear of the machine, so tilting it backwards a little is the easiest way to move it. The weight of the machine may cause indentations in some floor coverings.

WARNINGS:

- Do not plug the machine in and switch it on at the mains until the installation is completed.
- You will be charged for a service call if a problem with your machine is caused by incorrect installation or misuse.

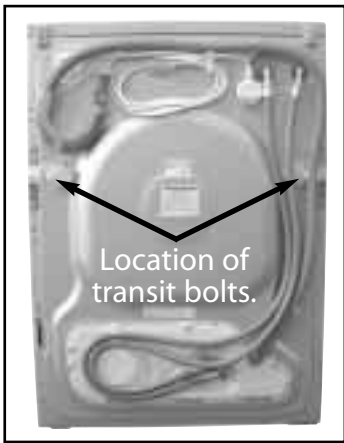

2. Remove the transit fixings...

There are **two** transit bolts fitted under plastic covers, one at either side of the rear of your machine. These bolts prevent damage to the machine while it is being transported. Remove both transit bolts complete with spacers, by following the instructions below.

Use a screwdriver to release the covers and a standard 13mm spanner to remove **both** bolts.

WARNINGS:

- Before you use the machine, remove the two transit bolts complete with spacers. If you do not do this, damage may occur to your machine. Keep the parts in case you need them for future transportation.

- If and when you replace the bolts complete with spacers make sure you do not overtighten them.

Firstly, unhook the grey drainage hose and proceed as follows, taking care not to loosen the hot and cold water fill hoses.



Using a screwdriver, remove the screw to release the plastic cover.

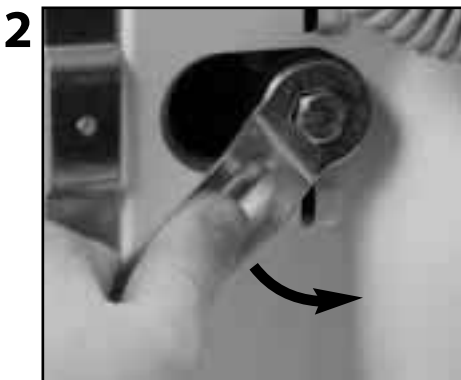

Use a standard 13mm spanner to undo the bolt until three threads can be seen on the bolt. (see below)

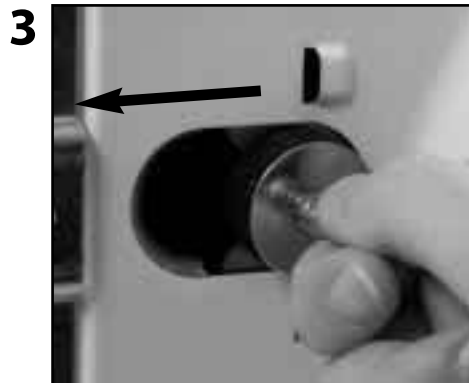

Hold the transit bolt and slide to the side and then pull out. The bolt and spacer should be removed intact. (see below)

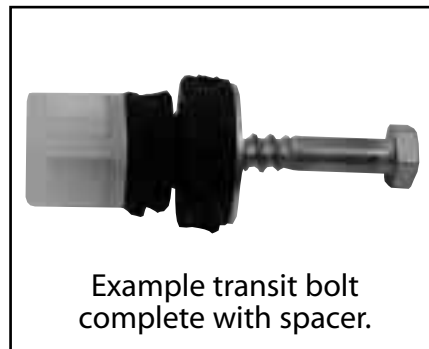

For **safety**, you must replace the plastic cover over the hole left by the transit bolt.

(Repeat steps 1 to 4 to remove the second transit bolt).

3. Connect your machine to the electricity supply

Make sure that the electrical socket is accessible. Take the mains lead from the back of the machine and plug it into the socket. We do not recommend wiring your machine directly into the mains supply.

Changing the mains lead

If you have damaged the existing lead and need a new one, contact Hotpoint Service UK on 08709 066066 or www.theservicecentre.co.uk (or in the Republic of Ireland on 1850 302 200). A charge will be made. We strongly advise that fitting the new lead is carried out by a qualified electrician.

Changing the plug

If you need to change your plug, ie. if it does not fit your socket; isolate the machine from the mains supply. Cut off the supplied plug and safely dispose of the discarded plug.

Note: If you change the plug, the colour of wires in the mains lead may not match the colour of the markings which show the different terminals in the plug. You must wire it as shown below.

Green and yellow

(Earth) wire this to the terminal marked 'E', ⊕ symbol, or coloured green and yellow.

Blue (Neutral)

wire this to the terminal marked 'N' or coloured black.

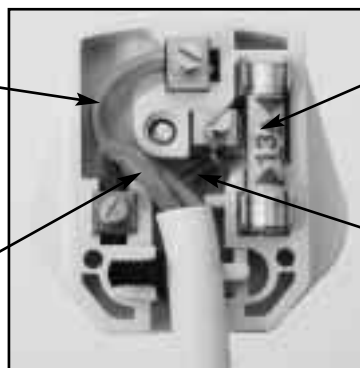

13A ASTA approved fuse to BS1362.

Brown (Live)

wire this to the terminal marked 'L' or coloured red.

Fuses

Your machine comes fitted with a plug and a 13 amp (13A) fuse. If you need to replace the fuse, use only those rated at 13 amp (13A) and ASTA approved to BS1362. To change the fuse, lift the holder to vertical position and lift the fuse out. To replace the fuse, insert the fuse and push the fuse holder down into the locked position. Correct replacement is identified by colour coding or the marking on the base of plug.

WARNING:

Do not use the plug unless the fuse holder is in the locked position and the top cover firmly replaced.

We do not recommend the use of extension leads. If you need to do so, consult a qualified electrician.



CE marking shows that this machine meets the following EEC directives.

Low Voltage Equipment - 72/23/EEC & 93/68/EEC

Electromagnetic Compatibility - 89/336/EEC, 92/31/EEC & 93/68/EEC.

WARNINGS:

- This machine must be earthed.
- Do not use the plug unless the fuse cover is fitted.
- To avoid a shock hazard, when changing a plug, always safely discard the cut off plug. Do not insert into any other socket.
- Seek professional advice if you need to use an extension lead.

4. Connect your machine to the water supply...

WARNINGS:

- The temperature of your hot water supply should ideally be 60°C and no higher than 70°C as this could cause damage to your laundry and the machine.
- Do not connect the machine to a single outlet instantaneous water heater.

- Your hot and cold water pressure must be in the range Max. 1Mpa (10 bar) and Min. 0.05Mpa (0.5 bar). **Incorrect pressures could lead to flooding.**
- The water supply taps should be accessible when the machine is installed.
- Before connecting the fill hoses, check that water is running from the water supply taps you will use for your machine.
- Connect the machine to the water supply using the fill hoses fitted to the machine. Do not use old hoses.

Hot and cold fill

- 1 Unclip both of the fill hoses from the back of the machine.
- 2 Connect the free end of the grey fill hose with the red connector to the HOT water supply (see figure 1). Connect the free end of the grey fill hose with the blue connector to the COLD water supply.
- 3 Turn on your water supply and check for leaks. If there is a leak, turn off the water supply, remove the connector and check that the sealing washer is in place. Refit the connector and tighten it. Turn on the water supply.
- 4 When moving the machine into its final position, make sure that the hoses are not trapped or kinked.

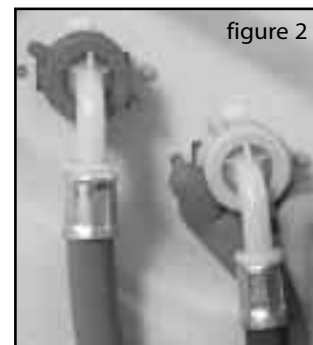
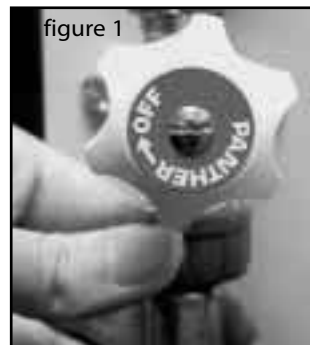

If the fill hoses are too short:

Longer fill hoses are available from our Genuine Parts and Accessories Mail Order Hotline UK on 08709 077 077 or www.theservicecentre.co.uk (or in the Republic of Ireland on (01) 842 6836).

Remove the existing fill hoses from the inlet valves on the back of the machine and fit the new longer fill hoses as shown above with the angled ends of the hoses connected to the machine (see figure 2).

If you have no hot water supply or your hot water pressure is low:

A cold fill adaptor (figure 3) and fitting instructions are available from your local Hotpoint authorised Service Centre or by calling the Genuine Parts and Accessories Mail Order Hotline UK on 08709 077 077 or www.theservicecentre.co.uk (or in the Republic of Ireland on (01) 842 6836).

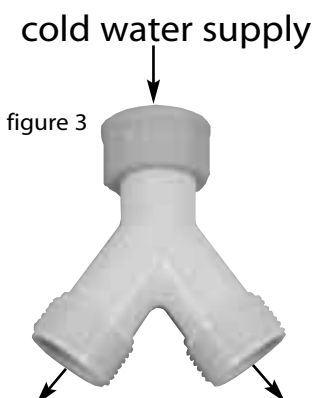

5. Connect the machine to a drainage system...

- Take care when you remove the drain hose from the clips on the back of the machine. All machines are tested with water before they leave the factory so a small amount of water may still be in the hose.
- Do not remove the hooked end support from the GREY drainage hose when using any of the drainage methods detailed below. You may need to reposition it as required along the drainage hose.
- For drainage into a standard work top sink, ensure the outlet pipe has a minimum diameter of **32mm**. If your sink is inset, the front edge of the basin must be less than **75mm** from the front edge of your worktop, so that the drain hose will hook securely into the sink. Unclip the drainage hose from the back of the machine and hook over into the sink. Make sure that the sink is free of any obstructions and that the sink plug can not fall into the sink, preventing the water from draining away freely. Pumped out water may be very hot.



We recommend one of the following drainage methods:

Standpipe

- 1 Make sure that the standpipe has a minimum diameter of 38mm.
- 2 Remove the drainage hose from the clips on the back of the machine.
- 3 Make sure that the top of the standpipe is positioned at least **500mm** from the floor (see figure 1). Use the plumbing indicator line label on the back of the machine as a guide.
- 4 Place the drainage hose approximately 100mm into the standpipe.

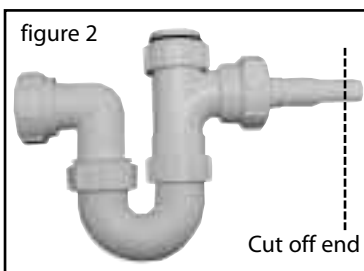

Under sink waste system

- 1 Cut out the membrane, bung or blanking plug (see figure 2).
- 2 Unclip the drainage hose from the back of the machine.
- 3 Move the hooked end support along the drainage hose as required.
- 4 Attach the drainage hose securely to the under sink drainage unit, using a hose clip (see figure 3).
- 5 Raise the hooked end support up to at least **800mm** to avoid water being drawn back into the machine.



If the GREY drainage hose is too short

A longer drainage hose is available from our Genuine Parts & Accessories Mail Order Hotline
UK on 08709 077 077 or www.theservicecentre.co.uk
(or in the Republic of Ireland on (01) 842 6836).

WARNINGS:

- Take care when using the sink drainage system. The discharge water may be very hot.
- Do not position the standpipe near an electrical socket.
- Flooding could occur if any part of the installation is not carried out correctly.
- Remember you will be charged for a service call for problems caused by incorrect installation, non-removal of transit bolts or packaging, leaks from household pipework, loose or blocked fill and drain hoses.

6. Move the machine into position...

WARNING:

- Do not drag or lift the machine by its door.

Your machine is heavy so care must be taken when moving it.

- Please take care not to damage any floor coverings when moving the machine.
- When moving the machine, take care not to kink or damage the hoses at the back of machine.

7. Adjust the feet...

Once the machine is in place

Your machine may become noisy or move about if it is not level. If necessary, to level the machine adjust the two front feet, as follows:

- When your machine is in its intended location, make sure that it is level by turning one or both of the front feet clockwise until the machine stands firm and level.
The maximum slope of the table top must not exceed 2°.



- The spring on each foot will stop them coming loose.
- Switch the machine on at the plug socket.

Now that you have successfully installed your new machine, we advise that you run it through a 95° White Cotton programme without any laundry and without any detergent in it. This will check your installation, connections and drainage, and will thoroughly clean the interior before you carry out an actual wash programme on your laundry. **NOTE:** This will take approximately 2 hours to complete.

Continue reading this book to get to know the various features of the machine.

TECHNICAL DETAILS	
Models	WD865, WD860
Dimensions	59.5cm wide 85cm high 60cm deep
Capacity	from 1 to 6kg Wash from 1 to 5kg Dry
Electric Connections	voltage 220/230 Volts 50Hz maximum absorbed power 1700W
Spin Speed	up to 1600rpm
Control programmes according to IEC50229 directive	Cotton wash temperature 60°C Wash run with a 6kg load Dry run with a 1kg load followed by a 5kg load

Using your machine

The rest of this instruction book will help you to make the most of your new washer dryer. We have created the machine for the way you live, by listening to people just like you who use our products. You will find that your new machine has many useful features and is easy to use.

Washcare tips...

- Your machine can wash a maximum load of 6kg (cotton) and dry a maximum load of 5kg.
- Do not overload the machine (maximum load 6kg). In addition to reducing the quality of the wash, this may also damage your laundry and the machine.
- We strongly recommend that you do not wash **underwired bras** in this machine. Should the wires become detached it could cause damage to your clothes and the machine. If the washcare label states that the bra is machine washable, then we advise placing it in a sealed pillow case or a similar washbag.
- Do not use the machine if the item to be washed does not have a wash label.

Before washing laundry we recommend that you do the following:

- Pre-treat awkward stains with washable treatments. Do not wash any items that have previously been treated with solvents.
- Close zips, fasten belts, tie strings and close press studs to prevent tangling.
- Empty all objects from pockets as they may damage clothes and the machine.
- Limit the size of absorbent loads, for example towels to 3kg (7lb) to give good washing and rinsing results.
- Place small items in a wash bag.
- Always follow the care label on items when choosing a wash programme.
- Wash non-colourfast items or really dirty clothes separately as they may affect other items.

Weight of Wash Load

Two examples of maximum wash loads for different types of fabric.

COTTON
2 Bath Towels
1 Hand Towel
6 Shirts
6 Blouses
1 pair of Pyjamas
4 items of Underwear

= 6kg

SYNTHETIC
2 Children's Dresses
4 Shirts
4 Blouses
1 pair of Pyjamas
4 items of Underwear



= 3kg

A typical wash & dry programme

WARNINGS:

- Do not allow children to play with the machine or tamper with the controls. This machine has a Child Lock feature, which when activated disables all controls (see 'Options').
- Do not overload the machine! It may damage laundry and reduce the quality of the wash.
- Do not try to open the door when a programme is running.
- Do not open the dispenser drawer during any programme.
- In the unlikely event of something not working see the Troubleshooting section.

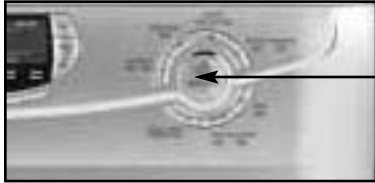
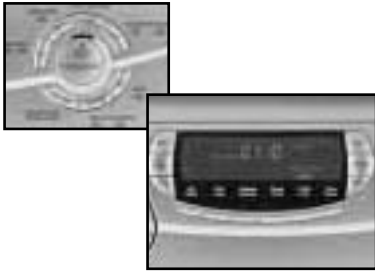
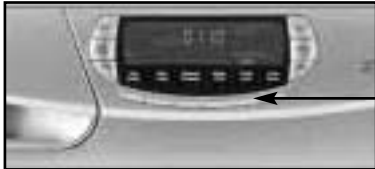
ATYPICAL WASH & DRY PROGRAMME

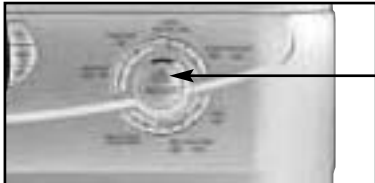
- 1 Sort your laundry into groups with the same wash and dry care labels. Load the machine, making sure that clothes are not trapped in the door. Close the washing machine door by pushing it until it clicks.
- 2 Add detergent and fabric conditioner, if required, to the dispenser drawer. Refer to the detergent manufacturer's dosage instructions.
- 3  Switch the machine on by pressing '**ON/OFF Pause**'. 'On' will illuminate in the display window.
- 4  Select the programme you require. You will hear a bleep and the programme temperature will illuminate in the display window followed by the spin speed. After 4 seconds the programme length, 'Time to End', will be displayed.
- 5  Select any optional wash feature(s) that you may require by pressing the appropriate button(s), indicator lights will show what you have chosen.
- 6  Press either the timed dry or sensor dry button until you see the setting you require in the display.
- 7  Press '**START/CANCEL**' to begin the programme. During the programme, status lights will glow to indicate at what stage in the cycle the programme has reached. The 'Time to End' displayed will count down the programme time to the end of the programme.
- 8 At the end of the programme 'End' will illuminate in the display window. Also a 'Keyhole' will glow indicating the door is locked. The machine will bleep and the light will go out when the door can be opened.
- 9  Switch the machine off by pressing the '**ON/OFF Pause**' button. We also recommend that you switch off the electricity and water supply.

The dispenser drawer

If you wish to use liquid detergent:

We recommend the use of a detergent ball as provided by your detergent manufacturer.

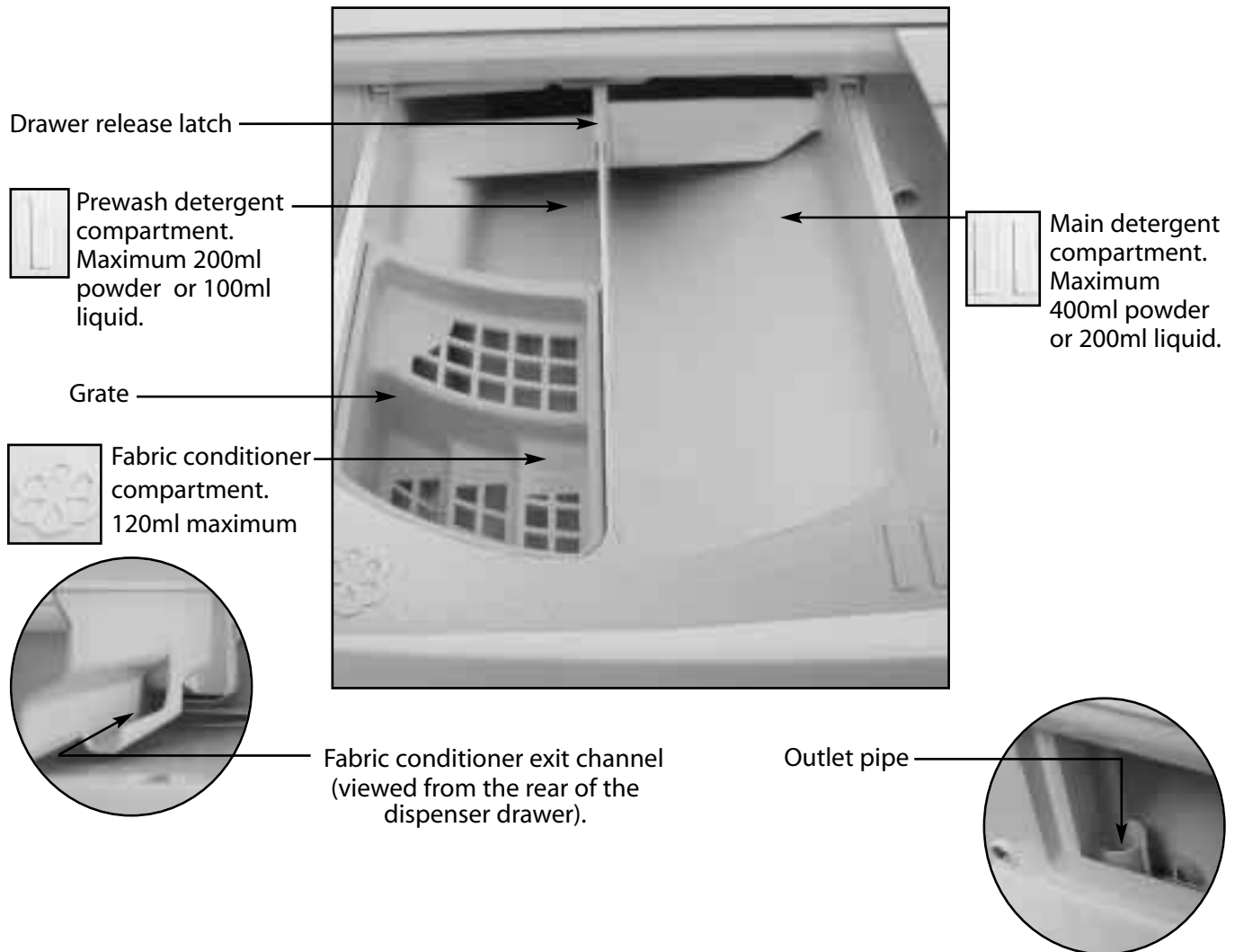

Choose a suitable detergent

- Follow the detergent manufacturer's recommendations to make sure you use the correct amount for your wash.
- To achieve the best wash results, the water hardness, degree of soiling and load size need to be considered and the recommended amount of detergent used.
- Choose 'lowsuds' automatic powder, liquid or tablets, designed specifically for automatic washing machines. Do not use handwash detergent, even on the handwash programme as excessive suds will occur.
- Do not use too much detergent or exceed the maximum level indicators.
- Do not use too little detergent, you will not achieve a clean wash. Follow the detergent manufacturer's recommendations.

WARNING:

- Do not put any item(s) into the drawer other than detergents that are designed to be released from the drawer as they may cause damage or blockage.

Dispensing powder detergent

To achieve the best wash results the manufacturer's recommended amount of detergent should be measured and added to the main detergent compartment (II symbol) (max. 400ml).



Dispensing liquid detergent

We recommend the use of a detergent dosing ball, as provided by your detergent manufacturer.

Dispensing tablets

Most tablets are dispensed via the machine drum using a net, or similar device, which is placed on top of the washload towards the back of the drum. However, some tablets are designed to be placed in the dispenser drawer. Check the pack for details.

Using in-drum dosing

Dosing devices - balls, nets etc can be used.

Place upright, on top of the wash load and towards the back of the machine.

DO NOT use with the pre-wash option.

DO NOT use if selecting a drying programme.

Pre-wash

When you are using the pre-wash option with your selected programme add detergent to the pre-wash compartment (I symbol). Add the detergent for the main wash to the main compartment (II symbol).

Adding fabric conditioner

Pour the recommended dosage of fabric conditioner into the compartment (flower symbol). Do not exceed the maximum fill line.



Wash programmes

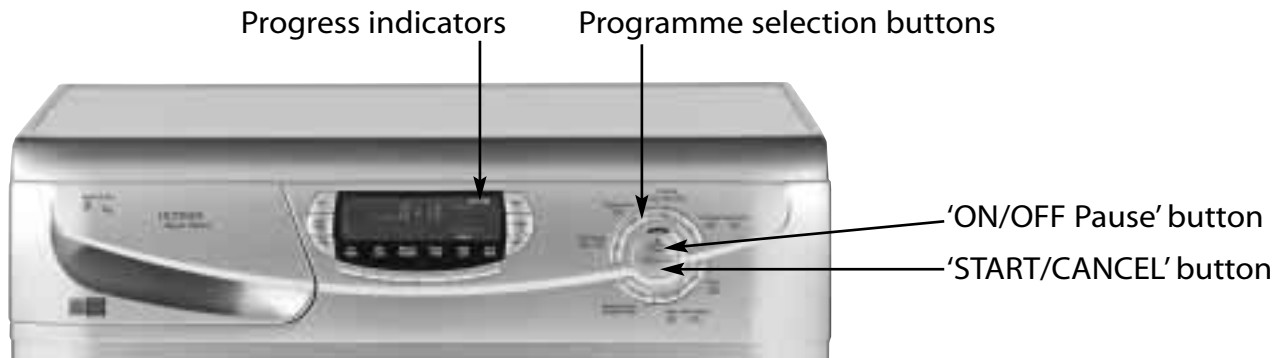

On-Off / Selecting a wash programme

Switch the machine 'On' by pressing the '**ON/OFF Pause**' button.

To begin the selected programme press '**START/CANCEL**'. In order to switch the machine off at the end of the wash programme press the '**ON/OFF Pause**' button.

To change a programme

Press the '**START/CANCEL**' button once. The machine will beep and enter a 2 minute pump out programme. '0:02' will be displayed in the window. Pressing the '**START/CANCEL**' button again will cancel the programme totally and 'On' will appear in the display window. A different programme can now be selected by pressing the required programme button. You might need to add detergent and fabric conditioner. Press the '**START/CANCEL**' button to begin the new programme.

The progress status lights

This set of lights indicate what stage in the wash cycle the selected programme has reached. Each light will appear in sequence as each stage of the programme is reached.

Door Locked Indicator... 'Keyhole' symbol

The '**Keyhole**' symbol will illuminate 2 seconds after you have pressed the '**START/CANCEL**' button and will remain lit throughout the wash programme.

The '**Keyhole**' symbol will be flashing at the end of the programme to indicate that the door is still locked. When the symbol goes off you will hear a bleep and the door can then be opened.

Door not closed

If a flashing 'Door' message appears in the display window, the door has not been closed properly and the programme will not start. Ensure that the door is closed properly by pushing it until you hear the catch click.

WARNINGS:

- Do not try to open the door during the wash programme.
- Do not allow children to play with the machine or tamper with the controls.
- If you cancel a programme part way through a wash or there is a power cut, take care when opening the door. The machine may contain hot water.
- This machine has a Child Lock feature, which when activated disables all controls (see 'Options').

Wash programmes

To select a programme to suit your individual requirements use the following series of tables, explaining the wash programme buttons and programme details. The programmes have been listed by Fabric Type.

The programme times 'Time to End'..

For each wash programme and option(s) selected the machine automatically calculates the estimated programme length '**Time to End**'. This is displayed in hours and minutes shortly after the wash programme temperature has been displayed. The '**Time to End**' will then remain lit throughout the wash programme and counts down to the end of the programme.

Note: These estimated programme times are dependant on the temperature and pressure of the incoming water supply, the option(s) selected and the load being washed. They may, therefore change during the fill stages of each programme to take into account the extra heating or filling time required.







To review the current wash programme during the wash cycle...

This feature allows you to check the running wash programme.





- To view the temperature of the selected programme - press the 'Variable Temperature' button once.
- To view the spin speed of the selected programme - press the 'Variable Spin Speed' button once.



After a few seconds the display window will return to the 'Time to End' showing the remaining programme length.





If you decide the selected programme does not suit your requirements you can change the programme, see previous page 'To change a programme'.

Fabric type - Cotton 						
Wash Label	Press Button	Display Window shows	Fabric	Wash Temp °C	Maximum dry weight load	Spin speed (rpm)
	Once		Non-Colourfast cotton, linen or viscose	40	6kg	1600
	Twice		Colourfast cotton linen or viscose without special finishes	60	6kg	1600
	Three times		White cotton and linen without special finishes	95	6kg	1600



Wash programmes

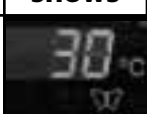



Fabric type - Acrylics and Synthetics 						
Wash Label	Press Button	Display Window shows	Fabric	Wash Temp °C	Maximum dry weight load	Spin speed (rpm)
	Once		Acrylics Acrylics and tri-acetate blends of these fabrics with wool, polyester and wool blends	40	3kg	800
	Twice		Synthetics Coloured nylon, polyester, acrylic and cotton mixtures, cotton or viscose with special finishes, coloured polyester and cotton mixtures.	50	3kg	800





Fabric type - Hand Wash Wool 						
Wash Label	Press Button	Display Window shows	Fabric	Wash Temp °C	Maximum dry weight load	Spin speed (rpm)
	Once		Shrink resistant hand washable wool, woollen blankets.	40	1.5kg	600
			Wool mixtures with cotton or rayon.	40	2.5kg	600

Fabric type - Silks and Hand Wash  						
Wash Label	Press Button	Display Window shows	Fabric	Wash Temp °C	Maximum dry weight load	Spin speed (rpm)
	Once		Silk Printed acetate	30	3kg	800
	Twice		Handwash A cool gentle action wash.	25	4kg	800

Wash programmes

Fabric type - Super Wash Cottons 						
Wash Label	Press Button	Display Window shows	Fabric	Wash Temp °C	Maximum dry weight load	Spin speed (rpm)
	Once		An intensive wash programme to get your whites even whiter.	60	6kg	1600

Fabric type - Cottons, Fast Wash 						
Wash Label	Press Button	Display Window shows	Fabric	Wash Temp °C	Maximum dry weight load	Spin speed (rpm)
	Once		For freshening up lightly soiled items. Warning: not for woollen, silk or delicate items.	60	5kg	1600
	Twice		For freshening up lightly soiled items. Warning: not for woollen, silk or delicate items.	30	3kg	800

Fabric type - Cottons and Delicates, Rinse and Spin programmes				
Press Button	Display Window shows	Fabric	Maximum dry weight load	Spin speed (rpm)
Once		Rinse and Spin Fast Cottons	6kg	1600
Twice		Rinse and Spin Slow Delicates	3kg	800
Three times		Fast Spin Cottons	6kg	1600
Four times		Slow Spin Delicates	3kg	800

Dry programmes

Drycare tips...

Items not suitable for tumble drying:

- Garments with the ITCL code  .
- Woollens.
- Large, bulky items eg. quilts, bedspreads, pillows etc... expand when dry, preventing air flow through the appliance.
- Items containing plastic film, foam rubber or rubber like materials eg. pillows, cushions, PVC rainwear or inflammable articles which contain inflammable substances eg. towels contaminated with hair lacquer.
- Fibreglass (eg. some types of curtains).
- Items which have been dry cleaned.

Important information:

- A 20 minute 'cool tumble' is included at the end of drying, allowing fabrics to cool down, minimising creasing.
- A spin cycle may be carried out during drying if you have set a cotton programme.
- Select HIGH heat (for Cottons) by pressing the Drying Heat button. If not selected the programme will automatically default to LOW heat (for Synthetics).
- This machine incorporates a sensor dry programme that can be used with either HIGH or LOW heat settings.
- Your washer dryer is fitted with a revolutionary self-clean filter, which will flush with water during drying.

Dry Weight Loads...

Two examples of maximum wash loads for different types of fabric.

COTTON

2 Bath Towels
6 Shirts
6 Blouses
2 sets of Pyjamas
4 items of Underwear
2 Pillow cases

= 5kg

SYNTHETIC

3 Children's Dresses
5 Shirts
6 Blouses
2 sets of Pyjamas
4 items of Underwear

= 3kg

Dry programmes

Independent drying programme...

1 Remove the wet laundry and dosing ball (if used) until the correct 'Drying Weight Load' is left in the drum. Close the door until it clicks shut.

2  Press the '**ON/OFF Pause**' button. 'On' will illuminate in the display window.

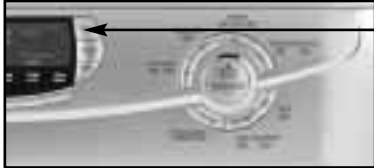
3  Press the Drying Heat button to select high heat (if required) for Cotton. The indicator light will show selection.



4  Set the required drying time or Sensor dry option.

5  When all the selections have been made press the '**START/CANCEL**' button. The door will lock, the 'Keyhole' will glow in the display.

6 A short time after the programme has finished the 'Keyhole' will go out and you can open the door.

Drying Heat			
Press Button	Display Window shows	Fabric	Maximum dry weight load
Once	High Heat	Cotton	5kg
Twice	Low Heat	Synthetics	3kg

Timed Dry			
Press Button	Display Window shows	Fabric	Maximum dry weight load
Once	180	Cotton or Synthetic dependent upon Drying Heat selection	1kg - 5kg
Twice	150		
Three times	120		
Four times	90		
Five times	60		
Six times	45		
Seven times	30		
Eight times	OFF		

Sensor Dry			
Press Button	Display Window shows	Fabric	Maximum dry weight load
Once		Cupboard Dry	1kg - 5kg
Twice		Hanger Dry	
Three times		Iron Dry	

WARNINGS:

- If your machine is not permanently plumbed in, turn on the cold water supply to the appliance and hook the drain hose over the sink to enable the condensing action to work.
- The dryer is intended for use only where water is used for the cleaning process.
- Be careful not to touch the drum at the top as this area gets hot during drying.
- On no account should liquid fabric conditioner be added during the drying process.
- Misuse of the dryer may create a fire hazard.

Options

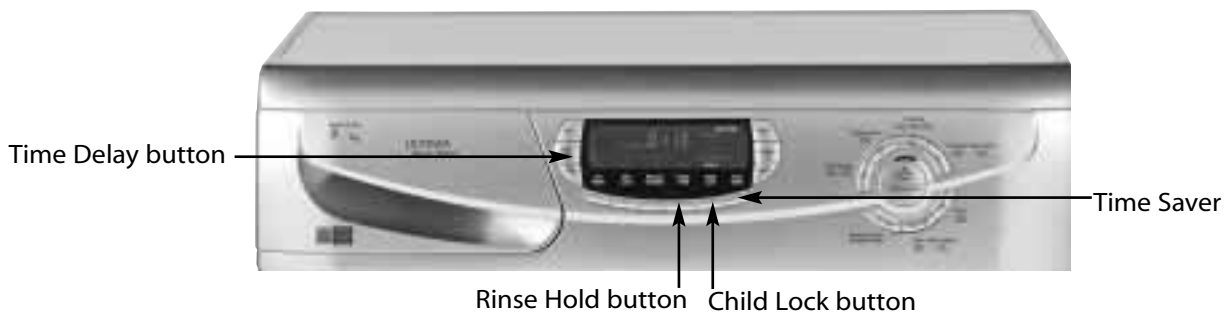

Choosing an option button

The features listed below are all available with any wash programme selected.

Child Lock

- **When activated all the buttons will be disabled and a child will not be able to alter any wash programme or option settings. Once selected this feature remains activated, even when the machine is 'off'.** To use this feature press the 'Child Lock' button. The child lock icon will light and the feature is activated. If any of the control buttons are pressed, the child lock icon will flash and the machine will bleep 3 times: no alterations to the control settings will be allowed. If power is interrupted, at any time, pressing any button will reactivate the child lock feature.

To deactivate this feature hold the 'Child Lock' button down for 2 seconds. You will then hear a bleep and the child lock icon will go out.

Time Delay

- **This feature allows you to delay the start of any wash programme selected. The programme start can be delayed for a maximum of 24 hours.**

To use this feature select the wash programme and any options you require and then press the 'Time Delay' button once. The display window will indicate '1hr'. Repeated pressing of the 'Time Delay' button will increase the delayed start time in 1 hour increments up to 24 hours maximum and will scroll back to 'Off'. Once you have selected the appropriate time delay press the 'START/CANCEL' button. The display window will show the set time delay. The words 'Time Delay' will continually flash in the display window and the time will count down in hours until the end of the Time Delay. Then the 'Time to End' will be displayed and the programme will start.

Rinse Hold

- **This option holds clothes in the final rinse water, keeping them fresh until you are ready to complete the programme**

To use this option press the 'Rinse Hold' button once, illuminates in the display window above the 'Rinse Hold' option button. Complete the final spin by pressing the 'Rinse Hold' button again when the symbol is flashing. **This option is not available with Wool, 30° Fast Wash and the Spin only programmes.**

Time Saver

- **This option can be used to reduce the time of a wash programme.** To use this option press the 'Time Saver' option button once before the wash programme is started, the chevron progress lights will illuminate. **This option is not available with Wool, Silk, Hand Wash, Super Wash, Fast Wash and Rinse and Spin programmes.**

Options



Pre Wash Mini Load Reduce Creases

Pre Wash

- **This option provides a short wash cycle, at 30°, before the selected wash programme starts. It is used to loosen the heavy soil deposits on clothes. It is recommended that detergent is also used in the Prewash compartment.** To use this option press the 'Pre-Wash' option button once and illuminates in the display window above the 'Pre-Wash' option button. Press again to cancel the option.
This option is not available with the Super Wash, Wool, Handwash, Fast Wash and the Rinse and Spin programmes.

Mini Load

- **Select this option for washing a smaller load. In addition to reducing actual washing time, this option will reduce the water and energy consumption by up to 50%.** To use this option, press the 'Mini Load' option button once and illuminates in the display window above the 'Mini Load' option button. Press again to cancel the option.
Note: You can reduce the amount of detergent you use with this wash.
This option is not available with Super Wash, Wool, Silk or Handwash programmes.

Reduce Creases

- **This option reduces the wash action and spin speed for delicate clothes.** To use this option press the 'Reduce Creases' option button once and illuminates in the display window above the 'Reduce Creases' option button. Press again to cancel the option.
This option is not available with Super Wash, 95° Cotton, 30° Fast Wash, Wool, Silk, Handwash and Spin Only programmes.

Automatic Features

Auto half load

Auto half load saves you time and money when washing smaller loads. Water levels are automatically adjusted to cater for the different loads.

Unbalanced load warning

Your machine has an inbuilt feature to prevent it spinning with an unbalanced load. This will minimise excessive vibration and prolong the life of the machine.

Before each spin the machine 'senses' the load within the drum and if the machine considers the load to be unbalanced, it will not automatically spin. Instead the machine will try to redistribute the load to achieve balance by tumbling backwards and forwards. If it is unable to balance the load after the sixth attempt the machine will abort the spin process.

If this safety feature is encountered you can spin the load, after first opening the door, redistributing the load and reselecting a fast or slow spin programme. In the case of small loads or single items you may try adding some extra items of a comparable size to help balance the load.

Options

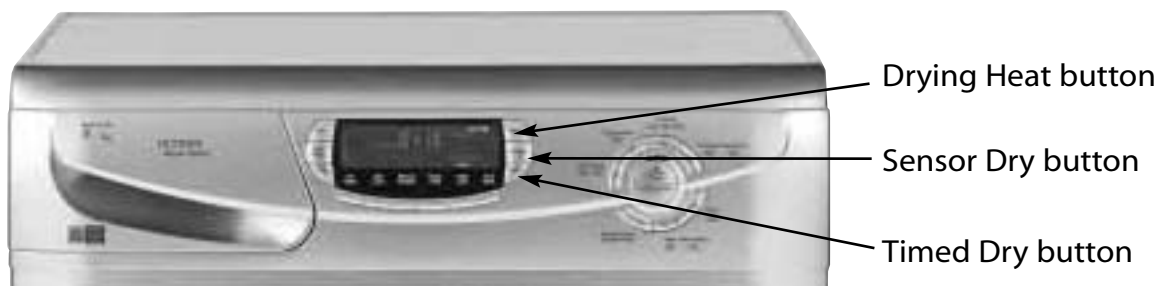

Drying Heat

- **This control option can be used to select high heat for drying.** High heat (for drying cottons) can be selected by pressing the '**Drying Heat**' button. The display window will show High Heat or Low Heat. If high heat is not selected the programme will default to a low heat setting.

Timed Drying

- **This control option can be used to select a time for drying.** The time for drying will be illuminated in the display window when you press the '**Timed Drying**' button. This is based on time from 0 minutes to 180 minutes. By pressing the '**Timed Drying**' button again you will hear a beep and the time will have been reduced from 180 minutes to 150 minutes. Keep pressing the button and you will see the time reduce in steps, down to OFF.

Sensor Drying

- **This control option can be used to select one of three levels of sensor drying.** The sensor level for drying will be illuminated in the display window when you press the '**Sensor Drying**' button. Level one is 'Cupboard Dry' and should be used if you want laundry to be very dry. This is recommended for items such as towels and bathrobes. Level two is 'Hanger Dry' and should be used if you want to dry items ready to put away. Level three is 'Iron Dry' and should be used if you want to dry items to be slightly damp for ease of ironing.

NOTE

To select a Wash and Dry programme:
Select a wash programme, then a drying programme by following the above steps.

Wash & Dry is not available with the 25°C Handwash, Wool, 30°C Silks and Drain programmes.

Cleaning and maintenance

WARNINGS:

- Do not clean any part of your machine with abrasive cleaners, scouring agents, acids, chlorine based bleach or metal polish as they may cause damage.
- Do not try to clean any part of the dispenser drawer while the machine is working.

Removing and cleaning the dispenser drawer and compartments

Note: You should clean the dispenser drawer regularly.

- 1 Pull the dispenser drawer out until it reaches its stop.
- 2 Press the drawer release latch down to remove the dispenser drawer.



- 3 Clean and dry the dispenser drawer, syphons, grate and fabric conditioner exit channel. Regularly clean the outlet pipe area.

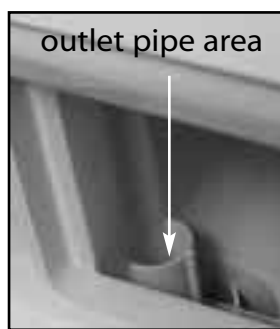
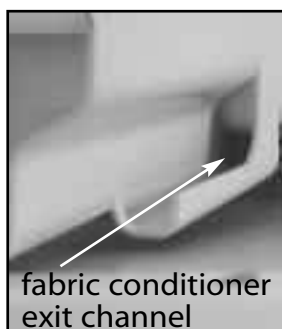

- 4 Replace the dispenser drawer in position and push it firmly back into place.

Cleaning the outside

Use a damp cloth to clean the outside surfaces of the machine.

Cleaning the door bowl

Clean the inside surface of the door bowl regularly with a soft cloth.



Harsh abrasive cleaners should not be used as they can scratch the surface. A build-up of soiling and water hardness residue may result in water leaking from the door.

Maintenance wash

Using too little detergent can cause a build up of grease, dirt and hard water salts, which, over time may damage your machine, your clothes and could cause the machine to smell.

We recommend you carry out a maintenance wash 2 or 3 times a year avoid a build up of greasy deposits and water hardness residue. Simply run a 95° White Cotton programme without laundry and without detergent.

NOTE: This will take approximately 2 hours 30 minutes to complete.

- Where the drying only option is regularly used, do this on a monthly basis.

Troubleshooting...

In the unlikely event that you have problems with your machine, the following guide may help you to get your machine working correctly straight away...

The machine will not start...

- Close the door. Check that the machine has power. Choose a programme and press the **'START/CANCEL'** button. Check to see if a 'Keyhole' symbol is flashing in the display window, if so, see below.
If it is not, check to see:
 - i) If **'Time Delay'** has been selected.
 - ii) The machine is plugged in and is switched 'On'.
 - iii) If the socket is OK. Try another appliance in the socket to check.
 - iv) If the fuse in the machine plug is OK. If not, replace it, see 'Connect your machine to the electrical supply' (see section: INSTALLING YOUR MACHINE).
 - v) If **'Child Lock'** is activated (see below).

'Door' is flashing in the display window...

- Shut the door firmly, until it clicks. The symbol should now go out.

A 'Tap' symbol is flashing...

- This means that the machine cannot fill. Check that the water supply is turned on and that the inlet hoses are not kinked.

The machine beeps 3 times upon pressing a button...

- Check:
 - i) If the **'Child Lock'** is activated (see below).
 - ii) Is a programme currently running and the programme can not be changed?
 - iii) The option is not available with the selected wash programme.

A 'Child Lock' symbol is lit...

- This means that the machine has been child locked. Deactivate this feature by pressing and holding in the **'Child Lock'** button for 2 seconds. You will hear a beep and the 'Child lock' symbol will go out, allowing you to use the machine normally.

The door will not open...

- Has the programme finished? Is **'End'** lit in the display window and the **'Keyhole'** symbol deactivated?
The door will not open until the **'Keyhole'** symbol goes out shortly after the programme has finished.
- There is still water in the machine. Go through all the points in the next section, 'The machine will not pump out water...'

The machine will not pump out the water...

- Make sure that there is no blockage in the drain hose and that it is not kinked.
- Is the drain hose installed correctly?
- If you have connected your machine to a sink waste system, make sure that you have cut out the membrane from the under sink drainage system. (see section: INSTALLING YOUR MACHINE).
- Ensure that the drainage system, standpipe or under sink connection is free from any blockage.
- If any of the above are found to be the cause of your problem you will need to run the machine through a spin only programme.
- If you have chosen **'Rinse Hold'**, the light will flash until you press the **'Rinse Hold'** button to continue the programme.

The machine is leaking...

- Check the fill hoses have been tightened at both ends? If not, tighten them.
- Are the fill hoses tightly fitted yet still leaking? If so, replace the rubber washers.
- Is the standpipe or household drain blocked? You will need to call a plumber if you cannot clear the blockage.

The clothes are hot at the end of the wash programme...

- Check that the grey fill hoses are fitted correctly:
RED connector to HOT
BLUE connector to COLD
Note: clothes will be quite warm if a drying programme has been selected.

continued...

Troubleshooting...

I cannot read the information in the display window...

- If the display window is not showing the correct information, switch the machine Off at the electric socket, wait 5 seconds and switch back on.

The 'Time to End' display jumps...

- The estimated programme times are dependant on the temperature and pressure of the incoming water supply, the option(s) selected and the load being washed. They may, therefore change during the fill stages of each programme to take into account the extra heating or fill time required.

The programme takes a long time...

- Some programmes do take a long time. Things which can lengthen the programme time include low temperature and low pressure of the incoming hot water supply, or low cold water pressure.

The machine makes a noise or vibrates during a spin programme...

If the noise is very loud you should check whether:

- You have removed the transit bolts.
- You have removed the polystyrene base.
- You have correctly adjusted the front feet to stabilize the machine.
- You have removed loose items such as coins from pockets, as these can rattle about inside the machine drum and cause damage.

The laundry has not spun dry...

- Did you use a short spin programme? If so, try again using a faster spin programme.
- Did you reduce the spin speed of the selected programme using the 'Spin' option control button? If so, select a faster spin programme.

The dispenser drawer will not close properly...

- Please check that the drawer is properly aligned.
- Is the drawer clogged with detergent? (see: CLEANING & MAINTENANCE).

Steam is coming from the dispenser drawer...

- We have designed the machine to release steam from the dispenser drawer during hot washes, so don't worry. It may also vent during drying.

Suds are coming from the dispenser drawer...

- Have you used the correct low suds automatic detergent? See 'The Dispenser' - Choose a suitable detergent.
- If you have used the wrong type of detergent, flush out your machine by choosing a rinse programme.

Not all of the detergent has been flushed away...

- Check that your water supply taps are turned on fully.
- Check the inlet hoses are not kinked.
- Is your hot water pressure low? If so you may need a cold fill adaptor to run your machine as cold fill only.

The laundry is not dry after using the dry programme...

- Is the cold water turned on at the tap?
- Did you select the correct heat/time setting?
- Was the laundry spun dry at the end of a wash programme, if not select the spin and dry option to suit the fabric type.
- Is your water pressure within limits?

Remember, you will be charged for a service call for problems caused by incorrect installation, non-removal of transit bolts or packaging, leaks from household pipework, loose or blocked fill and drain hoses.

Washing items which do not have a wash label or washing items that are not intended as machine washable and not emptying contents from pockets may cause pump or drain blockages or may damage components of the machine.

If the machine is still not working contact Hotpoint Service, see the back page.



Hotpoint guarantee

“Satisfaction guaranteed or your money back”

We give you a unique ‘satisfaction guaranteed’ promise - **valid for 90 days** - after you have purchased your Hotpoint product. If there is a technical problem simply call Hotpoint Repair service or visit our web-site at www.theservicecentre.co.uk and where necessary, we will arrange for an engineer to call. If the technical problem is not resolved under this guarantee, **we will replace your machine or, if you prefer, give you your money back.**

All Hotpoint appliances carry a fully inclusive 12 month parts and labour guarantee as well as free replacement parts for the first 5 years (except microwaves, selected integrated appliances and cooker hoods, which have a one year guarantee) provided that they are fitted by a Hotpoint engineer.

Guarantee terms and conditions

Your guarantee is only applicable in the United Kingdom or Republic of Ireland and is subject to the following provisions that your appliance:

- Has been installed and used correctly in accordance with this instruction booklet.
- Has been used solely for domestic purposes and is located on domestic premises (ie. not for commercial or trade use).
- Has been properly connected to a suitable electrical supply voltage as stated on the appliance rating plate.
- Has not been subject to misuse, accident, modified or repaired by anyone other than one of our own service engineers.



For pre purchase information on any other Hotpoint product call: 08701 50 60 70
or visit: www.hotpoint.co.uk



Recycling & Disposal Information

As part of Hotpoint’s continued commitment to helping the environment, Hotpoint reserves the right to use quality recycled components to keep down customer costs and minimise material wastage.

Please dispose of packaging and old appliances carefully. To minimise risk of injury to children, remove the door, plug and cut mains cable off flush with the appliance. Dispose of these parts separately to ensure that the appliance can no longer be plugged into a mains socket.



After sales service

“No company is better positioned to offer an after sales service on a Hotpoint appliance than us - the manufacturer”

As part of our commitment to you, all Hotpoint appliances have the added benefit of a fully inclusive parts and labour guarantee for the first 12 months. In addition to this you also have the advantage of **free replacement parts for the first 5 years** when fitted by a Hotpoint engineer. When the 12 months parts and labour guarantee expires we offer the following after sales service options:

Repair Service and Information Help Desk

UK: 08709 066066

www.theservicecentre.co.uk

Republic of Ireland: 1850 302 200

Note: Our operators will require the Model number and the Serial number of your machine, see page 2 for the location of these numbers.

Available 364 days a year with a fast, effective and value for money service.

We have the largest white goods repair service in the UK with over 1200 of our own fully trained engineers. All repairs include a parts and labour guarantee for 12 months from the date of the repair.

If you require any information or have any questions about your appliance, our operators are on hand with help and advice.

All this ensures that you will receive the best available after sales service possible.

Extended Warranties

UK: 08709 088 088

www.theservicecentre.co.uk

Republic of Ireland: 1850 502 200

Whether you have just one or a number of Hotpoint appliances in your kitchen, we offer two service cover plans to give you total peace of mind.

- Repair Protection Plan - FREE service repairs for a single Hotpoint appliance during the period of cover.
- Kitchen Cover - FREE service repairs for all your Hotpoint appliances less than 8 years old.

Genuine Parts and Accessories

UK: 08709 077 077

www.theservicecentre.co.uk

Republic of Ireland: (01) 842 6836

A wide range of genuine parts and accessories are available from our hotline or through our web site.

Genuine parts and accessories, extended warranties and service repairs are all available on our web-site at:



www.theservicecentre.co.uk

Notes...

Notes...



Key contacts After Sales Service

Over 1200 trained specialists, directly employed by us, ensure that you can have complete confidence in both the appliances and services we offer.



Repair Service and Information Help Desk

UK: 08709 066 066

(Open 8 to 8 Mon - Fri, 8 to 6 Sat, 10 to 4 Sun & Bank Holidays)

www.theservicecentre.co.uk

Republic of Ireland: 1850 302 200

Note: Our operators will require the following information:

Model number

Serial number

Extended Warranties

UK: 08709 088 088

(Open 8 to 8 Mon - Sun)

www.theservicecentre.co.uk

Republic of Ireland: 1850 502 200

Genuine Parts and Accessories

UK: 08709 077 077

(Open 8-30 to 5-30 Mon - Fri & 9 to 12 Sat)

www.theservicecentre.co.uk

Republic of Ireland: (01) 842 6836

Merloni Elettrodomestici UK Ltd, Morley Way, Peterborough, PE2 9JB.