

ZANUSSI

**Instructions
for the use and care of
ZE 2002 IS electronic
washing machine**

Important

The use of this new appliance is quite simple. However, to obtain the best results it is important that you carefully read this handbook and that you strictly follow all relevant instructions prior to starting the machine for the first time.

This handbook contains all required directions for a correct installation, use and maintenance of this appliance, in addition to giving a number of useful hints.

Contents

Installation

Unpacking	Page 5
Positioning & Levelling	Page 5
Water connection	Page 6
Electrical connection	Page 8

Operation

Controls description	Page 10
Loading the clothes	Page 12
Making the machine operational	Page 12
Wash cycle selection	Page 13
Filling the wash powder & additives	Page 14
Starting the wash cycle	Page 14
Interrupting a cycle in progress	Page 15
End of cycle	Page 15
Helpful tips	Page 15
Some basic cycles	Page 16
Special cycles	Page 17

Care & Cleaning

Cleaning the machine	Page 18
Cleaning the drain filter	Page 18

Instructions for matching to kitchen environment

Instructions for doors reversal	Page 19
Instructions for application of decorative paneling on door and on bottom panel	Page 20
Building-in directions	Page 21

Something not working	Page 22
--	----------------

Servicing & Spare Parts	Page 22
--	----------------

Technical data

Width	23.6 ins (600 mm)
Overall depth (excluding hose)	23.6 ins (600 mm)
Height	33.5 ins (850 mm)
Weight	178.5 lbs (80 kg)
Dry clothes capacity (excluding synthetic fabrics and wool).	10 lbs (4.5 kg)
Revolutions during spinning	500/1000 r.p.m.
Total powder absorbed	2500 W
Heater rating	2300 W
Motor rating during washing	250 W
Motor rating during spinning	350/700 W
Water load: normal level	2.9 gals (13 l)
Water load: high level	4.4 gals (20 l)
Maximum water pressure	110 p.s.i. - 759 kN/m ²
Minimum water pressure (cold)	7 p.s.i. - 48 kN/m ²
Minimum water pressure (hot)	4 p.s.i. - 27 kN/m ²
Supply voltage	220 V - 240 V
Supply frequency	50 Hz

Installation

Unpacking

After removing outer carton, reinforcing angles and polythene wrapping, proceed as follows:

Using the special spanner that comes with the machine, unscrew and remove the three bolts from the back of the appliance (Fig. 1). The spanner supplied with the machine is provided with an hexagonal insert and should be used for this purpose.

Insert a screwdriver into the free holes left after removing the bolts, and tilt it as required to cause the three plastic spacers inside the machine to fall down.

Rest the washing machine on its back and remove the two inner angle packings by pulling the left plastic bag A first and then the right plastic bag B (Fig. 2). This operation should be carried out very carefully to prevent the angle packings from damaging the internal components of the machine.

Remove the polystyrene base packing and the three plastic spacers that fell down during the preceding operations.

Note:

It is advisable to keep all parts of the inner packing including the three bolts removed from the back of the appliance, for re-use in case the machine has to be transported again.

Positioning & Levelling

Set up the washing machine in its permanent operating position and then carefully level it by adjusting the levelling feet (Fig. 3) with the spanner that comes with the machine.

It is recommended to carry out this adjustment very accurately to avoid any vibration, noise or shifting of the appliance during operation.

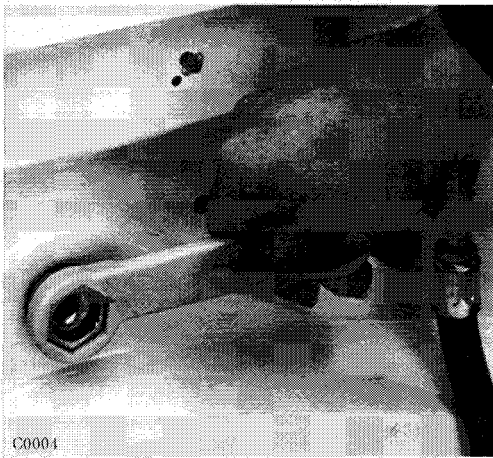

C0004

Fig. 1

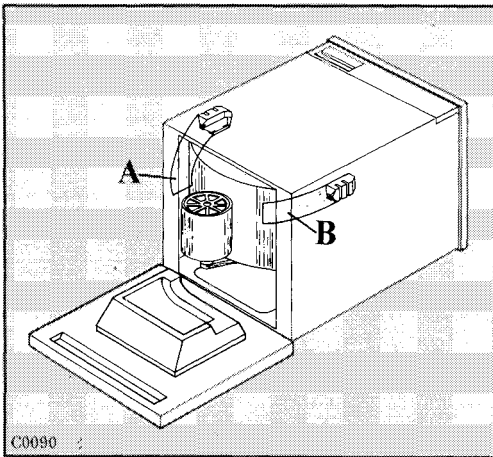

C0090

Fig. 2

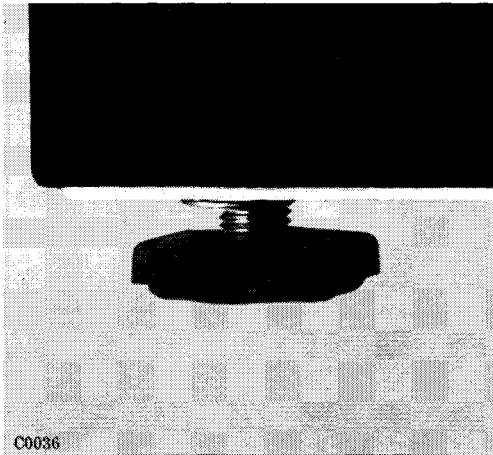

C0036

Fig. 3

Water connection

The machine may either be plumbed in or connected to existing taps. Details are given below.

Water supply

Separate supplies of hot and cold water are necessary. Single outlet gas or electric heaters are not suitable. If only cold water supply is available, connect the two hoses to a cold water tap.

Water outlet connection

The drain pipe from this machine must connect into the main drain from the premises but not into the rainwater drain. Information as to the type of drain servicing your premises can be obtained from a builder or the Local Authority. The curved end of the outlet hose should be firmly hooked over the edge of a sink or connected to a suitable drain pipe in the wall or under the sink; however, such a drain pipe should have a built-in air break in order to avoid water syphoning from the machine during draining.

The top of the drain hose (curved end) should not be lower than 50 cms (20 ins) or higher than 85 cms (34 ins) from floor level (Fig. 4).

The water should be able to drain freely and the end of the outlet hose must not be under water. It is, therefore, advisable that the drain pipe, if fused, has an internal diameter of at least 4 cms (1.5 ins). Also, ensure that the drain hose is not blocked or placed in such a way as to obstruct the normal water flow. If the drain hose is to be hooked over the sink, ensure that the sink is empty and that the sink plug is not blocking the plug hole. If an extension hose is required, it should not exceed a length of 180 cms, its diameter should not be smaller than of the original drain hose and the extension hose should not be choked (kinked) in any way.

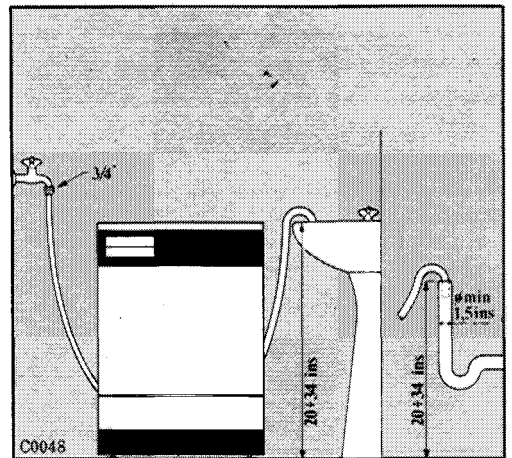

Fig. 4

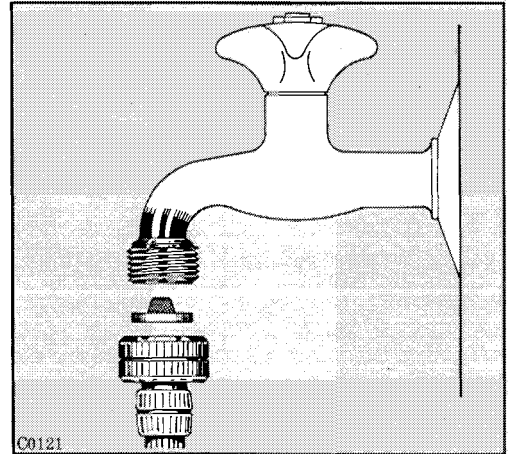

Fig. 5

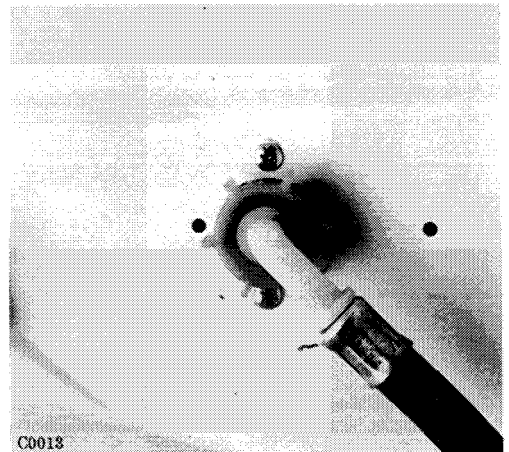

Fig. 6

The hose is to be positioned at floor level and only the terminal part should be placed at the requisite drain level previously indicated.

A failure to comply with these requirements may result in a malfunction of the drain pump.

To correctly carry out the extension of the drain hose, it is advisable to use the special connector with hose clamps which can be supplied as an optional attachment.

Plumbed installation

It is important that work is carried out by a qualified plumber.

Use from existing taps

1. Mixer taps are unsuitable and must not be used.
2. Connect the red pipe connection to the hot and the other to the cold tap (see note below).

Important

If the rate of flow on the cold water valve is too slow, remove the flow control device of the valve;

If the pressure on the hot tap exceeds approximately 10 lb. per square inch, it will be necessary to fit the flow control device, into the hot water valve.

Tap connections

For taps with a 3/4 inch gas thread, fit the washers to the inlet hoses and connect as shown (fig. 5).

The other end of the water inlet hoses, which are connected to the appliance, can be turned in any required direction by loosening their ring nuts.

After setting the inlet hoses as desired, be sure to tighten their ring nuts again to prevent leakages (fig. 6).

If the water supply is from new pipes or from pipes which have not been used for a long time, it is advisable to run off a certain amount of water before connecting the machine. This will avoid foreign matter blocking the filters.

Additional hints for connection of water inlet hose

If the water supply in your area is hard it is possible that the filters situated in the fill valves can become blocked with sand or limestone deposits and in extreme cases this can cause a breakdown of the fill valves, i.e.: no water fill or continuous filling.

We would suggest that you install supplementary strainers which should be fitted on the fill hoses of your machine. For information about the availability of these supplementary strainers you should contact your local plumber.

Electrical connection

WARNING: THIS APPLIANCE MUST BE EARTHED. The manufacturer declines any liability should this safety measure not be observed.

If the plug that is fitted to your appliance is not suitable for your socket outlet, it must be cut off and the appropriate plug fitted.

The cut off plug should be disposed of to prevent the hazard of electric shocks in case it should be plugged into a 13 Amp socket in another part of your home.

Important

The wires in this mains lead are coloured in accordance with the following code:

GREEN AND YELLOW - EARTH

BLUE - NEUTRAL

BROWN - LIVE

If you fit your own plug, the colours of the wires in the mains lead of your appliance may not correspond with the markings identifying the terminals in your plug, this is what you have to do:

Connect the green and yellow (earth) wire to the terminal, in the plug which is marked with the letter "E" or the earth symbol \perp , or coloured green, or green and yellow.

Connect the brown (live) wire to the terminal in the plug which is marked with the letter "N" or coloured black.

Connect the brown (live) wire to the terminal which is marked with the letter "L" or coloured red.

The plug moulded on to the cord incorporates a fuse. For replacement use a 13 Amp BS 1362 fuse. Only ASTA approved fuses should be used.

The fuse cover/carrier must be replaced in the event of changing fuse.

The right fuse cover/carrier colour is the one shown by the coloured insert at the base of the plug.

The plug must not be used if the fuse cover/carrier is lost.

A replacement cover/carrier must be obtained from Zanussi Service Agents whose addresses are listed on the attached "Zanussi Service and Spares Nationwide".

This appliance complies with E.E.C. directive No. 76/889 of 4.11.76 relative to radio interference suppression.

Operation

Operation of this washing machine is co-ordinated and controlled by an electronic micro-processor which, on the basis of the data supplied by the operator (owner), optimizes the characteristics of each single wash cycle (i.e.: water load, drum rotation rate, washing water temperature, spinning speed, etc.) to ensure the best washing results with the least water and electricity consumption.

The operator can easily intervene on the basic programmes processed by the machine, to adapt the characteristics of the programme to his own requirements.

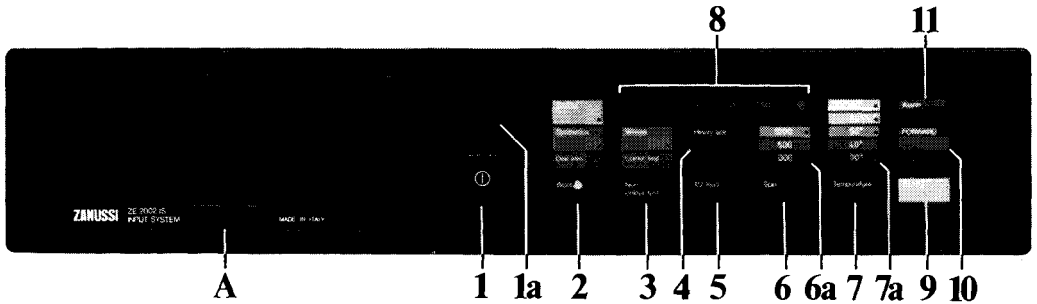

- A) Powder dispenser opening push button.
- 1) ON/OFF push button ①
- 1a) Pilot lamp Ⓜ
- 2) Fabric selectors: Cotton; Synthetics; Delicates; Wool 🌀
- 3) Colour fastness selectors: Whites; Colour fast; Non colour fast.
- 4) Heavy soil button.
- 5) 1/2 load button.
- 6) Spin button.
- 6a) Spin speed indicators 1000; 500; 000.
- 7) Temperature button.
- 7a) Temperature indicators 90; 60; 50; 40; 30.
- 8) Phase displays U ; U ; U ; U ; U .
- 9) START button.
- 10) FORWARD button.
- 11) Alarm light.

Controls description

1) "ON/OFF" push button

By depressing this button, the machine becomes operational (pilot lamp  lights up).

When depressed again, it will interrupt operation (pilot lamp  goes out).

2) Fabric selectors

To operate these selectors, slightly depress the front panel on the corresponding symbol and a brief sound signal will follow.

Depending on the type of laundry to be washed, depress one of these 4 selectors according to the following directions:

Depress selector "Cotton" to wash cotton, linen & hemp fabrics.

Depress selector "Synthetics" to wash strong synthetics and mixed (blended) fabrics.

Depress selector "Delicates" to wash delicate synthetics.

Depress selector "Wool  " to wash wool garments bearing the Woolmark label "Pure New Wool - washing shrink resistant".

Then the pilot lamp of the depressed selector lights up, it indicates that the microprocessor has accepted the information.

3) Color fastness selectors

Depending on the colour fastness of the garments to be washed, depress one of these 3 selectors according to the following directions:

Depress selector "Whites" to wash white fabrics.

Depress selector "Colour fast" to wash fabrics with fast colours.

Depress selector "Non colour fast" to wash fabrics with delicate colours.

When the pilot lamp of the depressed selector lights up, it indicates that the microprocessor has accepted the information.

4) Heavy soil button

This button should be depressed to wash heavily soiled clothes.

In this case, the main wash (with the exception of the "wool  " cycle) will be preceded by a prewash with water heated up to 40 °C. In the case of the wash cycles with water temperature below 40 °C, the prewash water will automatically be heated to the same temperature as the main wash water.

When the pilot lamp of the depressed button lights up it indicates that the microprocessor has accepted the information.

5) "1/2 load" button

When this button is depressed because you only have a reduced washload (i.e.: a max. dry weight of 2.25 kg. of cotton, linen, hemp; a max. dry weight of 1.5 kg. of absorbent cloth, e.g. towelling, a max. dry weight of 1 kg. of synthetic and mixed fabrics), it will make it possible to obtain a substantial saving in water and electricly consumption.

This button will not affect the "wool  " cycle.

When the pilot lamp of the depressed button lights up, it indicates that the microprocessor has accepted the information.

6) "Spin" button

When a wash cycle is entered in the system, the microprocessor automatically selects the optimal spinning speed and duration. The spinning speed is shown by the relevant indicators (6a).

It is possible to reduce the spinning speed, depending on your requirements, from 1000 to 500 r.p.m. by depressing the "Spin button" or you can completely cut off all programmed spinning phases displays and also turn off the cycles phases display.

When the spinning speed is reduced from 1000 to 500 r.p.m.:

In the wash cycle for cotton, the intermediate spinning phases are cut out and the final spinning time is reduced to 2 minutes only;

In the wash cycle for synthetics, the final spinning time is reduced to 30 seconds only.

7) "Temperature" button

The optimal washing temperature is automatically selected by the microprocessor whenever a wash cycle is entered in the system.

The washing water temperature is shown as follows by the relevant indicators (7a):

When the light is on **90°**:
main wash with water at 90 °C.

When the light is on **60°**:
main wash with water at 60 °C.

When the light is on **50°**:
main wash with water at 50 °C.

When the light is on **40°**:
main wash with water at 40 °C.





When the light is on **30°**:
main wash with water at 40 °C.

By depressing the "Temperature" button you can reduce the washing temperature, depending on your requirements, or cut out water heating completely (cold wash): in this case no pilot lamp will light up.

To safeguard the fabrics against human error, the washing temperature selected by the microprocessor cannot be increased.

8) Cycle phase display

When a wash cycle is entered in the system, these displays light up showing the various phases that make up a wash cycle.

-  : prewash
-  : main wash
-  : rinses
-  : drain
-  : spin

Once the wash cycle is started, only the display corresponding to the cycle phase being carried out remains lit.

The prewash  display will only light up if the "Heavy soil" washload button is also depressed.

Note:

at the end of the wash cycles for synthetic fabrics, the drain  display flashes to remind you that - when the wash cycle is completed - the water has to be drained.

9) "START" button

By depressing this button, after completely entering the wash cycle in the system, the machine starts working. All displays go out with the exception of the one that indicates the cycle phase being carried out.

When depressed during operation, it will reinstate the displays relevant to the wash cycle being carried out.

If depressed at the end of the wash cycles for synthetic fabrics, when the drain  display flashes, it permits draining of the water.

10) "FORWARD" button

By keeping this button depressed for a few seconds, the cycle phase being carried out will be skipped (cancelled), the relevant display will go out and the cycle will move on to the next phase.

You can therefore carry out single, separate rinse and/or spin phases.

11) "Alarm" light

A brief flash from this warning light when the machine is switched on indicates that everything is in order and that you may therefore enter a wash cycle in the system.

A continuous flashing indicates a malfunction; in this case see chapter "something not working".

Loading the clothes

To open the front door, push it on the right side.

Open the loading door by pulling the small double action catch (Fig. 7) to the left first and then outwards.

Load the clothes opening them out and then close the door again.

It is always advisable to sort your laundry according to fabric type, and colour to obtain the best wash.

Ensuring the machine is operational

After loading the clothes, make sure that:

The plug is in the wall socket.

The water tap is turned on (fully open).

The drain hose is correctly placed.

The loading door is correctly closed.

Then depress the "ON/OFF" pushbutton, (pilot lamp  lights up).

A single brief flash from the "Alarm" light indicates that you may proceed to enter a wash cycle in the system.

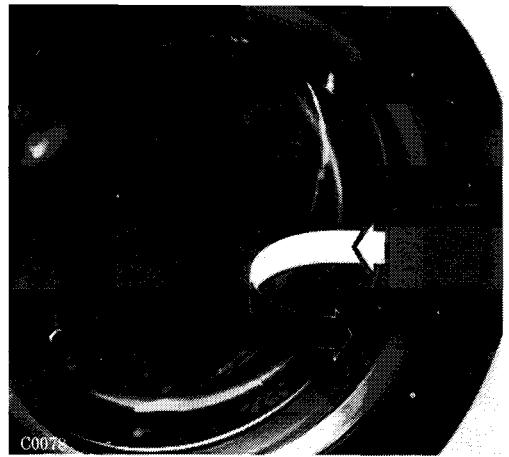

Fig. 7

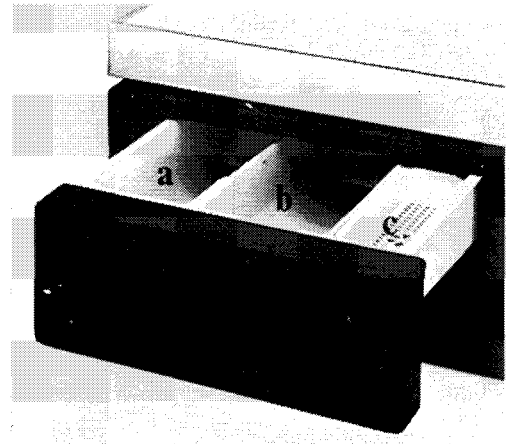

Fig. 8

Wash cycle selection

Cycle selection is to be carried out according to fabric type and colour fastness of the clothes to be washed by depressing the “fabric selectors” and “colour fastness selectors”.

At this point, the relevant wash temperature and spin speed indicators - as selected automatically by the microprocessor as a result of the respective two pushbuttons having previously been depressed - will light up.

The “cycle phase displays” will show, by lighting up, all phases that make up the selected cycle.

The various combinations, obtainable by depressing the “fabric” and “colour fastness” selectors, constitute the basic cycles, described in the relevant chart.

If so desired, the characteristics of a given wash cycle can be modified by depressing the following pushbuttons:

“Heavy soil”;

“1/2 load”;

“Spin”;

“Temperature”;

according to the procedure described under chapter “Controls description”.

Adding the Washing Powder

The wash powder and the additives should be loaded into the respective compartments of the detergent dispenser before the wash cycle is started.

It is very important to use a low lather powder such as Persil Automatic or Ariel Automatic.

Open the dispenser (Fig. 8) by depressing the push button.

The washing powder for the prewash should be put into compartment “a”.

The powder for the main wash should be put into compartment “b”.

Compartment “c” is for liquid fabric conditioners, starching, blueing, or softening products. For quantities to be used please follow the manufacturers instructions and never fill the compartment above the filter screen.

If this levels is exceeded, the liquid additive is wasted because it flows directly into the wash tub and could originate cloggings inside the machine.

To get your clothes really clean it is essential that enough powder is used in the machine. The correct amount will depend on a number of things: the hardness of the washes, we suggest you follow the table below and adjust the amounts according to your personal experience. You may find it helps to use a measuring cup at first.

If you note an excessive formation of lather during washing or rinsing, it will be advisable to reduce the quantity of wash powder to prevent a faulty operation of the washing machine.

Small Load or Light Soiling	Full Load or Heavy Soiling
Soft Water 1 Cup	Soft Water 1 - 2 Cups
Hard Water 1 - 2 Cups	Hard Water 2 - 2.5 Cups

Which powder?

Do not use ordinary powders in your new washing machine as these powders produce so much lather that clothes are prevented from tumbling freely and cannot get properly clean. Do use the right powder. For best results we recommend using Ariel Automatic and Persil Automatic.

Like all modern automatic machines the ZE 2002 IS works at peak efficiency with a low lather product. These products' balanced lather is specially designed to complement the cleaning action of the machine.

So use it regularly for trouble free washing and good results.

If liquid instead of powder detergents are to be used, do use the special cups that come with the machine. These cups should be fitted into the appropriate compartments of the detergent dispenser (Fig. 9), making sure that the small syphon pipe is firmly inserted in its seat. The smaller cup goes into the left compartment.

For quantities of liquid detergent to be used, follow the manufacturer's recommendations. Do not exceed the level R (Fig. 9) on the inside of the cups.

Empty the dispenser cups of water at the end of a wash cycle if there is any water left in them.

Starting the wash cycle

After loading the clothes, selecting the wash cycle and adding the wash powder, depress the "START" button to get the wash cycle under way.

Once the cycle is started, only the display showing the cycle phase in progress in addition to pilot lamp A - remains lit.

If the "cycle START button" is depressed while a wash cycle is being carried out, you can again visualize on the displays all characteristics of the cycle in progress.

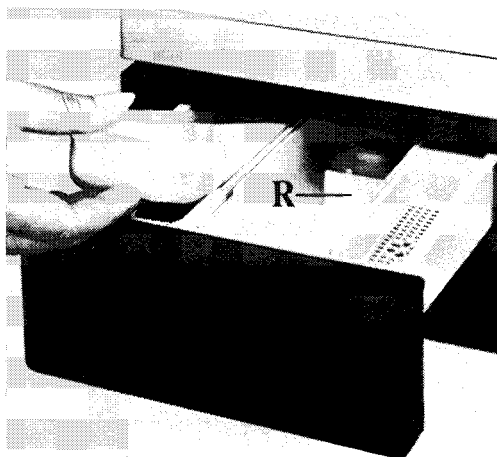

Fig. 9

Interrupting a cycle in progress

You can at any given moment interrupt a cycle in progress by depressing the "ON/OFF" pushbutton.

If you depress it again, the cycle will resume exactly from the point where it was interrupted.

If during a wash cycle there is a power failure, the machine will resume normal operation as soon as the electric power is restored (up to a maximum of about 2 weeks).

If you wish to cancel the wash cycle in progress, you should keep the "FORWARD" button depressed until the end-of-cycle sound signals are heard. After that, turn the machine off and then on again (pushbutton ON/OFF) to enter the new wash cycle.

End of cycle

When the wash cycle is completed and all "cycle phase" displays go out, the washing machine stops automatically and signals that the wash cycle is finished with two brief sound signals.

At this point, depress the "ON/OFF" pushbutton.

Wait 1-2 minutes after the end of the wash cycle before opening the loading door, so as to allow the safety interlock - which locks the door during the wash cycle - to become disconnected.

At the end of the wash cycles for "Synthetics" or "Delicates", water is not drained to prevent crease formation in case the laundry is left in the machine at the end of the cycle.

The presence of water in the tub is shown by the "drain"  display which flashes; to drain the water, simply depress the "START" button.

Finally, it is always advisable to unplug the machine from the wall socket and to turn off the water tap.

Helpful tips

To solve your laundry problems and help you obtain in the best washing results, here are some practical hints.

Sort your laundry by type of fabric and colour fastness.

This will make it much easier for you to select the appropriate wash cycle.

When selecting the wash programme, also take into account the indications given on the textile care labels to be found on all garments.

Always make sure you have loaded your laundry before you start the programme.

Avoid machine-washing articles without a hem or which tend to fray; close all zippers; collect small items in a cotton bag.

Use only good quality wash powders specially made for automatic washing machines.

To ensure good washing results with synthetic and mixed (blended) fabrics, it is advisable not to load more than 1,5 - 2 kg at a time (that is: per single wash cycle).

When washing articles made from absorbent cloth (bath-towels etc.), we advise you to reduce your load correspondingly since towelling soaks up a lot of water.

For woollens use "neutral" (i.e.: mild) wash powders and, to ensure good washing results, do not wash more than 1 kg. of woollens at a time.

As was already pointed out, the "wool"  programme stored in this washing machine is a special wash cycle for wool garments bearing the IWS woolmark label "Pure New Wool - washing shrink resistant".











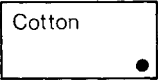
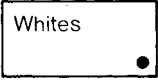

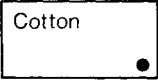
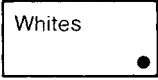
Basic wash cycles

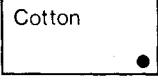
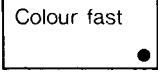

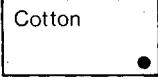
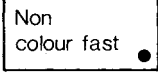

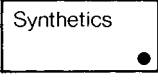
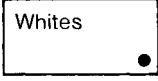

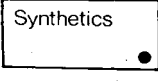
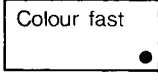

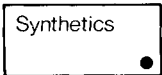
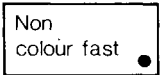

Important: on these basic wash cycles, it is possible to intervene by depressing pushbuttons 4-5-6-7 to adapt the programme to one's own washing requirements. In this connection, please refer to chapter "Controls description", paragraphs 4-5-6-7.

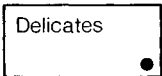
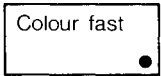
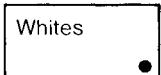
Always remember:

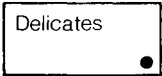
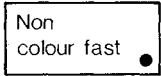
1. before you select a programme, depress pushbutton "ON/OFF" to turn the machine live;
2. prior to starting the programme, fill the wash powder and the additives-if any- into the respective compartments of the detergent dispenser.

Recommended wash load: for cotton, linen and hemp 10 lbs (4.5 Kgs) max; for synthetics, delicates and blended fabrics 3-5 lbs (1.5 = 2 Kgs) max; for wool 2 lbs (1 Kg) max.

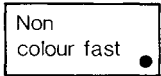
Wash cycle		ITCLC cycle symbol	Wash cycle description
(fabrics)	(colours)		
			Main wash in water at 90 °C. 4 cold water rinses. Final spinning.
If the washing temperature is reduced to 60 °C in this programme, the microprocessor will keep the wash cycle duration unchanged. In this way, when washing clothes having no "difficult" stains, it will be possible to obtain a substantial saving in electricity consumption with good washing results all the same.			
			Main wash in water at 90 °C. 4 cold water rinses. No spin.
Prior to starting the programme, push the "Spin" button (6) to cut out the spinning phase.			
			Main wash in water at 60 °C. 4 cold water rinses. Final spinning.
			Main wash in water at 40 °C. 4 cold water rinses. Final spinning.
			Main wash in water at 60 °C. 3 cold water rinses. Stop with water in tub  . To drain depress again button "START".
			Main wash in water at 50 °C. 3 cold water rinses. Stop with water in tub  . To drain depress the "START" button again.



Wash cycle		ITCLC cycle symbol	Wash cycle description
(fabrics)	(colours)		
			Main wash in water at 40 °C. 3 cold water rinses. Stop with water in tub  . To drain depress the “START” button.
	 or 		Main wash in water at 40 °C. 3 cold water rinses. Stop with water in tub  . To drain depress the “START” button again.
			Main wash in water at 30 °C. 3 cold water rinses. Stop with water in tub  . To drain depress the “START” button again.
			Main wash in water at 35 °C. During water heating the drum remains stationary. 3 cold water rinses. 1 minute final spin.

The “Wool”  programme is a special wash cycle for wool garments bearing the IWS woolmark label “Pure New Wool” - washing shrink resistant; therefore, with this cycle it makes no difference which of the “colour fastness selector” buttons is depressed.

Special cycles



Energetic rinses - Energetic spin

Immediately after starting a wash cycle for cotton fabrics, depress the “FORWARD” button until the following displays light up:

- The rinse display  , if you wish to carry out a wash cycle including 4 energetic rinses and a 6-minute long final energetic spin.
- The spin display  , if you only wish to carry out a 6-minute long energetic spin.

Gentle rinses - Gentle spin

Immediately after starting a wash cycle for synthetic fabrics, depress the “FORWARD” button displays light up:

- The rinse display  , if you wish to carry out 3 gentle rinses. After the last rinse, the drain display flashes to remind you that when the wash cycle is completed you should drain the water by depressing button “START”; a short 1-minute spin follows;
- The spin display  , if you only wish to carry out a short 1-minute spin.

Care & Cleaning

Cleaning the machine

Important: Make sure that the plug has been removed from the socket prior to undertaking any kind of maintenance.

It is advisable, from time to time, to carry out a complete wash cycle without any laundry adding 25g (1 oz) of "Calgon".

After every wash cycle, leave the door open for a while to allow air to circulate freely inside the machine.

The cabinet should be cleaned with a lukewarm solution of mild soap and then rinsed and dried thoroughly.

All polished, chromium plated and plastic parts should only be cleaned with a damp cloth.

It is also advisable to clean the detergent dispenser every so often. The drawer can be removed from the front of the appliance by giving a sharp pull outwards, and then washed under running water.

A sharp tap may be necessary when replacing the drawer.

Cleaning the drain filter

This washing machine incorporates a mechanical filter to collect lint and small objects inadvertently left in the clothes. If this filter is allowed to clog, it could make water draining difficult.

It will therefore be necessary to clean this filter at regular intervals. To do this, proceed as follows: remove the front bottom panel from the cabinet by pulling it out from underneath; drain all remaining water as shown in Fig. 10; using the spanner that comes with the machine, unscrew and remove the filter (Fig. 10-11); clean the filter thoroughly and then replace it, screwing the cap tight.

When replacing the filter, be sure to fit it exactly into its special guide.



Fig. 10

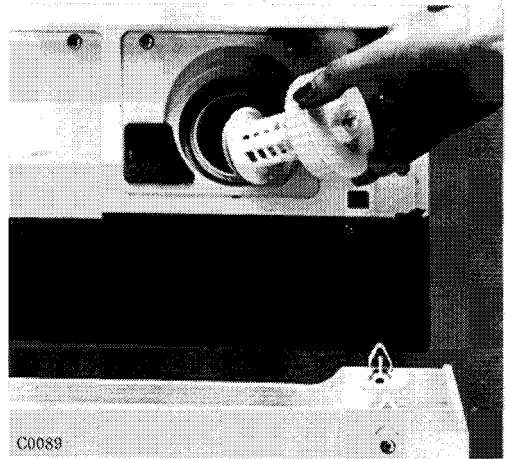

Fig. 11

Instructions for matching to kitchen environment

Instructions for doors reversal

It is possible to reverse the door opening direction on this washing machine. To carry out this operation, proceed as follows:

- a) Bend and disengage from the door the end of the closing catch (1-Fig. 12), then rotate it 90 °C to remove it from its seating;
- b) Using a screwdriver, rotate the plastic cap (2- Fig. 12) 90° and remove it;
- c) Fit the cap (2-Fig. 13) in the hole left free by the closing catch and rotate it 90° so as to lock it in position;
- d) Fit in and rotate 90° the closing catch (1-Fig. 13) in the hole left free by the cap, making sure that the engaging tooth is facing towards the right side;
- e) Remove the machine's panel by pulling it outwards from underneath;
- f) Remove the door by unscrewing the two screws fastening the bottom hinge (3-Fig. 12). Keep hinge for possible future use if it is required to return to original door opening direction;
- g) Remove the stop hook (4-fig. 12) after having removed the fixing screws from the cabinet. Take out stud 5 (fig. 12) pulling it outwards from the bottom and

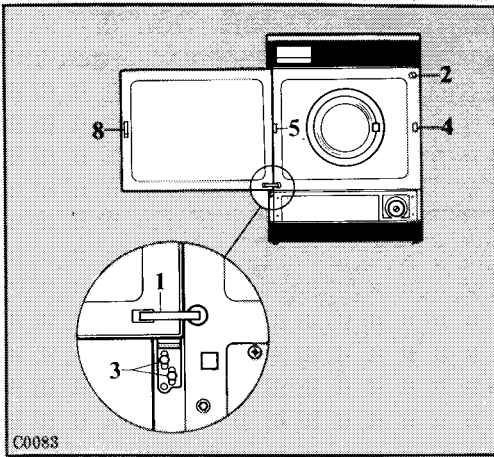

C0083

Fig. 12

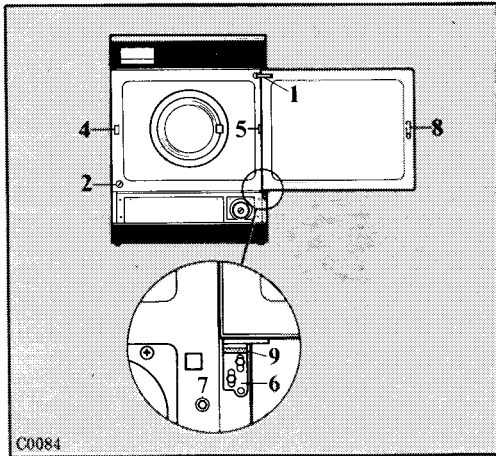

C0084

Fig. 13

then rotate it of 90°. Refit the stop hook (4-Fig. 13) and stud 5 (fig. 13) on the opposite side.

Displace door closure (8 fig. 12) bending the two fastening wings in the direction of the arrows on the closure itself. Turn the closure upside down and push it till fastening of the two wings.

h)

Fasten the door on the opposite side by means of hinge (6-Fig. 13) provided as an attachment and using the two previously removed screws.

Check the door is aligned with the cabinet; to make this operation easy, it may be advisable to loosen by two turns the screws (7-Fig. 13) provided next to the hinge's fastening holes, then tighten the screw again.

i)

Fit on the hinge's bottom portion (6-Fig. 13) the adhesive bearing (9-Fig. 13) provided as an attachment so as to avoid scratches on bottom panel;

i)

Fit into seating provided on the door the flexible end of the door closing catch (1-Fig. 13).

Instruction for application of decorative paneling on door and on bottom panel

The door and the bottom panel of this washing machine are provided with appropriate frames which enable application of decorative panels (stainless steel sheet, plastic sheet, wood, etc.) so as to match washing machine's appearance with that of remaining kitchen furniture.

The overall dimensions of the decorative panels should be as follows:

For the door:

Width	587 mm
Height	461 mm
Max. Thickness	4 mm

For bottom panel:

Width	587 mm
Height	114 mm
Max. Thickness	4 mm

To apply it to the door, remove the door frame from the side fixed to the pivots and release the peripheral fastening screws.

Fit the decorative panel and then reassemble all parts taking care to make frames adhere to the decorative panel.

To apply it to the bottom panel, remove the panel by pulling it, from the underneath outwards, remove the frame, apply the decorative sheet and then refit all parts.

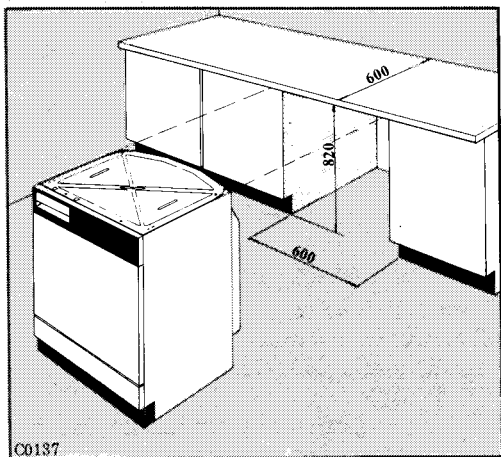

C0137

Fig. 14

Building-in directions

This washing machine can easily be built into any fitted kitchen thanks to its standard dimensions:

Height 85 cms.

Width 60 cms.

Depth 60 cms.

To fit it under a kitchen counter, into a recess having the dimensions shown in Fig. 14, you should first replace the work-top of the machine with a security plate which is available as an optional extra.

The instructions for building-in are enclosed with the security plate.

Something not working

If your machine does not work properly, this might be due to some minor fault that can easily be eliminated by going through the following steps.

If the pilot light  doesn't light up after the machine has been switched on, check:

- that the plug is firmly in the wall socket and there is an electricity supply (by plugging in another appliance);
- that the fuses of your electrical installation have not blown.

If the "Alarm" light flashes continuously when the machine is switched on, turn the appliance off and contact your nearest Zanussi Service Centre.

If the "Alarm" light starts flashing after the programme has started, turn the machine off and check:

- that the loading door is firmly closed;
- that the drain filter is not clogged;
- that the water tap is actually turned on and there is sufficient pressure;
- that the fill and drain hoses are not sharply bent (kinked) or squashed to the point of obstructing a normal water flow;
- that the end of the drain hose is not placed too low from the floor level (min. 60 cms).

If during operation the machine vibrates or is too noisy, check:

- that the inner packing (transit security) was correctly removed, as described in paragraph "Unpacking".
- that the washing machine is correctly levelled as described in the relevant paragraph;
- that the appliance is not too close to a wall or to the furniture.

If the malfunction persists after all preceding checks are carried out, you should definitely contact our nearest Service Centre.

Servicing & spare parts

Prior to leaving the plant, this appliance was thoroughly tested and painstakingly calibrated by expert engineers in order to ensure the best possible performance.

If any servicing or adjustment should later become necessary, make sure this is carried out solely by the local Zanussi Service Agent.

Also, if parts are replaced during a repair job, make sure these are genuine Zanussi Parts.



ZANUSSI STANDARD GUARANTEE CONDITIONS

This guarantee is in addition to your statutory and other legal rights which will not be excluded or in any way diminished by the return of the guarantee card.

We, IAZ International (UK) Ltd, undertake that if, within twelve months (24 months for TV sets) of the date of the purchase, this ZANUSSI appliance or any part thereof is proved to be defective by reason only of faulty workmanship or materials, we will, at our option, repair or replace the same **FREE OF ANY CHARGE** for labour, materials or carriage on condition that:

—The appliance has been correctly installed and used only on the electricity supply stated on the rating plate.

—The appliance has been used for normal domestic purposes only, and in accordance with the manufacturer's operating and maintenance instructions.

—The appliance has not been serviced, maintained, repaired, taken apart or tampered with by any person not authorised by us.

—The appliance is still in the possession of the original purchaser.

All service work under this guarantee must be undertaken by a Zanussi Network Service Centre (or the Zanussi Authorised TV Service Dealer).

Any appliance or defective part replaced shall become our property.

Exclusions

This guarantee does not cover:

—Damage or calls resulting from transportation, improper use or neglect, the replacement of any light bulbs or removable parts of glass or plastic.

—Costs incurred for calls to put right machines improperly installed or calls to machines outside the UK and the Republic of Ireland.

—Appliances found to be in use within a commercial environment, plus those which are the subject of rental agreements.

—Television receivers - routine adjustment, or poor reception resulting from a source outside of the receiver.



ZANUSSI 5 YEAR COVER CONDITIONS

For a once-only payment you can extend your Standard Guarantee to 5 years. All the conditions and exclusions of the Standard Guarantee apply.

Notes

1. Products supplied as "seconds", refurbished, damaged or shop-soiled are not eligible for Zanussi 5 year cover.
2. The issue of a cover does NOT by virtue of our having done so, nullify the exclusions.
3. The Engineer will need to check the details of your Cover card and may make a charge for his services if it is not presented to him at the time of his call.
4. The date of purchase, or the date of initial payment (deposit) of the appliance will be deemed the date of commencement of cover.
5. Covers issued are not refundable or transferable.

ZANUSSI

The appliance of science