

use & care guide

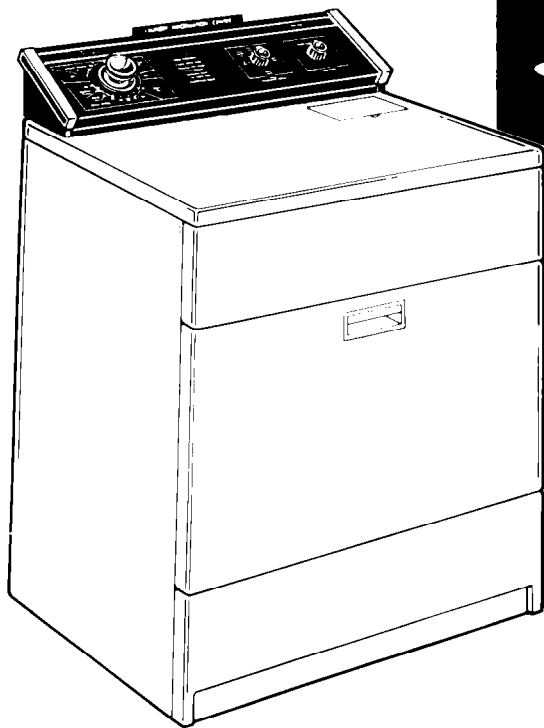

**Whirlpool**

AUTOMATIC DRYERS

**Electric Model
LE7010XP
and
Gas Model
LG7011XP**

Wave Ovens, Trash Compactors, Room Air Conditioners, Dehumidifiers, Automatic Washers, Clothes Dryers, Freezers, Refrigerator-Freezers

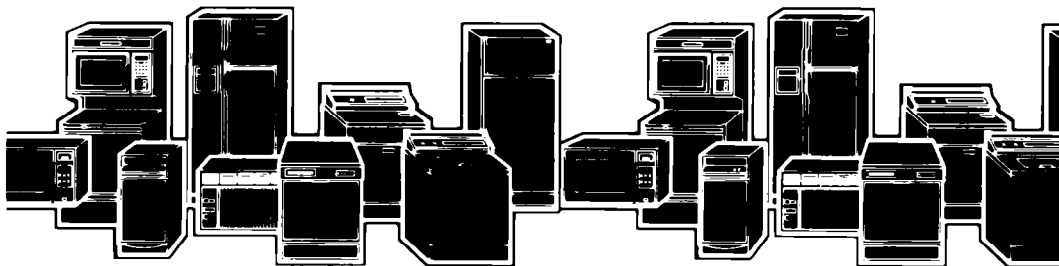

Parts and features

CYCLE CONTROL KNOB

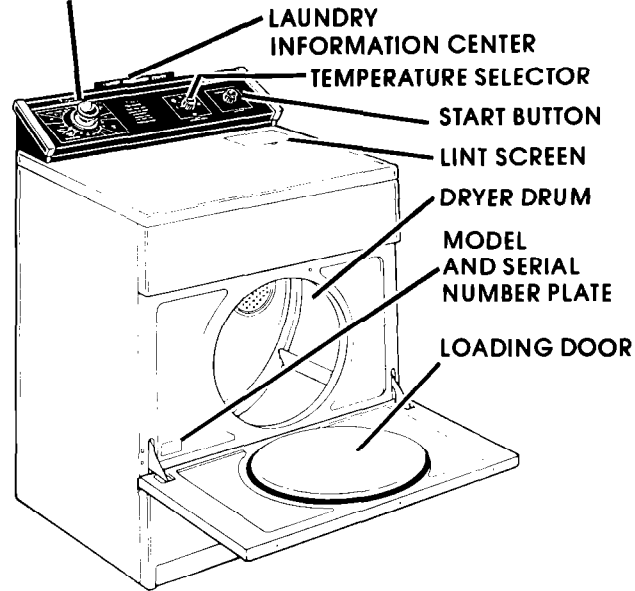

Remove the Consumer Buy Guide label before using your dryer. It will be easier to remove.

Wipe out the dryer drum with a damp cloth to remove dust from storing or shipping.

Copy your Model and Serial Numbers here

When you need service or call with a question, have this information ready:

1. **Complete** Model and Serial Numbers (from the plate located as shown).
2. Purchase date from sales slip.

Copy this information in these spaces. Keep this book, your warranty, sales slip and "Dryer Guide" in the Laundry Information Center on the back of the dryer console.

Complete Model Number

Complete Serial Number

Purchase Date

Service Company and Telephone Number

Contents

	Page	Page	
PARTS AND FEATURES	2	End-of-Cycle Signal	8
YOUR RESPONSIBILITIES	3	Lint Signal	8
SAFETY FIRST	3	LINT SCREEN	9
SELECTING A CYCLE AND		LINT REMOVAL	9
STARTING YOUR DRYER	4	CARING FOR YOUR DRYER ...	10
OPERATING INSTRUCTIONS ..	6	Cleaning Dryer Interior	10
The Automatic Cycles	6	Vacation Care	10
Timed Drying	6	IF YOU NEED SERVICE OR	
DRYING TIPS	7	ASSISTANCE	11
FLUFF AIR Setting	7	1. Before Calling for	
TUMBLE PRESS® Setting	7	Assistance	11
Gentle Heat	7	2. If You Need Assistance ...	11
Drying Times	8	3. If You Need Service	11
Mixed Loads	8	4. If You Have a Problem ...	11

Your Responsibilities

Read this "Use and Care Guide" and your "Dryer Guide" carefully for important use and safety information.

You are personally responsible for making sure that your dryer...

- is installed by a qualified installer.
- is properly maintained.
- is installed in an area protected from the weather.
- is properly installed and leveled in a well ventilated room* on a floor that can support the weight.

- is located in an area where the temperature is above 45°F (7.2°C).
 - is connected to the right kind of outlet, electric supply and grounding.*
 - is properly connected to fuel and exhaust systems.*
 - is used only for jobs normally expected of home clothes dryers.
 - is not run where there may be explosive fumes.
 - is not used by children or anyone unable to operate it properly.
- *See the "Installation Instructions" for complete information.

Safety first

ALWAYS unplug the power supply cord or turn off electrical power before attempting to service the dryer. **Shut off the GAS VALVE** if yours is a gas dryer.

ALWAYS shut off the gas valve before leaving on vacation.

NEVER use flammable fluids (dry-cleaning solvents, gasoline, kerosene) in or near your dryer.

ALWAYS hand launder or air dry fabrics treated with flammable fluids before putting them into your dryer.

NEVER dry items containing wax or paint in the dryer. The fumes can create a **FIRE HAZARD**.

FIRE HAZARD and **DAMAGE** to some materials can result from:

- drying heat-sensitive materials with heat (see page 4).
- operating the dryer with the lint screen loose, damaged or missing.
- allowing lint to build up inside the dryer (see page 9).

NEVER allow children to operate, play with, or crawl inside the dryer.

NEVER operate the dryer if...

- it is not working right.
- it is damaged.
- parts are missing.
- all panels are not in place.

DO NOT let dust, lint, paper, rags, chemicals, etc., pile up around or under the dryer. **DO NOT** install against drapes or curtains.

• FOR YOUR SAFETY •

IF YOU SMELL GAS:

1. OPEN WINDOWS.
2. DON'T TOUCH ELECTRICAL SWITCHES.
3. EXTINGUISH ANY OPEN FLAME.
4. IMMEDIATELY CALL YOUR GAS SUPPLIER.

• FOR YOUR SAFETY •

DO NOT STORE OR USE GASOLINE OR OTHER FLAMMABLE VAPORS AND LIQUIDS IN THE VICINITY OF THIS OR ANY OTHER APPLIANCE.

• SAVE THESE INSTRUCTIONS •

Selecting a cycle and starting your dryer

Before starting your dryer, be sure laundry is sorted and loaded properly (see your "Dryer Guide"). **Be sure the door is tightly closed.**

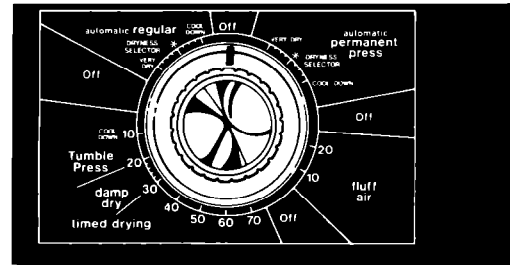

TYPE OF LOAD	SUGGESTED CYCLE	SUGGESTED TEMPERATURE
COTTONS – LINENS		
EXTRA HEAVY – Bedspreads, mattress pads, quilts.		HEAVY HIGH
HEAVYWEIGHT FABRICS – Towels, jeans, corduroys, work clothes	AUTOMATIC REGULAR	PERM'T PRESS MED
MEDIUMWEIGHT COTTONS – Sheets, pillowcases, cotton underwear, diapers		
LIGHTWEIGHT COTTONS – Batistes, organdies, lingerie		KNITS GENTLE LOW
PERMANENT PRESS, SYNTHETICS AND BLENDS		
HEAVYWEIGHT FABRICS – Work clothes, jackets, raincoats	AUTOMATIC PERMANENT PRESS	PERM'T PRESS MED
MEDIUMWEIGHT FABRICS – Shirts, play clothes, sheets, slacks		
LIGHTWEIGHT FABRICS – Lingerie, blouses, dresses		MED LOW
KNITS		
HEAVYWEIGHT – Cottons, rayons, blends, T-shirts, slacks, shirts	AUTOMATIC PERMANENT PRESS	MED LOW
LIGHTWEIGHT – Synthetics (polyester, acrylic, etc.) and blends, lingerie, blouses, dresses		KNITS GENTLE LOW
LIGHTWEIGHT AND DELICATE FABRICS		
Sheer Curtains (2 or 3 panels)	AUTOMATIC PERMANENT PRESS	EX LOW
Gauze, lace, etc.		
RUBBER, PLASTIC, HEAT-SENSITIVE FABRICS		
FOAM RUBBER – Pillows, bras, stuffed toys	20-30 MINS.	FLUFF AIR
PLASTIC – Shower curtains, tablecloths	20-30 MINS.	
RUBBER-BACKED RUGS	40-50 MINS.	
OLEFIN, POLYPROPYLENE, SHEER NYLON ..	15-20 MINS.	
WARNING: Drying these and other heat-sensitive materials with heat can damage them or be a FIRE HAZARD.		

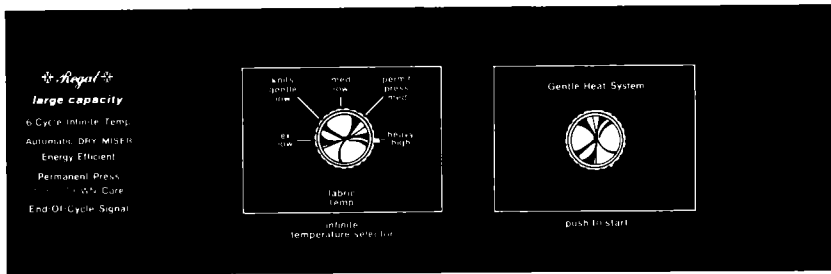

1. CYCLE

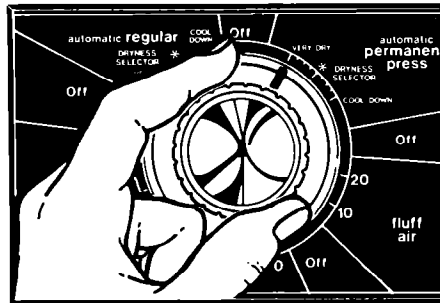

Turn the Control Knob either way to point to the cycle and setting you want. See page 6 for information on the cycles.

2. SET TEMPERATURE SELECTOR

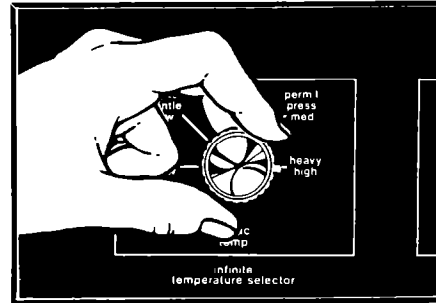

The Temperature Selector can be set on any desired temperature or anywhere between 2 temperatures.

3. START Button

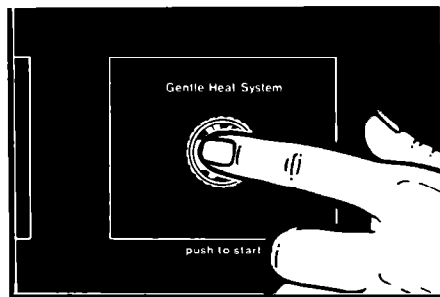

The dryer will start tumbling when you push the START Button.

To stop and restart the dryer

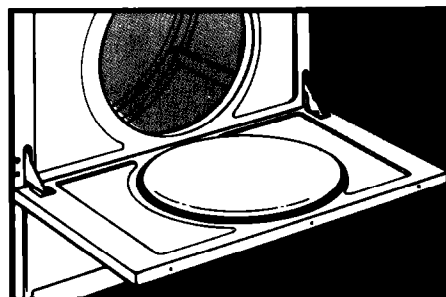

To stop the dryer, open the door (or turn the Control Knob to OFF).
To restart the dryer, close the door, select cycle, if necessary, and push START.

The Cycle Control Knob should point to OFF when the dryer is not in use.

Operating instructions

The automatic cycles

The automatic cycles allow you to select the degree of dryness you prefer for the clothes being dried.

The Control Knob moves and stops several times until the load reaches the dryness setting you selected. Then the knob automatically moves to OFF and tumbling stops.

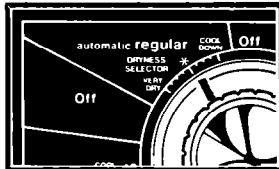

Use **AUTOMATIC REGULAR** to dry heavy and medium-

weight cotton items. **The load tumbles without heat during the last 5 minutes.** This helps make the load easier to handle.

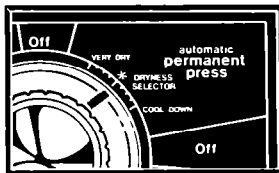

Use **AUTOMATIC PERMANENT PRESS** to dry permanent

press, knits and other synthetic fabrics. **The load tumbles without heat during the last 10 minutes.** This helps keep wrinkles from setting in.

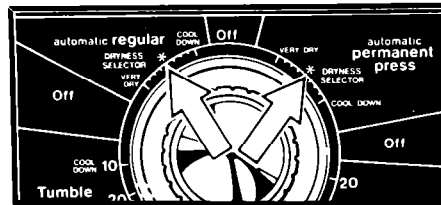

For the first few loads, set the Control Knob to point to an * in either automatic cycle. When the dryer stops, feel the dried items.

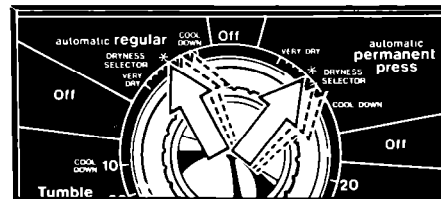

- If items are drier than you like, use a setting to the right of the * the next time you dry a similar load.

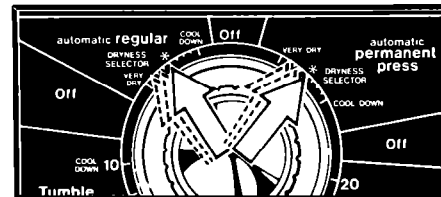

- If items are not as dry as you like, use a setting to the left of the * the next time you dry a similar load.

OVERDRYING CAN CAUSE SHRINKAGE, STATIC CLING AND DAMAGE TO SOME FABRICS.

Timed drying

Use the **TIMED DRYING** Cycle for any load you want to dry by time. For example: small loads, large bulky items, items to be fluffed or dusted with the **FLUFF AIR** heat setting.

- Turn the Control Knob to the number of minutes you want – from 10 to 70.
- The last 10 minutes of this cycle are without heat – a cool-down time. This helps make the load easier to handle.

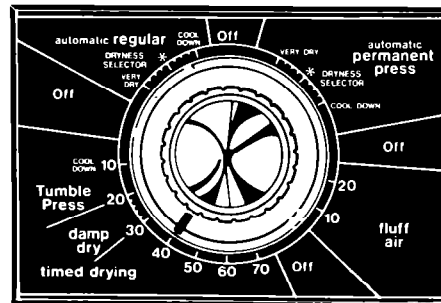

Drying tips

FLUFF AIR

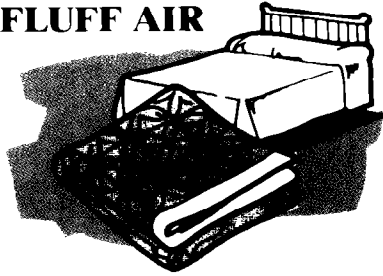

The dryer does not heat when the Control Knob is set on FLUFF AIR. This setting can be used to fluff bedding, plastic tablecloths, foam rubber pillows, stuffed toys, sneakers, etc.

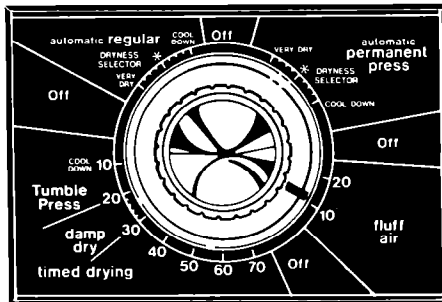

1. Turn the Control Knob to the number of minutes you want in FLUFF AIR.
2. Push the START Button.



WARNING: Drying plastic or rubber items with heat may damage the items or be a FIRE HAZARD.

TUMBLE PRESS® Setting

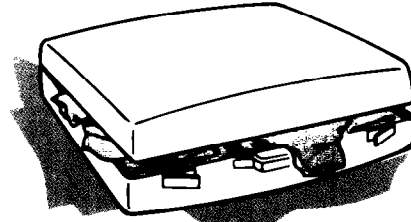

The TUMBLE PRESS setting removes wrinkles from dry clothing such as items that may have been packed in a suitcase, closet, or items not removed from the dryer.

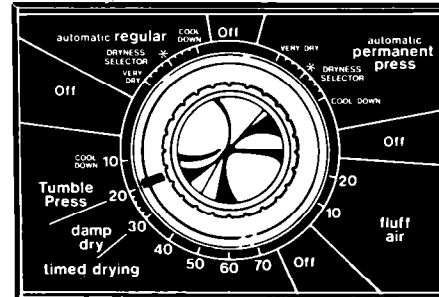

1. Set Control Knob to TUMBLE PRESS.
2. Set Temperature Selector to PERM'T PRESS / MED.
3. Push START Button.

The load will tumble in heated air for 10 minutes. The heat shuts off and the dryer continues to tumble the load for 10 more minutes.

For best results, TUMBLE PRESS only a few items at a time. Put them on hangers or fold them as soon as the dryer stops.

Gentle Heat

The dryer automatically reduces the heat setting in HEAVY HIGH and PERM'T PRESS MED cycles. The last 7 minutes of each of these cycles gradually reduces the dryer temperature to a lower heat setting. This helps prevent over drying.

Drying times

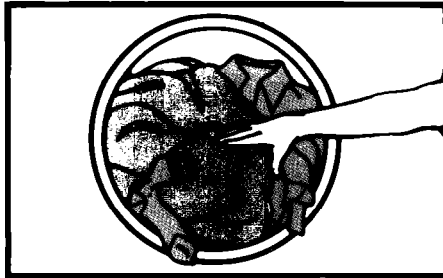

Drying times will vary depending on:

- amount of moisture in the clothes.
- type and weight of the fabric.
- size of the load.
- room temperature around the dryer.
- temperature of the wash rinse water.
- amount of lint in the lint screen.
- dryer temperature selection.

See page 6 in your "Dryer Guide" for more information.

Mixed loads

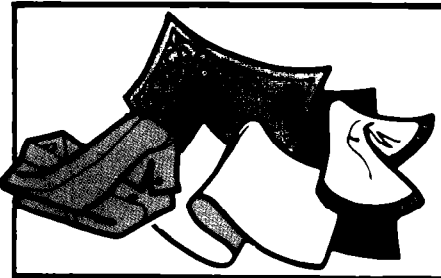

When drying a load with different kinds and weights of fabrics, use the cycle suggested for the lightest fabrics. When the dryer stops, remove dry items and reset the control.

End-of-cycle signal



The dryer sounds a signal to let you know when the cycle is finished. The signal cannot be turned off and is not adjustable.

The signal is helpful when you are drying permanent press, synthetics and other items that should be taken out as soon as the dryer stops.



Lint signal

Clean lint screen **before each load**. If you neglect to clean your lint screen, the signal will sound. The (whistle tone) signal lets you know the air flow is being restricted. Restricted air flow reduces drying efficiency.

Turn off the dryer and clean the lint screen as shown on page 9.

Lint screen

Clean the lint screen before each load. A screen blocked by lint can increase drying time and may be a FIRE HAZARD.

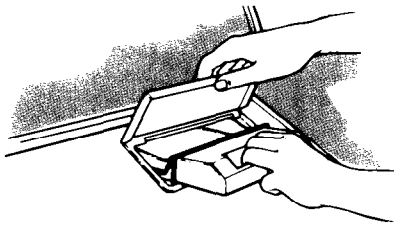

Open the lid and pull the lint screen straight out.

WARNING: DO NOT run the dryer with the lint screen loose, damaged or missing. Doing so can cause overheating, can damage fabrics and can be a **FIRE HAZARD**.

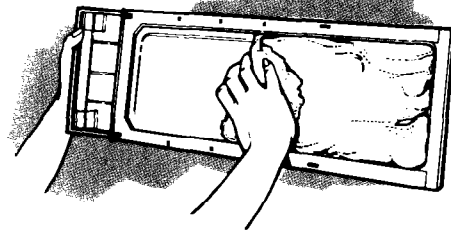

ROLL the lint off the screen with your fingers.

DO NOT rinse or wash the screen.

Push the screen firmly back into place.

Lint removal

Lint can gather inside the dryer and create a fire hazard. **This lint should be removed every 2 to 3 years, or more often, depending on dryer usage.**

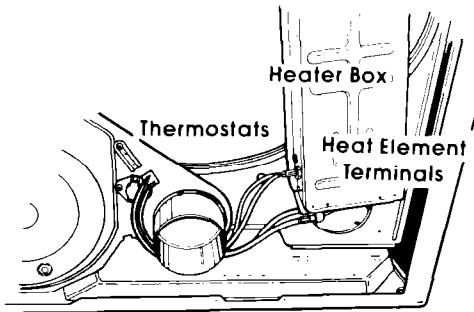

ELECTRIC DRYERS

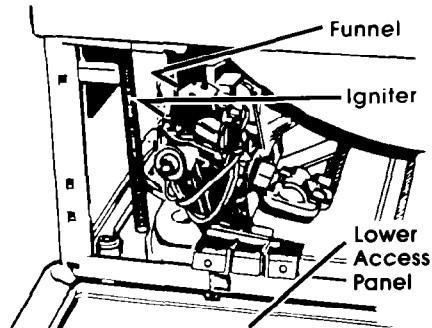

GAS DRYERS

Cleaning should be done only by a qualified person.



WARNING:

- **Avoid electrical shock hazard – unplug power supply cord or turn off electrical power.**
- **Avoid injury or damage – do not put hands inside cabinet.**
- **Make sure dryer is cool.**

1. Remove back panel (electric) or lower access panel (gas).
2. Avoid damaging wires, thermostats, funnel or igniter.
3. Remove lint from shaded area – see art – with a soft brush or vacuum cleaner.
4. Replace panel; reconnect and re-level dryer.

Caring for your dryer



Remove loose and sharp objects from pockets and cuffs before drying – pins, buckles, etc. **Close metal zippers.**

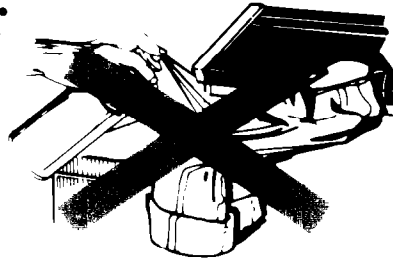

Some pretreatment products can damage dials, consoles and finish. Do not use these products on or near your dryer.



Wipe off all spills with a damp, soft cloth. Spills allowed to remain may dull or damage the finish.

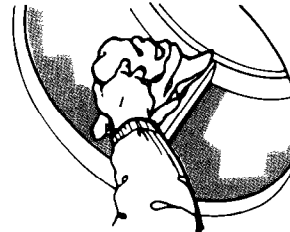

Cleaning dryer interior

WARNING: Before cleaning interior, unplug power supply cord, or turn off electrical power to avoid electrical shock hazard.

Garments which contain unstable dyes, such as denim blue jeans or brightly colored cotton items, may discolor the dryer interior. If the interior is discolored, clean with one of the following methods to avoid staining later load items.

Powdered laundry detergent and very warm water

Make a paste with detergent and very warm water. Apply paste to a soft cloth and scrub area until all excess dye is removed. Wipe thoroughly with a damp cloth. Tumble a load of rags. –OR–

Liquid spray household cleaner

Spray on stained area. Rub with a cloth until all excess dye is removed. Tumble a load of rags.



Never leave wet or damp laundry in your dryer.

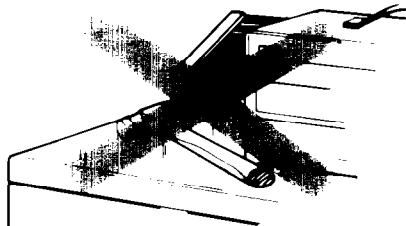

Sharp or heavy objects should never be put on or in the dryer. Check pockets for bolts, nuts, etc.

Vacation care

- Unplug power cord or turn off electrical power.
- For gas dryers, close gas valve.
- Clean lint screen.

If you need service or assistance, we suggest you follow these four steps:

1. Before calling for assistance...

Performance problems often result from little things you can find and fix yourself without tools of any kind.

If your dryer does not run:

- Is the power supply cord plugged into a live circuit with the proper voltage?
- Is the door closed tightly?
- Did you push the START Button?
- Have you checked your home's main fuses or circuit breaker box?

If your dryer does not heat:

- The AIR setting is without heat.
- The last minutes of heat settings are without heat.
- Is the gas turned on? If not, turn the Control Knob to OFF. Turn on gas. Wait 5 minutes. Reset controls and start.
- An electric dryer uses a circuit breaker or 2 fuses. If one fuse is blown, the dryer may run, but not heat.

If drying time seems long:

- Is the lint screen clean?
- See page 7 of this book and page 6 of your "Dryer Guide."

2. If you need assistance*...

Call Whirlpool COOL-LINE® service assistance telephone number. Dial free from:

Continental U.S. . (800) 253-1301
 Michigan (800) 632-2243
 Alaska & Hawaii (800) 253-4124

and talk with one of our trained Consultants. The Consultant can instruct you in how to obtain satisfactory operation from your appliance or, if service is necessary, recommend a qualified service company in your area.

3. If you need service*...



Whirlpool has a nationwide network of franchised TECH-CARE® Service Companies. TECH-CARE

service technicians are trained to fulfill the product warranty and provide after-warranty service, anywhere in the United States. To locate TECH-CARE service in your area, call our COOL-LINE service assistance telephone number (see Step 2) or look in your telephone directory Yellow Pages under:

APPLIANCES - HOUSEHOLD - MAJOR - SERVICE & REPAIR	OR	ELECTRICAL APPLIANCES - MAJOR - REPAIRING & PARTS
WHIRLPOOL APPLIANCES FRANCHISED TECH-CARE SERVICE		WHIRLPOOL APPLIANCES FRANCHISED TECH-CARE SERVICE
SERVICE COMPANIES		SERVICE COMPANIES
XYZ SERVICE CO 123 Maple	999-9999	XYZ SERVICE CO 123 Maple
		999-9999
OR		
WASHING MACHINES, DRYERS & IRONERS - SERVICING		
WHIRLPOOL APPLIANCES FRANCHISED TECH-CARE SERVICE		
SERVICE COMPANIES		
XYZ SERVICE CO 123 Maple		
999-9999		

4. If you have a problem*...

Call our COOL-LINE service assistance telephone number (see Step 2) and talk with one of our Consultants, or if you prefer, write to:

Mr. Robert Stanley
 Division Vice President
 Whirlpool Corporation
 2000 US-33, North
 Benton Harbor, MI 49022

*If you must call or write, please provide: model number, serial number, date of purchase, and a complete description of the problem. This information is needed in order to better respond to your request for assistance.



Making your world a little easier.

Part No. 696769
©1986 Whirlpool Corporation

Printed in U.S.A.

Automatic Washers, Clothes Dryers, Freezers, Refrigerator-Freezers, Ice Makers, Dishwashers, Built-In Ovens and Surface Units, Ranges, Micro

