

WF-J1461(W/V/S/C/R) WF-R1261(W/V/S/C/R)
WF-J1261(W/V/S/C/R) WF-R1061(W/V/S/C/R)
WF-J1061(W/V/S/C/R) WF-R861(W/V/S/C/R)
WF-J861(W/V/S/C/R) WF-F1261(W/V/S/C/R)
WF-B1461(W/V/S/C/R) WF-F1061(W/V/S/C/R)
WF-B1261(W/V/S/C/R) WF-F861(W/V/S/C/R)
WF-B1061(W/V/S/C/R) WF-S1061(W/V/S/C/R)
WF-B861(W/V/S/C/R) WF-S861(W/V/S/C/R)

Washing Machine user manual

imagine the possibilities

Thank you for purchasing a Samsung product.

To receive a more complete service,
please register your product at

www.samsung.com/global/register



SAMSUNG

safety information

Congratulations on your purchase of this Samsung washing machine. These Owner's Instructions contain valuable information on the installation, use, and care of this appliance. Please take the time to read these instructions so that you can take full advantage of the washing machine's features and enjoy this appliance for many years to come.

IMPORTANT SAFETY SYMBOLS AND PRECAUTIONS

What the icons and signs in this user manual means:

 WARNING	Hazards or unsafe practices that may result in severe personal injury or death.
 CAUTION	Hazards or unsafe practices that may result in minor personal injury or property damage.
 CAUTION	To reduce the risk of fire, explosion, electric shock, or personal injury when using your washer, follow these basic safety precautions:

BEFORE USING THE APPLIANCE



Packing materials can be dangerous to children; keep all packing material (plastic bags, polystyrene, etc.) well out of the reach of children.

The appliance is designed for home use only.

Make sure that water and electrical connections are made by qualified technicians, observing the manufacturer's instructions (see "Installing the Washing Machine") and local safety regulations.

All packaging and shipping bolts must be removed before the appliance is used. Serious damage may occur if they are not removed. See "Removing the shipping bolts".

Before washing clothes for the first time, you must run a complete cycle without clothes. See "Washing for the first time".

SAFETY INSTRUCTIONS



Before cleaning or carrying out maintenance, unplug the appliance from the electrical outlet or set the  (On/Off) button to Off.

Make sure that the pockets of all clothing to be washed are empty. Hard, sharp objects, such as coins, safety pins, nails, screws, or stones can cause extensive damage to the appliance.

Always unplug the appliance and turn off the water after use.

Before you open the door of the appliance, check that the water has drained. Do not open the door if you can still see water.

Pets and small children may climb into the appliance. Check the appliance before each use.

safety information

The glass door becomes very hot during the washing cycle. Keep children away from the appliance while it is in use.

Do not attempt to repair the appliance yourself. Repairs made by inexperienced or unqualified persons may cause injury and/or make more serious repairs to the appliance necessary.

If the plug (power supply cord) is damaged, it must be replaced by the manufacturer or its service agent or a similar qualified person in order to avoid a hazard.

This appliance should only be serviced by an authorized service center, and only genuine spare parts should be used.

This appliance is not intended for use by young children or infirm persons unless they have been adequately supervised by a responsible person to ensure that they can use the appliance safely. Young children should be supervised to ensure that they do not play with the appliance.

This appliance has to be connected to the plug endurable to proper power consumption.

This appliance has to be positioned so that the plug is accessible after installation.

Do not use processed water containing oil, cream or lotion, which is usually found in skin-care shops or massage clinics.

- Otherwise this will cause the packing to be deformed, which causes a malfunction or water leak.

A stainless washing tube does not usually rust. However if some metal such as a hair pin is left in the tube for an extended time, the tube could rust.

- Do not leave water or bleach containing chlorine in the tube for an extended period of time.
- Do not regularly use or leave water containing iron in the tube for an extended period of time.
- If rust starts appearing on the surface of the tube, apply a cleansing agent (neutral) to the surface and use a sponge or soft cloth to clean it. (Under no circumstances use a metal brush)

For washing machines with ventilation openings in the base, that a carpet must not obstruct the openings.

Use the new hose-sets and old hose-sets should not be reused.

contents

INSTALLING THE WASHING MACHINE

5

- 5 Unpacking the Washing Machine
- 5 Overview of the washing machine
- 6 Selecting a location
- 6 Adjusting the leveling feet
- 6 Removing the shipping bolts
- 7 Connecting the water supply hose
- 7 Positioning the drain hose
- 8 Plugging in the machine

WASHING A LOAD OF LAUNDRY

9

- 9 Overview of the control panel
- 10 Washing for the first time
- 10 Putting detergent in the washing machine
- 11 Washing clothes manually
- 11 Selecting options
- 12 Washing tips and hints

MAINTAINING THE WASHING MACHINE

13

- 13 Repairing a frozen washing machine
- 13 Cleaning the exterior
- 13 Cleaning the debris filter
- 13 Cleaning the water hose mesh filter

TROUBLESHOOTING

14

- 14 Problems and solutions
- 14 Understanding error messages

PROGRAMME CHART

15

- 15 Programme chart

APPENDIX

16

- 16 Fabric care chart
- 16 Electrical warnings
- 16 Protecting the environment
- 16 Declaration of conformity
- 17 Specification

installing the washing machine

UNPACKING THE WASHING MACHINE

Unpack your washing machine and inspect it for shipping damage. Also make sure that you have received all of the items shown below. If the washing machine was damaged during shipping or you do not have all of the items, contact your Samsung dealer immediately.

OVERVIEW OF THE WASHING MACHINE

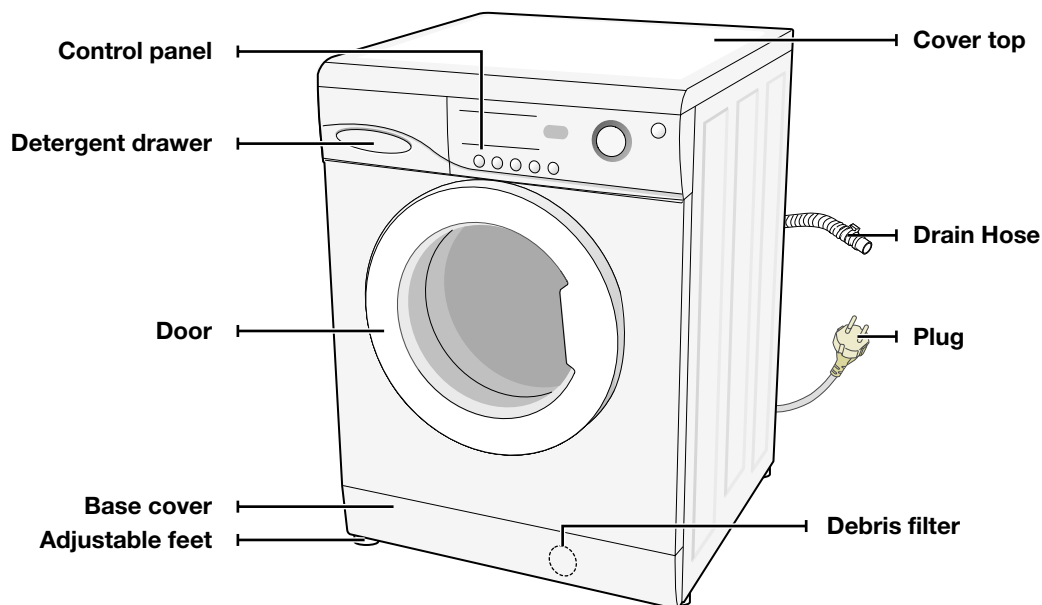

Wrench

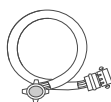

Cold water supply hose



Hose guide

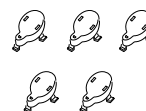

Bolt hole covers

installing the washing machine

SELECTING A LOCATION

Before you install the washing machine, select a location with the following characteristics:

- A hard, level surface (if the surface is uneven, see “Adjusting the leveling feet,” below)
- Away from direct sunlight.
- Adequate ventilation
- Room temperature that will not fall below 0°C
- Away from sources of heat such as coal or gas. Make sure that the washing machine does not stand on its power cord. Ventilation openings must not be obstructed by carpeting when the washing machine is installed on a carpeted floor.

ADJUSTING THE LEVELING FEET

If the floor is uneven, adjust the feet (do not insert pieces of wood or any other objects under the feet):

1. Loosen the leg bolt by turning it with your hand until it is at the desired height.
2. Tighten the locking nut by turning it with the wrench.
 - **Place the washer on a sturdy, flat surface.** If the washer is placed on an uneven or weak surface, noise or vibration occurs. (Only a 1 degree angle is allowed.)

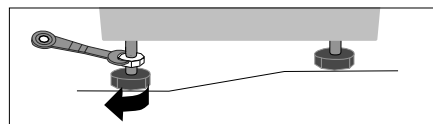

REMOVING THE SHIPPING BOLTS

Before using the washing machine, you must remove all of the shipping bolts from the back of the unit.

To remove the bolts:

1. Loosen all bolts with the wrench before removing them.
2. Take each bolt head and pull it through the wide part of the hole. Repeat for each bolt.
3. Fill the holes with the supplied plastic covers.
4. Keep the shipping bolts for future use.

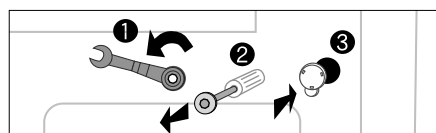

CONNECTING THE WATER SUPPLY HOSE

The water supply hose must be connected to the washing machine at one end and to the water faucet at the other. Do not stretch the water supply hose. If the hose is too short and you do not wish to move the water faucet, replace the hose with a longer, high pressure hose.

To connect the water supply hose:

1. Take the L-shaped arm fitting for the cold water supply hose and connect to the cold water supply intake on the back of the machine. Tighten by hand.
2. Connect the other end of the cold water supply hose to your sink's cold water faucet and tighten it by hand. If necessary, you can reposition the water supply hose at the washing machine end by loosening the fitting, rotating the hose, and retightening the fitting.

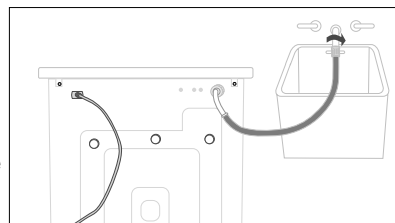

POSITIONING THE DRAIN HOSE

The end of the drain hose may be positioned in three ways:

Over the edge of a sink

The drain hose must be placed at a height of between 60 and 90 cm. To keep the drain hose spout bent, use the supplied plastic hose guide. Secure the guide to the wall with a hook or to the faucet with a piece of string to prevent the drain hose from moving.

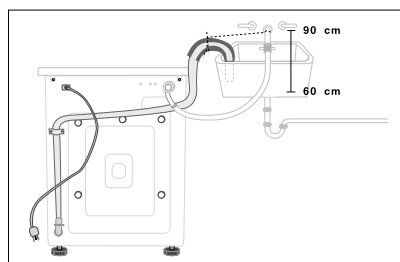

In a sink drain pipe branch

The drain pipe branch must be above the sink siphon so that the end of the hose is at least 60 cm above the ground.

In a drain pipe

Samsung recommends that you use a 65 cm high vertical pipe; it must be no shorter than 60 cm and no longer than 90 cm.

installing the washing machine

PLUGGING IN THE MACHINE

You **MUST** ground the plug of the washing machine.

Check with a licensed electrician before using the machine to make sure it is properly grounded.

For U.K. Users.

Wiring Instructions

- **WARNING THIS APPLIANCE MUST BE EARTHED.**

This appliance must be earthed. In the event of an electrical short circuit, earthing reduces the risk of electric shock providing an escape wire for the electric current.

The appliance is equipped with a mains lead which includes an earth wire for connecting to the earth terminal of your mains plug.

The plug must be plugged into a socket that is properly installed and earthed.

- * The wires in this mains lead are coloured in accordance with the following code:
 - Green and yellow : Earth
 - Blue : Neutral
 - Brown : Live
- AS the colours of the wires in the mains lead of this appliance may not correspond with the coloured markings indentifying the terminals in your plug, proceed as follows.
- Connect the green and yellow wire to the terminal in the plug marked with the letter E or the earth symbol (\perp) or coloured green or green-and-yellow.
- Connect the blue wire to the terminal marked with the letter N or coloured black.
- Connect the brown wire to the terminal marked with the letter L or coloured red.
- * Consult a qualified electrician or service technician if in doubt about any of these instructions.

The manufacturer of this washing machine will not accept any liability for damage to persons or material for non observance of these requirements.

There are no user serviceable parts inside the washing machine and if the mains lead of this appliance is damaged, it must only be replaced by qualified service personnel approved by the manufacturer because special tools are required.

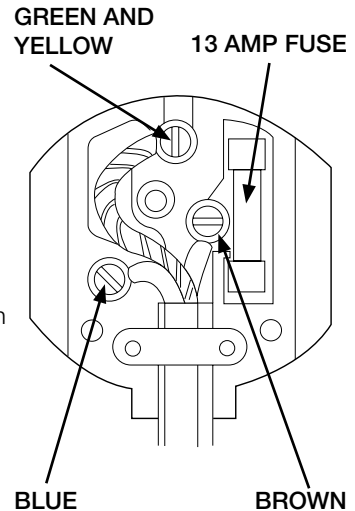

WARNING

Ensure that the plug and power cord are not damaged before use. If you have any reason to remove the moulded plug from this appliance, immediately remove the fuse and dispose of the plug. Do not connect the plug to a mains socket under any circumstances as there is a danger of electric shock.

CIRCUITS



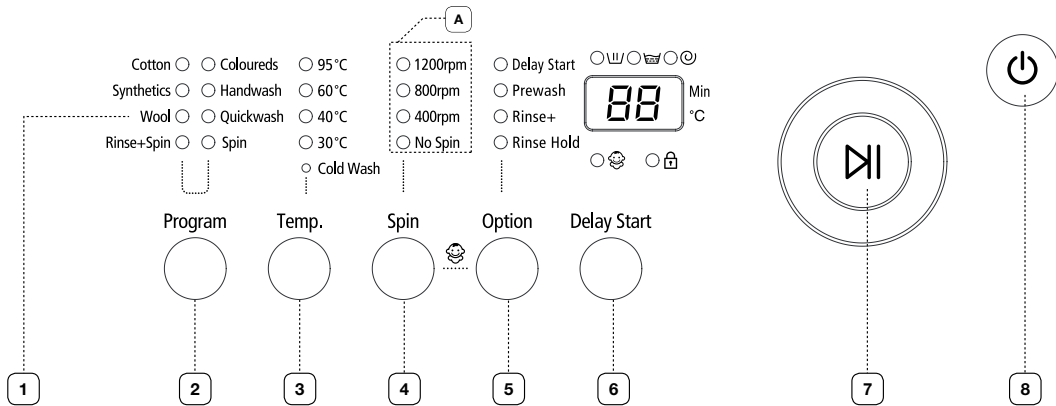

Your washing machine should be operated on a separate circuit from other appliances. Failure to do this may cause the circuit breaker to trip or the fuse to blow.

washing a load of laundry



OVERVIEW OF THE CONTROL PANEL



※ This is a general manual. The INLAY system may be different from that of the product you purchased. For **(A)**, see item 4 below to select the right specifications that match your product.

1 Display panel	Displays wash cycle and error messages. During execution of the program, the program indicator blinks.	
2 Program Select button	Press the button repeatedly to select one of the six available wash program. Cotton → Coloureds → Synthetics → Handwash → Wool → Quickwash → Rinse+Spin → Spin	
3 Temperature selection button	Press the button repeatedly to cycle through the available water temperature options (cold wash, 30°C, 40°C, 60°C and 95°C). When pressing this button during washing, you can see the selected temperature in the display panel.	
4 Spin selection button	WF-J1461/B1461	no spin () , 400, 800, 1400 rpm
	WF-J1261/B1261/R1261/F1261	no spin () , 400, 800, 1200 rpm
	WF-J1061/B1061/R1061/F1061/S1061	no spin () , 400, 800, 1000 rpm
	WF-J861/B861/R861/F861/S861	no spin () , 400, 800, 800+ rpm
5 Option button	Press the button repeatedly to cycle through the available partial wash options. Rinse Hold → Rinse+ → Rinse Hold+Rinse+ → Prewash → Prewash+Rinse Hold → Prewash+Rinse+ → Prewash+Rinse Hold+Rinse+  Prewash is only available when washing cotton, synthetic or Coloureds.	
6 Delay Start selection button	Press this button repeatedly to rotate between the retarded start options available. (from 3 Hours to 24 Hours, in 1 hour increments)	

washing a load of laundry

7  Start/Pause button	Press to pause and restart programs.
8  (On/Off) button	Press once to turn the washing machine on, press again to turn the washing machine off. If the washing machine power is left on for longer than 10 minutes without any buttons being touched, the power automatically turns off.

※ What is the “Child Lock” function?

- If you press the “Child Lock” button (Spin+Option button) longer than 2 sec during operation, this function is selected.
- If once this function is selected, no change can be done until the end of laundry.
- Press the “Child Lock” button (Spin+Option button) longer than 2 sec to cancel the function.



WM STOPS THE CURRENT STEP OF THE CYCLE OR DOES NOT PROCEED TO THE NEXT STEP OF WASHING (INDICATION OF REMAIN TIME ON LED DISPLAY MAY INCREASE).

Your new washing machine is equipped with Fuzzy Logic system, which not only sets the optimum level of water and other parameters of washing, but also controls the washing process as well as makes necessary corrections in order to provide better washing results. In the above- mentioned matter, the Fuzzy Logic system has detected deviations in washing cycle such as: high quantity of detergent at the end of the cycle, high vibration level while spinning, etc. You can adjust existing wash programs, i.e. change wash temperature and spin speed. After detection of such abnormalities, the washing machine is suspending the normal course of program in order to normalize these parameters and continue the cycle. Fuzzy logic system makes 7 attempts to eliminate such deviations. If it is impossible to normalize the above mentioned deviations by Fuzzy Logic system, you will see the corresponding indication on LED lamps. (see chapter “Troubleshooting”) The operation of Washing machine that corresponds to above- mentioned scheme is considered to be normal.



WASHING FOR THE FIRST TIME

Before washing clothes for the first time, you must run a complete cycle without clothes.

To do this:

1. Press the  (On/Off) button.
2. Pour a little detergent in the detergent drawer .
3. Turn on the water supply to the washing machine.
4. Press the Temperature button repeatedly until 40°C is displayed.
5. Press the **Start/Pause** button.
 - This will remove any water from the manufacturer’s test run remaining in the machine.

PUTTING DETERGENT IN THE WASHING MACHINE

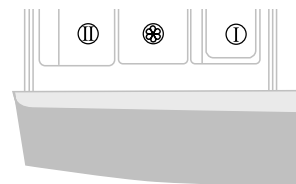

1. Pull out the detergent drawer.
2. Add laundry detergent into compartment .
3. Add softener into compartment  (if you desire).
4. Add prewash detergent into compartment  (if you desire).



WASHING CLOTHES MANUALLY

You can wash clothes manually without using the Fuzzy Logic feature.

To do so:

1. Turn on the water at the water source sink.
2. Press the  (On/Off) button on the washing machine.
3. Open the door.
4. Load the articles one at a time loosely into the drum, without overfilling.
5. Close the door.
6. Put the detergent in the detergent drawer .
7. Repeatedly press the Program button to select the cycle you prefer: Cotton, Coloureds, Synthetics, and Quickwash...
8. Press the Spin button to select the spin speed (No Spin, 400, 800,...,No Spin,...)
9. Repeatedly press the Option button to select the cycle you prefer (Prewash, Rinse+, Rinse hold, ...)
10. Press the Temperature button to select the temperature (cold water, 30°C, 40°C, 60°C, 95°C).
11. Press the Start/Pause button and the machine will begin the cycle.

When the cycle is finished:

1. Open the door.



The door will not open until 3 minutes after the machine stops or the power turns off.

2. Remove laundry.



The Slow rotation of drum is not fail of the machine after the last spin of Cotton, Coloureds or Quickwash course. That is a function to remove laundry easily.

SELECTING OPTIONS

Prewash

Prewash is only available when washing cotton, Coloureds, synthetics, delicate clothes.

To use prewash:

1. Load the prewash detergent into compartment of  the detergent drawer.
2. Select "Cotton", "Coloureds" or "Synthetic" with the Program select button.
3. Press the Option button until the "Prewash" indicator lights up on the control panel.
4. Press Start/Pause to begin the cycle.

Rinse+

Your machine will run through an additional rinsing cycle.

The washing duration will be prolonged accordingly.

Rinse Hold

The laundry remains soaking in the final rinse water.

Before the laundry can be unloaded, the "Spin" program must be run.

washing a load of laundry

WASHING TIPS AND HINTS

Sorting your laundry: Sort your laundry according to the following characteristics:

- **Type of fabric care label symbol:** Sort laundry into cottons, mixed fibers, synthetics, silks, wools and rayon.
- **Colour:** Divide whites and colours. Wash new, coloured items separately.
- **Size:** Placing items of different sizes in the same load will improve the washing action.
- **Sensitivity:** Wash delicate items separately, using the Wool wash program for pure new wool, curtains and silk articles. Check the labels on the items you are washing or refer to the fabric care chart in the appendix.

Emptying pockets: Coins, safety pins and similar items can damage linen, the washing machine drum, and the water tank.

Securing fasteners: Close zippers and fasten buttons or hooks; loose belts or ribbons should be tied together.

Determining load capacity: Do not overload the washing machine or your laundry may not wash properly. Use the chart below to determine the load capacity for the type of laundry you are washing.

Fabric Type	Load Capacity				
	WF-J1461/ J1261/ J1061/J861	WF-B1461/ B1261/ B1061/B861	WF-R1261/ R1061/R861	WF-F1261/ F1061/F861	WF-S1061/ S861
Cotton	7.0 kg	6.5 kg	5.2 kg	4.5 kg	3.5 kg
Coloureds	7.0 kg	6.5 kg	5.2 kg	4.5 kg	3.5 kg
Synthetics	3.0 kg	3.0 kg	2.5 kg	2.5 kg	2.0 kg
Wool	2.0 kg	2.0 kg	1.5 kg	1.5 kg	1.0 kg

Detergent tips: The type of detergent you should use is based on the type of fabric (Cotton, Synthetic, Wool items) colour, wash temperature, degree and type of soiling. Always use “low suds” laundry soap, which is designed for automatic washing machines.

When determining the detergent quantity, it's necessary to consider recommendations of the detergent manufacturer, indicated on the package, as well as weight, type of laundry, it's fouling factor and water hardness in your region.

 Keep detergents and additives in a safe, dry place out of the reach of children.

maintaining the washing machine

REPAIRING A FROZEN WASHING MACHINE

If the temperature drops below freezing and your washing machine is frozen:

1. Unplug the washing machine.
2. Pour warm water on the source faucet to loosen the water supply hose.
3. Remove the water supply hose and soak it in warm water.
4. Pour warm water into the washing machine drum and let it sit for 10 minutes.
5. Reconnect the water supply hose to the water faucet and check if the water supply and drain operations are normal.

CLEANING THE EXTERIOR

1. Wipe the washing machine surfaces, including the control panel, with a soft cloth and non-abrasive household detergents.
2. Use a soft cloth to dry the surfaces.
3. Do not pour water on the washing machine.

CLEANING THE DEBRIS FILTER

Clean the debris filter 2 or 3 times a year.

1. Remove the base cover from the front of the washing machine.
2. Unscrew the filter cap and take it out.
3. Wash any dirt or other material from the filter. Make sure the drain pump propeller behind the filter is not blocked. Replace the filter cap.
4. Replace the base cover.

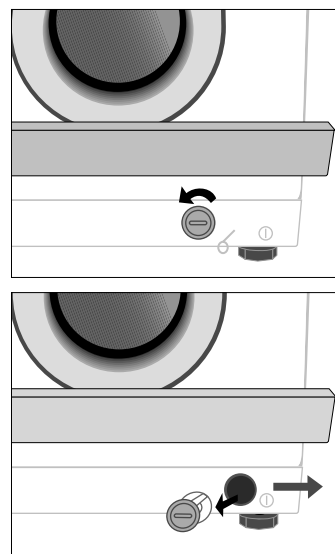

CLEANING THE WATER HOSE MESH FILTER

You should clean the water hose mesh filter at least one time per year, or when the lamps on your machine flickers:

To do this:

1. Turn off the water source to the washing machine.
2. Unscrew the hose from the back of the washing machine.
3. With a pair of pliers, gently pull out the mesh filter from the end of the hose and rinse it under water until clean. Also clean the inside and outside of the threaded connector.
4. Push the filter back into place.
5. Screw the hose back onto the washing machine.
6. Turn on the faucet and make sure the connections are watertight.

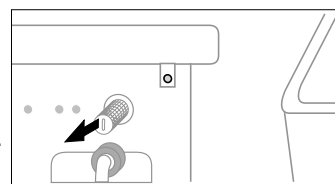

troubleshooting

PROBLEMS AND SOLUTIONS

PROBLEM	SOLUTION
The washing machine will not start	<ul style="list-style-type: none">• Make sure the door is firmly closed.• Make sure the washing machine is plugged in.• Make sure the water source faucet is turned on.• Make sure to press the Start/Pause button.
No water or insufficient water supply	<ul style="list-style-type: none">• Make sure the water source faucet is turned on.• Make sure the water source hose is not frozen.• Make sure the water intake hose is not bent.• Make sure the filter on the water intake hose is not clogged.
Detergent remains in the detergent drawer after the wash program is complete	<ul style="list-style-type: none">• Make sure the washing machine is running with sufficient water pressure.• Put the detergents in the inner parts of the detergent drawer (away from the outside edges).
Washing machine vibrates or is too noisy	<ul style="list-style-type: none">• Make sure the washing machine is set on a level surface. If the surface is not level, adjust the washing machine feet to level the appliance.• Make sure that the shipping bolts are removed.• Make sure the washing machine is not touching any other object.• Make sure the laundry load is balanced.
The washing machine does not drain and/or spin	<ul style="list-style-type: none">• Make sure the drain hose is not squashed or bent.• Make sure the water hose mesh filter is not clogged.

UNDERSTANDING ERROR MESSAGES

ERROR CODE	SOLUTION
dE	<ul style="list-style-type: none">• Close the door.
4E	<ul style="list-style-type: none">• Make sure the source water faucet is turned on.• Check the water pressure.
5E	<ul style="list-style-type: none">• Clean the debris filter.• Make sure the drainage hose is installed correctly.
UE	<ul style="list-style-type: none">• Laundry load is unbalanced; loosen any tangled laundry.• If only one item of clothing needs washing, such as a bathrobe or jeans, the final spin result might be unsatisfactory and an "UE" error message will be shown in the display window.
LE	<ul style="list-style-type: none">• Check the end of the drain hose is too low. (Make sure the holder of drain hose in the back is intact)• Check the end of the drain hose is submerged in water.

Before contacting After-Sales serv

1. Try to remedy the problem (See "Troubleshooting" on this page).
2. Restart the programme to see if the fault is repeated.
3. If the malfunction persists, call after-sales service and describe the problem.

programme chart

PROGRAMME CHART

(● user option)





























Program	Max load (kg)					Detergent And Additives			Temperature (MAX) °C	Spin speed (MAX) rpm				Delay start	Cycle Time (min)
	WF-J1461/J1261/J1061/J861	WF-B1461/B1261/B1061/B861	WF-R1261/R1061/R861	WF-F1261/F1061/F861	WF-S1061/S861	Pre-wash	Wash	Soft-ener		WF-J1461/B1461	WF-J1261/B1261/R1261/F1261	WF-J1061/B1061/R1061/F1061/S1061	WF-J861/B861/R861/F861/S861		
Cotton	7.0	6.5	5.2	4.5	3.5	●	yes	●	95	1400	1200	1000	800+	●	126
Coloureds	7.0	6.5	5.2	4.5	3.5	●	yes	●	60	1400	1200	1000	800+	●	98
Synthetics	3.0	3.0	2.5	2.5	2.0	●	yes	●	60	800	800	800	800	●	73
Wool	2.0	2.0	1.5	1.5	1.0		yes	●	40	400	400	400	400	●	42
Handwash	2.0	2.0	1.5	1.5	1.0		yes	●	40	400	400	400	400	●	37
Quickwash	3.0	3.0	2.0	2.0	1.5		yes	●	60	1400	1200	1000	800+	●	28

Program	Type of wash
Cotton	Averagely or lightly soiled cottons, bed linen, table linen, underwear, towels, shirts, etc.
Coloureds	Averagely or lightly soiled cottons, bed linen, table linen, underwear, towels, shirts, etc.
Synthetics	Lightly or averagely soiled blouses, shirts, etc. Made of polyester(Diolen, Trevira), polyamide(perlon, Nylon) or similar blends.
Handwash	Very light wash course like hand wash.
Wool	Only machine washable wollens with pure new wool label.
Quickwash	Lightly soiled cottons or linen blouses, shirts, dark coloured terry cloth, coloured linen articles, jeans, etc.

1. The programme duration data has been measured under the conditions specified in Standard IEC 456.
2. Consumption in individual homes may differ from the values given in the table due to variations in the pressure and temperature of the water supply, the load and the type of laundry.

appendix

FABRIC CARE CHART

 Resistant material	 Can be ironed at 100°C max
 Delicate fabric	 Do not iron
  Item may be washed at 95°C	 Can be dry cleaned using any solvent
  Item may be washed at 60°C	 Dry clean with perchloride, lighter fuel, pure alcohol or R113 only
  Item may be washed at 40°C.	 Dry clean with aviation fuel, pure alcohol or R113 only
  Item may be washed at 30°C.	 Do not dry clean
 Item may be hand washed	 Dry flat
 Dry clean only	 Can be hung to dry
 Can be bleached in cold water	 Dry on clothes hanger
 Do not bleach	 Tumble dry, normal heat
 Can be ironed at 200°C max	 Tumble dry, reduced heat
 Can be ironed at 150°C max	 Do not tumble dry

ELECTRICAL WARNINGS

To reduce the risk of fire, electrical shock, and other injuries, keep these safety precautions in mind:

- Operate the appliance only from the type of power source indicated on the marking label. If you are not sure of the type of power supplied to your home, consult your appliance dealer or local power company.
- Use only a grounded or polarized outlet. This plug will fit into the power outlet only one way. If you are unable to insert the plug fully into the outlet, try reversing the plug. If the plug still doesn't fit, contact your electrician to replace your outlet.
- Protect the power cord. Power supply cords should be routed so that they are unlikely to be walked on or pinched by items placed on or against them. Pay particular attention to cords at plugs, convenience receptacles, and the point where they exit from the unit.
- Do not overload the wall outlet or extension cords. Overloading can result in fire or electric shock.

PROTECTING THE ENVIRONMENT

- This appliance is manufactured from recyclable materials. If you decide to dispose of this appliance, please observe local waste disposal regulations. Cut off the power cord so that the appliance cannot be connected to a power source. Remove the door so that animals and small children cannot get trapped inside the appliance.
- Do not exceed the detergent quantities recommended in the detergent manufacturers' instructions.
- Use stain removal products and bleaches before the wash cycle only when strictly necessary.
- Save water and electricity by only washing full loads (the exact amount depends upon the program used).

DECLARATION OF CONFORMITY

This appliance complies with European safety standards, EC directive 93/68 and EN Standard 60335.

SPECIFICATION

WF-J1461/J1261/J1061/J861

WF-B1461/B1261/B1061/B861

TYPE		FRONT LOADING WASHER									
DIMENSION		WF-J1461/J1261/J1061/J861				WF-B1461/B1261/B1061/B861					
		W598mm x D600mm x H844mm				W598mm x D550mm x H844mm					
WATER PRESSURE		50 kPa ~ 800 kPa									
WATER VOLUME		68 ℓ				59 ℓ					
NET WEIGHT		WF-J1461/J1261		WF-J1061/J861		WF-B1461/B1261		WF-B1061/B861			
		74 kg		71 kg		71 kg		70 kg			
WASH AND SPIN CAPACITY		7 kg (DRY LAUNDRY)				6.5 kg (DRY LAUNDRY)					
POWER CONSUMPTION		MODEL		WF-J1461/J1261/J1061/J861				WF-B1461/B1261/B1061/B861			
		WASHING AND HEATING		220 V		2000 W		220 V		2000 W	
				240 V		2400 W		240 V		2400 W	
		SPIN	MODEL	WF-J1461	WF-J1261	WF-J1061	WF-J861	WF-B1461	WF-B1261	WF-B1061	WF-B861
			230 V	700 W	360 W	320 W	270 W	580 W	530 W	500 W	430 W
PUMPING		34 W									
PACKAGE Wt		MODEL		WF-J1461/J1261/J1061/J861				WF-B1461/B1261/B1061/B861			
		PAPER		2.5 kg				2.5 kg			
		PLASTIC		1.0 kg				1.0 kg			
SPIN REVOLUTION		MODEL		WF-J1461/B1461		WF-J1261/B1261		WF-J1061/B1061		WF-J861/B861	
		rpm		1400		1200		1000		800	

appendix

WF-R1261/R1061/R861

WF-F1261/F1061/F861

WF-S1061/S861

TYPE		FRONT LOADING WASHER								
DIMENSION	WF-R1261/R1061/R861		WF-F1261/F1061/F861			WF-S1061/S861				
	W598mm x D450mm x H844mm		W598mm x D404mm x H844mm			W598mm x D340mm x H844mm				
WATER PRESSURE		50 kPa ~ 800 kPa								
WATER VOLUME		49 ℓ		48 ℓ			43 ℓ			
NET WEIGHT	WF-R1261/R1061		WF-R861	WF-F1261/F1061/F861			WF-S1061/S861			
	65 kg		64 kg	61 kg			51 kg			
WASH AND SPIN CAPACITY		5.2 kg (DRY LAUNDRY)			4.5 kg (DRY LAUNDRY)			3.5 kg (DRY LAUNDRY)		
POWER CONSUMPTION	MODEL		WF-R1261/R1061/R861			WF-F1261/F1061/F861			WF-S1061/S861	
	WASHING AND HEATING		220 V	1900 W		220 V	1800 W		220 V	1800 W
			240 V	2200 W		240 V	2100 W		240 V	2100 W
	SPIN	MODEL	WF-R1261	WF-R1061	WF-R861	WF-F1261	WF-F1061	WF-F861	WF-S1061	WF-S861
		230 V	550 W	500 W	430 W	270 W	230 W	180 W	250 W	200 W
PUMPING		34 W								
PACKAGE Wt	MODEL		WF-R1261/R1061/R861			WF-F1261/F1061/F861			WF-S1061/S861	
	PAPER		2.1 kg			1.9 kg			1.8 kg	
	PLASTIC		0.9 kg			0.8 kg			0.8 kg	
SPIN REVOLUTION	MODEL		WF-R1261/F1261			WF-R1061/F1061/S1061			WF-R861/F861/S861	
	rpm		1200			1000			800	

memo



QUESTIONS OR COMMENTS?

Country	CALL	OR VISIT US ONLINE AT
AUSTRALIA	1300 362 603	www.samsung.com/au
CHINA	800-810-5858 , 010- 6475 1880	www.samsung.com.cn
HONG KONG	3698 - 4698	www.samsung.com/hk
INDIA	3030 8282 1800 110011	http://www.samsung.com/in/
INDONESIA	0800-112-8888	www.samsung.com/id
JAPAN	0120-327-527	www.samsung.com/jp
MALAYSIA	1800-88-9999	www.samsung.com/my
PHILIPPINES	1800-10-SAMSUNG (7267864)	www.samsung.com/ph
SINGAPORE	1800-SAMSUNG (7267864)	www.samsung.com/sg
THAILAND	1800-29-3232 02-689-3232	www.samsung.com/th
TAIWAN	0800-329-999	www.samsung.com/tw
VIETNAM	1 800 588 889	www.samsung.com/vn