



Washing Machine Owner's Instructions

P1493/SWP1493
P1293/SWP1293
P1093/SWP1093
P8093/SWP8093



Safety Precautions

Congratulations on your purchase of this Samsung washing machine. These Owner's Instructions contain valuable information on the installation, use, and care of this appliance. Please take the time to read these instructions so that you can take full advantage of the washing machine's features and enjoy this appliance for many years to come.

Before using the appliance

- Packing materials can be dangerous to children; keep all packing material (plastic bags, polystyrene, etc.) well out of the reach of children.
- The appliance is designed for home use only.
- Make sure that water and electrical connections are made by qualified technicians, observing the manufacturer's instructions (see "Installing the Washing Machine" on page 2) and local safety regulations.
- All packaging and shipping bolts must be removed before the appliance is used. Serious damage may occur if they are not removed. See "Removing the shipping bolts" on page 3.
- Before washing clothes for the first time, you must run a complete cycle without clothes. See "Washing for the first time" on page 7.

Safety instructions

- Before cleaning or carrying out maintenance, unplug the appliance from the electrical outlet or set the  (On/Off) button to Off.
- Make sure that the pockets of all clothing to be washed are empty. Hard, sharp objects, such as coins, safety pins, nails, screws, or stones can cause extensive damage to the appliance.
- Always unplug the appliance and turn off the water after use.
- Before you open the door of the appliance, check that the water has drained. Do not open the door if you can still see water.
- Pets and small children may climb into the appliance. Check the appliance before each use.
- The glass door becomes very hot during the washing cycle. Keep children away from the appliance while it is in use.
- Do not attempt to repair the appliance yourself. Repairs made by inexperienced or unqualified persons may cause injury and/or make more serious repairs to the appliance necessary.
- If the plug (power supply cord) is damaged, it must be replaced by the manufacturer or its service agent or a similar qualified person in order to avoid a hazard.
- This appliance should only be serviced by an authorized service center, and only genuine spare parts should be used.

Table of Contents

Safety Precautions-----	inside cover
Installing the Washing Machine -----	2
Unpacking the washing machine -----	2
Overview of the washing machine -----	2
Selecting a location -----	3
Adjusting the leveling feet -----	3
Removing the shipping bolts -----	3
Connecting the water supply hose -----	3
Positioning the drain hose -----	4
Plugging in the machine -----	5
Washing a Load of Laundry -----	6
Overview of the control panel -----	6
Washing for the first time -----	7
Putting detergent in the washing machine -----	7
Washing clothes using Fuzzy Logic -----	8
Setting prewash -----	9
Selecting options -----	9
Washing clothes manually -----	10
Using delay start -----	10
Washing tips and hints -----	11
Maintaining the Washing Machine -----	12
Draining the washing machine in an emergency -----	12
Repairing a frozen washing machine -----	12
Cleaning the exterior -----	12
Cleaning the detergent drawer and recess -----	12
Cleaning the debris filter -----	13
Cleaning the water hose mesh filter -----	13
Troubleshooting -----	14
Problems and solutions -----	14
Understanding error messages -----	14
Programme chart -----	15
Appendix -----	16
Fabric care chart -----	16
Electrical warnings -----	16
Protecting the environment -----	17
Declaration of conformity -----	17
Specification -----	17

Installing the Washing Machine

Unpacking the Washing Machine

Unpack your washing machine and inspect it for shipping damage. Also make sure that you have received all of the items shown below. If the washing machine was damaged during shipping or you do not have all of the items, contact your Samsung dealer immediately.

Overview of the washing machine

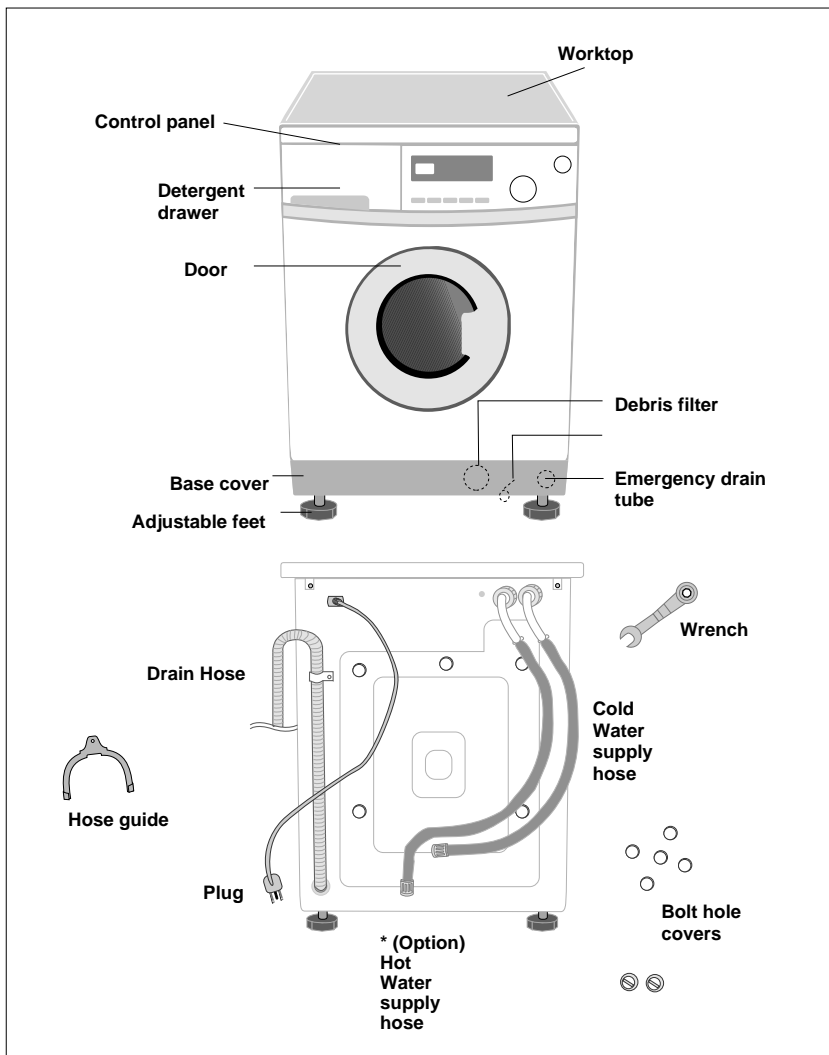

Installing the Washing Machine

Selecting a location

Before you install the washing machine, select a location with the following characteristics:

- A hard, level surface (if the surface is uneven, see "Adjusting the leveling feet," below)
- Away from direct sunlight.
- Adequate ventilation
- Room temperature that will not fall below 0 °C
- Away from sources of heat such as coal or gas

Make sure that the washing machine does not stand on its power cord.

Ventilation openings must not be obstructed by carpeting when the washing machine is installed on a carpeted floor.

Adjusting the leveling feet

If the floor is uneven, adjust the feet (do not insert pieces of wood or any other objects under the feet):

1. Loosen the leg bolt by turning it with your hand until it is at the desired height.
2. Tighten the locking nut by turning it with the supplied wrench.



Place the washer on a sturdy, flat surface.

If the washer is placed on an uneven or weak surface, noise or vibration occurs.

(Only a 1 degrees angle is allowed.)

Removing the shipping bolts

Before using the washing machine, you must remove the five shipping bolts from the back of the unit. To remove the bolts:

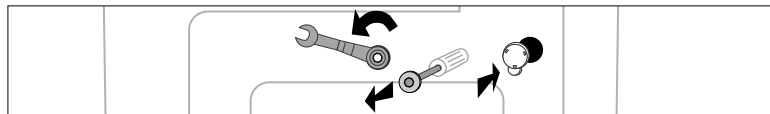

1. Loosen all bolts with the supplied wrench before removing them.
2. Take each bolt head and pull it through the wide part of the hole.
Repeat for each bolt.
3. Fill the holes with the supplied plastic covers.
4. Keep the shipping bolts for future use.

Connecting the water supply hose(Option)

1. Remove the adaptor from the water supply hose.



2. First, using a "+" type screw driver, loosen the four screws on the adaptor. Next, take the adaptor and turn part(b) following the arrow until there is a 5mm gap.



3. Connect adaptor to the water tap by tightening the screws firmly. Then, turn part (b) following the arrow and put(a) and (b) together.



4. Connect the water supply hose to the adaptor. Pull down part (c) of the water supply hose. When you release part (c) the hose automatically connects to the adaptor making a 'click' sound.



5. Connect the other end of the water supply hose to the inlet water valve at the top of the washer. Screw the hose clockwise all the way in.



• If the water tap has a screw type faucet, connect the water supply hose to the tap as shown.

NOTICE After completing connection, if water leaks from the hose, then repeat the same steps. Use the most conventional type of faucet for water supply. In case the faucet is square or too big, remove the spacing ring before inserting the faucet into the adaptor.

Installing the Washing Machine

Connecting the water supply hose

The water supply hose must be connected to the washing machine at one end and to the water faucet at the other. Do not stretch the water supply hose. If the hose is too short and you do not wish to move the water faucet, replace the hose with a longer, high pressure hose.

To connect the water supply hose:

1. Take the L-shaped arm fitting for the cold water supply hose and connect to the cold water supply intake on the back of the machine. Tighten by hand.

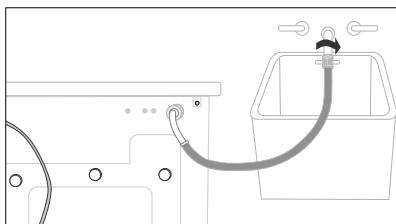

2. Connect the other end of the cold water supply hose to your sink's cold water faucet and tighten it by hand. If necessary, you can reposition the water supply hose at the washing machine end by loosening the fitting, rotating the hose, and retightening the fitting.

Option: 1. Take the red L-shaped arm fitting for the hot water supply hose and connect to the red hot water supply intake on the back of the machine. Tighten by hand.

2. Connect the other end of the hot water supply hose to your sink's hot water faucet and tighten it by hand.

3. Use a Y-piece if you only want to use cold water.

Note: The appliance is to be connected to the water mains using new hose-sets and that old hose-sets should not be used.

Positioning the drain hose

The end of the drain hose may be positioned in three ways:

Over the edge of a sink

The drain hose must be placed at a height of between 60 and 90 cm. To keep the drain hose spout bent, use the supplied plastic hose guide. Secure the guide to the wall with a hook or to the faucet with a piece of string to prevent the drain hose from moving.

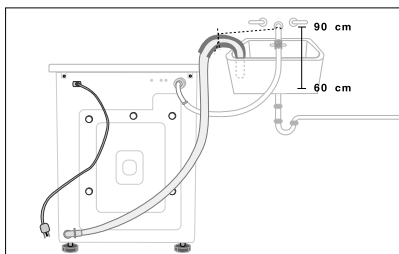

In a sink drain pipe branch

The drain pipe branch must be above the sink siphon so that the end of the hose is at least 60 cm above the ground.

In a drain pipe

Samsung recommends that you use a 65 cm high vertical pipe; it must be no shorter than 60 cm and no longer than 90 cm.

Installing the Washing Machine

Plugging in the machine

For European Users. You will **NOT** need to ground the plug of the washing machine.

For U.S. Users. You **MUST** ground the plug of the washing machine.

Check with a licensed electrician before using the machine to make sure it is properly grounded.

For U.K. Users.

Wiring Instructions

WARNING THIS APPLIANCE MUST BE EARTHED.

This appliance must be earthed. In the event of an electrical short circuit, earthing reduces the risk of electric shock providing an escape wire for the electric current. The appliance is equipped with a mains lead which includes an earth wire for connecting to the earth terminal of your mains plug.

The plug must be plugged into a socket that is properly installed and earthed.

*The wires in this mains lead are coloured in accordance with the following code:

- | | |
|--------------------|-----------|
| • Green and yellow | : Earth |
| • Blue | : Neutral |
| • Brown | : Live |
- AS the colours of the wires in the mains lead of this appliance may not correspond with the coloured markings indentifying the terminals in your plug, proceed as follows.
 - Connect the green and yellow wire to the terminal in the plug marked with the letter E or the earth symbol (\perp) or coloured green or green-and-yellow.
 - Connect the blue wire to the terminal marked with the letter N or coloured black.
 - Connect the brown wire to the terminal marked with the letter L or coloured red.
- * Consult a qualified electrician or service technician if in doubt about any of these instructions. The manufacturer of this washing machine will not accept any liability for damage to persons or material for non observance of these requirements. There are no user serviceable parts inside the washing machine and if the mains lead of this appliance is damaged, it must only be replaced by qualified service personnel approved by the manufacturer because special tools are required.

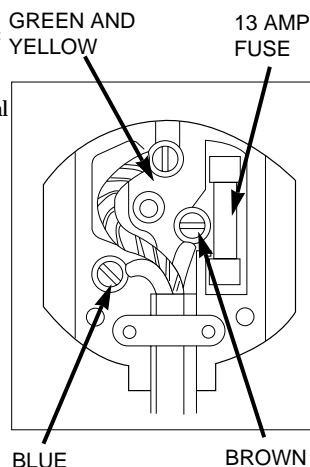

WARNING

Ensure that the plug and power cord are not damaged before use. If you have any reason to remove the moulded plug from this appliance, immediately remove the fuse and dispose of the plug. Do not connect the plug to a mains socket under any circumstances as there is a danger of electric shock.

CIRCUITS

Your washing machine should be operated on a separate circuit from other appliances. Failure to do this may cause the circuit breaker to trip or the fuse to blow.

Washing a Load of Laundry

Overview of the control panel

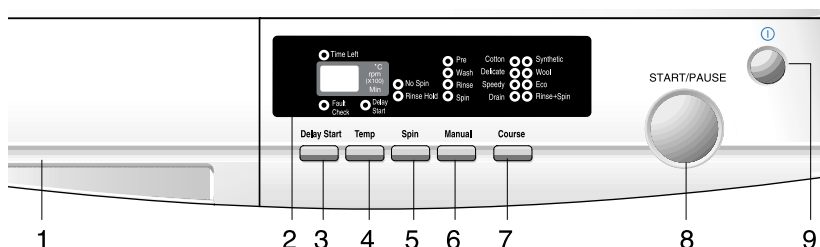

1. Detergent dispenser
2. Display panel
Displays the remaining wash cycle time and error messages.
3. Delay Start button
Press the button repeatedly to cycle through the available delayed start options (from 1 hour to 24 hours in one hour increments).
4. Temperature selection button
Press the button repeatedly to cycle through the available water temperature options (cold water, 30 °C, 40 °C, 60 °C and 95 °C).
When pressing this button during washing, you can see the selected temperature in the display panel.

5. Spin Speed button

Press the button repeatedly to cycle through the available spin speed options.

P1493/SWP1493	no, rh, 400, 600, 800, 1000, 1200, 1400 rpm	<i>no: no spin,</i>
P1293/SWP1293	no, rh, 400, 600, 800, 1000, 1200 rpm	<i>rh: rhine hold</i>
P1093/SWP1093	no, rh, 400, 600, 800, 1000 rpm	
P8093/SWP8093	no, rh, 400, 600, 800 rpm	

When pressing this button during operation, you can see the selected spin speed in the display panel.

6. Manual button

Press the button repeatedly to cycle through the available partial wash options {Wash+Rinse+Spin → Prewash+Wash+ Rinse+Spin → Spin → Rinse(1 time)+Spin → Rinse(2 times)+Spin → Rinse(3 times)+Spin}.

Note : Prewash is only available when washing cotton, synthetic or delicate.

7. Course button

Press the button to select one of the eight available wash programs.

Cotton, Synthetic, Delicate, Wool, Speedy, Eco, Drain, Rinse+Spin

8. Start/Pause button

Press to pause and restart programs.

9. Ⓞ (On/Off) button

Press once to turn the washing machine on, press again to turn the washing machine off. If the washing machine power is left on for longer than 10 minutes without any buttons being touched, the power automatically turns off.

Washing a Load of Laundry

Washing for the first time

Before washing clothes for the first time, you must run a complete cycle without clothes. To do this:

1. Press the ① (On/Off) button.
2. Pour a little detergent into compartment ② in the detergent drawer.

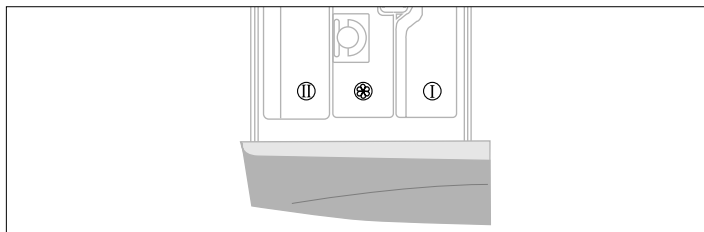

3. Turn on the water supply to the washing machine.
 4. Press the Temperature button repeatedly until 40 °C is displayed.
 5. Press the Start/Pause button.
- This will remove any water from the manufacturer's test run remaining in the machine.

Putting detergent in the washing machine

1. Pull out the detergent drawer.
2. Add laundry detergent into compartment ②.
3. Add softener into compartment ③ (if you desire).
4. Add prewash detergent into compartment ① (if you desire).

*Option

Using Hot/Water

- The hot water valve is operated when you select a water temperature option above 60 °C (60 °C or 95 °C).

Washing a Load of Laundry

Washing clothes using Fuzzy Logic

Your new washing machine makes washing clothes easy, using Samsung's "Fuzzy Logic" automatic control system. When you select a wash program, the machine will set the correct temperature, washing time, and washing speed.

To wash clothes using the Fuzzy Logic programs:

1. Turn on your sink's water faucet.
2. Open the door.
3. Load the articles one at a time loosely into the drum, without overfilling.
4. Press the **⓪** (On/Off) button.
5. Close the door.
6. Add the detergent, softener, and prewash detergent (if necessary) into the appropriate compartment.

Note: Prewash is only available when washing cotton, synthetic and delicate garments. It is only necessary if your clothing is heavily soiled. If you wish to use prewash, please see "Setting prewash" on page 9.

7. Press the program button to select the appropriate program for the type of clothes you are washing: Synthetic, Delicate, Wool, Speedy, Eco, Drain, Rinse+Spin.

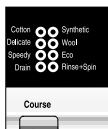

You will see the indicators light up on the control panel.

8. At this time, you can control the wash temperature, spin speed and delay time by pressing the appropriate option button.
9. Press the Start/Pause button and the wash cycle will begin.
The time delay indicator will light up and the remaining time for the cycle will appear in the display.

When the cycle is finished:

Ten minutes after the total cycle has finished, the power will turn off automatically.

1. Open the door.
Note: The door will not open until 3 minutes after the machine stops or the power turns off.
2. Remove laundry.

Washing a Load of Laundry

Setting prewash

Prewash is only available when washing cotton, synthetic or delicate clothes.

To use prewash:

1. Load the prewash detergent into compartment ① of the detergent drawer.
2. Select the wash program (Cotton, Synthetic or Delicate).
3. Press the Option button until the "Prewash" indicator lights up on the control panel.
4. Press Start/Pause to begin the cycle.

Selecting options

No spin

The laundry remains in the drum without being spun after the final drain.

Rinse Hold

The laundry remains soaking in the final rinse water.

Before the laundry can be unloaded, the "Spin" program must be run.

Washing a Load of Laundry

Washing clothes manually

You can wash clothes manually without using the Fuzzy Logic feature. To do so:

1. Turn on the water at the water source sink.
2. Open the door.
3. Load the articles one at a time loosely into the drum, without overfilling.
4. Press the \odot (On/Off) button on the washing machine.
5. Close the door.
6. Put the detergent and, if necessary, softener or prewash detergent, in the appropriate compartments.
7. Press the Temperature button to select the temperature (cold water, 30°C, 40°C, 60°C, 95°C).
8. Press the Spin button to select the spin speed, [no, rh, 400, 600, 800, ..., no, ... revolutions per minute(rpm)].

Note: The rinse hold program allows you to take clothes that are dripping wet out of the washing machine.

no : No Spin, rh : Rinse Hold.

9. Repeatedly press the Option button to select the cycle you prefer: Prewash (for Cotton, Synthetic, Delicate only)
10. Press the Start/Pause button and the machine will begin the cycle.

When the cycle is finished:

1. Open the door.
Note: The door will not open until 3 minutes after the machine stops or the power turns off.
2. Remove laundry.

Using Delay Start

You can set the washing machine to start your wash automatically at a later time, choosing from a 1 to a 24 hour delay (in 1 hour increments).

To do this:

1. Manually or automatically set your washing machine for the type of clothes you are washing.
2. Press the Delay Start button repeatedly until the delay time is set.
3. Press the Start/Pause button. The Delay Start indicator will light, and the clock will begin counting down until it reaches your start time.
4. To cancel Delay Start, press the \odot (On/Off) button, then turn the washing machine on again.

Washing a Load of Laundry

Washing tips and hints

Sorting your laundry : Sort your laundry according to the following characteristics:

- **Type of fabric care label symbol** : Sort laundry into cottons, mixed fibers, synthetics, silks, wools and rayon.
- **Colour** : Divide whites and colours. Wash new, coloured items separately.
- **Size**: Placing items of different sizes in the same load will improve the washing action.
- **Sensitivity**: Wash delicate items separately, using the Delicate wash program for pure new wool, curtains and silk articles. Check the labels on the items you are washing or refer to the fabric care chart in the appendix.

Emptying pockets : Coins, safety pins and similar items can damage linen, the washing machine drum, and the water tank.

Securing fasteners : Close zippers and fasten buttons or hooks; loose belts or ribbons should be tied together.

Prewashing cotton : Your new washing machine, combined with modern detergents, will give perfect washing results, thus saving energy, time, water and detergent. However, if your cotton is particularly dirty, use a prewash with a protein-based detergent.

Determining load capacity: Do not overload the washing machine or your laundry may not wash properly. Use the chart below to determine the load capacity for the type of laundry you are washing.

Fabric Type	Load Capacity
Coloured/cotton	
-average/lightly soiled	5.0 kg
-heavily soiled	5.0 kg
Synthetics	2.5 kg
Delicates	2.0 kg
Wools	1.5 kg

Detergent tips: The type of detergent you should use is based on the type of fabric (cotton, synthetic, delicate items, wool), colour, wash temperature, degree and type of soiling. Always use "low suds" laundry soap, which is designed for automatic washing machines.

Follow the detergent manufacturer's recommendations based upon the weight of the laundry, the degree of soiling, and the hardness of the water in your area. If you do not know how hard your water is, ask your water authority.

Note:

Keep detergents and additives in a safe, dry place out of the reach of children.

Maintaining the Washing Machine

Draining the washing machine in an emergency

1. Unplug the washing machine from the power supply.
2. Remove the base cover by using a screw driver to pry it off.
3. Unscrew the emergency drain cap by turning left. Grip the cap on the end of the emergency drain tube and slowly pull it out about 20 cm.
4. Allow all the water to flow into a bowl.
5. Reinsert the drain tube and screw the cap back on.
6. Replace the base cover.

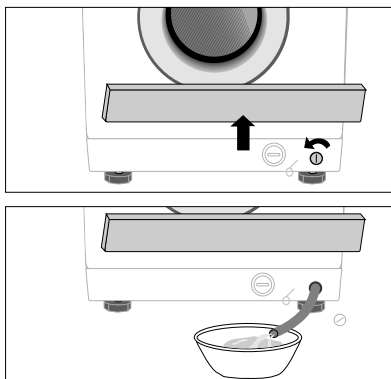

Repairing a frozen washing machine

If the temperature drops below freezing and your washing machine is frozen:

1. Unplug the washing machine.
2. Pour warm water on the source faucet to loosen the water supply hose.
3. Remove the water supply hose and soak it in warm water.
4. Pour warm water into the washing machine drum and let it sit for 10 minutes.
5. Reconnect the water supply hose to the water faucet and check if the water supply and drain operations are normal.

Cleaning the exterior

1. Wipe the washing machine surfaces, including the control panel, with a soft cloth and non-abrasive household detergents.
2. Use a soft cloth to dry the surfaces.
3. Do not pour water on the washing machine.

Cleaning the detergent drawer and recess

1. Press the release lever on the inside of the detergent drawer and pull it out.
2. Remove the cap from compartment ②.
3. Wash all of the parts under running water.
4. Clean the drawer recess with an old toothbrush.
5. Reinsert the cap (pushing it firmly into place) and replace the liquid detergent divider into the drawer.
6. Push the drawer back into place.
7. Run a rinse program without any laundry in the drum.

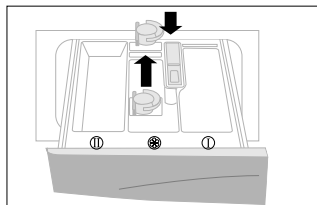

Maintaining the Washing Machine

Cleaning the debris filter

Clean the debris filter 2 or 3 times a year.

1. Remove the base cover from the front of the washing machine.
2. Unscrew emergency drain cap by turning left and drain off all the water. See "Draining the washing machine in an emergency" on page 12.
3. Unscrew the filter cap and take it out.

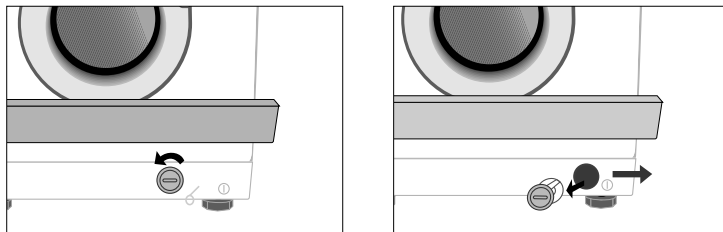

4. Wash any dirt or other material from the filter. Make sure the drain pump propeller behind the filter is not blocked. Replace the filter cap.
5. Replace the base cover.

Cleaning the water hose mesh filter

You should clean the water hose mesh filter at least one time per year, or when you see the following error message on the display:



To do this:

1. Turn off the water source to the washing machine.
2. Unscrew the hose from the back of the washing machine.
3. With a pair of pliers, gently pull out the mesh filter from the end of the hose and rinse it under water until clean. Also clean the inside and outside of the threaded connector.



4. Push the filter back into place.
5. Screw the hose back onto the washing machine.
6. Turn on the faucet and make sure the connections are watertight.

Troubleshooting

Problems and solutions

The washing machine will not start

- Make sure the door is firmly closed.
- Make sure the washing machine is plugged in.
- Make sure the water source faucet is turned on.
- Make sure to press the Start/Pause button.

No water or insufficient water supply

- Make sure the water source faucet is turned on.
- Make sure the water source hose is not frozen.
- Make sure the water intake hose is not bent.
- Make sure the filter on the water intake hose is not clogged.

Detergent remains in the detergent drawer after the wash program is complete

- Make sure the washing machine is running with sufficient water pressure.
- Put the detergents in the inner parts of the detergent drawer (away from the outside edges).

Washing machine vibrates or is too noisy

- Make sure the washing machine is set on a level surface. If the surface is not level, adjust the washing machine feet to level the appliance (see page 3).
- Make sure that the shipping bolts are removed (see page 3).
- Make sure the washing machine is not touching any other object.
- Make sure the laundry load is balanced.

The washing machine does not drain and/or spin

- Make sure the drain hose is not squashed or bent.
- Make sure the water hose mesh filter is not clogged (see page 13).

Understanding error messages

Error displayed

Solution



Close the door.



- Make sure the source water faucet is turned on.
- Check the water pressure.



- Clean the debris filter.
- Make sure the drainage hose is installed correctly.



Laundry load is unbalanced; loosen any tangled laundry.

If only one item of clothing needs washing, such as a bathrobe or jeans, the final spin result might be unsatisfactory and an "E4" error message will be shown in the display window.



- Check the end of the drain hose is too low.
(Make sure the holder of drain hose in the back is intact)
- Check the end of the drain hose is submerged in water.

Before contacting After-Sales service:

1. Try to remedy the problem (See "Troubleshooting" on this page).
2. Restart the programme to see if the fault is repeated.
3. If the malfunction persists, call after-sales service and describe the problem.

Programme Chart

























PRO-GRAM	Max load (kg)	DETERGENT AND ADDITIVES			Temperature (MAX) °C	Spin Speed(MAX)rpm				Delay start	Function Pre wash	Water (l)	Electricity (kWh)
		Pre wash	wash	Sof tener		P1493/SWP1493	P1293/SWP1293	P1093/SWP1093	P8093/SWP8093				
Cotton	5.0	*	yes	*	95	1400	1200	1000	800	*	*	54	1.82
Synthetic	2.5	*	yes	*	60	800	800	800	800	*	*	54	0.72
Delicate	2.0	*	yes	*	40	600	600	600	600	*	*	53	0.49
Wool	1.5	-	yes	*	40	400	400	400	400	*	-	59	0.52
Speedy	2.0	-	yes	*	40	1000	1000	1000	800	*	-	38	0.57
Eco	1.5	-	yes	*	30	800	800	800	800	*	-	41	0.31

PROGRAM	Type of WASH
Cotton	Averagely or lightly soiled cottons, bed linen, table linen, underwear, towels, shirts, etc.
Synthetic	Lightly or averagely soiled blouses, shirts, etc. Made of polyester(Diolen, Trevira), polyamide(perlon, Nylon) or similar blends.
Delicate	Delicate curtains, dresses, skirts, shirts and blouses.
Wool	Only machine washable wollens with pure new wool label.
Speedy	Lightly soiled cottons or linen blouses, shirts, dark coloured terry cloth, coloured linen articles, jeans, etc.
Eco	Lightly soiled cottons or linen blouses, shirts, dark coloured terry cloth, coloured linen articles, jeans, etc.

1. Programme with prewash lasts approx. 15 minutes longer.
2. The programme duration data has been measured under the conditions specified in Standard IEC 456.
3. Consumption in individual homes may differ from the values given in the table due to variations in the pressure and temperature of the water supply, the load and the type of laundry.

Appendix

Fabric care chart

	Resistant material		Can be ironed at 100 °C max
	Delicate fabric		Do not iron
	Item may be washed at 95 °C		Can be dry cleaned using any solvent
	Item may be washed at 60 °C		Dry clean with perchloride, lighter fuel, pure alcohol or R113 only
	Item may be washed at 40 °C		Dry clean with aviation fuel, pure alcohol or R113 only
	Item may be washed at 30 °C		Do not dry clean
	Item may be hand washed		Dry flat
	Dry clean only		Can be hung to dry
	Can be bleached in cold water		Dry on clothes hanger
	Do not bleach		Tumble dry, normal heat
	Can be ironed at 200 °C max		Tumble dry, reduced heat
	Can be ironed at 150 °C max		Do not tumble dry

Electrical warnings

To reduce the risk of fire, electrical shock, and other injuries, keep these safety precautions in mind:

- Operate the appliance only from the type of power source indicated on the marking label. If you are not sure of the type of power supplied to your home, consult your appliance dealer or local power company.
- Use only a grounded or polarized outlet. For your safety, this appliance is equipped with a polarized alternating current line plug having one blade wider than the other. This plug will fit into the power outlet only one way. If you are unable to insert the plug fully into the outlet, try reversing the plug. If the plug still doesn't fit, contact your electrician to replace your outlet.
- Protect the power cord. Power supply cords should be routed so that they are unlikely to be walked on or pinched by items placed on or against them. Pay particular attention to cords at plugs, convenience receptacles, and the point where they exit from the unit.
- Do not overload the wall outlet or extension cords. Overloading can result in fire or electric shock.

Protecting the environment

- This appliance is manufactured from recyclable materials. If you decide to dispose of this appliance, please observe local waste disposal regulations. Cut off the power cord so that the appliance cannot be connected to a power source. Remove the door so that animals and small children cannot get trapped inside the appliance.
- Do not exceed the detergent quantities recommended in the detergent manufacturers' instructions.
- Use stain removal products and bleaches before the wash cycle only when strictly necessary.
- Save water and electricity by only washing full loads (the exact amount depends upon the program used).

Declaration of conformity

This appliance complies with European safety standards, EC directive 93/68 and EN Standard 60335.

Specification

TYPE	FRONT LOADING WASHER						
DIMENSION	W598mm × D550mm × H844mm						
WATER PRESSURE	50 kPa ~ 800 kPa						
WEIGHT	75 kg						
WASH and SPIN CAPACITY	5.0 kg (DRY LAUNDRY)						
POWER CONSUMPTION	WASHING		220V		180W		
			240V		180W		
	WASHING AND HEATING		220V		2000W		
			240V		2400W		
	SPIN	MODEL	P1493/ SWP1493	P1293/ SWP1293	P1093/ SWP1093	P8093/ SWP8093	
			220V	550W	550W	500W	430W
PUMPING		34W					
WATER VOLUME	54 l (STANDARD COURSE)						
SPIN REVOLUTION	MODEL	P1493/ SWP1493	P1293/ SWP1293	P1093/ SWP1093	P8093/ SWP8093		
	rpm	1400	1200	1000	800		
PACKAGE Wt	PAPER	2.6 kg					
	PLASTIC	0.9 kg					

*IN CASE THE NEED FOR
SERVICING ARISES*

-Don't hesitate to call any AS center nearby with your name, address and telephone number when anything wrong with your product occurs.



Code No.: DC68-01324A-DW
(English)