



OUR IDEAS. YOUR HOME.

Instructions for Installation and Use

6kg Washing Machine
Aquarius

To the Installer:

Before installation, fill in the product details on the back cover of this book. The information can be found on the rating plate.

To the User:

You must read these instructions prior to installing and using the appliance and then retain them for future reference.

Description

GB



• Please record the Model number and Serial number of your machine on the back cover of this book for future reference.
- The Serial number can be found on the inside door trim.

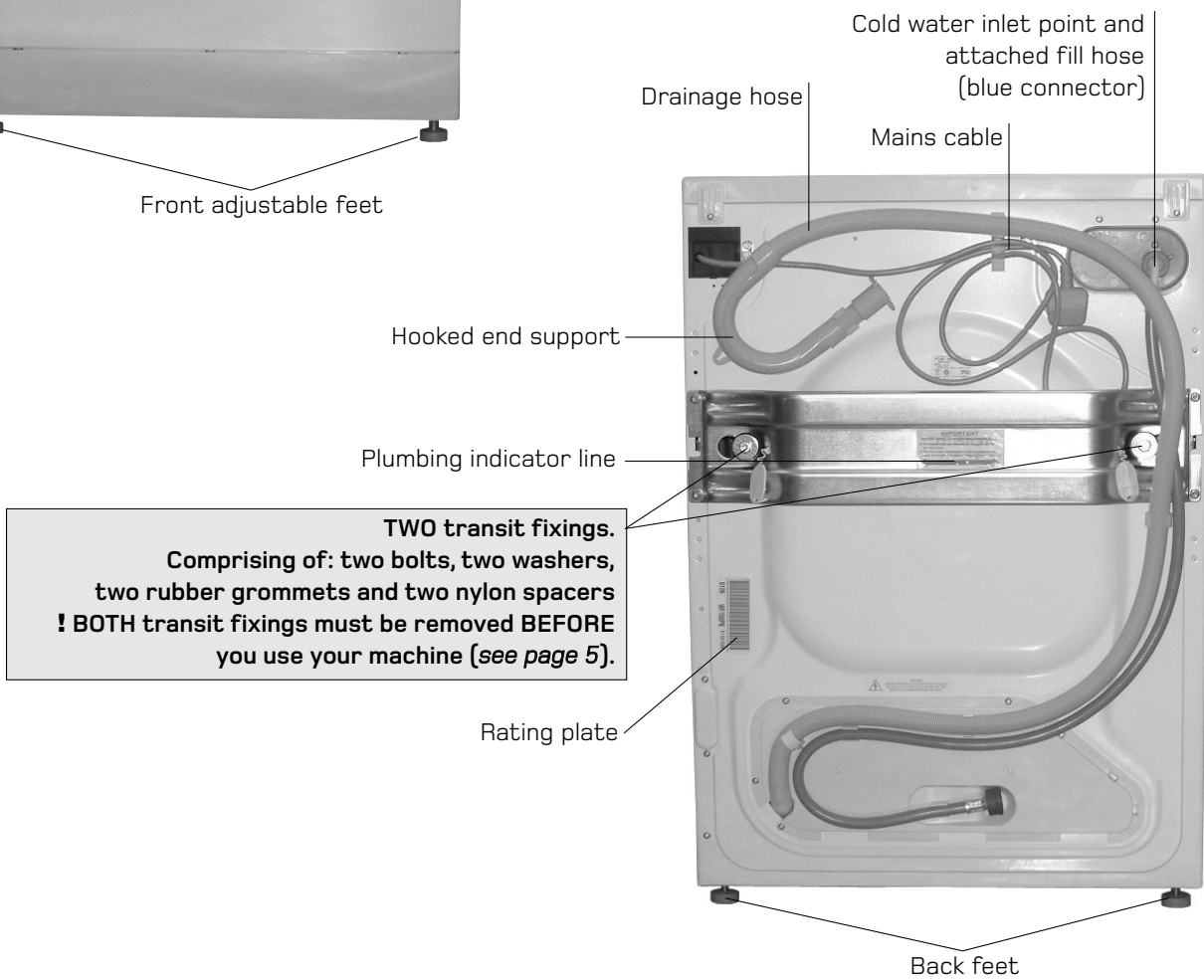

TWO transit fixings.
Comprising of: two bolts, two washers, two rubber grommets and two nylon spacers
! BOTH transit fixings must be removed BEFORE you use your machine (see page 5).

GB	
Description, 2	Description
Installation, 4-7 Unpacking Remove the transit fixings Location Levelling Water connection Drainage connection Electrical connection Before you start using your machine	Contents
Control Panel Features, 8 Aquarius	Installation
Programmes and Option Modifiers, 9-13 Starting a programme Programme table Wash labels and tips Option modifiers and special features	Control Panel Features
Detergents, 14 Detergent dispenser	Programmes and Option Modifiers
Care and Maintenance, 15 Cleaning your machine Fuses Changing the plug Cleaning the pump	Detergents and Laundry
Precautions and Advice, 16-17 General safety Saving energy and respecting the environment Disposal	Care and Maintenance
Something Wrong? - Troubleshooting, 18-19	Precautions and Advice
Service, 20 Before calling for assistance Spare parts Key Contacts	Something Wrong? - Troubleshooting
	Service

! Keep this instruction book on hand in order to refer to it when necessary. Take it with you when you move, and should you sell this appliance or pass it on to another party, make sure that this booklet is supplied along with the appliance so that the new owner may be informed about warnings and suggestions on how the machine works.



Installation

GB

! Read these instructions carefully: the following pages contain important information on installation and suggestions on how the appliance works.

Unpacking

1. Using scissors, cut carefully along one corner post to remove the film.

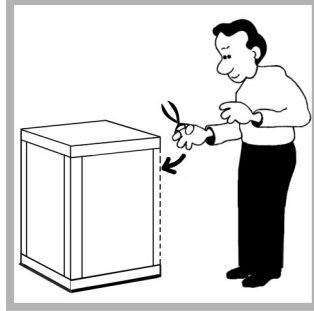

2. Lift off the polystyrene top cap and remove the four corner posts.

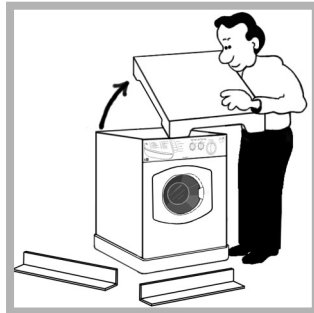

3. Carefully lay the left side of the machine down onto the top cap.

! We recommend that a second person helps to raise and lower the machine.



4. Remove the polystyrene base.

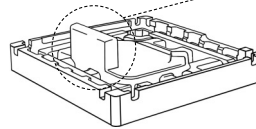
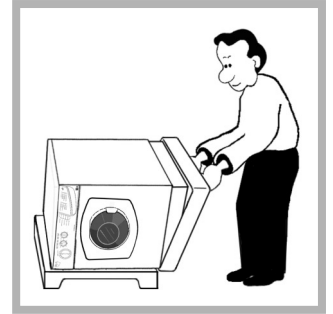

! **IMPORTANT check** when unpacking your machine:

! This is a part of the polystyrene base and should have stayed intact when you removed the base.

! If it has broken off and is still in the machine... **remove it...** while the machine is still laying on its side on the top cap.

5. Stand the machine upright.

! We recommend that a second person helps to raise and lower the machine.

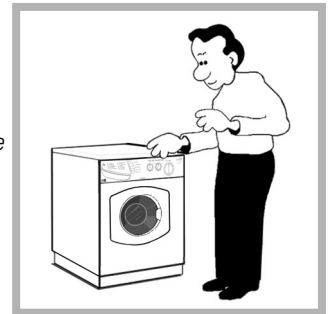

! Continue to read the rest of these instructions carefully; the following pages contain important information on installation and troubleshooting.



! Protect the environment - please dispose of the packaging material carefully and considerately.

Installation

Remove the transit fixings

IMPORTANT: Follow these instructions to remove the TWO transit fixings (see *Description* for location).

! Situated one either side of the rear panel, **BOTH transit bolts MUST be removed before use.**



! Failure to do so may cause damage to your machine.

! It is important the TWO transit fixings come out intact.

! Be sure to remove **TWO bolts, TWO washers, TWO rubber grommets and TWO nylon spacers** (see pic).



1. Unscrew the bolt using a 13mm spanner.

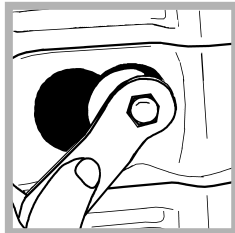

2. STOP when 3 threads can be seen.

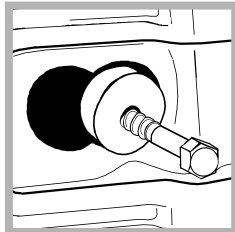

3. Hold, slide sideways and pull to remove.

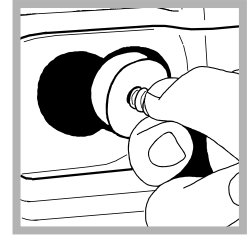

4. For safety, insert one of the the plastic covers (supplied with your machine) over the hole.

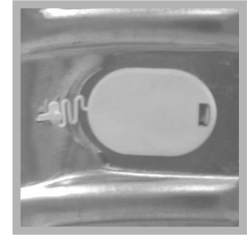

! Repeat steps 1 to 4 to remove the second transit bolt.

! Packaging materials are not children's toys.

Location

Where you install your machine will affect its performance:

! For your safety and to comply with electrical regulations, seek professional advice if you want to install your machine in a bath or shower room.

- Make sure that the electrical socket and water taps are easily accessible. **You should switch off the machine's electrical and water supplies when you are not using it for extended periods.**
- Make sure that you allow enough space for the machine. Select a space at least 60cm wide, 60cm deep and 85cm high. Also leave enough space to open the door fully, so that you can load and unload it easily.
- Where possible, the machine should be positioned on a solid floor to minimise vibration.

! Take care when you move the machine not to rip any floor coverings. The weight of the machine may cause indentations in some floor coverings.

Did you know?...

- ...the transit fixings are fitted to ensure that your machine is undamaged during delivery.
- ...both of the transit fixings **MUST BE removed** before using the machine, be sure to remove **TWO bolts, TWO washers, TWO rubber grommets and TWO nylon spacers**, not doing so will lead to excessive vibration, movement of the machine and could eventually lead to internal damage.
- ...the majority of problems with noisy machines are due to the transit fixings not being removed.
- ...you will be charged for a service engineers visit if a problem with your machine is caused by incorrect installation or misuse.

GB

Description

Contents

Installation

Control Panel Features

Programmes and Option Modifiers

Detergents and Laundry

Care and Maintenance

Precautions and Advice

Something Wrong? - Troubleshooting

Service

Installation

GB

Levelling

Your machine will be noisy if the two front feet are not adjusted so that the machine stands firm and level.

! The machine must be levelled from side to side and from front to back.

1. Move your machine into its final location, taking care not to trap or kink the hoses.
2. Turn one or both front feet anti-clockwise by hand until the feet cannot be turned any more. When adjusting the feet, use a spirit level to check the machine stands level, from side to side and from front to back. The spring on each foot will stop them coming loose.

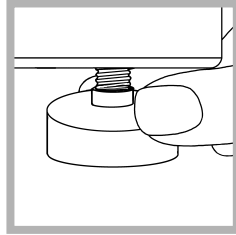

! If it is placed on a fitted or loose carpet, adjust the feet in such a way as to allow enough room for ventilation beneath the machine.

Water Connection

Remember this is a cold fill machine.

! Please use the new hose supplied, fitted to the machine. Old hoses may cause leaks due to worn out washers or may be split due to water pressure.

! Before making connections to the cold water supply, allow the water to run freely from the supply tap until it is perfectly clear.

Connecting the cold water inlet hose to the COLD WATER SUPPLY:

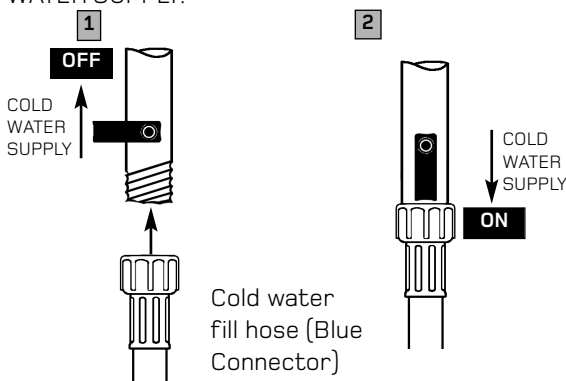

Did you know?...

- ...the most common cause of problems with water connection is that the customer has not turned the supply tap on..
- ...it is very important to ensure that your hoses or cables are not kinked or squashed when the machine is pushed back into its location, as this can lead to your machine failing to fill or empty the water.
- ...the majority of problems with noisy machines are due to the feet not being adjusted correctly to level the machine.

1. Screw the cold water fill hose (blue connector) onto the cold water supply until tight.
2. Turn on the cold water supply and check for leaks, tighten if necessary.

! We recommend fitting a 3/4" sealing cap to the hot water supply tap (if present), to ensure there are no leaks. Sealing caps can be purchased from Hotpoint Service on 08709 077 077 or all good DIY and Plumbing outlets.

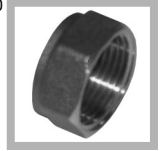

Benefits of cold fill

- Modern detergents are designed to give the best cleaning results at low temperatures. Biological detergents contain enzymes which are active between 30°C and 53°C, giving greater results at lower temperatures.
- Cold water relaxes fabrics, whilst hot water can seal in stains.
- Improved stain removal with cold water.
- The most commonly used programme at present is 40°C, which will take on cold water even if hot and cold were available.
- You can heat the water required to finish the wash cycle, which makes it more economical than taking water heated in a tank by an immersion heater or gas boiler.

Hints and tips

- ! Make sure there are no kinks or bends in the hose.**
- ! The water pressure at the supply tap must be within the values indicated in the Technical Details table (see page 17).**
- ! If the water inlet hose is not long enough, you can purchase an extended hose from Hotpoint Service on 08709 077 077.**
- ! Always use a new inlet hose.**
- ! Check the water inlet hose at least once a year, replace if cracked as worn hoses could split under water pressure.**

! Turn on the water supply and check that the connections do not leak. If there is a leak, turn off the water supply, disconnect the hoses and check that the sealing washers are in place. Refit the hoses and turn on the water supply.

Drainage Connection

! Although you may need to move the hooked end support along the grey drainage hose, DO NOT remove it.

! Whichever drainage method you use, make sure that the hooked end support is fixed level to, or above the 'Plumbing Indicator Line' (see Description page 2).

We recommend one of the following:

Standpipe method:

1. Make sure the standpipe height is a **minimum 500mm** up to a **maximum 1200mm** from the floor.
2. Insert the drainage hose **approximately 100mm** into the standpipe.

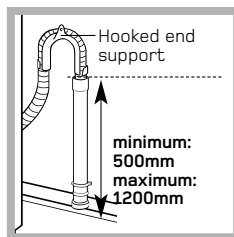

Under sink method:

1. Cut off the blocked end of the under sink drainage unit, or remove the blanking plug if fitted.

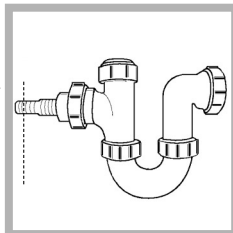

2. Fix the hooked end support a **minimum of 800mm** from the floor.

3. Use a **hose clip** (eg. a jubilee clip) to securely attach the grey drainage hose end to the under sink drainage unit.

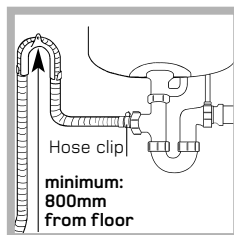

Electrical connections

Before plugging the appliance into the mains socket, make sure that:

- the socket is earthed and in compliance with the applicable law.
- the socket is able to sustain the appliances maximum power load indicated in the Technical Details table (see page 17).
- the supply voltage is included within the values indicated in the Technical Details table (see page 17).
- the socket is compatible with the machines plug. If this is not the case, replace the socket or the plug, ensuring a 13A fuse is fitted.

! The machine should not be installed in an outdoor environment, not even when the area is sheltered, because it may be very dangerous to leave it exposed to rain and thunderstorms.

! When the machine is installed, the mains socket must be within easy reach and should be connected to a suitable electrical supply.

! Do not use extensions or multiple sockets.

! The power supply cable must never be bent or dangerously compressed.

! The power supply cable must only be replaced by an authorised serviceman.

! *The company denies all liability if and when these standards are not respected.*

Before you start using your machine

The first wash cycle

Once the appliance has been installed and before you use it for the first time, run a wash cycle without detergent and no laundry. This will check your installation, connections and drainage and will thoroughly clean the interior before you carry out an actual wash programme on your laundry. This will take approximately 2¹/₂ hours to complete.

! Run the 95° White Cotton programme 'B', without laundry and without detergent.

! During this cycle check for any leaks from under the machine. If present **ensure all hoses are securely tightened.**

Did you know?...

- ...it is very important to ensure that your hoses or cables are not kinked or squashed as this can lead to your machine failing to fill or empty the water.
- ...it is very important to respect the dimensions given within the drainage connection methods (see above).
- ...if using the undersink drainage method remember to cut off the blocked end, or remove the blanking plug.
- ...you will be charged for a service engineers visit if a problem with your machine is caused by incorrect installation or misuse.

GB

Description

Contents

Installation

Control Panel Features

Programmes and Option Modifiers

Detergents and Laundry

Care and Maintenance

Precautions and Advice

Something Wrong? - Troubleshooting

Service

Control Panel Features

GB

Aquarius control panel

***Note:** Depending on the model purchased, your washing machine control panel may differ from the one shown below and have: no variable dial, or only one variable dial either the Variable Temperature or the Variable Spin Speed dial.

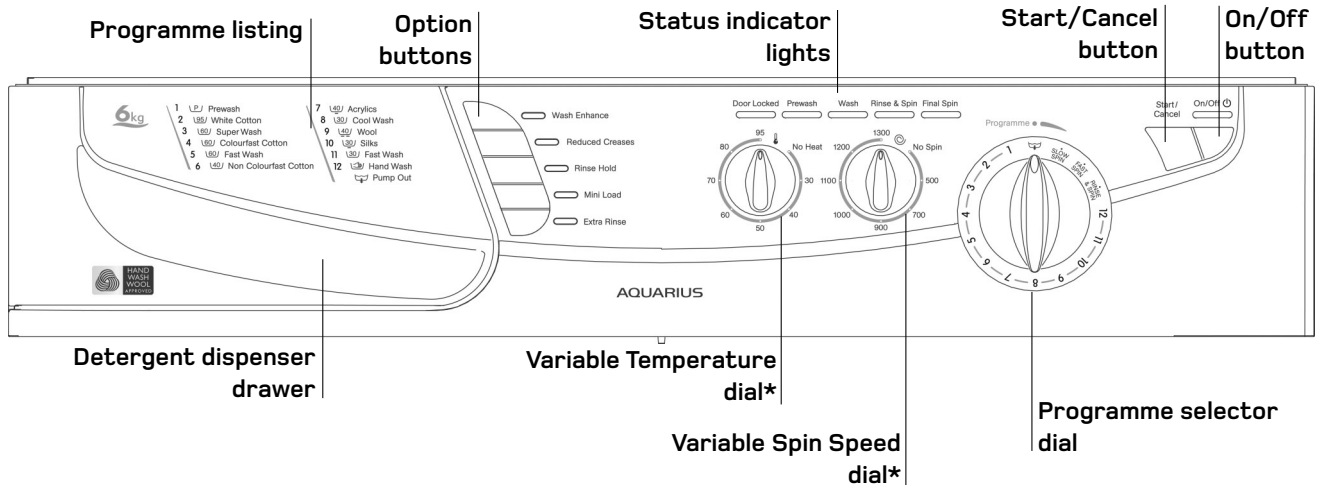

Control panel features

- **Programme listing:** To consult a straight forward chart of the different programmes available.
- **Option buttons:** To select the options available (see *Programme Table and Option Modifiers*).
- **Variable Temperature dial:** To reduce the selected programmes wash temperature*.
- **Variable Spin Speed dial:** To reduce the selected programmes spin speed*.
- **Programme selector dial:** To select the programme you require. The knob stays still during the cycle.
- **Start/Cancel button:** To start the programme, or to cancel it if incorrect settings were selected.
- **On/Off button:** To turn the washing machine on and off.
- **Status indicator lights:** Shows if the door is locked (when lit, the door cannot be opened) and the stage of the programme that the machine has reached (wash, rinse or spin).

Starting a Programme

Starting a typical wash programme

1. Switch the machine **on** by pressing the On/Off button.



2. Sort your **laundry** into groups by washcare labels. Load the machine. Close the machine door by pushing it until it clicks.



3. Add **detergent** and **fabric conditioner** to the dispenser drawer.



! Refer to detergent manufacturer's dosage instructions.

4. Turn the **programme selector** dial to the required programme.



5. Select any **optional wash feature(s)** (see *Option Modifiers*) you require by pressing the appropriate button(s).
- Indicator lights will show what you have chosen.

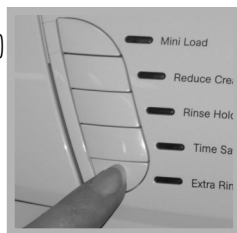

6. Reduce the programmes wash temperature: Turn the Variable Temperature dial to the reduced temperature you require.

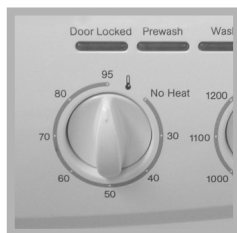

! When the programme has finished return the dial to its maximum setting.

7. Reduce the programmes spin speed: Turn the Variable Spin Speed dial to the reduced Spin Speed you require.



! When the programme has finished return the dial to its maximum setting.

8. **Start** the programme by pressing the Start/Cancel button for at least 3 seconds. The '**Door Locked**' indicator will light up.

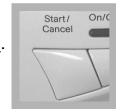

- To stop/change a programme once the machine has started:
 - Press the Start/Cancel button for 3 seconds.
 - Select 'Pump Out' on the Programme selector dial.

- When the machine has finished emptying:
- Turn the Programme selector dial to the new programme required (you may need to add detergent).
 - Press the Start/Cancel button to start the new programme.

9. During the programme, the status indicator lights will show you what **stage in the programme** the machine has reached (wash, rinse, spin).



10. A short time after the programme has finished the '**Door Locked**' indicator will go out and you can open the machine door.

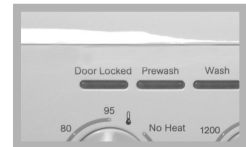

11. Switch the machine **off** by pressing the On/Off button.

GB
Description
Contents
Installation
Control Panel Features
Programmes and Option Modifiers
Detergents and Laundry
Care and Maintenance
Precautions and Advice
Something Wrong? - Troubleshooting
Service

! Do not allow children to play with the machine or tamper with the controls.

! Do not overload the machine. This may damage the laundry and reduce the quality of the wash. The maximum load is 6kg (Cotton).

! Do not try to open the dispenser drawer during any programme.

! Do not try to open the machine door when the 'Door Locked' indicator is lit.

Programme Table

GB

Programme Table *Programme setting for test in accordance with IEC 60456 and EN 60456

ID	Label	Programme Type / Fabric	Description	Temp (°C)	Max Load (kg)	Approximate Programme Time (h : min)	Required Additional Option	Soil Level	Spin Speed	Available Options	Recommended Detergent
1	P	Prewash Mixed	A cool temperature cycle to loosen stains before selecting a main wash programme.	30	6	0 : 25	-	Heavy	-	-	Ariel Bio Liquid
2	95	Hygienic White Cotton	For hard wearing heat resistant cotton and linen.	95	6	2 : 30	-	Normal	Max	Rinse Hold, Mini Load, Extra Rinse	Ariel Bio Powder / Tablets
3	60	Superwash Colourfast Cotton	An intensive cleaning programme for heavily soiled hard wearing fabrics.	60	5	2 : 20	-	Heavy	Max	Reduce Creases, Rinse Hold Mini Load, Extra Rinse	Ariel Colour
4	60	Everyday Colourfast Cotton	For everyday cleaning needs for colourfast cotton or linen fabrics.	60	5	1 : 30	-	Light to Normal	Max	Wash Enhance, Reduce Creases Rinse Hold, Mini Load, Extra Rinse	Ariel Colour
4	60	Standard Colourfast Cotton (IEC 60456*)	An intensive cleaning, energy efficient cycle using the maximum load capacity.	60	6	2 : 00	Wash Enhance	Normal to Heavy	Max	-	Ariel Colour
5	60	Fast Wash Colourfast Cotton	A fast cycle for lightly soiled heat resistant cotton & linen fabrics.	60	5	1 : 00	-	Light	Max	Reduce Creases, Rinse Hold Mini Load, Extra Rinse	Ariel Colour
6	40	Everyday Non Colourfast Cotton	For the everyday cleaning needs of cottons & other hard wearing fabrics.	40	5	1 : 15	-	Light to Normal	Max	Wash Enhance, Reduce Creases Rinse Hold, Mini Load, Extra Rinse	Ariel Colour
6	40	Intensive Non Colourfast Cotton	A less energy efficient intensive 40°C cycle for more stubborn soiling.	40	6	1 : 45	Wash Enhance	Heavy	Max	-	Ariel Colour
7	40	Man-made fibres Coloured Synthetics & Acrylics	A cycle designed to wash a variety of man-made fibres and fibre mixtures.	40	3	1 : 15	-	Normal	800	Reduce Creases, Rinse Hold Mini Load, Extra Rinse	Ariel Colour
8	30	Cool Wash Non Colourfast Cotton	Delivers the same performance as the intensive 40°C cycle but is more energy efficient at the expense of duration.	30	4	1 : 50	-	Normal to Heavy	Max	Rinse Hold, Mini Load Extra Rinse	Ariel Colour Liquid
9	40	Machine Washable Wool	For machine washable wool and wool mixtures.	40	3	1 : 00	-	Normal	850	Wash Enhance	Dreft
9	40	Gold Woolmark Approved Handwash Wool	A special cycle for Hand Wash wool that will not shrink your garments exclusively approved by Woolmark.	40	1	0 : 50	Wash Enhance	Normal	600	-	Dreft
10	30	Machine Washable Silk	For silk garments labelled as machine washable.	30	3	0 : 55	-	Normal	800	Rinse Hold	Dreft
11	30	Fast Wash Mixed (not Wool/Silk/Handwash)	A very short refresh programme for lightly soiled mixed fabrics.	30	3	0 : 30	-	Light	800	-	Ariel Colour Liquid
12	Handwash	Delicates (not Wool/Silk)	A gentle cycle for delicate items labelled as Hand Wash only.	25	4	0 : 50	-	Normal	400	-	Ariel Colour Liquid
R&S	-	Rinse & Spin Mixed	This partial programme completes two full rinses and then a slow spin.	-	3	0 : 30	-	-	800	Reduce Creases, Rinse Hold Mini Load, Extra Rinse	-
FS	-	Fast Spin Cotton	This partial programme completes the maximum speed final spin.	-	6	0 : 15	-	-	Max	-	-
SS	-	Slow Spin Delicates	This partial programme completes the intermediate speed final spin.	-	3	0 : 12	-	-	800	-	-
PO	Pump Out	All	This partial programme ensures the appliance is emptied of water.	-	6	0 : 02	-	-	-	-	-

How much does your laundry weigh?

- 1 sheet 400-500g
- 1 pillow case 150-200g
- 1 tablecloth 400-500g
- 1 bathrobe 900-1200g
- 1 towel 150-250g

A typical wash load... Two examples of maximum wash loads for different types of fabric:

COTTON = 6kg	2 Bath Towels 1 Hand Towel 6 Shirts 6 Blouses 1 Set of Pyjamas 4 Items of Underwear
SYNTHETIC = 6kg	2 Children's Dresses 4 Shirts 4 Blouses 1 Set of Pyjamas 4 Items of Underwear

Option Modifiers and Special Features



Option modifiers

! Not all options can be used on all programmes - (see Programme Table for option availability).

- **Wash Enhance:**
Use this option to select a more intensive wash programme for the cotton 60°C and cotton 40°C for more heavily soiled items. Additionally, use this option on the machine wash wool programme to select the special Handwash wool programme for wool items that are not marked as machine washable. This cycle has been approved by Woolmark for the Gold Care award.
- **Reduced Creases:**
Selecting this option will run the wash programme with a more gentle action and lower spin speed, in addition to carrying out an additional rinse to ensure your laundry has fewer creases and will require less ironing.
- **Rinse Hold:**
Selecting this option will pause the cycle in the final rinse with the fabric conditioner keeping the laundry fresh until you are ready to complete the programme. The Rinse Hold light will flash to indicate the cycle is paused. The machine will stay in this state, tumbling the load occasionally until either the Start/Cancel button is pressed or the Rinse Hold button is pressed again to continue the cycle.
- **Mini Load:**
Use this option for smaller loads less than the capacity listed for the material and programme type (see Programmes Table). This option reduces water consumption and washing time, saving energy when washing smaller loads.
- **Extra Rinse:**
Provides a full extra rinse to ensure the maximum possible detergent removal, particularly useful for people with sensitive skin.
- **Variable Temperature:**
Use this option to reduce the wash temperature below the maximum for the programme you have chosen.
 - Turn the dial to the reduced temperature required.
When the programme has finished reset the dial to 95. If the dial is left at maximum (95), the wash temperature will be the maximum for the chosen programme.
- **Variable Spin Speed:**
Use this option to reduce the spin speed below the maximum for the programme you have chosen.
 - Turn the dial to reduced spin speed required.
When the programme has finished reset the dial to maximum. If the dial is left at maximum, the spin speed will be the maximum for the chosen programme.

GB
Description
Contents
Installation
Control Panel Features
Programmes and Option Modifiers
Detergents
Care and Maintenance
Precautions and Advice
Something Wrong? - Troubleshooting
Service

Option Modifiers and Special Features

GB

Special features

! Not all special features can be used on all programmes - (see Programme Table for option availability).

- **Fast Wash:**

The Fast Wash programmes are designed for lightly soiled loads delivering quick results for smaller loads, using less energy. For loads with stains or increased soil levels which require deeper cleaning, use the standard or intensive wash cycles.

- **Cool Wash: 30°C**

A low temperature wash which delivers cleaning results comparable to the intensive 40°C cotton programme but at a lower temperature for more colour sensitive garments and using less energy.

- **Handwash:**

A gentle action programme for delicate items and items labelled as hand wash only. Not for Wool or Silk garments (use the special programmes for those materials).

- **Handwash Wool Approved:**



The wool wash cycle on Hotpoint machines has been tested and approved by the **Woolmark Company** for washing garments labelled as 'hand wash', provided that the 'garments' are washed in accordance to the instructions issued by the manufacturer of this machine.

This cycle is selected by turning the Programme Selector dial to the wool programme and selecting the 'Wash Enhance' option modifier (see Programme Table and Option Modifiers).

! We recommend using a wool wash liquid when using Wool programmes.

Note: We recommend that if you use colour catcher sheets in your appliance that these only be used inside a wash bag, as otherwise they can affect the performance of your machine.

Did you know?...

- ... when an option button is selected the corresponding light is illuminated.
- ... if the option selected is incompatible with the programme selected, the button will flash and the option will not be enabled.
- ... if you set an option that is incompatible with an option selected previously, only the last option selected will be enabled.

Option Modifiers and Special Features



Automatic features

Unbalanced load detection

The machine has an inbuilt feature to prevent it from spinning too fast with an unbalanced load.

When an unbalanced load is detected, the machine will attempt to redistribute the load in order to balance it evenly to achieve full spin speed.

If this is not possible and an unbalanced load remains the spin speed will be reduced, depending on the amount of unbalance detected. This is to prevent the machine from damaging itself or its surroundings and to prevent excessive noise from the machine.

! If the spin result is unsatisfactory following a reduced spin speed attempt to rectify the unbalanced load, then on completion of the programme the load can be redistributed evenly in the drum by hand. Select a spin cycle.

Note: Do not attempt to spin heavy or absorbent single items as the machine cannot distribute these evenly. If you need to wash a single item you will need to add some other items as ballast to allow the machine to distribute the load evenly throughout the drum.

No water detection

The machine will automatically detect if it cannot take in water and will notify you by...
- flashing the **Prewash** light.

If this occurs please check the appliance is plumbed in correctly (*see Installation 'Water connection'*).

Energy saving and water levels

Modern machines are designed to be as environmentally friendly as possible.

To achieve this water levels are kept to a minimum to ensure they are economic and use the lowest energy possible. *Unlike older appliances you will not see high water levels in the drum during washing.*

! We recommend always washing as close to a full load as possible (*see Programmes Table for the maximum load size of your selected programme*).

GB
Description
Contents
Installation
Control Panel Features
Programmes and Option Modifiers
Detergents and Laundry
Care and Maintenance
Precautions and Advice
Something Wrong? - Troubleshooting
Service

Detergents and Laundry

GB

Detergent dispenser

! Do not put any items into the drawer, other than detergents designed to be released from the drawer, as they may cause damage or blockage.

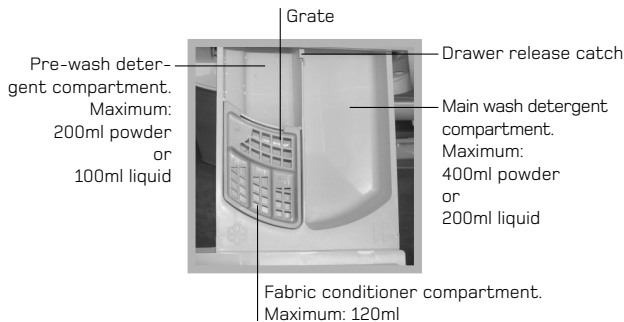

Dispensing powder detergent

To achieve the best wash results the manufacturer's recommended amount of detergent should be measured and added to the main detergent compartment.

Dispensing tablets

Tablets can be dispensed via the **machine drum** or via the **dispenser drawer**.

! Please CHECK the detergent pack for dispensing instructions.

! Incorrect use can damage your laundry.

Dispensing liquid detergent

We recommend the use of a detergent dosing ball, as provided by your detergent manufacturer.

Adding fabric conditioner

Pour the recommended amount of fabric conditioner into the compartment. **Do not** exceed the maximum fill line.

Pre-Wash

When selecting prewash, add detergent to both the pre-wash and the main wash compartments.

Washcare Tips

- **DO NOT overload or underload the machine** (see the *Programme Table* for maximum load), in addition to reducing the quality of the wash this may also damage your laundry and the machine, whilst causing the machine to become unstable and noisy.
- **We strongly recommend that you DO NOT wash underwired bras in this machine.** Should the wires become detached it could cause damage to your laundry and the machine. If the washcare label states that the bra is machine washable, then we advise placing it in a sealed pillow case or a similar washbag.

! Remember you will be charged for a service engineers visit resulting from a detached bra wire.

- Do not use the machine if the item to be washed does not have a wash label.

Before washing laundry we recommend you:

- Pre-treat awkward stains with washable treatments. Do not wash any items that have previously been treated with solvents.
- **Close zips, fasten belts, tie strings and close press studs to prevent tangling.**
- **Empty all objects from pockets as they may damage the laundry and the machine.**

! Remember you will be charged for a service engineers visit to rectify malfunction resulting from objects such as coins, pens, hair grips etc. falling from pockets.

- Limit the size of absorbent loads ie. towels, to half loads to give good washing and rinsing results.
- **Place small items in a wash bag.**
- Always follow the care label on items when choosing the wash programme.
- Wash non-colourfast items or really dirty items separately as they may affect other laundry.

Did you know that with Hotpoint and Ariel you'll get the best washing results?



Certain laundry products work better in some machines than others. At Hotpoint we know this is true because we've done the research to prove it. We used real everyday clothes and ran tests to find out which washing powder works best with Hotpoint. The results proved that Hotpoint and Ariel produces the best washing results on all your clothes.

Ariel can meet all your laundry needs. It is available as a biological powder for everyday wash loads. Colour powder to keep your clothes staying brighter for longer and a Non-Bio powder for when you need brilliant cleaning but are concerned about sensitive skin.

Did you know?...

- ...undissolved detergent left in the drawer or on clothes can be due to incorrect dosing or using the incorrect dispensing method – CHECK the detergent manufacturers instructions on the pack for dispensing and dosage advice.

Cleaning

! Unplug your machine when cleaning it and before all maintenance operations.

! *Do not clean any part of the machine with abrasive cleaners, scouring agents, acids, any bleach or metal polish as they may cause damage.*

- Use a damp cloth or silicon polish to clean the exterior surfaces of the appliance.
- Clean the internal surface of the door bowl regularly with a soft cloth. A build up of soap powder and water hardness residue may result in water leaking from the door.
- Always leave the appliance door ajar to prevent unpleasant odours from forming.

Cleaning the dispenser drawer and compartments

It is advisable to clean the dispenser drawer regularly.

! *Do not try to clean any part of the dispenser drawer while the machine is running.*

1. Pull out the drawer until it reaches its stop.
2. Press the drawer release button to remove the dispenser drawer (see pic).



3. Clean and dry the dispenser drawer, syphons, grate and fabric conditioner exit channel (A), ensuring any build up of detergent and fabric conditioner is fully removed.

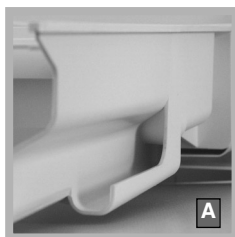

! **Failure to do so may lead to the machine leaking from the dispenser drawer.**

Also regularly clean the outlet pipe area (B).



4. Relocate the dispenser drawer and push it firmly back into place.

! *We recommend a maintenance wash 2 or 3 times a year, to avoid a build up of greasy deposits and water hardness residue. Run the 95° White Cotton programme, with the normal amount of detergent but no laundry.*

Moulded plug

! *The plug must not be used without the fuse cover in place.*

If a replacement fuse holder/cover is required, it must be of the same colour coding or wording as shown on the base of the plug.



Replacements are available from authorised dealers.

Changing the plug

The wires in the power cord are coloured in accordance with the following:

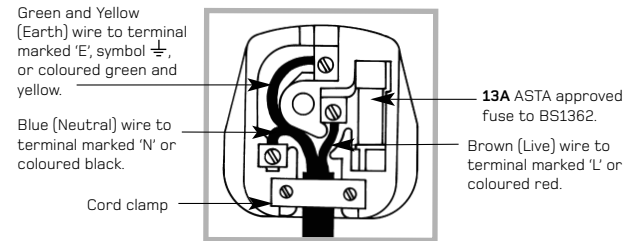

! If the plug being replaced is a non-rewirable type, then the cut-off plug must be disposed of safely.

DO NOT leave it where it can be inserted into a socket and create a shock hazard.

! The power supply cord should be checked periodically and replaced by a cord specially prepared for this machine and fitted only by authorised technicians (see *Service*). Replacement power cords can be purchased, at an extra cost from our Genuine Parts and Accessories department or authorised dealers.

! *The manufacturer denies any responsibility should any of these rules not be followed.*

! **If in doubt about any of the above consult a qualified electrician.**

Cleaning the pump

This appliance is fitted with a self-cleaning pump that does not require any maintenance.

Sometimes, small items (such as coins or buttons) may fall into the pre-chamber that protects the pump.

! *Make sure the wash cycle has ended and unplug the appliance.*

To access the chamber:

1. Remove the kickstrip, on the lower front of the appliance, by holding at each end and pulling towards you (see figure).

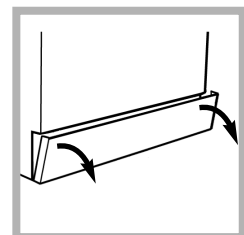

2. Unscrew the pump filter by rotating it anti-clockwise, until it can be removed (see figure). A little water may leak from the pump: this is perfectly normal.

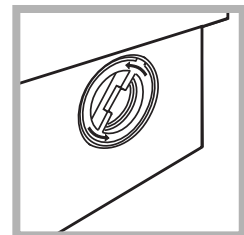

3. Clean the interior thoroughly, removing any visible debris.
4. Refit by screwing the filter into place until it reaches its 'stop' position.
5. Refit the kickstrip, making sure that the hooks are securely in place before you push it onto the appliance.

GB

Description

Contents

Installation

Control Panel Features

Programmes and Option Modifiers

Detergents and Laundry

Care and Maintenance

Precautions and Advice

Something Wrong? - Troubleshooting

Service

Precautions and advice

GB

General safety

- Unplug your appliance when cleaning it and during all maintenance operations.
- This machine should only be used by adults and in accordance with the instructions.
- Do not overload or underload the machine. In addition to reducing the quality of the wash, this may also damage your laundry and the machine.
- Do not pull on the power supply cable to unplug the appliance from the electricity socket. Pull the plug out.
- Do not open the machine door while the appliance is in operation.
- Do not open the detergent dispenser while the appliance is in operation.
- Never force the machine door: this could damage the safety lock mechanism designed to prevent any accidental opening.
- Turn off the water tap after every wash. This will limit the wear of your appliances water system and also prevent leaks.
- In the event of a malfunction, do not under any circumstances touch internal parts in order to attempt repairs.
- Always keep children well away from the appliance while in operation. Do not let children play with the machine or tamper with the controls.
- The appliance door tends to get quite hot during the cycle.
- Should it have to be moved, proceed with the help of two or three people and handle it with the utmost care. Never try to do this alone, because the appliance is very heavy.
- Before loading your laundry into the machine, make sure the drum is empty.
- Check the water fill hose at least once a year. If you see any cracks, replace it immediately: during the wash cycles, high water pressure could cause a cracked hose to split open.
! Never use hoses that have already been used.
- In the unlikely event of something not working - see the Troubleshooting section.

Saving energy and respecting the environment

Environmentally-friendly technology

If you only see a little water through your appliance door, this is because thanks to the latest Hotpoint technology, your machine only needs less than half the amount of water to get the best results: an objective reached to respect the environment.

Saving on detergent, water, energy and time

- To avoid wasting resources, the machine should be used with a full load. A full load instead of two half loads allows you to save up to 50% on energy.

- The pre-wash cycle is only necessary on extremely soiled garments. Avoiding it will save on detergent, time, water and between 5 and 15% energy.
- Treating stains with a stain remover or leaving them to soak before washing will cut down the need to wash them at high temperatures. A pro programme at 60°C instead of 90°C or one at 40°C instead of 60°C will save up to 50% on energy.
- Use the correct quantity of detergent, depending on the water hardness, how soiled the garments are and the amount of laundry you have, to avoid wastage and to protect the environment: despite being biodegradable, detergents do contain ingredients that alter the natural balance of the environment. In addition, avoid using fabric softener as much as possible.
- If you use your machine between late in the afternoon and the early hours of the morning, you will help reduce the electricity board's peak load.

Recycling and Disposal information



As part of Hotpoint's continued commitment to helping the environment, Hotpoint reserve the right to use quality recycled components to keep down customer costs and minimise material wastage.

- Please dispose of packaging and old appliances carefully.
- To minimise risk of injury to children, remove the door and plug - then cut off mains cable, flush with the appliance. Dispose of these parts separately to ensure that the appliance can no longer be plugged into a mains socket, and the door cannot be locked shut.

Disposal of old electrical appliances

The European Directive 2002/96/EC on Waste Electrical and Electronic Equipment (WEEE), requires that old household electrical appliances must not be disposed of in the normal unsorted municipal waste stream. Old appliances must be collected separately in order to optimise the recovery and recycling of the materials they contain and reduce the impact on human health and the environment.



The crossed out "wheeled bin" symbol on the product reminds you of your obligation, that when you dispose of the appliance it must be separately collected.

Consumers should contact their local authority or retailer for information concerning the correct disposal of their old appliance.

Precautions and advice



Safety advice

! This machine was designed and built in compliance with the applicable international safety regulations. The following information is provided for your safety and should be read carefully.

- This machine is designed for domestic use only.
- Before using your machine make sure that the TWO transit bolts, TWO rubber grommets and TWO spacers have been removed (see page 5).
- Any electrical work necessary to install this machine should be carried out by a qualified electrician.
- Do not plug your machine into a socket when your hands are wet.
- Do not try to modify this machine in any way.
- Do not let children play with the machine or with its controls.
- Do not lean on the door or use the door to lift or move the machine.
- Do not wash garments that have previously been treated with solvents.
- Do not connect the machine to a single outlet instantaneous water heater.
- Do not connect the machine directly to a water-softening unit; use the recommended amount of detergent for the water hardness in your area.
- Do not overload or underload the machine. In addition to reducing the quality of the wash, this may also damage your laundry and the machine.
- Do not pull on the power supply cable to unplug the appliance from the electricity socket. Pull the plug out.
- Do not touch the drain water as it could reach very high temperatures (over sink drainage).
- Never force the machine door; this could damage the safety lock mechanism design to prevent any accidental opening.
- In the event of a malfunction, do not under any circumstances touch internal parts in order to attempt repairs.
- Should it have to be moved, proceed with the help of two or three people and handle it with the utmost care. Never try to do this alone, because the appliance is very heavy.
- Before loading your laundry into the machine, make sure the drum is empty.

Technical Details Chart	
Models	WF741, WF546, WF541, WF341, WF326, WF321 and WF101
Dimensions	59.5cm wide 85cm high 60cm deep
Capacity	From 1 to 6kg
Electric connections	Voltage 220/240 50Hz Max absorbed power 1700W-2100W
Water connections	Maximum pressure 1 MPa (10 bar) Minimum pressure 0.05 MPa (0.5 bar) Drum capacity 54 litres
Spin Speed	up to 1400 rpm - WF741, WF546 WF541, WF341 up to 1200 rpm - WF326, WF321 up to 1000 rpm - WF101
Control programme according to IEC60456	60°C cotton (programme 4) with Wash Enhance - run with a 6kg load
	This appliance is compliant with the following European Community Directives: - 73/23/EEC & 93/68/EEC (Low Voltage) and subsequent amendments. - 89/336/EEC, 92/31/EEC & 93/68/EEC (Electromagnetic Compatibility) and subsequent amendments.

GB
Description
Contents
Installation
Control Panel Features
Programmes and Option Modifiers
Detergents and Laundry
Care and Maintenance
Precautions and Advice
Something Wrong? - Troubleshooting
Service

Something Wrong? – Troubleshooting

If your machine seems not to be working, GO through the following troubleshooting suggestions BEFORE you call your Service Centre (see *Service*).

GB

Section 1: All Aquarius Models – General Troubleshooting

Problem:

The machine won't start:
(Nothing lights up on the control panel).

Possible causes / Solution:

- Check the appliance is fully plugged into the socket and switched on.
- Is the socket ok? Try another appliance in the socket to check.
- Is the fuse in the plug ok? If not, replace it, fuse must be 13 Amps (see *Care and Maintenance*).
- There has been a power failure - Check another electrical device in your home to see if this is the case.
- The ON/OFF button has not been pressed.
- The Start/Cancel button has not been pressed, for at least 3 seconds - Press and hold the Start/Cancel button until the machine starts to operate.

Lights illuminate on the control panel but the wash cycle will not start.

- The appliance door is not shut properly - Close the door firmly and try the machine again.
- The Start/Cancel button has not been pressed, for at least 3 seconds - Press and hold the Start/Cancel button until the machine starts to operate.
- The cold water supply tap is not turned on - (Prewash indicator light is flashing).

The machine fails to fill with water.

- The Start/Cancel button has not been pressed, for at least 3 seconds - Press and hold the Start/Cancel button until the machine starts to operate.
- Is the 'Prewash' indicator light flashing? This indicates the machine has failed to take in water (see *Installation*) - Check that:
 - The cold water inlet hose is connected to the tap.
 - The hose is not kinked.
 - The cold water supply tap is turned on... Ensure it is turned fully on.
 - The water pressure is insufficient (see *Technical Details Chart*).
 - The inlet filter is not blocked... Turn off the water, unscrew the fill hose at the back of the appliance then remove and clean the filter.

Note: Modern machines use less water and the water taken into the machine is automatically adjusted depending on the load in the drum. For this reason, you may not always be able to see water in the drum: But if the load is 'wet' and the machine completes the wash cycle then the amount of water into the machine is sufficient.

The machine does not drain or spin (during the first wash cycle, after installation).

- Has the drain hose been installed correctly (see *Installation*).
- Are the drain hose, standpipe or undersink connections blocked?
Note: If the drain hose is connected to an undersink 'U' trap - Check that the sink trap blanking plug was removed before the drain hose was connected. This is the most common installation fault.
- Is the drain hose kinked or squashed - Check the hose at the back of the machine.
- Carry out the additional checks listed below...

The machine does not drain or spin (although it has drained/spun during previous wash cycles).

- There has been an unbalanced load in the drum and the machine could not spin - Try the machine again with a different wash load (see '*Automatic Features; Programmes and Option modifiers*').
- Has the 'Rinse Hold' option been selected? 'Rinse Hold' indicator light will flash.
 - To complete the paused programme press either the Start/Cancel button or the Rinse Hold button (see *Programmes and Option modifiers*).
- Your machine is fitted with a filter system for the pump - This filter may have become blocked (see *Care and Maintenance* for details of how to remove any blockage from the pump filter).
- Has the variable Spin Speed dial been set to 'No Spin'? (see *Programmes and Option modifiers*).

The programme takes a long time.

- If the machine completes the wash cycle, it is unlikely there is a problem.
- Check the programme table to be sure the programme you have selected is that most suited for your needs - The table also gives an indication of approximate programme times you can expect.
Note: The programme times listed in the Programme Table are approximate. Options selected can affect the programme times (see *Programmes and Option modifiers*). The wash load, temperature and pressure of the incoming water supply can cause some variation in the programme times.

There is too much foam in the drum during the wash cycle.

- Check that the detergent you have used is suitable for 'Automatic' machines.
- Refer to the detergent manufacturers recommendations to ensure that you have not used too much detergent.
- If you have used the wrong type of detergent (or too much), select a Rinse programme to flush out your machine.

Steam is coming from the dispenser drawer.

- This is **not** a fault, we have designed the machine to release steam from the drawers during hot washes.

Something Wrong? – Troubleshooting



The machine makes a noise or vibrates too much during the spin cycle.

- The transit fixings were not removed correctly (*see Installation* 'Remove the transit fixings') - Failure to remove **all the parts** of the transit fixings will cause the machine to vibrate excessively during spin.
Note: There are TWO transit fixings that need to be removed – two bolts, two washers, two rubber grommets and two nylon spacers.
- The machine is not level (*see Installation*) - Adjust the feet so that the machine stands firm on the floor (ie, it does not rock) and ensure the machine is level from front to back and from side to side.
- The machine is closed in, between furniture cabinets and the wall (*see Installation*).
- Perhaps the machine was attempting to spin an unbalanced load - Try the machine again with a different was load.
- When you sort your laundry into wash groups, check all loose items, such as coins are removed from the laundry. Check the drum at the end of each cycle and remove any loose items (coins etc).
Note: 'Super Silent' refers to wash sound level only – there will always be some motor and drum noise during spin.

The machine leaks:

- ... from behind or underneath:
 - Check each end of the cold water inlet hose, ensuring connections at **both** ends are tight and not leaking (*see Installation*).
 - Depending on the installation method used (*see Installation*). Check that:
 - the drain hose is firmly secured to the undersink 'U' trap, or...
 - the drain hose is positioned correctly into the standpipe.
 - Check that your water pressure is within limits (*see Technical Details Chart*).
 - If too high, try turning the cold water supply tap down slightly and try the machine again (*see Installation*).
- ... from the dispenser drawer (water leaking down the front of the machine):
 - Check that the detergent dispenser is not blocked or obstructed.
 - Remove the drawer from the machine and clean it (*see Care and Maintenance*).

Not all the detergent has been flushed out of the dispenser drawer.

- Check the cold water supply tap is turned on sufficiently (*see Installation*).
- Is your water pressure is within limits (*see Technical Details Chart*), if it is too low it may not be sufficient to flush all the detergent out of the drawer.
- Check that the detergent dispenser is not blocked or obstructed.
 - Remove the drawer from the machine and clean it (*see Care and Maintenance*).
- Is your water pressure too low? (*see Technical Details Chart*).
Note: Are you using detergent tablets? – If yes, please check the detergent manufacturers instructions on the side of the detergent box, not all detergent tablets are suitable for use in the dispenser drawer some need to be placed into the machine drum with the wash load for them to dissolve correctly.

The dispenser drawer will not close properly or is collecting water.

- Check that the detergent dispenser is not blocked or obstructed.
 - Remove the drawer from the machine and clean it (*see Care and Maintenance*).

Section 2: Specific Error Messages on the Control Panel

Your machine carries out automatic checks at various stages of the wash cycles - Error messages will be displayed on the control panel to indicate there is something wrong.

The error message displayed is dependent upon which machine you have:

Error message:

'Prewash' indicator light flashing on the control panel

- This indicates that the machine has failed to take in water** (*see Installation*).
- Check that:
- the cold water inlet hose is connected to the cold water supply tap.
 - the cold water inlet hose is not kinked.
 - the cold water supply tap is turned on... Ensure it is turned fully on.
 - the water pressure is sufficient (*see Technical Details Chart*).

'Door Locked' indicator light flashing on the control panel

- This indicates that the door is not closed properly.**
- Close the door firmly and try the machine again.

'Wash Enhance' and 'Rinse Hold' and 'Mini Load' option indicator lights flashing on the control panel

- This indicates that the machine failed to drain, possibly because the pump filter is blocked.**
- Your machine is fitted with a filter system for the pump - This filter may have become blocked (*see Care and Maintenance*) for details of how to remove any blockage from the pump filter.

GB

Description

Contents

Installation

Control Panel Features

Programmes and Option Modifiers

Detergents and Laundry

Care and Maintenance

Precautions and Advice

Something Wrong? – Troubleshooting

Service



GB

Before calling the Service Centre:

- Use the troubleshooting guide to see if you can solve the problem yourself (see Troubleshooting).
- If not, turn off the machine and call the Service Centre closest to you.

! You will be charged for a service engineers visit if a problem with your machine is caused by incorrect installation or misuse.

Spare Parts

This is a complex machine. Repairing it yourself or having a non-authorized person try to repair it could cause harm to one or more persons, could damage the machine and could invalidate the spare parts warranty.

Call an authorized technician if you experience problems while using the machine.

The spare parts have been designed exclusively for this appliance and not for other uses.

Key Contacts

After Sales Service

Over 1100 trained specialists, directly employed by us, ensure that you can have complete confidence in both the appliances and services we offer.

Repair Service and Information Help Desk

UK: 08709 066 066

Monday to Friday, 8am to 7.30pm

Saturday, 8.30am to 5.30pm

Sunday, 9.30am to 3.30pm

www.hotpointservice.co.uk

Republic of Ireland: 0818 313 413

Note: Our operators will require the following information:

Model number

Serial number

Date of purchase

Model number and Serial number can be found on the inside of the door.

Extended Warranties

UK: 08709 088 088

Monday to Sunday, 8am to 8pm

www.hotpointservice.co.uk

Republic of Ireland: 0123 002 333

Genuine Parts and Accessories

UK: 08709 077 077

Monday to Friday, 8.30am to 5pm

Saturday, 8.30am to 12noon

www.hotpointservice.co.uk

Republic of Ireland: 0818 313 413

www.hotpoint.co.uk