

Twin-tub Washing Machine

User's manual

Haier

This manual is for
HWM60-113S





- Please read this manual carefully before using.
- Retain it for future reference.

Haier

Contents

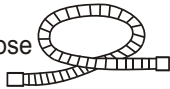
| | |
|---|----|
| ●Names of the parts..... | 1 |
| ●Safety precautions..... | 2 |
| ●Installation and adjustment | 4 |
| ●Preparation before washing | 6 |
| ●The musts in washing | 7 |
| ●Usage of the detergent..... | 7 |
| ●Washing sequence | 8 |
| ●Disposal after washing..... | 12 |
| ●Trouble-Shooting *Answers to question..... | 14 |
| ●Packing list *Specification..... | 16 |

Packing list

| Name | Quantity |
|---|-------------|
| ● User's manual | ● One piece |
| ● Water inlet hose  | ● One piece |
| ● Lint filter  | ● One piece |
| ● Water-filling jointer  | ● One piece |
| ● Gland  | ● One piece |
| ● Twin-tub washing machine | ● One set |



Specification

| | |
|--|---------------------------------|
| Water level / Water quantity (about) (L) | Maximum/43 Medium/36 Minimum/30 |
| Standard rated washing capacity(kg) | 6.0 |
| Standard rated spinning capacity(kg) | 5.0 |
| Injection pressure(MPa) | 0.02~0.2 |

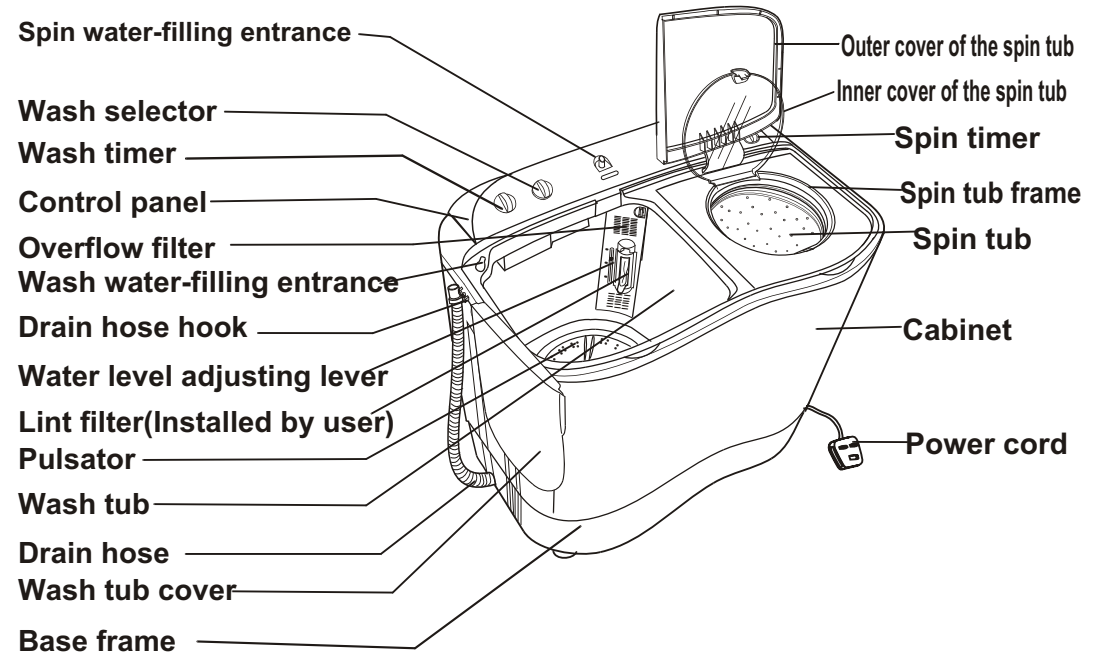
Names of the parts



Meaning and description of the symbols

| | |
|--|---|
| <p>Warning sign</p>  | <p>Contents marked with that symbol are related to the safety of the product and the personal safety of the users. Please operate in strict conformity to the contents, otherwise it may cause damage of the machine or injure the personal safety of the user.</p> |
| <p>Forbidding sign</p>  | <p>Contents marked with that symbol are actions forbidden to perform. Performing of those actions may result in damage of the machine or injure the personal safety of the user.</p> |

Please check if the power receptacle has good earthing condition before using to guarantee your safety.

Safety precautions

Please insert the power cord into special receptacle with rated voltage. Be sure to use single-phase three pins receptacle. The earthing terminal of the receptacle must be earthed reliably. If possible, please adopt electric leakage protector.

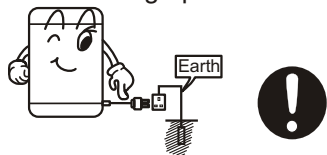

When the machine is normally using, please put the power plug at the location easily to be inserted and extracted by hand. Be sure to pull the plug off when there's power failure, or the machine is being moved, cleaned or when it is idle.



If the power cord is bad, to avoid risk it is required to replace it by the technicians of our special shop or the after-sale service department. Keep the pin of the power plug clean.



Do not put the machine at damp place like the bathroom. Never wash it with water. Do not place wet laundries on the control panel.

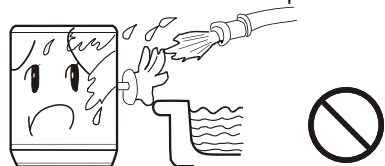

Do not use water hotter than 50°C.



In case the washing machine is installed on ground with carpet, do not block the ventilation hole with carpet.

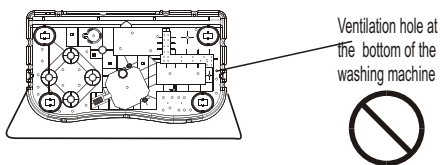

Ventilation hole at the bottom of the washing machine

Do not wash water-proof laundries like the raincoat, bike covers etc. to avoid abnormal vibrations in spinning.



Do not let the machine share one receptacle with other electric appliances. If the power plug is damaged, or the plugging into the receptacle is loose, do not use the plug any more.

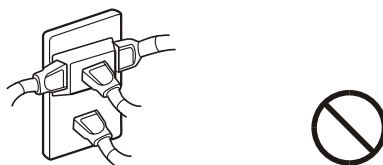

Trouble-shooting Answer to question

(If there's breakdown, please pull off the power plug before checking) The following phenomena are not breakdowns sometimes. Please confirm again before sending it to repair. If there are real breakdowns, please come to the special maintenance department or after-sale service department of our company. Do not repair it by yourself.

| Phenomena | The reason |
|---|--|
| The machine does not act. | <ul style="list-style-type: none"> • Is there power failure? • Is the power plug loose? • Is the pulsator twisted by foreign materials? |
| The draining does not work | <ul style="list-style-type: none"> • Is the drain hose put down? • Is the drain hose frozen? • Is the drain hose blocked by foreign material? • Are there laundries falling to the outer side of the spin tub? |
| There's abnormal sound during washing | <ul style="list-style-type: none"> • Are there hair pin, coins or metal items brought inside the tub? |
| There's abnormal sound and violent vibration during spinning | <ul style="list-style-type: none"> • Is the machine slanting? • Is the gland pressed evenly? • Are there laundries falling to the outer side of the spin tub? • Are the laundries in spin tub too much? |
| There may be some waterflowing out of the drain hose in the first use of the machine. | <ul style="list-style-type: none"> • It is the water remained in the factory inspection of performance. |

Trouble-shooting Answers to question

If the laundries fall to the outer side of the spin tub

If the laundries fall to the outer side of the spin tub, please take them out immediately.

1. Dismantle

As indicated in the figure, push the point marked with "※" to pull the spin tub frame to oblique upwards to dismantle it.

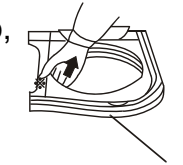

Spin tub frame

2. Install

After install the back edge of the spin tub frame to proper position, push the four points marked with "※" by force to reset it.

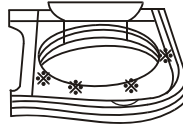

Please check carefully. The laundries may fall to the lower part of the outer side of the spin tub (as indicated in the figure).

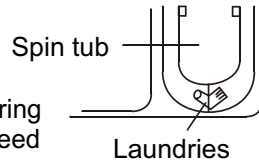

If the laundries fall to the outer side of the spin tub, during spinning the draining will get blocked and the rotation speed of the spin tub is reduced.)

When the remained water is frozen

- Prevent the freezing (be sure to discharge the water completely after using)
- After complete draining, set the "WASH SELECTOR" at "STRONG" or "STANDARD". If it is set at "DRAIN", it will be rather difficult for the frozen water to melt.

● When the water is frozen

Pour hot water below 50°C into the wash tub to soak it completely. Then turn the pulsator with hands gently. Please confirm the drainage can work normally before next using.

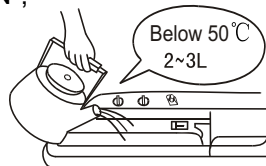

Safety precautions

Do not stretch hands into the working machine. It is dangerous even if the rotation is slow. Take special care of the children.



Do not decompose, repair or alter the machine by yourself.

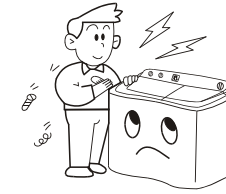

Do not put any hot or heavy items (such as the kettle with hot water) on the washing machine.



Do not wash laundries with volatile materials (such as thinner, petrol etc.)

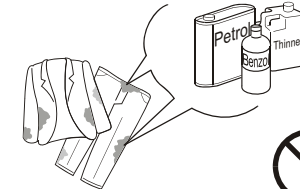

Handicapped or children without care shall not use the machine.

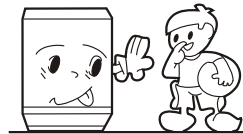

Keep the machine away from direct sunlight and heat source like the heater.



● To protect your laundries and washing machine, please take out all of the coins, buttons, sand, hairpin and other foreign materials before washing.



- Please check if the water faucet is open, and if the connection of the water inlet pipe is proper.
- It is suggested to use foamless washing powder.

Installation and adjustment

Please install and adjust the machine according to the requirement of the manual. It is very important to your security and correct operating the machine.

Install the lint filter

After opening the package, please take out the lint filter from the document bag, install it to the overflow filter of the wash tub. See to the figure.

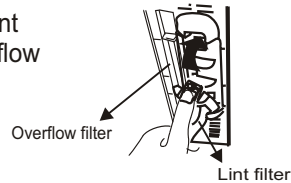

Usage of the drain hose

The drainage shall be smooth with the drain hose.

1. The height of the drain hose shall be less than 10cm, or the drainage will not be smooth enough and cause incomplete drainage.

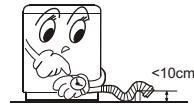

2. Do not tramp or press the drain hose.



3. If the drain hose is too long, cut it at mid point. To make smooth drainage, cut the front end of the hose slantingly.

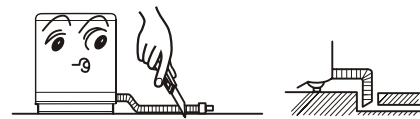

4. If extra drain hose is needed, please make separate purchase. The inner diameter of the extra hose shall not less than 30mm, and the length shall not exceed 1.5m.

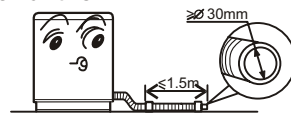

If the extra hose is too long, cut it either at point A or B.

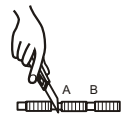

Cleaning the overflow filter

2. Take off the corrugation pipe. Dismantle the upper part of the corrugation pipe inside the overflow filter (as indicated in Figure 1).

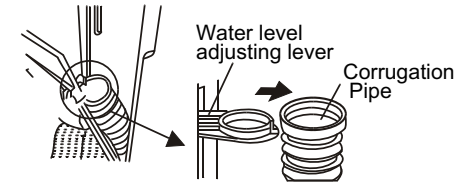

Figure 1

3. Cleaning the overflow filter. Clean the lint around the filter and flush with tap water.

4. Install the overflow filter.

- (1). Install the corrugation pipe.
- (2). Insert the mounting plate at the bottom of the filter into the valve cover.
- (3). Hang up the hook at the left upper side.
- (4). Push the upper part in as indicated in Figure 2.

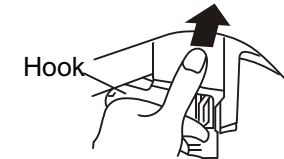

Figure 2

Disposal of the complete unit

- Wipe the complete unit with soft cloth twisted dry.
- Wipe with neutral detergent if too dirty
- Do not wash it directly by water



- After washing, dismantle the water inlet hose.
- Do not store water in the tub for long period. Discharge the water immediately after each using.
- Pull off the power plug and hang up the power cord.
- Hang up the drain hose. Wipe off the water drops on the surface and inside the tub with clean soft cloth.
- Open the cover of the wash tub and the inner/outer cover of the spin tub for some time (about one hour), then close them.

Disposal after washing

- After using, please clean the lint and eyewrinker of the lint filter and overflow filter in time. Otherwise it may influence your using the machine.
- Please first pull off the power plug from the receptacle before cleaning.

Cleaning the lint filter

- The lint filter must be used during washing.
- It must be cleaned in time after each using.

1. Take off the lint filter
Put hand at the indicated position. Push down to take it off. (See Figure 1)



Figure 1

2. Clean the lint
Put it in water and clean while it is still wet. (See Figure 2)

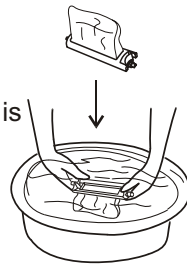

Figure 2

3. Install the lint filter
After cleaning, insert the bottom of the lint filter (marked with "down side") into the overflow filter, then push the upper part of the filter in (marked with "up side"). (See Figure 3)

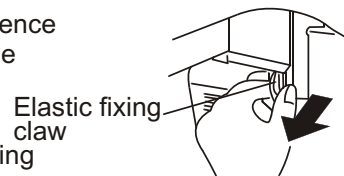

Figure 3

Cleaning the overflow filter

- Too much lint on the overflow filter will influence the normal usage of the machine. Please clean it every two months.

1. Take off the overflow filter.
As indicated in the figure, nip the elastic fixing claw and pull it to the direction of the arrow to take it off.



Elastic fixing claw

How to change the direction of the drain hoses

- Figure 1 indicates the ex factory installation position of the drain hose.

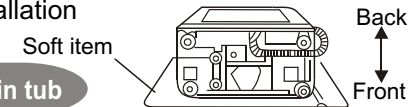

Figure 1

Extend the drain hose from the side of spin tub

- Put soft items on the ground. Lean the machine down gently with the front surface facing the ground. Take off the drain hose from the cabinet. Take the hose out of the fixing groove. (See to Figure 2).

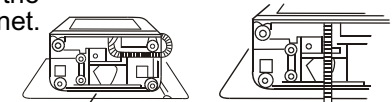
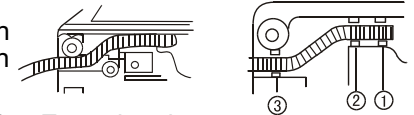

Figure 2

- Embed the drain hose into the groove along the side of the spin tub in the order of (1)~(3), heading for the side of the spin tub. (See to Figure 3).



Embed into the groove in turn

- Embed the drain hose into the groove with hands. Take care not to damage the drain hose in fastening the fixing clamp.

Extend the drain hose from the rear side

- Take out the drain hose from the fixing groove. Extend it from the rear side as per the direction of the arrow. (When the drain hose is extended from the rear side, it can be hung on the point for drain hose at the two sides of the cabinet.) (See to Figure 4).

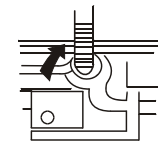
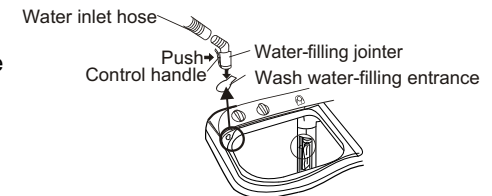

Figure 4

Install the water inlet hose; Select the water level

Insert the water inlet hose into the water-filling entrance, then push the water-filling jointer into the wash water-filling entrance on the major frame. (To dismantle the water inlet pipe, just push the control handle as indicated in the figure and pull it out)



Select water level according to the quantity of the laundries.

- Set the water level adjusting lever to needed line.

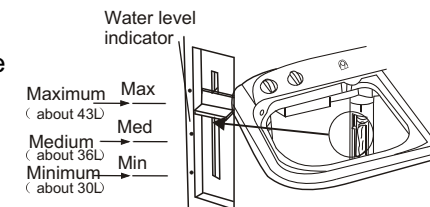

Preparation before washing





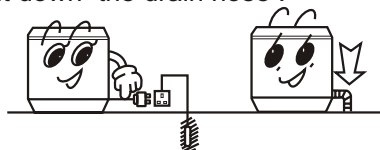

Preparation before washing

1. Connect the water inlet hose.
2. Confirm that the washing machine is earthed reliably. Then insert the power plug into the receptacle. Do not connect the earth terminal to the gas pipe and tap water pipe.
3. Put down the drain hose.



4. Slanting or uneven ground may result in unstable working or abnormal noise. Please make the machine stand horizontally.

Pay attention to followings before washing the laundries

| | | | | |
|---|---|---|--|---|
| Check if the laundries has special requirement on washing | Clear the pocket. Take out the coins, sand, hairpins etc. | Tie the long strips; fasten the buttons; close zippers. | The quantity of the laundries shall not be too large. Stretch and loosen the laundries before putting them in the tub. | When the pulsator is running, the buttons of the laundries may cause noise. For the sake of discretion, please put the laundries with buttons into other laundries. |
| |  |  |  |  |

- a. Check if the laundries are applicable for washing with machine.
- b. Divide the laundries that are not colorfast from other laundries.
- c. Put those laundries difficult to absorb water into water with hand.
- d. For those laundries with heavy soil, please first remove the dirt like mud or dust. For the parts with heavy soil, please apply detergent on them in advance, which can make it easier to remove the soil.
- e. For those laundries that may get lint ball and those with long fur, turn it over before putting in.
- f. Do not put those laundries polluted by chemicals into the washing machine directly.

Spinning

1. Put the laundries into the spin tub evenly and smoothly.

2. Press the gland in the tub properly. Close the inner and outer cover of the spin tub.

3. Spin
Select suitable spin time according to the laundries, and do spinning.

Selection of the spin time list 3

| Laundries | Spin time (minutes) |
|-------------------------|---------------------|
| Bed sheet or blanket | About 4~5 |
| Underwear (knitwear) | About 2~4 |
| Swear (chemical fiber) | About 1~2 |
| Blending thin laundries | Within 1 minute |

During spinning, if there's abnormal sound, it is generally owing to slanting placement of the laundries. Please stop the machine and re-order the laundries.

- In spinning, it will pause the work if you open the outer cover of the spin tub. Close it to resume the spinning.



To do spinning and draining or rinsing with water-filling together, please first do spinning for around 1 minute, then do draining or rinsing with water-filling. Otherwise the spinning will stop owing to too much water stored in the spin tub.

Rinsing

Rinse with water-filling

1. Put the laundries into the wash tub. Select suitable current according to the laundries.

Page 8



2. Adjust the water level
Set the water level with water level adjusting lever according to the laundries quantity. Then fill suitable water continuously.

3. Rinse
Adjust the wash timer to 5-7 minutes to do rinsing.

Rinse with stored water (Repeat the midway spinning and rinsing with stored water for 2-3 times)

1. Put the laundries into the wash tub. Select suitable current according to the laundries.

Page 8



2. Fill water to preset water level.
 3. Rinse
Adjust the wash timer to 2-3 minutes to do rinsing.
- When the laundries quantity is below 2.4kg, please use "STANDARD" current. If you use "STRONG" current, it may splash.

The musts in washing



- The capacity of washing and spinning of the machine refer to the largest weight of the standard laundries under dry condition that can be washed or spinned in one time. Laundries quantity in one washing cycle shall be lower than the rated capacity. The wash standard capacity of this machine is 5.8 kg. The spin standard capacity of this machine is 5.0 kg
- The thickness, size, type of the cloth will influence the actual washing capacity. It is suitable to put in reasonable amount of laundries and the laundries can be turned round in washing for one time washing.
- Do not select "Maximum" water level for laundries less than 2.4kg, so as to avoid splashing of water.
- It is suggested not to use high sudsing detergent.

Usage of the detergent

How to use the whitener

- Fill water to decided level. Dilute the whitener with container. Pour it slowly into the washing tub.
- Avoid using whitener on laundries with color or pattern as they are prone to lose color.
- The whitener shall not touch the laundries directly.
- Refer to the user's manual for the usage and quantity of the whitener.
- For powder whitener, please dissolve it before using.

How to use the washing powder

- Direct dissolved in the machine:
 1. Fill small quantity of water.
 2. Add the powder. Run for 30 seconds to dissolve it completely.
 3. Put it in the laundries. Select suitable water level.
- The instant dissolving of the washing powder:
 1. Prepare warm water of 30°C and a container.
 2. Add the powder while stirring to fully dissolve it.
- The powder is more prone to pollute the laundries than the detergent. Therefore please use it with proper quantity.
- Dosage of different washing powder is different. Please refer to the instruction of the washing powder for the detail dosage.

Washing sequence

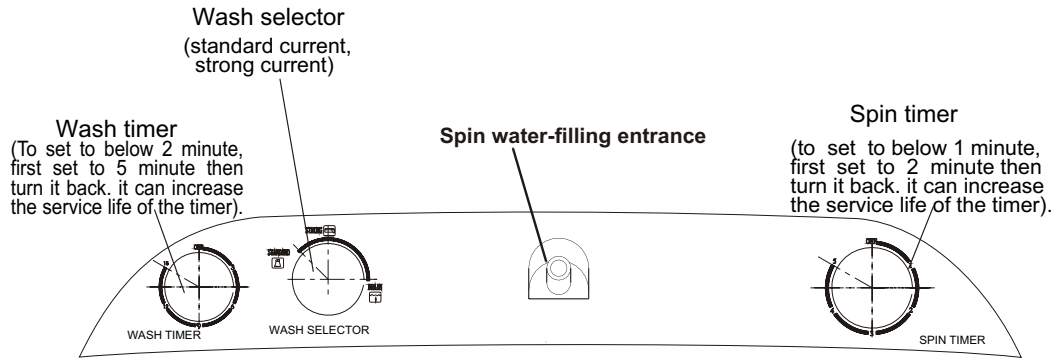

Wash

1. Fill the water and add the dissolved washing powder to make the water level reach the preset position. (Figure 1)
Run washing program for some time to stir and dissolve the powder completely.



Figure 1

Page 7

2. Put in the laundries. If the water quantity is insufficient, please add water.

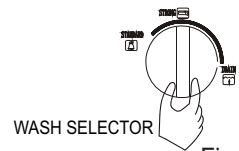

Figure 2

3. Select the current.
Select the strength of the current according to the laundries. (Figure 2)

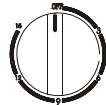

Figure 3

4. Select the washing time
Select the washing time according to the laundries. (Figure 3)

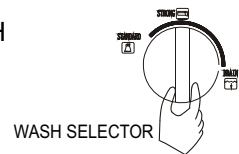

Figure 4

5. After washing, the buzzer will ring. Set the "WASH SELECTOR" at "DRAIN". (Figure 4).

Midway spinning

1. Put the laundries into the spin tub evenly and smoothly.

2. Spin:

- (1) Put the gland in properly.

- Please put in the gland properly even if the laundries quantity is small.

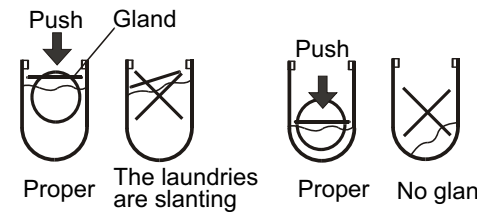

- (2) Close the inner and outer cover of the spin tub.

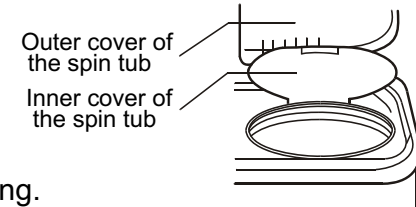

- (3) Spin for 1-2 minutes.

3. Run the foam-removing spinning.

- (1) Open the outer cover of the spin tub.
- (2) Insert the water inlet hose into the spin water-filling entrance on the control panel. Fill water for about 1 minute.
- (3) Close the outer cover of the spin tub. Spin for 1-2 minutes.

