

MARGHERITA

ALD 10

Instructions for
installation and use



The secrets of fabrics

How to get better results

■ "A" wash performance

The first washer-dryer
to give a perfect wash
at only 40°C

■ Assistance, Spare parts and Acces- sories?

Call your nearest
Customer Service
Centre or dial
0870 607 0805

Margherita
Washer-dryer
safe

and easy to use

 **ARISTON**

Quick guide to Margherita

Here are the 13 topics explained in this manual. Read, learn and have fun: you will discover many secret ways to get a better wash, more easily and making your washer-dryer last longer.....and especially keeping an eye on safety.

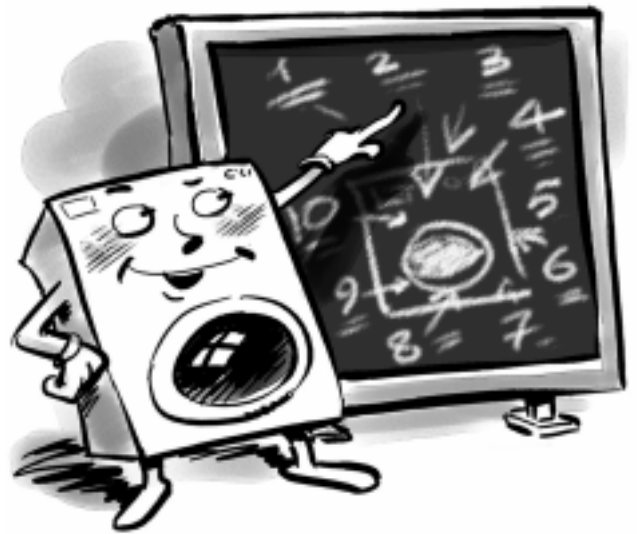

1. Installation and removal (p. 11)

Installation, after delivery or transport, is the most important operation for the correct functioning of your Margherita washer-dryer. Always check:

1. That the electric system complies with the law;
2. That the inlet and draining pipes are connected correctly. **Never use hoses that have already been used, always use the new ones provided with your machine.**
3. That the washer-dryer is levelled properly; something worth checking for the life of your washer-dryer and the quality of your wash;
4. That the drum's fixing screws have been removed from the back of the washer-dryer.

2. What goes in your washer-dryer and how to start it (p. 2)

A correct distribution of your laundry is vital to both the successful outcome of the wash and the life of the washer-dryer. Learn all the tips and secrets to dividing your linen: colour, type of fabric and tendency of creating fuzz are the most important criteria.

3. Guide to understanding labels (p. 6)

The symbols on the labels of your garments are easy to understand and equally important for the success of your wash. The guide includes simple instructions to help you choose the right temperature, wash cycles and ironing methods.

4. Useful tips to avoid mistakes (p. 7)

Years back, our grandmothers were the ones who gave us good advice - and in those days synthetic fibres did not exist: washing was easy. Today, Margherita offers you helpful advice allowing you to wash cashmere and wool even better than an expert laundress would by hand.

5. The detergent dispenser (p. 8)

How to use the detergent dispenser.

6. Understanding the control panel (p. 3)

Margherita's control panel is very simple. It has only a few essential buttons to help you choose any type of wash cycle, ranging from the most energetic, capable of cleaning a mechanic's overalls, to the most delicate for cashmere. Familiarising with it will help you get the best out of your wash while helping your washer-dryer last longer. It's easy.

7. Guide to Margherita's programmes (p. 4)

Herein is an easy table to help you choose the right programme, temperature, detergents and possible additives. Choose the right programme and you will get better results with your wash while saving time, water and energy, day after day.

8. How to dry (p. 5)

A few handy tips to get the best drying cycle from your appliance.

9. Care and maintenance (p. 13)

Margherita is a true friend. With just a bit of care, it will repay you with loyalty and devotion. With the necessary upkeep, it will wash for years and years to come.

10. Problems and solutions (p. 9 and 10)

Before calling a technician, read these pages: immediate solutions may be found for a number of problems. If the problem persists, call Ariston customer services and any failure will be repaired, as soon as possible.

11. Technical characteristics (p. 10)

Herein are the technical features of your washer-dryer: model type number, electric and water specifications, size, capacity, speed of the spin cycle and compliance with Italian and European rules and regulations.

12. Safety for you and your children (p. 14)

Here you will find the necessary guidelines for the safety of your entire household, because safety is very important indeed.

13. Ariston stays with you after your purchase (p.15)

Ariston supports its products after their purchase by offering you a range of special services, professional assistance, spare parts and quality accessories.

What goes in your washer-dryer?

Before washing, you can do a great deal for better results. Divide your garments according to fabric and colour. Read the labels, follow their indications and alternate small items with large ones.

Before washing.

Divide your washing according to the type of fabric and colour resistance: sturdy fabrics should be separated from delicate ones. Light colours should be separated from dark ones. Empty all pockets (coins, paper, money and small objects) and check the buttons. Mend immediately or remove loose buttons as they could fall off during the wash cycle.

The labels say it all.

Always look at the labels: they tell you everything about your garment and how to wash it in the best way possible. The table on page 6 shows you all the secrets of the symbols found on labels. Their indications are a valuable guide to a better wash and to longer lasting clothes.

Big and small happily together.

This washer-dryer has a special electronic control device for distributing the wash load evenly: before the spin cycle starts, this device allows the washing to position itself as uniformly as possible in the drum, according to the type of

Dividing your garments according to fabric and colour, is very important for good results

washing and initial positioning. For this reason, even at top spin, the washer-dryer does not vibrate or make any noise.

Starting Margherita

After installing your new washer-dryer, start a wash cycle by setting programme "1" at 90 degrees.

Starting Margherita in the right way is important for the quality of your wash, for preventing problems and for lengthening the life of your appliance. After loading your washing and pouring in the detergent together with any additives, always check that:

1. The door is correctly shut.
2. The plug is inserted in the socket.
3. The water tap is open.
4. Selector knob **A** is positioned on one of the symbols ● (Stop/Reset).

Choose the desired programme

The programme is selected according to the type of garments that need to be washed. To choose a programme, refer to the table on page 4. Turn knob **A** until the selected programme coincides with the pointer situated on the upper part of glass **I**, make sure knob **B** is in the required position and, if necessary, use buttons **D**, **E** and then press on/off button **F** (position **ON**).



For more delicate garments: protect underwear, tights and stockings and delicate items by placing them in a canvas pouch

Remember that, if you want to use it, the "programmed start" should be set before the wash cycle.

At the end of the wash cycle...

Lamp **G** will flash quickly for a few seconds, then it will begin flashing more slowly. Then turn Margherita off by pressing on-off button **F** (**OFF** position).

You can now open the washer-dryer door safely. After having removed the freshly cleaned washing, leave the door open or ajar so that the humidity left inside can evaporate.

Always close the water tap. **Remember that, in the event of a power failure, or should the washer-dryer switch itself off, the programme chosen will be memorised.**

How to eliminate the most common stains

Ink and biro Dab with a wad of cotton soaked in methyl alcohol or alcohol at 90°.

Tar Dab with fresh butter, rub in turpentine then wash immediately.

Wax Scrape away, then run a hot iron between two sheets of absorbent paper. Then rub in cotton with turpentine or methyl alcohol.

Chewing gum Rub in nail polish remover and wipe with a clean rag.

Mold Cotton and white linen should be placed in a solution of 5 parts water, one bleach and a spoon of vinegar, then washed immediately. For other white fabrics, use hydrogen peroxide at 10 volumes and wash immediately.

Lipstick Dab with ether on wool or cotton. Use trichloroethylene for silk.

Nail polish Place a sheet of absorbent paper on the side of the stain, wet it with nail polish remover, shifting the garment as the sheet gradually changes colour.

Grass Dab with a wad of cotton soaked in methyl alcohol.

Here I'm in command

Making the right choice is important. And it's easy.

A Programme selector knob and programmed start
Use this knob to select the wash programme.

Turn this knob clockwise only.
To select a programme, you should turn the knob so that the symbol/number of the desired programme is in line with the pointer on the glass I.

Now press on/off button F (position ON), pilot lamp G will start flashing.

After 5", the setting will be accepted, pilot lamp G will stop flashing (staying lit) and the wash cycle will begin.

Should you wish to interrupt the programme in progress or set a new one, select one of the symbols ● (Stop/Reset) and wait 5" : when the cancellation has been accepted, pilot lamp G flashes, and you can then turn the appliance off.

You can use this knob to delay the appliance's operation.

Select one of the 3 delay time positions, press the on/off button F (position ON) and wait 5". The setting has now been accepted (pilot lamp G stays lit) and you can select the programme you desire.

Pilot lamp G has a particular flashing motion (2" on and 4" off) to indicate that a delayed start has been set.

During this phase, you can open the appliance door and change the washing load, should you wish to do so.

After the wash cycle has been set and accepted by the washer-dryer, turning the knob will have no effect (except for when it is on position ● Stop/Reset).

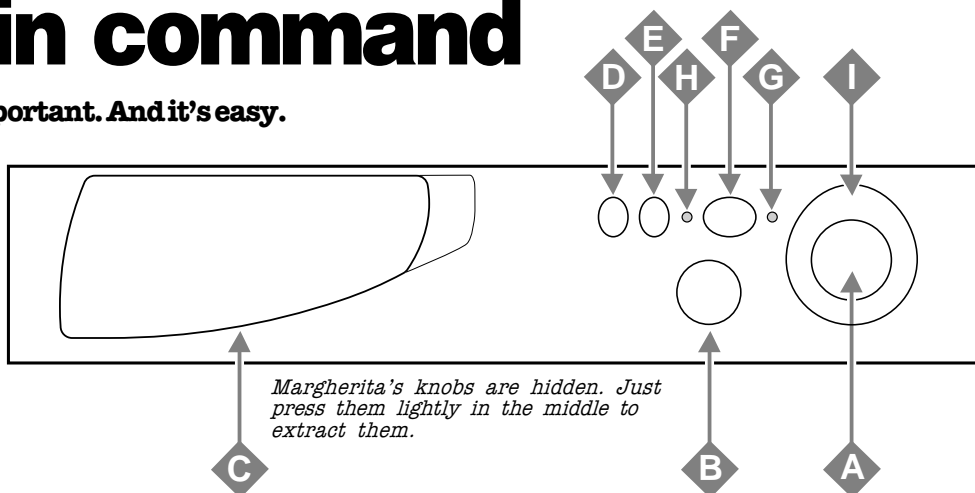

B Drying cycle knob
Use this knob to select the desired drying cycle. Two options are available:

A - Based on time:
From 40 minutes to 150.

B - Based on the damp level of the dry clothes:

Iron ☹️: slightly damp clothes, easy to iron.

Wardrobe ☹️☹️: dry clothes to put away.

Extra dry ☹️☹️☹️: very dry clothes, recommended for towelling and bathrobes.

A cooling stage is foreseen at the end of the drying cycle.

C Detergent dispenser
It is divided into three compartments:

1. Detergent for pre-washing;
2. Detergent for the wash cycle;
3. Fabric softeners, starches, perfumes.

D Rinse-hold
This button allows you to interrupt a programme (on symbol ▲) keeping the washing soaking in water before the spin cycle. It is a very useful button in particular because it can be used for delicates and synthetics. It is

only to be used with wash programmes for synthetic fabrics, silk and curtains when it is impossible for you to take the washing out immediately. Before opening the washing machine door, finish the wash cycle as follows:

Silk and curtains: press button D and Margherita will drain the water.

Synthetic fabrics: press button D if you want a spin cycle, or turn knob A to symbol ☹️☹️☹️ if you want the water to be drained.

N.B.:

- when setting a drying cycle, this function is not performed.
- with "Daily wash" or "Hand wash", this function is not performed.

E Slow spin
Use this button to reduce the spinning speed from 1000 to 500 rpm for the cotton programmes and from 850 to 500 rpm for the synthetic fabrics programmes.

F On-off
When button F is pressed, the washer-dryer is switched on, when it is not the machine is switched off. **Turning the appliance off does not cancel the selected programme.**







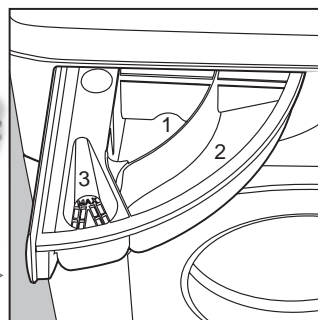



G On-off lamp / door locked
Lamp G flashes slowly when the appliance is switched on and awaiting instructions and at the end of a cycle, indicating that the door can be opened. It flashes quickly when the door should not be opened. A steady light means the appliance has accepted the selected programme.



The detergent dispenser is here.



What are you washing today? A programme for all seasons

Type of fabric and degree of soil	Program- me knob	Detergent for prewash	Detergent for wash	Fabric softener	Length of the cycle (minutes)	Description of wash cycle
COTTONS						
Exceptionally soiled whites (sheets, tablecloths, etc.)	1	◆	◆	◆	165	Prewash, wash cycle at 90°C, rinse cycles, intermediate and final spin cycles
Exceptionally soiled whites (sheets, tablecloths, etc.)	2		◆	◆	145	Wash cycle at 90°C, rinse cycles, intermediate and final spin cycles
Heavily soiled whites and fast colours	3		◆	◆	130	Wash cycle at 60°C, rinse cycles, intermediate and final spin cycles
Heavily soiled whites and fast colours	4		◆	◆	150	Wash cycle at 40°C, rinse cycles, intermediate and final spin cycles
Slightly soiled whites and delicate colours (shirts, jumpers, etc.)	5		◆	◆	95	Wash cycle at 40°C, rinse cycles, intermediate and final spin cycles
Rinse cycles				◆		Rinse cycles, intermediate and final spin cycles
Spin cycle						Draining and final spin cycle
Drying cycle for cotton fabrics						
Stop/Reset	●					Interrupts/Cancel the selected programme
SYNTHETICS						
Heavily soiled fast colour synthetics (baby linen, etc.)	6		◆	◆	100	Wash cycle at 60°C, rinse cycles, anti-crease or delicate spin cycle
Heavily soiled fast colour synthetics (baby linen, etc.)	7		◆	◆	95	Wash cycle at 50°C, rinse cycles, anti-crease or delicate spin cycle
Delicate colour synthetics (all types of slightly soiled garments)	8		◆	◆	70	Wash cycle at 40°C, rinse cycles, anti-crease or delicate spin cycle
Delicate colour synthetics (all types of slightly soiled garments)	9		◆	◆	30	Wash cycle at 30°C, rinse cycles and delicate spin cycle
Rinse cycles				◆		Rinse cycles, anti-crease or delicate spin cycle
Fabric softener				◆		Rinse cycles with automatic introduction of softener, anti-crease or delicate spin cycle
Spin cycle						Draining and delicate spin cycle
Drying cycle for synthetic fabrics						
Stop/Reset	●					Interrupts/Cancel the selected programme
WOOL						
Hand wash	10		◆	◆	45	Wash cycle at 40°C, rinse cycles and delicate spin cycle
Rinse cycles				◆		Rinse cycles and delicate spin cycle
Spin cycle						Draining and delicate spin cycle
Stop/Reset	●					Interrupts/Cancel the selected programme
SILK						
Particularly delicate garments and fabrics (curtains, silk, viscose, etc.)	11		◆	◆	50	Wash cycle at 30°C, rinse cycles, anti-crease or draining
Rinse cycles				◆		Rinse cycles, anti-crease or draining
Draining						Draining
Stop/Reset	●					Interrupts/Cancel the selected programme
PROGRAMMED START						
12 - 9 - 3 hour delay						Start is delayed by 12 - 9 - 3 hours
Stop/Reset	●					Interrupts/Cancel the selected programme

Important: to cancel the wash programme you have just set, select one of the symbols ● (Stop/Reset) and wait for at least 5".

The data found in the table is purely indicative, and can vary according to the quantity and type of washing, the water system temperature and the room temperature.

Special programmes

"A" wash performance Margherita has a special programme to allow you to obtain optimum results even at low temperatures. By setting programme **4** at a temperature of **40°C**, the results you will obtain will be the same as you would normally obtain at **60°C** thanks to the washer-dryer's action and the length of the wash cycle.

Daily wash Margherita has a programme studied for the washing of lightly soiled garments in a short amount of time. By setting programme **9** at a temperature of **30°C**, you can wash different types of fabrics together (except for wool and silk), with a maximum load of **3 kg**. This programme allows you to save on both time and energy as it only lasts around **30** minutes. We recommend the use of liquid detergent.

How to dry

A combined Washing and Drying Programme

Look at table A to the side and follow the instructions provided for **MAX** load to have an **automatic** washing and drying cycle.

Follow the instructions for **wash only** (see page 2, the paragraph entitled "Starting Margherita") and use knob **B** to set the type of drying cycle desired, then press button **F** (**ON** position).

If the laundry load to be washed and dried exceeds the maximum load foreseen (see table A), then follow the instructions provided for **wash only** (see page 2, the paragraph entitled "Starting Margherita").

When the wash cycle has finished, remove your washing, divide it up and replace part of it inside the drum.

Now follow the instructions provided for a **dry only** cycle. Repeat this procedure for the remainder of the load.

Dry only

Once you have loaded the washing that needs drying (2,5 kg max. for cottons, see table for other fabrics), make sure that:

- the door is shut correctly;
- the plug is inserted in the socket;
- the water tap is turned on;
- button **F** has not been pressed (**OFF** position).

And now set the wash cycle knob

Set knob **A** on the appropriate drying setting ☀ depending on the type of fabric, select the type of drying cycle required using knob **B** and then press on-off button **F** (**ON** position).

At the end of the drying cycle...

Wait for lamp **G** to flash slowly, then turn the washer-dryer off by pressing on-off button **F** (**OFF** position). Now you can open the appliance door. Once you have removed the washing from the appliance, leave the door open or ajar to avoid the formation of bad odours and turn off the water tap.

IMPORTANT

A spin cycle is carried out during the drying if you have set a **cotton programme** and a **level of dryness** (Extra dry ☐☐, Wardrobe ☐, Iron ☐).

A.

Fabric type	Load type	Max. load (kg)	Drying time (Min.)		
			Extra dry	Wardrobe	Iron
Cotton, Linen	Clothing of different sizes	2,5	150	145	140
Cotton	Terry towels	2,5	150	145	140
Terital, Cotton	Sheets, Shirts	2,5	100	90	85
Acrylics	Pyjamas, socks, etc.	1	65	60	60
Nylon	Slips, tights, stockings, etc.	1	65	60	60

The data contained in the table are purely indicative.

For cotton loads of less than 1 Kg, use the drying programme designed for synthetic fabrics.





WARNING

- During the drying phase, the door tends to get quite hot.
- Do not use the appliance to dry clothes that have been washed with flammable solvents (e.g. trichlorethylene).
- Do not use the appliance to dry foam rubber or similar elastomers.
- Make sure that the water tap is turned on during the drying cycles.
- This washer-dryer can only be used to dry clothes which have been pre-washed in water.

Understanding labels

Learn the meaning of these symbols and you will get better results, your garments will last longer and your machine will repay you by washing better.

All over Europe, garment labels contain messages expressed in small yet important symbols. Understanding them is very important if you want to get better results and treat your garments the way they deserve to be treated.

These symbols are divided in five different categories and shapes: washing , bleaching , ironing , dry cleaning  and drying .



Make sure you select the right temperature!

Useful tips



























Turn shirts inside out to get better results and make them last longer.

Always empty pockets of their contents.

Look at the label: it will always give you useful advice.

When loading your washing, alternate large and small garments.

Consult and learn the symbols in this table: they will help you obtain a better wash, treat your clothes properly, and get a better performance out of your Ariston Margherita.

Wash		Bleaching	Ironing	Dry cleaning	Drying	
<i>Strong action</i>	<i>Delicate action</i>				<i>High Temp.</i>	<i>Low Temperat.</i>
 Wash at 95°C	 Wash at 95°C	 Bleaching only in cold water	 Hot iron at max 200°C	 Dry clean with any solvent	 Machine dryable	 Machine dryable
 Wash at 60°C	 Wash at 60°C	 Do not bleach	 Medium hot ironing at max 150°C	 Dry clean only with perchloride, benzine av., pure alcohol, R111 and R113	 Do not machine dry	
 Wash at 40°C	 Wash at 40°C		 Iron at max 110°C	 Dry clean with av. benzine, pure alcohol and R113	 Spread to dry	
 Wash at 30°C	 Wash at 30°C		 Not ironable	 Do not dry clean	 Hang to dry without spin drying	
Hand wash					 Dry on clothes hanger	
Not washable in water						

Useful tips to avoid mistakes

■ **Never use your washer-dryer to wash...** torn, fraying or non-hemmed linen. If it is absolutely necessary, place it in a bag for protection. Brightly coloured linen with whites.

■ **Watch the weight!**

For best results, do not exceed the weight limits stated below (figures show weight when dry):

- *Resistant fabrics:*
5.5 kg maximum
- *Synthetic fabrics:*
2.5 kg maximum
- *Delicate fabrics:*
2 kg maximum
- *Pure new wool:*
1 kg maximum

■ **How much does it weigh?**

- 1 sheet 400-500 gr.
- 1 pillow case 150-200 gr.
- 1 tablecloth 400-500 gr.
- 1 bathrobe 900-1,200 gr.
- 1 towel 150-250 gr.

■ **Coloured T-shirts**, printed ones and shirts last longer if turned inside out before washing. Printed T-shirts and sweatshirts should always be ironed inside out.

■ **Salopette alert.**

Very popular "salopette" type overalls have straps with hooks that can damage the drum of your washer-dryer or other garments during the wash. By placing the hooks in the bib pocket and fastening them with safety pins, all risks are avoided.

■ **Holidays: unplug the appliance.**

When you go on holiday, we recommend that you unplug your washer-dryer, shutting off the water inlet tap and leaving the door opened or ajar. In this way, both the drum and the gasket will remain nice and dry and unpleasant odours will not develop inside the washer-dryer.

WOOL CYCLE

For best results, we recommend you use a specific detergent, taking care not to wash more than **1 kg** of laundry.

How to wash almost anything

■ **Curtains.**

Curtains tend to crease a great deal. Here is a tip to reduce creasing: fold the curtains and place them in a pillow case or mesh bag. Do not load anything else, so that the overall weight does not exceed the half load. Remember to use the specific programme **11** which automatically excludes the spin cycle.

■ **Quilted coats and wind-cheaters.**

You can wash quilted coats and wind-cheaters, too, if they are padded with goose or duck down. Do not load more than 2-3 kg and never load 5.5 kg. Repeat rinse once or twice using the gentle spin.

■ **Trainers.**

Once you have removed mud and dirt from trainers, you can wash them with jeans and other tough garments. Do not wash trainers with whites.

It's important for a good wash

The secrets of the detergent dispenser

The first secret is the easiest: the detergent dispenser is opened by rotating it outwards.

You must add detergent and any additives following the dosage recommended by the manufacturers: generally, all the indications you need are on the box. Doses vary according to wash load, the water hardness and how soiled the washing is. Experience will help you select the right dosage almost automatically: it will become your secret.

When pouring in the softener in compartment **3**, avoid making it overflow from the grate.

The washer-dryer automatically adds the softener to the wash in each programme.

Liquid detergent is to be poured into compartment **2** only a few seconds before starting the wash cycle.

Remember that liquid detergent is particularly indicated for wash cycles of up to 60 degrees on non pre-wash items.

Liquid or powder detergents are sold together with special containers that are to be placed directly inside the washer-dryer drum, according to the instructions found on the detergent box.

Never use hand wash detergent, because it may form too much foam, which could damage the washer-dryer.

Detergents that are specifically indicated for both hand and machine wash are an exception. One last secret: when washing with cold water, always reduce the amount of detergent you use: it dissolves less easily in cold water than in hot water, so part of it would be wasted.

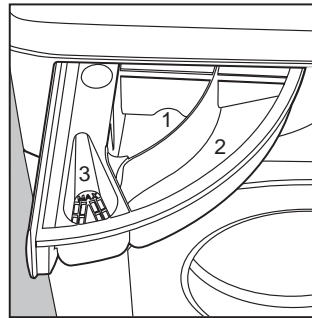

In compartment 1:
Detergent for pre-washing (powder)

In compartment 2:
Detergent for washing
(powder or liquid)

In compartment 3:
Additives (softeners, perfumes, etc.)

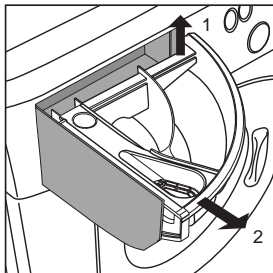

The detergent dispenser can be removed and cleaned: just lift it up and pull it outwards, as indicated in the figure. Then leave it under running water for a few minutes.

Cutting costs efficiently

MAXIMISE THE LOAD SIZE

Achieve the best use of energy, water, detergent and time by using the recommended maximum load size.

SAVE up to 50% energy by washing a full load instead of 2 half loads.

DO YOU NEED TO PRE-WASH?

For heavily soiled laundry only!

SAVE detergent, time, water and between 5 to 15% energy consumption by NOT selecting Prewash for slight to normally soiled laundry.

IS A HOT WASH REQUIRED?

Pretreat stains with stain remover or soak dried in stains in water before washing to reduce the necessity of a hot wash programme.

SAVE up to 50% energy by using a 60°C wash programme.

BEFORE USING A DRYING PROGRAMME ...

SAVE energy and time by selecting a high spin speed to reduce the water content in laundry before using a drying programme.

A guide to environmentally friendly and economic use of your appliance.

Before calling, read the following

Your washer-dryer could fail to work. In most cases, the problems arising can be easily solved without having to call for a technician. Before calling for assistance, always check these points.

The washer-dryer fails to start.

- **Is the plug correctly inserted into the socket?** It could have been moved whilst cleaning.
- **Is there electricity in the house?**
A circuit breaker could have gone off, perhaps because too many appliances are on at the same time. Or perhaps because of a general power failure in your entire area.
- **Is the washer-dryer door closed properly?**
For safety reasons, the washer-

dryer cannot work if the door is open or not shut properly.

- **Is the On/Off button pressed?**
If it is, then a programmed start has been set.
- **Is the programmed start knob, on those models concerned, in the correct position?**
- **Is the water tap open?** For safety reasons, if the washer-dryer does not load water, it cannot start a wash cycle.



RIGHT

WRONG

Close the tap after every wash cycle. Limit the use of the washer-dryer's hydraulic system and eliminate leakage risks when no-one is at home.

Always leave the appliance door ajar to avoid bad odours.

Clean the appliance's exteriors delicately. To clean the exteriors and the rubber parts of the appliance, always use a rag dipped in lukewarm water and soap.

Leave the washer-dryer plugged in while cleaning. Even during maintenance, the appliance should always be unplugged.

Use solvents and aggressive abrasives. Never use solvents or abrasives to clean the external and rubber parts of the washer-dryer.

Neglect the detergent dispenser. It is removable and can easily be cleaned by leaving it under running water.

Go on holiday without thinking about her. Before leaving, always make sure that the washer-dryer is unplugged and that the water tap is closed.

But where did all the water go?

Simple: with the new Ariston technology, you need less than half of it, to get good results on twice as much! This is why you cannot see the water through the door: because there is little, very little of it, to respect the environment yet without renouncing maximum cleanliness. And, on top of that, you are also saving electricity.



The programme selector knob keeps turning?

- **Wait a few minutes for the drain pump to empty the tub, switch Margherita off, select one of the symbols stop/reset ●, then switch it back on.** If the knob continues to turn, call for assistance because it is reporting an anomaly.



The washer-dryer fails to load water.

- **Is the tap correctly attached to the pipe?**
- **Is there a water shortage?** There could be work in progress in your building or street.
- **Is there enough pressure?** The autoclave may be malfunctioning.
- **Is the tap filter clean?** If the water is very calcareous, or if work has recently been carried out on the water piping, the tap filter could be clogged with particles and debris.
- **Is the rubber hose bent?** The tract of the rubber hose bringing water to the washer-dryer must be as straight as possible. Make sure it is not squashed or bent.



The washer-dryer continuously loads and unloads water.

- **Is the drain hose positioned too low?** It must be installed at a height ranging from 60 to 100 cm.
- **Is the hose's mouth immersed in water?**
- **Does the wall drainage system have a breather pipe?** If the problem persists even after these checks, close the water tap, switch the appliance off and call for assistance.
If you live on an upper floor of your building, there may be a problem with your drain trap. To solve this problem, a special valve must be installed.



The washer-dryer does not drain or spin.

- **Does the selected programme foresee water draining?** Some wash cycles require enabling the draining manually.
- **Is the "Rinse hold" function -where provided - enabled?** This function require enabling the draining manually.
- **Is the drain pump clogged?** To check it, close the tap, unplug the washer-dryer and follow the instructions on page 13, or call for technical assistance.

■ **Is the drain hose bent?** The tract of the drain hose must be as straight as possible. Make sure it is not squashed or bent.

■ **Is the washer-dryer's drain duct clogged?** Is there an extension of the drain hose? If so, is it positioned incorrectly, blocking the water flow?



The washer-dryer vibrates too much during the spin cycle.

- **Has the internal floating unit been correctly unblocked during installation?** See the following page on installation procedures.
- **Has the washer-dryer been levelled correctly?** The levelling of the appliance should be checked periodically. In time, the machine could move imperceptibly. Adjust the feet and check them with a level.

■ **Is the appliance closed in between furniture and a wall?** If it is not a built-in model, the washer-dryer needs to oscillate a bit during the spin cycle. A few cm of space should therefore be left around it.



The washer-dryer leaks.

- **Is the metal ring of the inlet hose properly attached?** Close the tap, unplug the appliance and try tightening its attachment without forcing it.
- **Is the detergent dispenser obstructed?** Try extracting it and washing it under tap water.
- **Is the drain hose well attached?** Close the tap, unplug the appliance and try tightening its attachment.



Too much foam.

- **Is the detergent appropriate for machine washing?** Check whether its label reads the definition "for machine wash" or "hand and machine wash", or other similar indications.
- **Is the correct amount being used?** An excessive amount of detergent, besides producing too much foam, does not guarantee a more effective wash, and causes scaling in the internal parts of the appliance.

The washer-dryer does not dry.

- **Check whether:** the plug has been correctly inserted into the socket; there is electricity in your home; the appliance door has been shut properly; a delayed start (if available) has not been selected; programme knob **A** has been set to position ● (Stop/Reset); the drying cycle knob **B** has been set to position 0.

The washer-dryer doesn't dry properly.

- **Check whether:** the end of the drain hose is underwater; the drain pump is obstructed; the advice given on the maximum loads has been taken; the water tap has been turned on.

If, despite all checks, the washer-dryer fails to function and the problem persists, call your nearest authorised Customer Service Centre, providing the following information:

- the type of malfunctioning
- the model type no. (Mod.)
- the serial number (S/N)

These indications can be found on the data plate situated on the back of the washer-dryer.

Always get assistance from authorised technicians and always insist on original spare parts.

Technical characteristics

Model	ALD 10
Dimensions	width 59,5 cm height 85 cm depth 53,5 cm
Capacity	from 1 to 5,5 kg for the wash programme; from 1 to 2,5 kg for the drying programme
Electrical connections	voltage 230/240 Volt 50 Hz maximum absorbed power 1850 W
Water connections	maximum pressure 1 MPa (10 bar) minimum pressure 0,05 MPa (0,5 bar) drum capacity 46 litre
Spinning speed	up to 1000 rpm
Control programs in compliance with IEC regulation 456	wash: programme 3; temperature 60°C. Carried out with 5 kg load. drying: run with a load of 2.5 kg and knob B set to position .
	This appliance conforms with the following E.E.C. directives: - 73/23/EEC of 19/02/73 (Low Voltage) and subsequent modifications - 89/336/EEC of 03/05/89 (Electromagnetic Compatibility) and subsequent modifications

When Margherita arrives



Whether new or just transported to a new house, installation is extremely important for the correct functioning of your washer-dryer.

After removing the appliance from its packaging, check that it is intact. If in doubt, contact a qualified technician immediately. **The inside of the machine is supported, for transportation, by four screws on the back panel.**

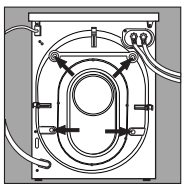

Before using the washer-dryer, **remove the screws**, remove the spacers together with the rubber tubes attached to them (keeping all the parts) and use the plastic plugs provided to fill in the holes.

Important: Use the cap (provided) to close the 3 holes which housed the stop pin, situated in the right-hand part of the lower back of the washer-dryer.

Levelling

The washer-dryer must be levelled appropriately in order to guarantee its correct functioning. To level the appliance, the front feet must be adjusted; the angle of inclination, measured according to the worktop, must not exceed 2°. When placed on carpet, make sure the ventilation is not reduced.

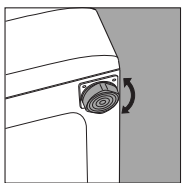

The front feet are adjustable.

Retain the transit screws, spacers and washers. Should you move house then these should be replaced to support the inside of the machine to prevent damage when transporting the machine.

Connection to the water mains

Both hot and cold water supplies are preferable and they should be between 34.5kN/m² (5lb/in²) and 1034.2kN/m² (150lb/in²) pressure. The hose having the **red** end fitting should be encountered between the **hot** supply and the threaded connection adjacent to the letter **H** on the rear of the machine. The hose having the **white** end fittings should be connected between the **cold** supply and the threaded connection adjacent to the letter **C** on the rear of the machine. Remember to insert a sealing washer-dryer at each connection to ensure watertight joints. **Do not overtighten** the connections by using tools - hand tight is sufficient to prevent leaks. It is generally more convenient to have these supplies away from the sink taps. Where no suitable hot water supply is available or it does not meet these requirements, both inlet hoses may be connected to a cold supply by using two taps etc., or a «T» junction on the plumbing however, use of cold water only will increase programme times. **Note:** the maximum temperature should not exceed 70°C (158°F).

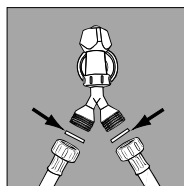

The rubber gasket.

Connect the inlet hose to the threaded connector on the machine rear.

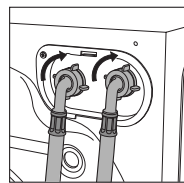

Water pipe inlet at the top right.

Connecting the drain hose

The drain hose (hooked pipe) is secured to the rear of the machine by support clips and may be routed to right or left as required.

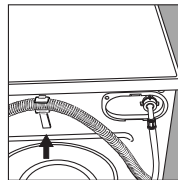

The hook to be used in case the drain hose ends at a height below 60 cm.

The drain hose should be placed in a stand pipe with a minimum internal diameter of 38 mm (1½ inches) or it can be positioned over a sink or it can be connected as shown in Fig. A. The height of stand pipe or sink should be between 60 and 100 cm (24 and 40 inches). Care must be taken that the hose is not obstructed, twisted, submerged or kinked. If the hose is connected with an airtight joining, provision should be made to prevent syphoning.

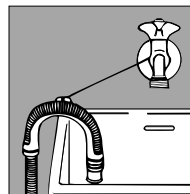

The guide for draining into tubs and sinks.

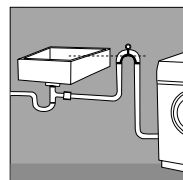

Fig. A

Electric connection

Your appliance is now supplied with a 13 amp fused plug it can be plugged into a 13 amp socket for immediate use. Before using the appliance please read the instructions below.

WARNING - THIS APPLIANCE MUST BE EARTHED. THE FOLLOWING OPERATIONS SHOULD BE CARRIED OUT BY A QUALIFIED ELECTRICIAN.

Replacing the fuse:

When replacing a faulty fuse, a 13 amp ASTA approved fuse to BS 1362 should always be used, and the fuse cover re-fitted. If the fuse cover is lost, the plug must not be used until a replacement is obtained.

Warning!
The company denies all liability if and when these norms are not respected.

Plastic bags, expanded styrofoam, nails and other packaging parts are not children's toys, and are potentially dangerous.

Replacement fuse covers:

If a replacement fuse cover is fitted, it must be of the correct colour as indicated by the coloured marking or the colour that is embossed in words on the base of the plug. Replacements can be obtained directly from your nearest Service Depot.

Removing the plug:

If your appliance has a non-rewireable moulded plug and you should wish to re-route the mains cable through partitions, units etc., please ensure that either: the plug is replaced by a fused 13 ampere re-wearable plug bearing the BSI mark of approval. or: the mains cable is wired directly into a 13 amp cable outlet, controlled by a switch, (in compliance with BS 5733) which is accessible without moving the appliance.

Disposing of the plug:

Ensure that before disposing of the plug itself, you make the pins unusable so that it cannot be accidentally inserted into a socket.

Instructions for connecting cable to an alternative plug:

Important: the wires in the mains lead are coloured in accordance with the following code:

Green & Yellow **Earth**
 Blue **Neutral**
 Brown **Live**

As the colours of the wires in the lead may not correspond with the coloured markings identifying the terminals in your plug, proceed as follows:

Connect Green & Yellow wire to terminal marked **E** or \perp or coloured Green or Green & Yellow.

Connect Brown wire to terminal marked **L** or coloured Red.

Connect Blue wire to terminal marked **N** or coloured Black.

If a 13 amp plug (BS 1363) is used it must be fitted with a 13 amp fuse, either in the plug or adaptor or at the distribution board.

If you are in any doubt the electrical supply to your machine, consult a qualified electrician before use.

How to connect an alternative plug:

The wires in this mains lead are coloured in accordance with the following code:

BLUE **NEUTRAL (N)**
 BROWN **LIVE (L)**
 GREEN & YELLOW **EARTH (E)**

Disposing of the appliance:

When disposing of the appliance please remove the plug by cutting the mains cable as close as possible to the plug body and dispose of it as described above.

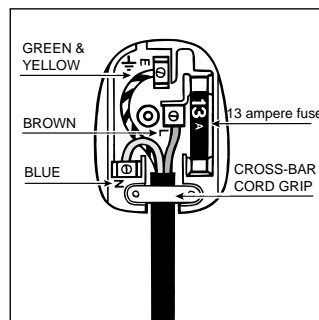

Treat her well and she'll be your friend forever

Your washer-dryer is a reliable companion in life and on the job. It is just as important for you to keep it in shape.

Margherita is a washer-dryer designed to last a lifetime without any problems. A few simple steps help keep it in shape and last longer. Firstly, you must close the water tap after each wash: the constant pressure of water could warp a few of the component parts.

In addition, by doing so, you will avoid the risk of leaks when no-one is at home.

If the water in your area is too hard, use a deliming product (water is hard if it often leaves whitish stains around taps or drains, especially of bath tubs).

For more accurate information as to the type of water in your system, call the local water works or a local plumber).

Pockets must always be emptied removing even pins, badges and any other hard object.

The washer-dryer exterior should be cleaned with a rag dipped in lukewarm water and soap.

It is important to wash the detergent dispenser regularly.

To prevent dried washing powder from accumulating, place the dispenser under running water for a few minutes.

Never exaggerate with doses.

Normal detergents already contain deliming agents. Only if the water is particularly hard, that is, rich in lime content, do we recommend the use of a specific product at every wash. A periodical wash cycle with a dose of a deliming product, without detergents or washing, may prove useful.

Never use too much detergent or additives because this could cause an excess amount of foam, scaling and possible damage to the component parts of your washer-dryer.



Do not forget to empty all pockets: small objects can cause damage to your friend Margherita.

When in need, check the pump and the rubber hose.

Margherita comes equipped with a self-cleaning pump that does not require any cleaning or maintenance. Small objects may accidentally fall into the pump: coins, hair clips, loose buttons and other small items. To avoid possible damage, they are withheld in an accessible pre-chamber, situated at the lower end of the pump.

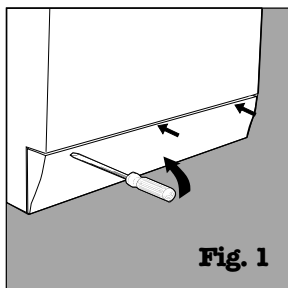

To access this pre-chamber, just remove the panel covering the bottom of the washer-dryer using a screwdriver (figure 1); then lift the cover rotating it anti-clockwise (figure 2) and check its contents accurately.

The rubber hose

Check the rubber hose at least once a year. If you see any cracks, replace it immediately. When you use your washer-dryer, water pressure is very strong and a cracked tube could easily split open.

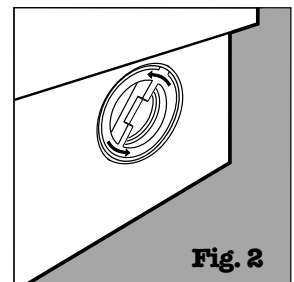

Attention: make sure that the wash cycle has come to a full stop and unplug the appliance before removing the lid as well as before any type of maintenance procedure. It is normal to find that a little water comes out after removing the lid. When replacing the panel, make sure you insert the hooks situated at the bottom of the washer-dryer in the right slots before pushing it back against the appliance.

More and more important

Your safety and that of your children

Margherita has been built in compliance with the strictest international safety regulations. To protect you and all your family.

Read these indications and all the information in this manual carefully: they are an important source, not only of numerous useful tips, but also of vital information on safety, use and maintenance.

- 1. Margherita should not be installed in an outdoor environment**, not even when a roof shelters the area, because it may be very dangerous to leave it exposed to rain and thunderstorms.
- 2. It must only be used by adults** and exclusively for washig clothes following the instructions provided in this manual.
- Should it have to be moved, proceed with the help of two or three people and handle it with the utmost care. Never try to do this alone, because **the appliance is very heavy**.
- Before loading the washer-dryer, **make sure the drum is empty**.
- 5. Never touch the washer-dryer when barefoot or with wet or damp hands or feet.**
- 6. Never use extensions or multiple plugs**, which are particularly dangerous in humid environments. The power supply cable must never be bent or dangerously compressed.
- 7. Never open the detergent dispenser while the appliance is functioning; do not use hand wash detergent** because the abundance of foam could damage its internal parts.
- 8. Never pull on the plug** or the washer-dryer to disconnect it from the wall socket: it is extremely dangerous.
- While the appliance is functioning, **do not touch the drain water** as it could reach very high temperatures. **The appliance door, during wash cycles, tends to become heated**; keep it out of children's reach. **Never force the washer-dryer door** because this could damage the safety block on the opening, which serves to protect from accidental openings.
- 10. In case of malfunctioning, first close the water tap and unplug the appliance from the wall socket**; do not under any circumstances touch internal parts in order to attempt repairs.

I only want an authorised specialised technician with original Ariston spare parts!

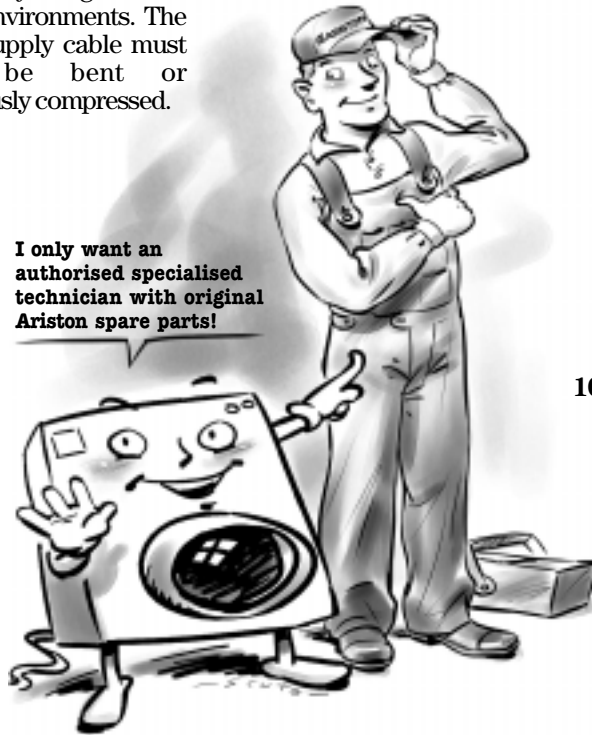

How to change the power supply cable

(For this operation we suggest you contact a qualified engineer)

The Margherita power supply cable is special and can be purchased exclusively from authorised Technical Service Centres.

To replace the cable:

1. Make sure that Margherita is switched off and unplugged.

2. Remove the covering lid by unscrewing the two screws **I**, and then pull it towards you [fig. 3].

3. Disconnect the wires from the radio interference suppressor **F** [fig. 4] noting as to their position (**Blue=N** wire; **Brown=L** wire) leaving the earth wire until last \perp .

M.B.: letters **L**, **N** and the symbol \perp are indicated on the radio interference suppressor.

4. Remove the upper part of the cable slightly from the back panel of the appliance, pull the power supply cable upwards and take it out [fig. 5].

To connect the new power supply cable, reverse the procedure.

To put the covering lid back on, rest it on the washer-dryer [fig. 6] and let it slide forwards until the hooks situated on the front slide into the special slots formed into the control panel and tighten the screws back on.

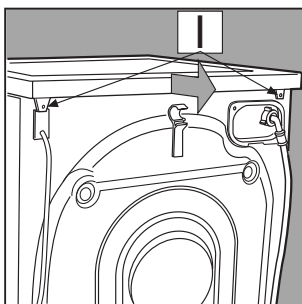

Fig. 3

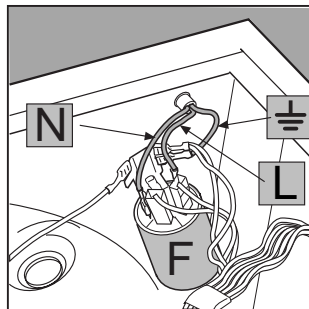

Fig. 4

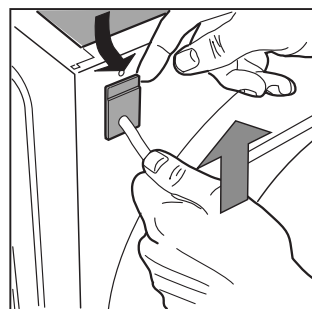

Fig. 5

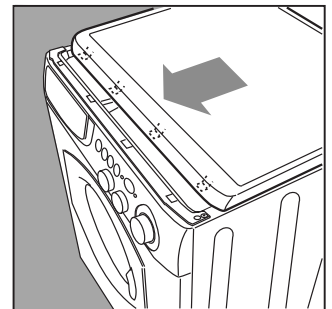

Fig. 6

Stay in touch



THANK YOU for choosing an **Ariston appliance**. We are confident you have made a **good choice** and that your new appliance will give **many years of excellent service**.

And we're **there when you need us**.

Register your purchase now

This will confirm your entitlement to **free spare parts for five years**, and you could also be lucky enough to recover the cost of your purchase in our **quarterly prize draw**.

Simply complete and return the **Registration Form** supplied with the appliance documents, using the **FREEPOST envelope** supplied. Or call the **Registration Hotline** on **0870 010 4305**.

Enjoy **complete peace of mind**. By registering now, you automatically qualify for a **full year's guarantee** on parts and labour **PLUS** free functional **parts cover for a further 4 years**, provided they are genuine Ariston spare parts fitted by an Ariston Service Engineer.

We're as close to you as your telephone

For direct access to **Genuine Ariston Spare Parts and Accessories**, call **0870 558 5850** and speak to our skilled staff who can help you to identify and purchase the item you require.

For a **Rapid Response** to a **problem with your appliance**, call **0870 607 0805**. We're open from Monday to Saturday (8am - 5.30pm weekdays, 9am - 5pm Saturday). We have our own department of highly trained Ariston service staff. For most calls, our Service Engineer can fix the problem on the first visit.

Please have the following details to hand when you ring us:

The **nature** of the problem, the **Model Number** and the **Serial Number**.

These numbers can be found on the appliance and on the portion of the Registration Card which you retain.

Merloni Elettrodomestici spa

Via Aristide Merloni, 47 - 60044 Fabriano - tel. (0732) 6611 - Italy