

MULTI
FUNCTION
FAX
PHONE

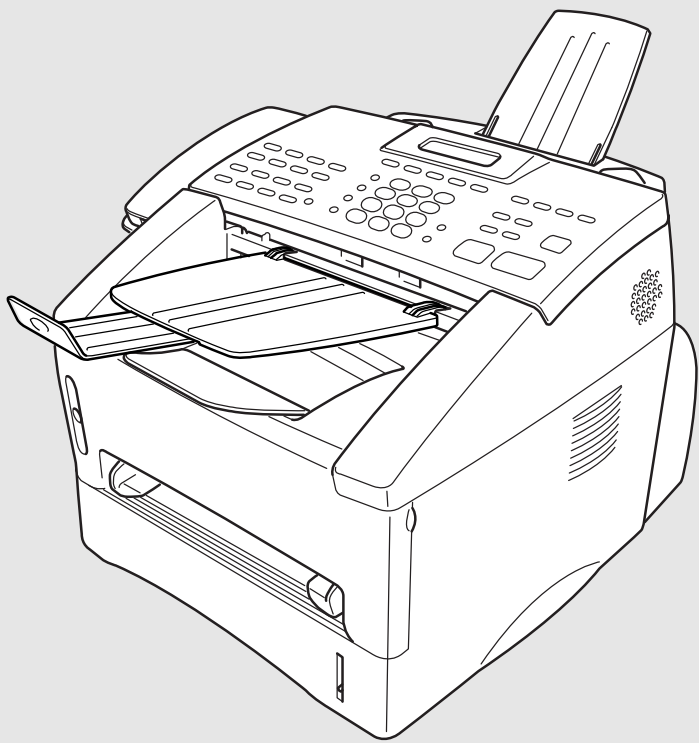

FAX-4750e

FAX-5750e

brother

version C

If You Need to Call Customer Service

Please complete the following information for future reference:

Model Number: FAX-4750e, FAX-5750e

(Circle your model number)

Serial Number*: _____

Date of Purchase: _____

Place of Purchase: _____

* The serial number is on the back of the unit. Retain this manual with your *sales receipt* as a permanent record of your purchase, in the event of theft, fire or warranty service.

Brother Numbers

IMPORTANT

For technical and operational assistance, you must call the country where you purchased the machine. Calls must be made *from within* that country.

Brother fax-back system (USA Only)

Brother Customer Service has installed an easy-to-use fax-back system, so you can get instant answers to common technical questions and product information for all Brother products. This system is available 24 hours a day, 7 days a week. You can use the system to send faxes to any fax machine.

If you can't resolve a difficulty with your Brother machine using this manual, call our fax-back system, and follow the voice prompts to receive faxed instructions about using the system and an index of fax-back subjects.

In USA Only: 1-800-521-2846

The Brother fax-back system number has been preprogrammed on One Touch key **01**.

Frequently Asked Questions (FAQs)

The Brother Solutions Center is our one-stop resource for all your Fax Machine/Multi-Function Center needs. You can download the latest software and utilities, read FAQs and troubleshooting tips, and go to the "Solutions" section to learn how to get the most from your Brother product.

<http://solutions.brother.com>



You can check here for Brother Printer Driver updates.

For Customer Service

In USA: 1-800-284-4329 (voice)
1-908-575-8790 (fax)
1-800-284-3238 (TTY service for the hearing-impaired)

In Canada: 1-877-BROTHER (voice)
(514) 685-4898 (fax)
(514) 685-6464 (voice) **(In Montreal)**

Dealers/Service Centers (USA Only)

For the name of a Brother authorized dealer or service center, call 1-800-284-4357.

Service Centers (Canada Only)

For service center addresses in Canada, call 1-877-BROTHER.

Ordering Accessories and Supplies

IMPORTANT

For technical and operational assistance, you must call the country where you purchased the machine. Calls must be made *from within* that country.

For best quality results use only genuine Brother accessories, available at most Brother retailers. If you cannot find the accessory you need and you have a Visa, MasterCard, Discover or American Express credit card, you can order accessories directly from Brother. (In the USA, you can visit us online for a complete selection of Brother accessories and supplies available for purchase.)

In USA: 1-888-879-3232 (voice)
1-800-947-1445 (fax)
<http://www.brothermall.com>

In Canada: 1-877-BROTHER (voice)

Description	Item
Laser Fax Toner	TN-430 (Able to print 3000 pages) TN-460 (Able to print 6000 pages)
Laser Fax Drum	DR400
16 MB Expandable Memory Board (Option for FAX-4750e and 5750e)	<i>See chapter Optional Accessories</i>
32 MB Expandable Memory Board (Option for FAX-4750e and 5750e)	<i>See chapter Optional Accessories</i>
Telephone Line Cord	LG3077001
Telephone Handset	UF6857010
Handset Curled Cord	UF7204008
Document Tray and Extension	UU2069008
Document Support	UU2080008
Paper Cassette #2 (Option for FAX-4750e)	LT400
Power Protector for A/C Power and Phone Line Surges and Voltage Spikes (2 Outlets)	QPD120
Power Protector for A/C Power and Phone Line Surges and Voltage Spikes (8 Outlets)	FX 120
Network (LAN) Board Brother Print/Fax Server (10/100 BaseTX Ethernet Network) (Optional for FAX-4750e. Standard for FAX-5750e.)	NC-8100h
Owner's Manual	LE8118001
Printer Cable-Bi-Directional (10 feet) Parallel Cable with Gold Plated Contacts and IEEE-1284 Approved	F2A046-10
*MFL-Pro software on CD-ROM (Not available for FAX-4750e)	LE8158001 (For CD-ROM Drive)

Notice – Disclaimer of Warranties (For USA and Canada)

BROTHER'S LICENSOR(S), AND THEIR DIRECTORS, OFFICERS, EMPLOYEES OR AGENTS (COLLECTIVELY BROTHER'S LICENSOR) MAKE NO WARRANTIES, EXPRESS OR IMPLIED, INCLUDING WITHOUT LIMITATION THE IMPLIED WARRANTIES OF MERCHANTABILITY AND FITNESS FOR A PARTICULAR PURPOSE, REGARDING THE SOFTWARE. BROTHER'S LICENSOR(S) DOES NOT WARRANT, GUARANTEE OR MAKE ANY REPRESENTATIONS REGARDING THE USE OR THE RESULTS OF THE USE OF THE SOFTWARE IN TERMS OF ITS CORRECTNESS, ACCURACY, RELIABILITY, CURRENTNESS OR OTHERWISE. THE ENTIRE RISK AS TO THE RESULTS AND PERFORMANCE OF THE SOFTWARE IS ASSUMED BY YOU. THE EXCLUSION OF IMPLIED WARRANTIES IS NOT PERMITTED BY SOME STATES IN THE USA AND SOME PROVINCES IN CANADA. THE ABOVE EXCLUSION MAY NOT APPLY TO YOU.

IN NO EVENT WILL BROTHER'S LICENSOR(S) BE LIABLE TO YOU FOR ANY CONSEQUENTIAL, INCIDENTAL OR INDIRECT DAMAGES (INCLUDING DAMAGES FOR LOSS OF BUSINESS PROFITS, BUSINESS INTERRUPTION, LOSS OF BUSINESS INFORMATION, AND THE LIKE) ARISING OUT OF THE USE OR INABILITY TO USE THE SOFTWARE EVEN IF BROTHER'S LICENSOR HAS BEEN ADVISED OF THE POSSIBILITY OF SUCH DAMAGES. BECAUSE SOME STATES IN THE USA AND SOME PROVINCES IN CANADA DO NOT ALLOW THE EXCLUSION OR LIMITATION OF LIABILITY FOR CONSEQUENTIAL OR INCIDENTAL DAMAGES, THE ABOVE LIMITATIONS MAY NOT APPLY TO YOU. IN ANY EVENT BROTHER'S LICENSOR'S LIABILITY TO YOU FOR ACTUAL DAMAGES FROM ANY CAUSE WHATSOEVER, AND REGARDLESS OF THE FORM OF THE ACTION (WHETHER IN CONTRACT, TORT (INCLUDING NEGLIGENCE), PRODUCT LIABILITY OR OTHERWISE), WILL BE LIMITED TO \$50.

Compilation and Publication Notice

Under the supervision of Brother Industries Ltd., this manual has been compiled and published, covering the latest product descriptions and specifications.

The contents of this manual and the specifications of this product are subject to change without notice.

Brother reserves the right to make changes without notice in the specifications and materials contained herein and shall not be responsible for any damages (including consequential) caused by reliance on the materials presented, including but not limited to typographical and other errors relating to the publication.

Disclaimer–User Installation of Memory Board(s)

In some cases, product may be modified by adding and/or replacing the memory board(s) with approved replacements. Any damage to the product, the memory board(s) to be inserted therein or otherwise, caused as a result of improper installation (including installation of other than approved memory boards(s)) is not covered by the Limited Warranty. If you do not feel comfortable with the installation of approved memory board(s), contact a Brother Authorized Service Center to perform the installation of the memory board(s) for you. If you elect to use a Brother Authorized Service Center, you will be responsible for a moderate service charge. For the name and location of a convenient Authorized Service Center, please call 1-800-521-2846.

BROTHER ONE YEAR LIMITED WARRANTY and EXCHANGE SERVICE (For USA Only)

This warranty gives you certain rights and you may also have other rights that may vary from state to state.

This warranty is given only to the first end-user purchaser of the accompanying product (referred to in this warranty as "this Product").

What is covered: Brother warrants to you for the Warranty Period that there are no defects in the materials, workmanship or Year 2000 compliance of this Product. The "Warranty Period" is 1 year from the date you purchased this product. The "Warranty Period" for consumable items, such as Print Heads, Toner, Drums, Ink Cartridges, Print Cartridges, Refill Ribbons, Thermo PLUS Paper and Thermal Paper, etc. is 90 days from the date of purchase, or the rated life of the Consumable item, whichever is shorter.

What is NOT covered: Warranty WILL BE VOID by Brother for repairs or replacements made necessary due to the following: (1) If the Product was not purchased from an authorized Brother reseller within the United States, (2) The Product has been serviced or modified by anyone other than an Authorized Service Representative of Brother, (3) The serial number has been modified, defaced or removed from this Product, (4) Non-Brother®-brand or non-Brother approved parts, supplies, power supplies or other accessories have been used with this Product, (5) Any damage caused by accident, neglect, abuse or misuse or, the recommended monthly volume has been exceeded, (6) Damages caused as a result of modification, alteration or repairs performed by anyone other than a Brother Authorized Service Representative. (7) NOT COVERED UNDER WARRANTY ARE: Consumable items, for example (including, but not limited to): ribbons, ink or toner cartridges, toner drum units, print heads, cleaning and/or instances where no defects in material or workmanship are found in the Product, etc. (8) Damage caused by improper connection and/or disconnection of the Product; failure of the operator to follow operational instructions, improper set up of the Product.

What to do if you think your Product is defective:

Call our Customer Service Hotline at 1-800-284-4329, or if you suspect a defect in materials or workmanship in this Product, you can report it to a Brother Authorized Service Center. During the Warranty Period, supply

Brother's representative with a copy of your dated bill of sale showing that this Product was purchased within the United States.

For the name of your Brother Authorized Service Center, call 1-800-521-2846. After contacting the Brother Authorized Service Center, you may be required to deliver or send the Product properly packaged, freight prepaid, to the Authorized Service Center together with a photocopy of your bill of sale.

What Brother will do: Brother (or its Authorized Service Center) will evaluate your report of a possible defect to determine whether a defect exists, and if it does exist, Brother (or its Authorized Service Center) will repair or (at Brother's option) replace the Product with a product that performs the same functions and performs as well as the original Product. Brother reserves the right to supply refurbished or remanufactured replacement parts provided that the replacement parts conform to the manufacturer's specifications for new products. The repaired or replacement product will be returned to you at no cost.

Exchange Service:

When an exchange is authorized, Brother will exchange of your non working Product with a refurbished or remanufactured product that conforms to the manufacturer's specifications for new products. The refurbished or remanufactured Product you receive will be covered by the balance of the limited warranty period remaining on the original Product, plus an additional thirty (30) days. You will keep the replacement Product that is sent to you and must return (or be billed up to the cost of a new product) your original non working product, which shall become the property of Brother. You must call Brother Customer Service and if the representative cannot correct the product's malfunction over the telephone and you elect the exchange service, you must provide information pertaining to this Product and you must also provide a valid major credit card number. Your credit card will be charged up to the cost of a new Product if: (i) you do not return your original Product to Brother within five (5) business days; (ii) the malfunctions of your original Product are not covered by the limited warranty; (iii) the proper packaging instructions are not followed and has caused damage to the product; or (iv) the warranty period on your original Product has expired or has not been sufficiently validated with a copy of the proof of purchase (bill of sale).

BROTHER ONE YEAR LIMITED WARRANTY and EXCHANGE SERVICE (For USA Only)

The Brother Customer Service Representative will ship the exchange Product via next business day delivery courier service, with return instructions and prepaid return air bill.

Follow the return instructions. You must return the original Product in the same shipping carton in which the exchanged Product was received and include a copy of proof of purchase (bill of sale). Retain your original accessory items and a copy of the return air bill, signed by the courier.

Limitations:

Repair or replacement as described above is your sole and exclusive (that is, your only) remedy if this Product is defective. Brother is not responsible for damage to or loss of any equipment, media, programs or data related to the use of this Product. Except for that repair or replacement, *Brother shall not be liable for any direct, indirect, incidental or consequential damages or specific relief. Because some states do not allow the exclusion or limitation of consequential or incidental damages, the above limitation may not apply to you.*

THIS WARRANTY IS GIVEN IN LIEU OF ALL OTHER WARRANTIES, WRITTEN OR ORAL, WHETHER EXPRESSED BY AFFIRMATION, PROMISE, DESCRIPTION, DRAWING, MODEL OR SAMPLE. ANY AND ALL WARRANTIES OTHER THAN THIS ONE, WHETHER EXPRESS OR IMPLIED, INCLUDING IMPLIED WARRANTIES OF MERCHANTABILITY AND FITNESS FOR A PARTICULAR PURPOSE, ARE HEREBY DISCLAIMED.

This Limited Warranty is the only warranty that Brother is giving for this Product. It is the *final expression and the exclusive and only statement* of Brother's obligations to you. It replaces all other agreements and understandings that you may have with Brother or its representatives.

This Limited Warranty (and Brother's obligation to you) may not be changed in any way unless you and Brother sign the same piece of paper in which we (1) refer to this Product and your bill of sale date, (2) describe the change to this warranty and (3) agree to make that change.

Product Support: Toll-free Customer Service and technical support is available for hardware operational assistance at 1-800-284-4329. At any time, free technical support in the form of Frequently Asked Questions, troubleshooting tips and service center locator is available through our fax back system at 1-800-521-2846 or Brother's Internet Web Site (www.brother.com). Now you can visit us on-line (www.brothermall.com), your complete source for genuine Brother Accessories and Supplies.

BROTHER INTERNATIONAL CORPORATION

100 SOMERSET CORPORATE BLVD.

BRIDGEWATER, NEW JERSEY 08807-0911

Please record your model and serial number and your date and location of Purchase below for your records. Keep this information with your proof of purchase (bill of sale) in case your Product is lost, stolen or requires service.

Model # _____

Serial # _____

Date of purchase: _____

Store where purchased: _____

Location of store: _____

Important: *We recommend that you keep all original packing materials, in the event that you ship this product.*

**BROTHER MULTIFUNCTION CENTER/FACSIMILE MACHINE
LIMITED WARRANTY
(For Canada Only)**

Pursuant to this limited warranty of 1 year from the date of purchase for labour and parts, Brother International Corporation (Canada) Ltd. ("Brother"), or its Authorized Service Centers, will repair this MFC/Facsimile machine free of charge if defective in material or workmanship. This Limited Warranty does not include cleaning, consumables (including, without limitation, print cartridges, print head, toner and drum) or damage caused by accident, neglect, misuse or improper installation or operation, any damage caused from service, maintenance, modifications, or tampering by anyone other than a Brother Authorized Service Representative, or from the use of supplies or consumable items that are non-Brother products. Operation of the MFC/Facsimile machine in excess of the specifications or with the Serial Number or Rating Label removed shall be deemed abuse and all repairs thereafter shall be the sole liability of the end-user/purchaser. In order to obtain warranty service, the MFC/Facsimile machine must be delivered or shipped freight prepaid by the end user/purchaser to a "Brother" Authorized Service Center, together with your Proof of Purchase in the form of a Sales Receipt.

For laser products: Failure to remove the Toner Cartridge (and Toner Drum Unit on applicable models) during shipping will cause severe damage to the MFC/Facsimile and will VOID the Warranty. (Refer to your Operation Manual for proper packaging.)

For ink-jet products: Do not remove the ink cartridges during shipping. Damage to your print head resulting from packing without the ink cartridges will VOID your warranty. (Refer to your Operation Manual for proper packaging.)

BROTHER DISCLAIMS ALL OTHER WARRANTIES EXPRESSED OR IMPLIED INCLUDING, WITHOUT LIMITATION, ANY IMPLIED WARRANTIES OF MERCHANTABILITY OR FITNESS FOR A PARTICULAR PURPOSE, EXCEPT TO THE EXTENT THAT ANY WARRANTIES IMPLIED BY LAW CANNOT BE VALIDLY WAIVED.

No oral or written information, advice or representation provided by Brother, its Authorized Service Centers, Distributors, Dealers, Agents or employees, shall create another warranty or modify this warranty. This warranty states Brother's entire liability and your exclusive remedy against Brother for any failure of the MFC/Facsimile machine to operate properly.

Neither Brother nor anyone else involved in the development, production, or delivery of this MFC/Facsimile machine shall be liable for any indirect, incidental, special, consequential, exemplary, or punitive damages, including lost profits, arising from the use of or inability to use the product, even if advised by the end user/purchaser of the possibility of such damages. Since some Provinces do not allow the above limitation of liability, such limitation may not apply to you.

This Limited Warranty gives you specific legal rights and you may also have other rights which vary from Province to Province.

Warranty Service is available at Brother Authorized Service Centers throughout Canada. For Technical Support or for the name and location of your nearest Authorized Service Center call 1-877-BROTHER. Within Montreal, please call (514) 685-6464. Internet support: support@brother.ca or browse Brother's Web Site: www.brother.com

Brother International Corporation (Canada) Ltd.
1 Rue Hôtel de Ville
Dollard-Des-Ormeaux, QC H9B 3H6

At your side.
brother®





Quick Reference Guide

Sending Faxes

Automatic Transmission





- 1 Place the original face down in the ADF.
- 2 Enter the fax number using One Touch, Speed Dial, Search or the dial pad.
- 3 Press **Fax Start**.



Sending a Cover Page

- 1 Place the original face down in the ADF.
- 2 Press **Menu, 2, 2, 8**.
- 3 When **NEXT FAX ONLY** appears, press **Set**.
- 4 Press  or  to select **ON** (or **OFF**), and then press **Set**.
- 5 Press  or  to select a comment, and then press **Set**.
- 6 Enter two digits to indicate the number of pages being sent, and then press **Set**.
- 7 Press **1** to select additional settings —**OR**—Press **2** if you are ready to fax.
- 8 Enter the fax number.
- 9 Press **Fax Start**.

Real Time Transmission

You can send faxes in real time.

- 1 Place the original face down in the ADF.
- 2 Press **Menu, 2, 2, 6**.
- 3 Press  or  to select **ON**, and then press **Set**—**OR**—For the next transmission only press  or  to select **NEXT FAX ONLY**, and then press **Set**.

- 4 For the next fax only, press  or  to select **ON**, and then press **Set**.
- 5 Press **1** to select additional settings —**OR**—Press **2** to fax.
- 6 Enter the fax number.
- 7 Press **Fax Start**.

Receiving Faxes

Select Receive Mode

There are three Receive modes: **FAX**, **TAD**, and **FAX/TEL**. Press **Mode** until the LCD shows your selection. After two seconds the LCD returns to the Data and Time prompt and shows the new mode.

Brother fax-back system:

In USA: 1-800-521-2846

Brother Global Web Site:

<http://www.brother.com>

Frequently Asked Questions (FAQs) and Product Support:

<http://solutions.brother.com>

Brother Accessories & Supplies:

In USA:

1-888-879-3232 (voice)

1-800-947-1445 (fax)

<http://www.brothermall.com>

In Canada:

1-877-BROTHER (voice)

Storing Numbers

Storing One Touch Dial Numbers

- 1 Press **Menu**, **2**, **3**, **1**.
- 2 Press the One Touch key where you want to store the number.
- 3 Enter a number (up to 20 digits), and then press **Set**.
- 4 Enter a name (or leave it blank), and then press **Set**.
- 5 Press **Stop/Exit**.

Storing Speed Dial Numbers

- 1 Press **Menu**, **2**, **3**, **2**.
- 2 Enter a three-digit Speed Dial number, and then press **Set**.
- 3 Enter a number (up to 20 digits), and then press **Set**.
- 4 Enter a name (or leave it blank), and then press **Set**.
- 5 Press **Stop/Exit**.

Telephone Operation

One Touch Dialing/ Speed Dialing

- 1 Pick up the handset—**OR**—Press **Hook** and listen for a dial tone.
- 2 When you hear the dial tone, press the One Touch key of the location you want to call—**OR**—Press **Search/Speed Dial**, press **#**, and then press the three-digit Speed Dial number. (If you pressed **Hook** to dial, pick up the handset when the other party answers.)
- 3 To hang up, replace the handset.

Search/Speed Dial

- 1 Press **Search/Speed Dial**, then enter the first letter of the name you're looking for.
- 2 Press **←** or **→** to search the memory.
- 3 When the name is displayed, lift the handset—**OR**—Press **Hook**.
- 4 Press **Fax Start** to dial. (If you pressed **Hook** to dial, pick up the handset when the other party answers.)
- 5 To hang up, replace the handset.

Making Copies

Single Copy

- 1 Place the original face down in the ADF.
- 2 Press **Copy**.

Sorting Multiple Copies

- 1 Place the original face down in the ADF.
- 2 Use the dial pad to enter the number of copies you want (up to 99).
- 3 Press **Options**, press **←** or **→** to select **OPT:STACK/SORT**, and then press **Set**. Press **←** or **→** to select **SORT**, and then press **Set**.
- 4 Press **Copy**.

Table of Contents

1

Introduction.....	1-1
Using This Manual	1-1
Finding Information.....	1-1
Conventions Used in this Manual.....	1-1
Test Sheet Procedure and Product Registration (For USA Only) ...	1-2
To Complete Your FAX-4750e or FAX-5750e	
Registration On-Line (For USA Only)	1-2
Control Panel Overview	1-3
About Fax Machines	1-5
Custom Features	1-5
Do You Have Voice Mail on the Phone Line?	1-5
Why Should There Be Trouble?	1-5
How Can You Avoid Possible Problems?	1-5
Fax Tones and Handshake.....	1-6
ECM (Error Correction Mode).....	1-6

2

Assembly and Connections.....	2-1
Packing List.....	2-1
Choosing a Location.....	2-2
Assembly.....	2-3
Installing the Drum Unit Assembly	
(with Toner Cartridge).....	2-3
Attaching the Trays	2-4
Connecting Paper Cassette #2 (Option for FAX-4750e).....	2-4
Manual Feed Slot.....	2-5
Paper.....	2-6
Acceptable Paper	2-6
Paper Capacity of Paper Cassette	2-6
Paper Specification for the Cassette	2-6
Manual Feed Slot	2-7
Loading Paper in Paper Cassette	2-7
Connections	2-9
Connecting the Machine.....	2-9
Connecting an External Telephone	2-10
Connecting an External TAD	
(Telephone Answering Device).....	2-10
Sequence	2-10
Connections.....	2-10

Recording Outgoing Message (OGM) on External TAD..	2-11
Special Line Considerations	2-12
Roll Over Phone Lines	2-12
Two-Line Phone System	2-12
Converting Telephone Wall Outlets	2-12
Installing Machine, External Two-Line TAD, and Two-Line Telephone	2-13
Multi-Line Connections (PBX)	2-14
If you are installing the machine to work with a PBX:...	2-14
Custom Features on Your Phone Line.....	2-14

3

On-Screen Programming.....	3-1
User-Friendly Programming.....	3-1
Menu Mode	3-1
Menu Selection Table.....	3-3

4

Initial Setup.....	4-1
Getting Started.....	4-1
Setting Paper Size	4-1
Turning on Cassette #2 (Option for FAX-4750e)	4-1
Setting Cassette Usage	4-2
Setting Date and Time	4-2
Setting Station ID	4-3
Entering Text.....	4-4
Inserting Spaces	4-4
Making Corrections.....	4-4
Repeating Letters	4-4
Special Characters and Symbols	4-4
Setting the Ring Volume	4-5
Setting the Beeper Volume.....	4-5
Setting the Speaker Volume	4-5
Setting the Handset Volume	4-6
Choosing the Handset Volume (For Volume Amplify)	4-6
Setting Volume Amplify (For the Hearing-Impaired).....	4-7
Memory Storage	4-7
Turning On Automatic Daylight Savings Time	4-7
Toner Save.....	4-8
Sleep Mode	4-8
Setting Tone/Pulse Dialing Mode	4-8

Setup Receive	5-1
Basic Receiving Operations	5-1
Select Your Receive Mode	5-1
Setting Ring Delay	5-2
Setting F/T Ring Time (For FAX/TEL Mode Only).....	5-2
Easy Receive	5-3
Printing a Reduced Incoming Document	5-3
Setting the Print Density.....	5-4
Advanced Receiving Operations	5-5
Operation from Extension Telephone or External Telephone	5-5
For FAX/TEL Mode Only	5-5
Changing Remote Codes.....	5-5
Printing a Fax in Memory.....	5-6
Memory Security	5-6
Setting Up the Password	5-6
Turning Memory Security ON	5-6
Turning Memory Security OFF.....	5-7
Polling.....	5-7
Setting Up Polling Receive	5-7
Setting Up Sequential Polling Receive	5-8
Canceling a Scheduled Job	5-8

Setup Send	6-1
Before You Begin.....	6-1
Using the ADF (Automatic Document Feeder).....	6-1
Sending Faxes with Multiple Settings	6-2
Manual Transmission	6-2
Automatic Transmission.....	6-2
Manual and Automatic Fax Redial.....	6-2
Dual Access	6-3
Real Time Transmission.....	6-3
Checking the Jobs Status	6-4
Canceling a Job While Scanning the Original.....	6-4
Canceling Jobs in Memory	6-4
Basic Sending Operations	6-5
Contrast.....	6-5
Fax Resolution.....	6-5
Composing Electronic Cover Page.....	6-6
Composing Your Own Comments.....	6-7
Cover Page for the Next Fax Only.....	6-7

Always Send Cover Page.....	6-8
Using a Printed Cover Page	6-8
Advanced Sending Operations	6-9
Overseas Mode	6-9
Delayed Timer	6-9
Delayed Fax	6-10
Delayed Batch Transmission	6-10
Setting Up Polling Transmit	6-11

7

Auto Dial Numbers and Dialing Options	7-1
Storing Numbers for Easy Dialing	7-1
Storing One Touch Dial Numbers	7-1
Storing Speed Dial Numbers	7-2
Changing One Touch and Speed Dial Numbers.....	7-2
Setting Up Groups for Broadcasting	7-3
Dialing Options	7-4
Manual Dialing.....	7-4
Search	7-4
Speed Dialing	7-5
One Touch Dialing	7-5
Broadcasting.....	7-6
Access Codes and Credit Card Numbers.....	7-7
Pause.....	7-7
Hold	7-7
Redial.....	7-7
Tone/Pulse (For Canada Only).....	7-7

8

Telephone Services	8-1
Custom Features	8-1
Distinctive Ring.....	8-1
What Does Your Telephone Company's	
"Distinctive Ring" Do?.....	8-1
What Does Brother's "Distinctive Ring" Do?	8-1
Do You Have Voice Mail?.....	8-2
Before You Choose the Ring Pattern to Register	8-2
Very Important	8-3
Registering the Distinctive Ring Pattern.....	8-3
Caller ID	8-3
Viewing Caller ID List.....	8-4
Clearing a Caller ID Stored in Memory.....	8-4
Printing Caller ID List.....	8-4

9

Remote Fax Options.....	9-1
Fax Forwarding/Paging	9-1
Programming a Fax Forwarding Number.....	9-1
Programming Your Pager Number.....	9-2
Setting Fax Storage	9-3
Backup Print	9-3
Changing Remote Retrieval Access Code	9-3
Remote Retrieval.....	9-4
Using Remote Retrieval Access Code.....	9-4
Remote Commands	9-5
Retrieving Fax Messages.....	9-6
Changing Fax Forwarding Number.....	9-6

10

Printing Reports.....	10-1
Machine Settings and Activity	10-1
Customizing the Transmission Verification Report	10-1
Setting the Fax Activity Report Interval	10-1
Using the Reports Key.....	10-2

11

Making Copies.....	11-1
Using Your Machine as a Copier	11-1
Making a Single Copy	11-1
Making Multiple Copies.....	11-1
Out of Memory Message.....	11-2
Temporary Copy Settings.....	11-2
Copying Using Multiple Settings	11-2
Using the Enlarge/Reduce Key	11-3
Copy Contrast.....	11-4
Using the Options Key	11-4
Number of Copies	11-4
Sorting Multiple Copies.....	11-5
Special Layout Options.....	11-5
Paper Type.....	11-6
Changing Default Copy Settings.....	11-7
Copy Mode (Type of Original).....	11-7
Copy Contrast.....	11-8
Paper Type.....	11-8

12

Printer Driver Settings (For Windows® Only)	12-1
Using the Brother FAX-4750e and FAX-5750e Printer Driver....	12-1

Features in the Printer Driver	12-1
Basic Tab.....	12-2
Paper Size	12-3
Multiple Page.....	12-3
Border Line.....	12-3
Orientation.....	12-3
Copies.....	12-3
Collate.....	12-4
Media Type.....	12-4
Advanced Tab.....	12-5
Print Quality	12-5
Resolution	12-5
Toner Save	12-5
Print Setting (For Windows® 95/98/98SE/Me Only)....	12-6
Duplex Printing	12-6
Manual Duplex.....	12-6
Binding Offset.....	12-6
Watermark	12-7
Print Watermark.....	12-7
In Background.....	12-7
Watermark Text	12-8
Watermark Bitmap.....	12-8
Position	12-8
Page Setting.....	12-9
Device Options	12-10
Quick Print Setup	12-11
Administrator (For Windows® 95/98/98SE/Me Only)....	12-11
Print Date & Time	12-12
Accessories Tab.....	12-13
Paper Source Setting.....	12-13
Default Source	12-13
Available Options	12-13
Support	12-14
Brother Solutions Center	12-14
Web Update	12-14
Check Setting.....	12-14
Features in the Printer Driver (For Windows® 2000).....	12-15
General Tab	12-15
Printing Preferences	12-15
Layout Tab.....	12-16
*1 Orientation	12-16

*2 Pages Per Sheet	12-17
Paper/Quality Tab.....	12-17
*1 Paper Source	12-17
*2 Media	12-18
Advanced Options.....	12-18
*1 Paper /Output	12-18
*2 Graphic.....	12-19
*3 Document Options	12-19
Device Settings Tab.....	12-20
Installable Options	12-20

13

For DOS Users (For FAX-5750e Only) 13-1

How to Use the Brother machine with Your DOS	
Application Software	13-1
What Does the Remote Printer Console Do?	13-1
Remote Printer Console Main Program.....	13-1
Installing the Remote Printer Console.....	13-2
Using the Remote Printer Console Main Program.....	13-2

14

Using the Windows®-Based Brother MFL-Pro Control Center

(Not Available for FAX-4750e) 14-1

Brother Control Center.....	14-1
AutoLoad the Brother Control Center.....	14-2
How to Turn Off AutoLoad.....	14-2
Brother Control Center Features	14-3
Auto Configuration.....	14-3
Scanning Operations.....	14-3
Copy Operations.....	14-4
PC Fax Operation	14-4
Scanner Settings for Scan, Copy and PC Fax Buttons	14-4
Global Settings	14-4
Setting Up the Scanner Configurations	14-5
To Access the Scanner Configuration Screen:	14-5
Perform an Operation from the Control Center Screen.....	14-5
Scan to File.....	14-6
Scanner Settings	14-6
Destination Folder	14-7
Scan to E-mail	14-7
Scanner Settings	14-8
E-mail Application	14-8
File Attachments.....	14-8

Conversion Options	14-9
Format	14-9
Show QuickSend Menu	14-9
QuickSend List.....	14-9
Scan to Word Processor	14-10
Scanner Settings	14-10
Word Processor	14-11
User-Defined Button	14-12
Scanner Settings	14-12
Target Application.....	14-12
Copy	14-13
Scanner Settings	14-13
Copy Settings.....	14-13
Send a Fax	14-14
Scanner Settings	14-14
Fax Settings	14-14

15

How to Scan Using Windows®.....	15-1
For FAX-4750e: How to Access the Scanner	15-1
PreScanning an Image	15-1
Scanning a Document into Your PC	15-2
Settings in the Scanner Window.....	15-3
Image.....	15-3
Contrast.....	15-3
Custom	15-4
For FAX-5750e: Scanning and Using ScanSoft™ PaperPort® and TextBridge® OCR	15-5
Viewing Items in PaperPort®	15-6
Organizing Your Items in Folders.....	15-6
Quick Links to Other Applications.....	15-7
ScanSoft™ TextBridge® OCR Lets You Convert Image Text to Text You Can Edit.....	15-7
How to Access the Scanner	15-8
PreScanning an Image	15-8
Scanning a Document into Your PC	15-9
Settings in the Scanner Window.....	15-10
Image.....	15-10
Contrast.....	15-10
Custom	15-11
You Can Import Items from Other Applications.....	15-11
You Can Export Items in Other Formats.....	15-12

Exporting an Image File.....	15-12
------------------------------	-------

16

Setting Up and Using PC-FAX (For Windows® Only)	16-1
Introduction	16-1
Brother Resource Manager.....	16-1
FAX Remote Setup	16-2
PC-FAX Sending (For Windows® Only)	16-3
Setting Up User Information	16-3
Setting Up Sending.....	16-4
Outside line access	16-4
Include header	16-4
Address Book file.....	16-4
Internet PC-FAX	16-4
User interface.....	16-5
Simple Style	16-5
Facsimile Style.....	16-5
Setting Up Speed Dial	16-6
The Address Book	16-7
Setting Up a Member in the Address Book.....	16-8
Setting Up a Group for Broadcasting	16-9
Editing Member Information.....	16-9
Deleting a Member or Group	16-10
Exporting the Address Book	16-10
Importing to the Address Book	16-11
Setting Up Cover Page	16-12
To	16-13
From.....	16-13
Comment.....	16-13
Select Cover Page Form.....	16-13
Import BMP file.....	16-13
Count Cover Page	16-13
Sending a File as a PC-FAX Using the Simple Style.....	16-14
Sending a File as a PC-FAX Using the Facsimile Style ..	16-15

17

How to Print, Fax and Scan Using Apple® Macintosh®	17-1
For FAX-4750e: Set up Your USB Equipped Apple®	
Macintosh® with Mac OS 8.5-9.2	17-1
How to Print Using Brother Printer Driver	17-1
How to Send a Fax from a Macintosh®	17-3
Setting Up Your Address Book.....	17-5
Adding a New Member.....	17-5

Adding a New Group	17-6
How to Scan Using the Brother TWAIN Scanner Driver	17-7
For FAX-4750e Users	17-7
For FAX-5750e Users	17-7
How to Access the Scanner	17-8
For FAX-4750e Users	17-8
For FAX-5750e Users	17-8
PreScanning an Image	17-8
Scanning a Document into Your Macintosh	17-9
Settings in the Scanner Window	17-10
Image	17-10
Scanning Area	17-10
Business Card Size	17-11
Miscellaneous	17-11
Contrast	17-11

18

Optional Accessories	18-1
Memory Board (For FAX-4750e and FAX-5750e Only)	18-1
Installing the Optional Memory Board	18-1
Paper Cassette #2 (Option for FAX-4750e)	18-4
Network (LAN) Board (Option for FAX-4750e)	18-4

19

Troubleshooting and Routine Maintenance	19-1
Troubleshooting	19-1
Error Messages	19-1
Document Jam	19-4
Paper Jam	19-4
Paper is Jammed in the Paper Cassette	19-5
Paper is Jammed near the Drum Unit	19-5
Paper is Jammed in the Fuser Unit	19-5
If You Are Having Difficulty with Your Machine	19-6
Packing and Shipping the Machine	19-15
Routine Maintenance	19-18
Cleaning the Document Scanner	19-18
Cleaning the Printer	19-18
Cleaning the Drum Unit	19-19
Replacing the Toner Cartridge	19-20
Toner Empty Indicator	19-20
Replacing the Drum Unit	19-23
Checking the Drum Life	19-24

Important Information	20-1
Standard Telephone and FCC Notices	20-1
Laser Safety	20-2
FDA Regulations	20-2
Manufactured	20-2
Federal Communications Commission (FCC) Declaration of Conformity (For USA Only)	20-3
Important.....	20-4
Industry Canada Compliance Statement (For Canada Only).....	20-4
Warranty	20-4
Important Safety Instructions	20-4
Trademarks.....	20-6
 Glossary.....	 G-1
 Specifications	 S-1
Product Description.....	S-1
General	S-1
Paper.....	S-1
Paper Specifications for the Cassette	S-1
Manual Feed Slot.....	S-1
Copy	S-1
Fax	S-2
Scanner (Option for FAX-4750e. Standard for 5750e.).....	S-3
Consumable Items	S-3
Electrical and Environment.....	S-3
Printer	S-4
TrueType Fonts on CD-ROM	S-4
Computer Requirements.....	S-5
Parallel Interface Specifications	S-5
USB (Universal Serial Bus) Interface Specifications.....	S-6
Resident Fonts (For FAX-5750e Only).....	S-6
Symbol Sets/Character Sets	S-6
 Index.....	 I-1
Remote Retrieval Access Card.....	R-1

1 Introduction

Using This Manual

Thank you for purchasing a Brother fax machine.

This machine has been designed to be simple to use, with LCD screen prompts to guide you through programming your machine. However, you can use your machine to its fullest potential by taking a few minutes to read this manual.







Additionally, your machine has a **Reports Key**. Press **Reports, 1** to print a list of basic step instructions and explanations.

Finding Information

All chapter headings and subheadings are listed in the Table of Contents. You will be able to find information about a specific feature or operation by checking the Index in the back of this manual.

Conventions Used in this Manual

Throughout this manual you'll see special symbols alerting you to important information, warnings, and actions to perform. For clarification, and to help you choose the correct key presses, we've added illustrations of some of the LCD messages.

- | | |
|---|---|
| boldface | Bold typeface identifies a specific key on the machine control panel. |
| <i>italics</i> | Italics typeface emphasize an important point, or refer you to related topic. |
| bubble dot | Bubble Dot typeface identifies the messages on the LCD of the machine. |
|  | Warnings detail precautions you must take to avoid possible personal injury. |
|  | Cautions specify procedures you must follow or avoid to prevent possible damage to the machine. |
|  | Notes tell you the proper response for a situation that may occur. |
|  | FYI tips provide details about how the current operation interacts with other features. |
|  | Improper Setup alerts you to devices and procedures that are not compatible with the machine. |

Test Sheet Procedure and Product Registration (For USA Only)

After programming your Station ID, please fill out the TEST SHEET included with your machine and then fax it to Brother's Automated Fax Response System as your first transmission. This will verify that your machine is properly installed. To receive a response, you must set up your Station ID. (See *Setting Station ID*, Page 4-3.)

When this document is received, a confirmation sheet and Product Registration form will be sent back to your machine. Please fill out the form and return it to complete your registration.

In USA: 1-877-268-9575 (fax)

To Complete Your FAX-4750e or FAX-5750e Registration On-Line (For USA Only)

- 1** Insert the MFL Pro CD-ROM into your CD-ROM drive.
- 2** Click **On-Line Registration** to register your product on-line from the main menu.

Control Panel Overview

FAX-4750e and FAX-5750e have the same control panel keys.

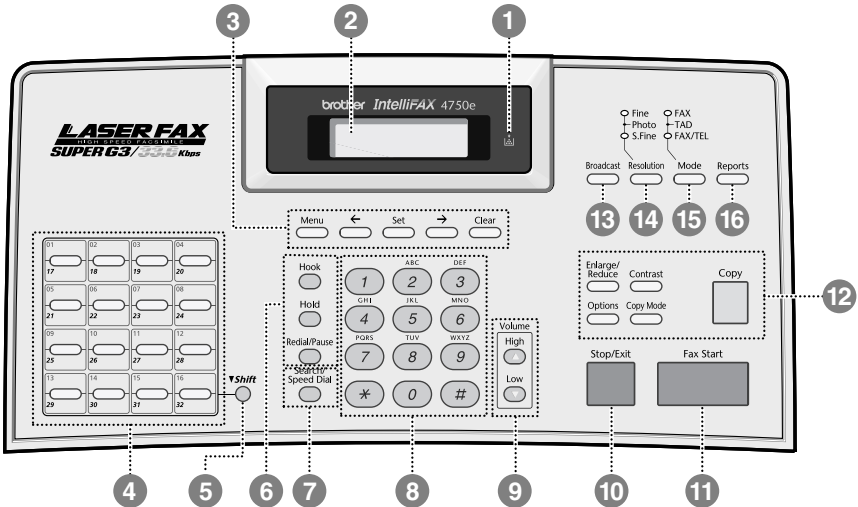

1 Toner Empty Icon

The Toner icon flashes on and off when toner is low, so you'll know to order another toner cartridge. You will be able to print until the indicator stays on.

2 LCD (Liquid Crystal Display)

Displays messages to help you set up and operate your machine.

3 Programming Keys:

Menu

Lets you access the Menu and Programming mode.

Set

Stores a menu setting in the machine. Also use for sending one fax to multiple numbers.

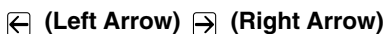

Moves the LCD cursor through text and options.

Clear

Deletes entered data or backs up one step in Menu table.

4 One Touch Dial Keys

These 16 keys give you instant access to previously stored phone numbers.

5 Shift

To access memory locations 17 through 32 in the One Touch keys, hold down the Shift key.

6 Telephone Keys:

Hook

Lets you dial telephone and fax numbers without lifting the handset.

Hold

Lets you place calls on hold.

Redial/Pause

Redials the last number called. Also inserts a pause in autodial numbers.

7 Search/Speed Dial

Lets you look up numbers stored in the dialing memory. Also lets you dial stored phone numbers by pressing # and a three-digit number.

8 Dial Pad

Dials phone and fax numbers, and can be used as a keyboard for entering information into the machine.

(For Canada only) The # key lets you switch the dialing type during a telephone call from **PULSE** to **TONE**.

9 Volume High/Low Keys

Lets you adjust speaker, ring and handset volume.

10 Stop/Exit

Stops a fax, cancels an operation or exits from Menu mode.

11 Fax Start

Starts an operation, such as sending a fax.

12 Copy Keys:

Enlarge/Reduce

Lets you enlarge or reduce copies depending upon the ratio you select.

Contrast

Let you make a copy that is lighter or darker than the original.

Options

You can quickly and easily change your temporary settings (for the next copy only).

Copy Mode

Select the copy resolution for your type of original document.

Copy

Makes a copy.

13 Broadcast

Use this key when you send the same fax to many different locations (maximum of 282 locations at once).

14 Resolution and Indicator Lights

These LEDs show the Resolution you selected.

15 Mode and Indicator Lights

These LEDs show the Receive Mode you selected.

16 Reports

Accesses the Reports menu so you can select reports to print: Help List, Auto Dial, Fax Activity, Transmission Verification, and User Settings.

About Fax Machines

If you're a first-time fax machine user, fax operation might seem a little mysterious. Soon, you'll recognize the unusual fax tones on your phone line, and be able to send and receive faxes easily.

Custom Features

Do You Have Voice Mail on the Phone Line?

If you have Voice Mail on the phone line on which you will install your new fax machine, *there is a strong possibility that Voice Mail and the fax machine will conflict with each other while receiving incoming calls.*

Why Should There Be Trouble?

Since both fax machines and Voice Mail pick up the line at the number of rings you have set, each of them has the ability to keep the other from receiving calls. For example, if your Voice Mail is set to answer after two rings and your fax machine is set to answer after four, your Voice Mail will keep your fax machine from receiving faxes. If you set Voice Mail and the Brother machine to answer at the same number of rings, there is no way of knowing which one will answer first. It is important to remember that neither Voice Mail nor the fax machine can pass the call back to the other after the call has been answered.

How Can You Avoid Possible Problems?

A very good way to avoid a problem like the one mentioned previously is *to get a second phone number on your present phone line.* Many people with Voice Mail opt for this choice, which is called "Distinctive Ring", and they are very satisfied with it. *For details about this type of custom service, please see Distinctive Ring, page 8-1.*

Another way to avoid a possible problem is to replace your Voice Mail with an answering machine. Your Brother fax machine is designed to work in tandem with an answering machine or TAD (telephone answering device). (See *Connecting an External TAD (Telephone Answering Device)*, Page 2-10.)

Fax Tones and Handshake

When someone is sending a fax, the machine sends fax calling tones (CNG tones)—soft, intermittent beeps at 4-second intervals. You'll hear them when you dial and press **Fax Start**; they continue for about 60 seconds after dialing. During that time, the sending machine must begin the “handshake” with the receiving machine. Each time you use automatic procedures to send a fax, you are sending CNG tones over the phone line. You'll soon learn to listen for these soft beeps each time you answer a phone on your fax line, so you can know if you are receiving a fax message.

The receiving fax responds with fax receiving tones—loud, chirping sounds. A receiving fax chirps for about 60 seconds over the phone line, and the LCD shows **RECEIVING**. If your machine is set to the FAX mode, it will answer every call automatically with fax receiving tones. Even if the other party hangs up, your machine continues to send the “chirps” for about 60 seconds, and the screen continues to display **RECEIVING**. To cancel the receiving mode, press **Stop/Exit**.

When your machine answers in FAX/TEL mode, the machine listens for CNG tones and then responds with receiving tones.

The fax “handshake” is the time in which the sending machine's CNG tones and the receiving machine's “chirps” overlap. This must be for at least 2 to 4 seconds, so the machines can understand how each is sending and receiving the fax. The handshake cannot begin until the call is answered, and the CNG tones only last for about 60 seconds after the number is dialed. Therefore, it's important for the receiving machine to answer the call in as few rings as possible.



When you have an external telephone answering device (TAD) on your fax line, your TAD will determine the number of rings before the call is answered. Pay special attention to the directions in the Assembly and Connections chapter for connecting a TAD to your machine.

ECM (Error Correction Mode)

The Error Correction Mode (ECM) is a way for the machine to check the integrity of a fax transmission while it is in progress. ECM transmissions are possible only between machines that both have the ECM feature. If they do, you may send and receive fax messages that are continuously checked for their integrity. Sufficient memory must be available in your machine for this feature to work.

2

Assembly and Connections

Packing List

Make sure you have the following items:

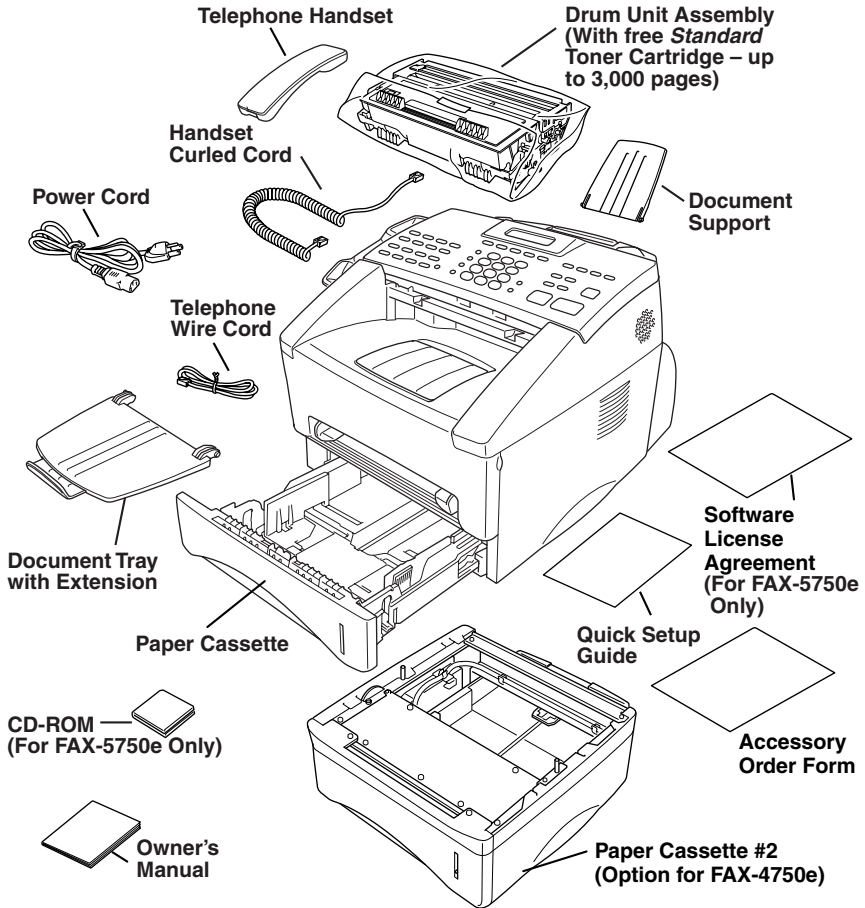

Note If an item is missing, call Brother Customer Service at 1-800-284-4329 (**in USA**), 1-877-BROTHER (**in Canada**) or (514) 685-6464 (**in Montreal**). See *Ordering Accessories and Supplies*, Page ii for the correct item numbers.

! Whenever you transport the machine, use the packing materials that came with your machine. If you do not pack the machine correctly, you may void your warranty.

Choosing a Location

Place your machine on a flat, stable surface, such as a desk. Select a place that is free of vibration and shocks. Locate the machine near a telephone jack and a standard, grounded power outlet.

- ⊘ Avoid placing your machine in a high-traffic area. Do not place near heaters, air conditioners, water, chemicals or refrigerators. Do not expose the machine to direct sunlight, excessive heat, moisture or dust. Make sure nothing blocks the flow of air from the fan on the sides of the machine. Do not connect your machine to electrical outlets controlled by wall switches or automatic timers. Disruption of power can wipe out information in the unit's memory. Do not connect your machine to electrical outlets on the same circuit as large appliances or other equipment that might disrupt the power supply. Avoid interference sources, such as speakers or the base units of cordless phones.



! WARNING

- Never install telephone wiring during a lightning storm.
- We recommend that this product be used with a surge protection device to protect the product against lightning storms.
- Never install a telephone jack in a wet location unless the jack is specifically designed for a wet location.
- Never touch telephone wires or terminals that are not insulated unless the telephone line has been disconnected at the network interface.
- Use caution when installing or modifying telephone lines.
- Avoid using a telephone (other than a cordless type) during an electrical storm. There may be a remote risk of electric shock from lightning.
- Do not use the telephone to report a gas leak in the vicinity of the leak.
- For PLUGGABLE EQUIPMENT, the socket-outlet should be installed near the equipment and should be easily accessible.
- To reduce the risk of shock or fire, use only a No. 26 AWG or larger telecommunications line cord.

Assembly

Installing the Drum Unit Assembly (with Toner Cartridge)

- 1 Unpack the drum unit assembly, including the toner cartridge, and gently rock it from side to side five or six times to distribute the toner evenly inside the cartridge.

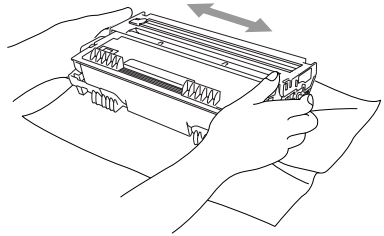

! To prevent damage to the drum, do not expose it to light for longer than a few minutes.

- 2 Open the front cover of the machine.

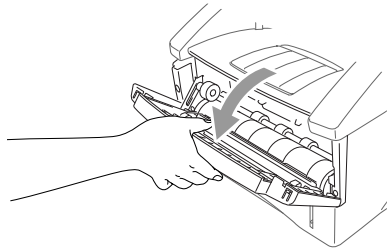

- 3 Insert the drum unit assembly into the machine.

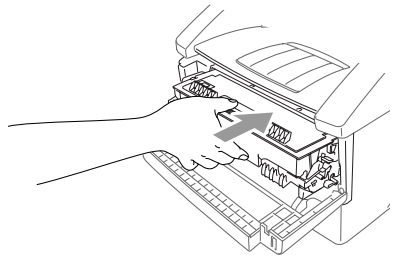

- 4 Close the front cover.

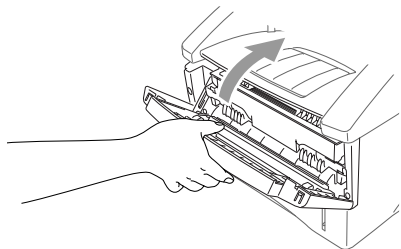

Attaching the Trays

- 1 Attach the Document Support and Document Tray with Extension.

Unfold the extension, which holds documents in place.

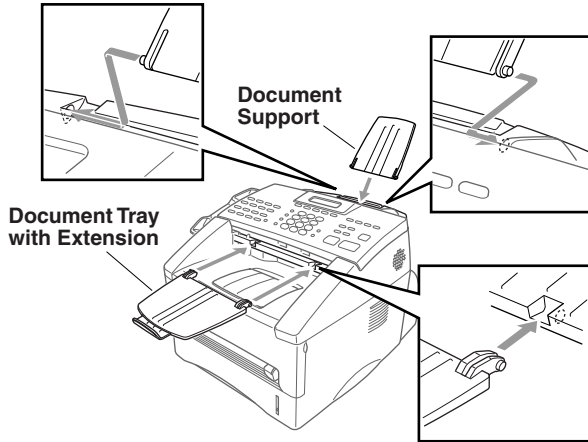

- 2 Unfold the Front Output Bin Extension, which holds printed pages in place.

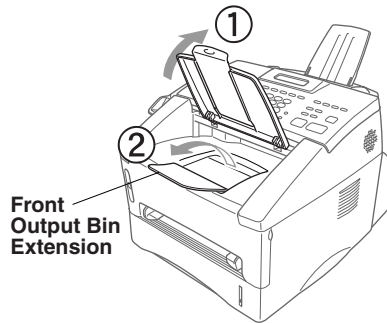

Connecting Paper Cassette #2 (Option for FAX-4750e)

- 1 Carefully pick up the machine and place it on top of Paper Cassette #2.

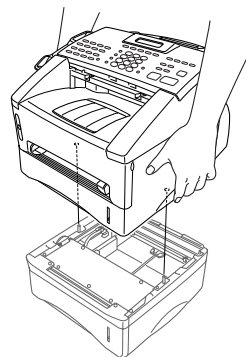

- 2 Plug the modular cable from Cassette #2 into the modular jack on the Brother machine.

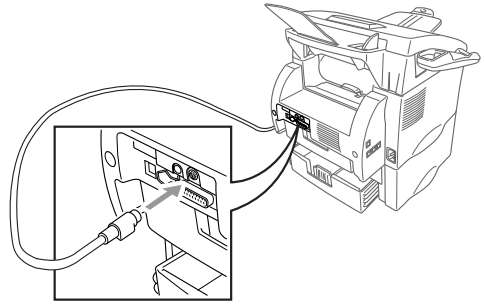

- 🔍 To select which cassette will be used for printing, see *Setting Cassette Usage*, Page 4-2.
- 🔍 If you move the machine after connecting Cassette #2, be sure to carefully lift Cassette #2 with the machine because they are not attached.

Manual Feed Slot

Use the manual feed slot to print or copy on envelopes, labels, transparencies, card stock or thicker paper:

The manual feed slot is above the paper cassette. Load paper or envelopes *one at a time*. You do not have to remove paper from the paper cassette.

You do not have to choose Manual Feed in the Setup dialog box of your printer driver. Insert the sheet of paper for Portrait (vertical) or Landscape (horizontal), with the side you wish to print on face up in the manual feed slot.

- 1 Align the paper at the center of the manual feed slot and insert the paper into the manual feed slot until the front edge of the paper touches the paper feed roller.
- 2 Adjust the paper guides to the width of the paper.

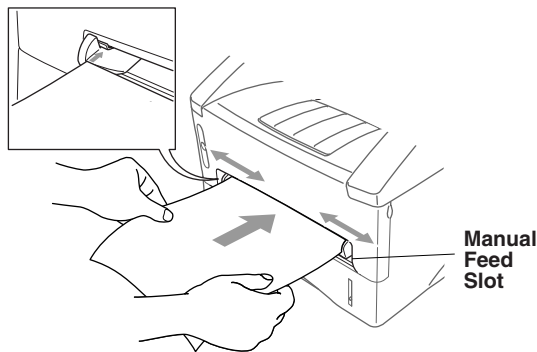

Paper

Acceptable Paper

	Paper Type	Paper Size
Paper Cassette #1 & #2:	cut sheet	Letter, Legal, A4, A5, ISO B5, Executive
Manual Feed Slot:	cut sheet	Letter, Legal, A4, A5, B5 (JIS/ISO), Executive, 2.75–8.5 × 4.57–14 inches (70–216 × 116–356 mm)
	envelopes	COM-10, Monarch, C5, DL
	post cards	–
	labels and transparencies	Letter, A4



We Recommend: Cut sheet:	Xerox 4200DP 20 lb, Champion Paper One 20 lb, Hammermill Laser Paper 24 lb
Labels:	Avery <i>laser</i> label #5160
Transparencies:	3M CG3300 for <i>laser</i> printers or equivalent

Paper Capacity of Paper Cassette

Paper Cassette #1 & #2:	Max. paper height is 1.06 inches (27 mm) (use the guides) or approx. 250 sheets of 20 lb. (75 g/m ²) Letter/A4 paper, 10 transparencies.
Front Output Bin:	Approx. 150 sheets of 20 lb. (75 g/m ²) Letter/A4 paper

Paper Specification for the Cassette

Cut Sheet	
Basis Weight:	16 to 28 lb. (60 to 105 g/m ²)
Caliper:	0.003 to 0.005 inches. (0.08 to 0.13 mm)
Moisture Content:	4% to 6% by weight

Manual Feed Slot

	Cut Sheet	Envelopes
Basis Weight:	16 to 43 lb. (60 to 161 g/m ²)	20 to 24 lb. (75 to 90 g/m ²)
Caliper:	0.003 to 0.008 inches. (0.08 to 0.2 mm)	0.003 to 0.005 inches. (0.084 to 0.14 mm)
Moisture Content:	4% to 6% by weight	4% to 6% by weight



Fax messages can be received on only Letter, Legal and A4 size paper. If you use legal or A4, change the Paper Size setting: **(Menu, 1, 1.)**

Loading Paper in Paper Cassette

- 1 Pull the paper cassette completely out of the machine.

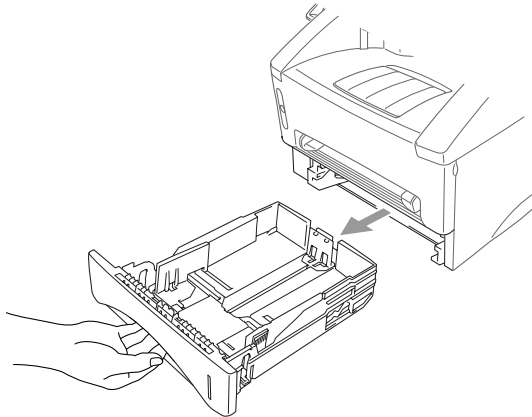

- 2 Slide the paper width and length adjusters for the paper size you want.

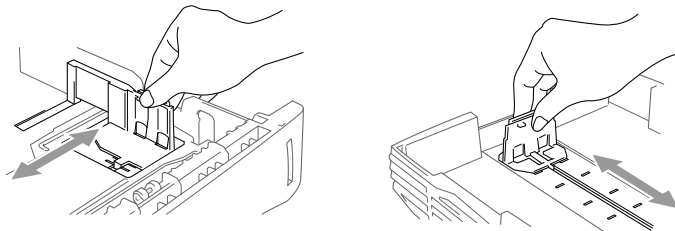

- 3** Fan the paper well. Load paper in the paper cassette. Press down on the paper to flatten it in all four corners, keeping the paper level below the guide. The cassette can hold up to 250 sheets of 20 lb (75g/m²) paper.

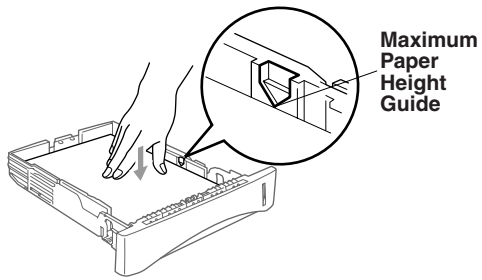

- 4** Slide the paper cassette into the machine until it locks into place.

Connections

Connecting the Machine

Connect the handset, power cord, and telephone line.

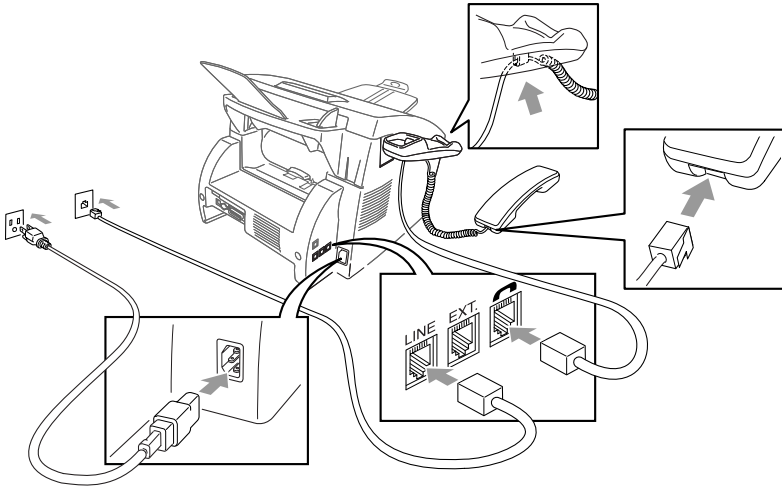

1 Connecting the Handset

Connect the curled handset cord to the bottom of the handset and the left side of the machine.

2 Connect the power cord.

3 Connect the telephone line.

Connect one end of the telephone line cord to the jack labeled **LINE** on the left side of the machine. Connect the other end to a modular wall jack.

WARNING

- This machine must be grounded using a three-prong plug.
- Since the machine is grounded through the power outlet, you can protect yourself from potentially hazardous electrical conditions on the telephone line by keeping the power to your machine on when you connect it to a telephone line. When you want to move your machine, protect yourself by disconnecting the telephone line first, and then the power cord.
- Lightning and power surges can damage this product! We recommend that you use a quality surge protection device on the AC power line and on the telephone line, or unplug the lines during a lightning storm.
- Do not touch the rollers at the paper exit.

Connecting an External Telephone

Your machine is equipped with a handset that you can use as a regular phone. However, you can also connect a separate telephone (or telephone answering device) directly to your machine.

Connect the modular plug on the telephone's line cord to the jack labeled EXT. on the left side of the machine.

Whenever this phone (or TAD) is in use, the LCD shows **EXT. TEL IN USE**, and, if the machine handset is lifted, an alarm sounds. To disconnect a call on the external phone and switch to the machine, press **Hook**.

Connecting an External TAD (Telephone Answering Device)

Sequence

You might choose to connect an answering system. When you have an **external** TAD on the same telephone line as the machine, the TAD answers all calls. The machine "listens" for fax calling (CNG) tones. If it hears them, the machine takes over the call and receives the fax. If it doesn't hear CNG tones, the machine lets the TAD continue playing your outgoing message so your caller can leave you a voice message.

The TAD must answer within four rings (the recommended setting is two rings). The machine cannot hear CNG tones until the TAD has answered the call, and with four rings there are only 8–10 seconds of CNG tones left for the fax "handshake." Make sure you carefully follow the instructions in this manual for recording your outgoing message. We do not recommend using the toll saver feature on your external answering machine if it exceeds 4 rings.

Connections

The external TAD must be plugged into the left side of the machine in the jack labeled EXT. Your machine cannot work properly if you plug the TAD into a wall jack.



If You Subscribe to your Telephone Company's Distinctive Ring Service:

You may connect an external TAD to a separate wall jack *only* if you subscribe to your telephone company's Distinctive Ring service, have registered the distinctive ring pattern on your machine, use that number as a fax number and have set your machine's Receive mode to **MANUAL**. The recommended setting is three or four rings on the external TAD when you have the telephone company's Distinctive Ring service.



If You Do Not Subscribe to Distinctive Ring Service:

You must plug your TAD into the EXT. jack of your Brother machine. If your TAD is plugged into a wall jack, both your machine and the TAD will try to control the phone line. (See illustration on Page 2-11.)

-  **Do not connect a TAD elsewhere on the same phone line.**

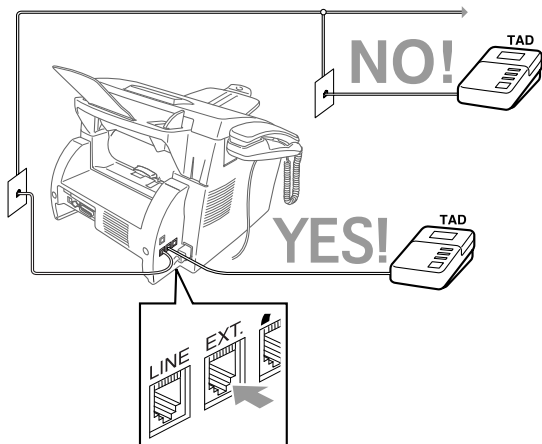

- 1** Plug the telephone line cord from the wall jack into the left side of the machine in the jack labeled **LINE**.
- 2** Plug the telephone line cord from your TAD into the left side of the machine in the jack labeled **EXT.** (Make sure this cord is connected to the TAD at the TAD's telephone line jack, and not its telephone set jack.)
- 3** Set your external TAD to four rings or less. (The machine's Ring Delay setting does not apply).
- 4** Record the outgoing message. (See below.)
- 5** Set the Receive mode to TAD by pressing **Mode** until both FAX and FAX/TEL lights are on.

Recording Outgoing Message (OGM) on External TAD

Timing is important in recording this message. The message sets up the ways to handle both manual and automatic fax reception.

- 1** Record 5 seconds of silence at the beginning of your message. (This allows your machine time to listen for the fax CNG tones of automatic transmissions before they stop.)
- 2** Limit your speaking to 20 seconds. (See *Easy Receive*, Page 5-3.)
- 3** End your 20-second message by giving your Fax Receive Code for people sending manual faxes. For example: **"After the beep, leave a message or send a fax by pressing *51 and Start."**



We recommend beginning your OGM with an initial 5-second silence because the machine cannot hear fax tones over a resonant or loud voice. You may try omitting this pause, but if your machine has trouble receiving, then you must rerecord the OGM to include it.

Special Line Considerations

Roll Over Phone Lines

A roll over phone system is a group of two or more separate telephone lines that pass incoming calls to each other if they are busy. The calls are usually passed down or “rolled over” to the next available phone line in a preset order.

Your machine can work in a roll over system as long as it is the last number in the sequence, so the call cannot roll away. Do not put the machine on any of the other numbers; when the other lines are busy and a second fax call is received, the fax call would be transferred to a line that does not have a fax machine. Your machine will work best on a dedicated line.

Two-Line Phone System

A two-line phone system is nothing more than two separate phone numbers on the same wall outlet. The two phone numbers can be on separate jacks (RJ11) or combined into one jack (RJ14). Your machine must be plugged into an RJ11 jack. RJ11 and RJ14 jacks may be equal in size and appearance and both may contain four wires (black, red, green, yellow). To test the type of jack, plug in a two-line phone and see if it can access both lines. If it can, you must separate the line for your machine.

Converting Telephone Wall Outlets

There are three ways to convert to an RJ11 receptacle. The first two ways may require assistance from the telephone company. You can change the wall outlets from one RJ14 jack to two RJ11 jacks. Or, you can have an RJ11 wall outlet installed and slave or jump one of the phone numbers to it.

The third way is the easiest: Buy a triplex adapter. You can plug a triplex adapter into an RJ14 outlet. It separates the wires into two separate RJ11 jacks (Line 1, Line 2) and a third RJ14 jack (Lines 1 and 2). If your machine is on Line 1, plug the machine into L1 of the triplex adapter. If your machine is on Line 2, plug it into L2 of the triplex adapter.

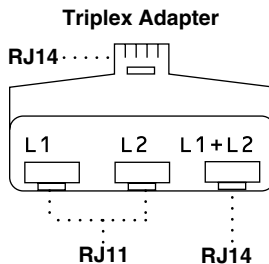

Installing Machine, External Two-Line TAD, and Two-Line Telephone

When you are installing an **external** two-line telephone answering device (TAD) and a two-line telephone, your machine must be isolated on one line at both the wall jack and at the TAD. *The most common connection is to put the machine on Line 2, which is our assumption in the following steps.* The back of the two-line TAD must have two telephone jacks: one labeled L1 or L1/L2, and the other labeled L2. You will need at least three telephone line cords, the one that came with your machine and two for your external two-line TAD. You will need a fourth line cord if you add a two-line telephone.

- 1 Place the two-line TAD and the two-line telephone next to your machine.
- 2 Plug one end of the telephone line cord for your fax machine into the L2 jack of the triplex adapter. Plug the other end into the **LINE** jack on the left side of the machine.
- 3 Plug one end of the first telephone line cord for your TAD into the L1 jack of the triplex adapter. Plug the other end into the L1 or L1/L2 jack of the two-line TAD.
- 4 Plug one end of the second telephone line cord for your TAD into the L2 jack of the two-line TAD. Plug the other end into the **EXT.** jack on the left side of the machine.

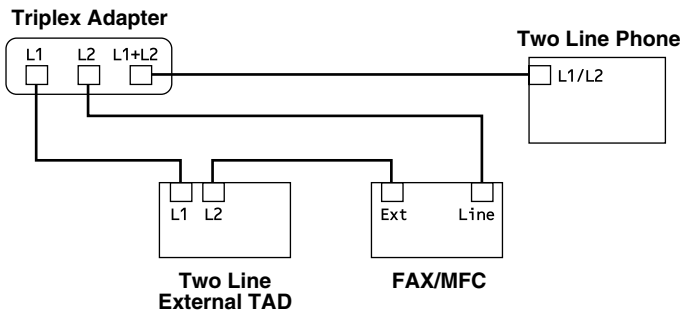

You can keep two-line telephones on other wall outlets as always. There are two ways to add a two-line telephone to the machine's wall outlet. You can plug the telephone line cord from the two-line telephone into the L1+L2 jack of the triplex adapter. Or, you can plug the two-line telephone into the TEL jack of the two-line TAD.

Multi-Line Connections (PBX)

Most offices use a central telephone system. While it is often relatively simple to connect the machine to a key system or a PBX (Private Branch Exchange), we suggest that you contact the company that installed your telephone system and ask them to connect the machine for you. It is advisable to have a separate line for the machine. You can then leave the machine in FAX mode to receive faxes any time of day or night.

If the machine is to be connected to a multi-line system, ask your installer to connect the unit to the last line on the system. This prevents the unit from being activated each time a telephone call is received.

-  As with all fax units, this machine must be connected to a two wire system. If your line has more than two wires, proper connection of the machine cannot be made.

If you are installing the machine to work with a PBX:

- 1** It is not guaranteed that the unit will operate correctly under all circumstances with a PBX. Any cases of difficulty should be reported first to the company that handles your PBX.
- 2** If all incoming calls will be answered by a switchboard operator, it is recommended that the Receive Mode be set to **MANUAL**. All incoming calls should initially be regarded as telephone calls.
- 3** The machine may be used with either pulse or tone dialing telephone service.

Custom Features on Your Phone Line

If you have Voice Mail, Call Waiting, Call Waiting/Caller ID, RingMaster, an answering service, or an alarm system, or other custom feature on one phone line, it may create a problem with the operation of your fax machine. (See *I have difficulty with custom features on a single line*, Page 19-8.)

3

On-Screen Programming

User-Friendly Programming

We have designed your machine with on-screen programming and a Reports key. User-friendly programming helps you take full advantage of all the menu selections your machine has to offer.

Since your fax programming is done on the LCD, we created step-by-step on-screen prompts to help you program your machine. All you need to do is follow the prompts as they guide you through the menu selections and programming options.

Menu Mode

You can access the Menu by pressing **Menu**. The LCD shows:

Then

For FAX-4750e:

Press **1** for General Setup—**OR**—

1. GENERAL SETUP

Press **2** for Fax Operations—**OR**—

2. FAX

Press **3** for Copy Operations—**OR**—

3. COPY

Press **4** for Network Operations.
(Option for FAX-4750e)

4. LAN

For FAX-5750e:

Press **1** for General Setup—**OR**—

1. GENERAL SETUP

Press **2** for Fax Operations—**OR**—

2. FAX

Press **3** for Copy Operations—**OR**—



3. COPY

Press **4** for Print Operations—**OR**—

4. PRINTER

Press **5** for Network Operations.

5. LAN

You can scroll more quickly by pressing . (Use  to scroll backward and see all options, in the opposite order.)

Before you press **Set** after entering information in a field using the dial pad, you can correct a mistake. Use  to back up and then type over the incorrect characters.

When you finish a setting, the LCD shows **ACCEPTED**.



If you want to exit the Menu Mode, press **Stop/Exit**.

Menu Selection Table

You can probably perform most of these programming operations without the Owner's Manual. To help you understand the menu selections and options that are found in the machine programs, use the Menu Selection Table below.

Main Menu	Submenu	Menu Selections	Options	Descriptions	Page
1. GENERAL SETUP	1. PAPER SIZE	—	LETTER LEGAL A4	Selects size of paper for received faxes.	4-1
	These settings appear if Cassette #2 was installed and set to ON.	CASSETTE #1	—	LETTER/ LEGAL/A4	4-2
		CASSETTE #2	—		
		CASSETTE USAGE	FOR FAX	AUTO/ CASSETTE #1 ONLY/ CASSETTE #2 ONLY	
	FOR COPY				
	2. DATE/TIME	—	—	Enter date and time for the LCD display and heading on fax transmissions.	4-2
	3. STATION ID	—	FAX TEL NAME	Program your name, fax number and telephone number to appear on each transmitted page.	4-3
	4. VOLUME	1. RING	OFF LOW MED HIGH	Adjusts ring volume.	4-5
		2. BEEPER	OFF LOW HIGH	Adjusts beeper volume.	4-5
		3. SPEAKER	OFF LOW MED HIGH	Adjusts speaker volume.	4-5
4. HANDSET		LOW HIGH	Adjusts handset volume.	4-6	
5. VOLUME AMPLIFY		ON (PERMANENT/ TEMPORARY) OFF	For the hearing-impaired, you can set the volume to the VOL AMPLIFY:ON setting on a permanent or temporary basis.	4-7	



The factory setting (option) is shown in bold.

Main Menu	Submenu	Menu Selections	Options	Descriptions	Page
1. GENERAL SETUP (continued)	5. CASSETTE #2	—	ON (FAX-5750e) OFF (FAX-4750e)	Turn CASSETTE #2 ON if you purchased the optional Cassette #2 for FAX-4750e.	5-3
	6. AUTO DAYLIGHT	—	ON OFF	Changes for Daylight Savings Time automatically.	4-7
	7. TONER SAVE	—	ON OFF	Increases life of toner cartridge.	4-8
	8. SLEEP MODE	—	—	Conserves power	4-8
	9. TONE/PULSE	—	TONE PULSE	Selects dialing mode	4-8
	0. LOCAL LANGUAGE (Canada Only)	—	ENGLISH FRENCH	Allows you to change the LCD Language to French.	See French Manual
2. FAX	1. SETUP RECEIVE	1. RING DELAY	00 01 02 03 04	Number of rings before the machine answers in FAX, TAD, FAX/TEL or MANUAL mode.	5-2
		2. F/T RING TIME	20 30 40 70	Sets the time for “double-ring” in FAX/TEL mode.	5-2
		3. EASY RECEIVE	ON SEMI OFF	Receive fax messages without pressing the Fax Start key.	5-3
		4. REMOTE CODE	ON (*51, #51) OFF	Activate or deactivate the machine from a remote location. You can type in new codes.	5-5



The factory setting (option) is shown in bold.

Main Menu	Submenu	Menu Selections	Options	Descriptions	Page	
2. FAX (continued)	1. SETUP RECEIVE (continued)	5. AUTO REDUCTION	ON OFF	Reduces size of image.	5-3	
		These settings appear if Cassette #2 was installed and set to ON.	CASSETTE #1	ON OFF		
			CASSETTE #2	ON OFF		
		6. PRINT DENSITY	- ■ ■ ■ □ □ +	Makes prints darker or lighter.	5-4	
	7. POLLING RX	ON OFF	Sets up your machine to poll another fax machine.	5-8		
	2. SETUP SEND	1. CONTRAST	AUTO S.LIGHT S.DARK	Changes lightness or darkness of a fax you are sending.	6-5	
		2. FAX RESOLUTION	STANDARD FINE S.FINE PHOTO	Changes the default setting of fax resolution.	6-5	
		3. DELAYED TIMER	00:00	Sets the time of day that delayed faxes will be sent.	6-9	
		4. DELAYED FAX	—	Sends documents later.	6-10	
		5. BATCH TX	ON OFF	Sends all delayed faxes that are to the same fax number and at the same time as one transmission.	6-10	
		6. REAL TIME TX	NEXT FAX ONLY ON OFF	You can send a fax without using memory.	6-3	
		7. POLLED TX	ON OFF	Sets up your machine with a document to be retrieved by another fax machine.	6-11	
		8. COVERPG SETUP	NEXT FAX ONLY ON OFF PRINT SAMPLE	Automatically sends a cover page you program.	6-6	
		9. COVERPAGE MSG	—	Programs customized message for fax cover page.	6-7	



The factory setting (option) is shown in bold.

Main Menu	Submenu	Menu Selections	Options	Descriptions	Page	
2. FAX (continued)	2. SETUP SEND (continued)	0. OVERSEAS MODE	ON	Adjusts for sometimes difficult overseas transmissions.	6-9	
			OFF			
	3. SET AUTO DIAL	1. ONE-TOUCH DIAL	—	Store One-Touch numbers so you can dial by pressing only one key (and Fax Start).	7-1	
			2. SPEED-DIAL	—	Store 200 Speed Dial numbers so you can dial by pressing only four keys (and Fax Start).	7-2
				3. SETUP GROUPS	—	Sets up a Group number for Broadcasting.
	4. SETUP REPORTS	1. TRANSMISSION	ON ON+IMAGE OFF OFF+IMAGE	Initial setup for Transmission Verification Report and FAX Activity Report.	10-1	
			2. ACT. INTERVAL		EVERY 50 FAXES 6/12/24 Hours 2/7 Days OFF	10-1
	5. REMOTE FAX OPT	1. FAX FWD/PAGING	OFF FAX FORWARD PAGING	Sets the machine to forward fax messages— OR —to call your pager.	9-1	
			2. FAX STORAGE	ON	Stores incoming faxes in memory for remote retrieval.	9-3
				OFF		
			3. REMOTE ACCESS	159 *	Personalizes code for retrieving faxes.	9-3
			4. PRINT FAX	—	Prints incoming faxes stored in the memory.	5-6
	5. BACKUP PRINT	ON	Prints a copy of faxes as they are received into memory.	9-3		
		OFF				
	6. REMAINING JOBS	—	—	Checks which jobs are in memory or cancel a delayed fax or polling job.	5-8, 6-4	



The factory setting (option) is shown in bold.

Main Menu	Submenu	Menu Selections	Options	Descriptions	Page
2. FAX (continued)	0. MISCELLANEOUS	1. DISTINCTIVE	ON OFF SET	Uses the telephone company Distinctive Ring subscriber service to register the ring pattern with the machine.	8-1
		2. CALLER ID	DISPLAY# PRINT REPORT	View or print a list of the last 30 Caller IDs stored in memory.	8-3
		3. DRUM LIFE	—	You can check the percentage of drum life that remains available.	19-24
		4. MEM SECURITY	—	Stops most operations except receiving faxes into memory.	5-6
3. COPY	1. COPY MODE	—	AUTO TEXT PHOTO	Selects the Copy resolution for your type of original.	11-7
	2. CONTRAST	—	- ■ ■ ■ □ □ +	Adjusts the contrast.	11-8
	3. PAPER TYPE	—	THIN PLAIN THICK THICKER	Identify the type of paper in the multi-purpose sheet feeder.	11-8
	These settings appear if Cassette #2 was installed and set to ON.	CASSETTE #1	THIN PLAIN THICK THICKER		
		CASSETTE #2	THIN PLAIN THICK THICKER		
4. PRINTER (Only for FAX-5750e)	1. PRINT OPTIONS	1. INTERNAL FONT	—	You can print resident fonts to check and confirm font types.	
		2. CONFIGURATION	—	Printer settings and status are listed here.	
	2. RESET PRINTER	—	—	You can restore the printer back to the factory default settings.	
4. LAN (Option for FAX-4750e.) 5. LAN (For FAX-5750e.)					See the NC-8100h Owner's manual on the CD-ROM.



The factory setting (option) is shown in bold.

4 Initial Setup

Getting Started



Setting Paper Size



You can use three sizes of paper for printing your faxes: letter, legal and A4. When you change the size of paper you have loaded in the machine, you will need to change the setting for the paper size, so your machine will know how to fit the incoming fax on the page.

After you connect the optional Cassette #2, you can select the paper size for each cassette. (See *Turning on Cassette #2 (Option for FAX-4750e)*)

- 1 Press **Menu, 1, 1.**

1.PAPER SIZE

- 2 If you have the **Cassette #2**, press  or  to select **CASSETTE #1** or **CASSETTE #2**, and then press **Set**.

- 3 Press  or  to select **LETTER**, **LEGAL** or **A4** (for the cassette you selected in Step 2), and then press **Set**.



- 4 Press **Stop/Exit**.

Turning on Cassette #2 (Option for FAX-4750e)

When the optional **CASSETTE #2** is set to **ON**, you can set paper size and the cassette usage. (See *Printing a Reduced Incoming Document*, Page 5-3 and *Setting Paper Size* above.)

- 1 Press **Menu, 1, 5.**

5.CASSETTE #2

- 2 Use  or  to select **ON** (or **OFF**), and then press **Set**.

- 3 Press **Stop/Exit**.



Setting Cassette Usage

The default setting of **AUTO** allows your machine to choose the optional Cassette #2 if paper is out in Cassette #1 or if incoming faxes will fit best on the paper in Cassette #2. Choose **CASSETTE#1 ONLY**, **CASSETTE#2 ONLY** or **AUTO** if you want to keep special paper in the other cassette and control when it is used.

- 1 Press **Menu**, **1**, **1**.
- 2 Press \leftarrow or \rightarrow to select **CASSETTE USAGE**, and then press **Set**.
- 3 To set cassette usage for faxes, press \leftarrow or \rightarrow to select **FOR FAX**, and then press **Set**.
—OR— To set cassette usage for copies, press \leftarrow or \rightarrow to select **FOR COPY**, and then press **Set**.
—OR— If you are finished go to Step 5.
- 4 Press \leftarrow or \rightarrow to select **AUTO**, **CASSETTE#1 ONLY** or **CASSETTE#2 ONLY**, and then press **Set**.
- 5 Press **Stop/Exit**.

Setting Date and Time

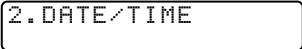
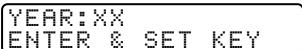
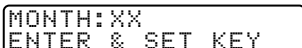
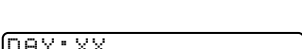
Your machine displays the date and time, and prints it on every fax you send. In the event of a power failure, you may have to reset the date and time. All other settings remain unaffected.

- 1 Press **Menu**, **1**, **2**.

- 2 Enter the last two digits of the year, and then press **Set**.

- 3 Enter two digits for the month and press **Set**. (For example, enter 09 for September, or 10 for October).

- 4 Enter two digits for the day, and then press **Set**. (For example, 06).

- 5 Enter the time in 24-hour format, and then press **Set**. (For example, enter 15:25 for 3:25 PM).

- 6 Press **Stop/Exit**.
The screen now shows the date and time you set whenever the machine is in standby mode.

Setting Station ID

You should store your name or (company name) and fax number to be printed on all fax pages you send. The telephone number you enter will be printed only on your cover pages and call back messages. (See *Composing Electronic Cover Page*, Page 6-6.)

- 1** Press **Menu, 1, 3**.

3. STATION ID

- 2** Enter your fax number (up to 20 digits), and then press **Set**. You must enter a fax number to proceed.

FAX:
ENTER & SET KEY

- 3** Enter your telephone number (up to 20 digits), and then press **Set**.
If your telephone number and fax number are the same, enter the same number again. The number appears on Cover pages.

TEL:
ENTER & SET KEY

- 4** Use the dial pad to enter your name (up to 20 characters), and then press **Set**.
(See Entering Text.)

NAME:
ENTER & SET KEY

- 5** Press **Stop/Exit**.
The LCD returns to the date and time.



If your Station ID has already been programmed, the LCD prompts “1” to make a change, or “2” to exit without changing.

NOTICE

The Telephone Consumer Protection Act of 1991 makes it unlawful for any person to use a computer or electronic device to send any message via a telephone machine unless such messages clearly contain, in a margin at the top or bottom of each transmitted page, or on the first page of the transmission, the date and time it is sent and an identification of the business or other entity or other individual sending the message and the telephone number of the sending machines or such business, other entity, or individual.

In order to program this information into your machine, you should complete the steps described on pages 4-2 and 4-3.

Entering Text

When you are setting certain functions, such as the Station ID, you may need to type text into the machine. Most keys on the dial pad have three or four letters printed above them. The keys for 0, # and * don't have printed letters because they are used for special characters.

By pressing the appropriate number key repeatedly you can access the character you want.

Key	once	twice	three times	four times	five times
2	A	B	C	2	A
3	D	E	F	3	D
4	G	H	I	4	G
5	J	K	L	5	J
6	M	N	O	6	M
7	P	Q	R	S	7
8	T	U	V	8	T
9	W	X	Y	Z	9

Inserting Spaces

If you want to enter a blank space, press  once between numbers and twice between characters.

Making Corrections

If you entered a letter incorrectly and want to change it, press  to move the cursor after the last correct letter. Then press **Clear**; all letters above and to the right of the cursor will be deleted. Re-enter the correct characters. Also, you can back up and type over incorrect letters.

Repeating Letters

If you need to enter a character that is assigned to the same key as the previous character, press  to move the cursor to the right.

Special Characters and Symbols

Press * for (space) ! “ # \$ % & ’ () * + , - . /

Press # for ; < = > ? @ [] ^ _

Press 0 for É À È Ê Î Ç Ë Ö 0

Setting the Ring Volume

- 1 Press **Menu, 1, 4, 1.**
- 2 Press **←** or **→** to select (**OFF, LOW, MED, or HIGH**) and press **Set.**
- 3 Press **Stop/Exit.**

1. RING

—OR—

You can adjust the ring volume when your machine is idle. You can turn the ring **OFF** or you can select a ring volume level.

Press **High** or **Low** to adjust the volume level. With each key press, your machine rings so you can hear the active setting as the LCD shows it. Each key press changes the volume to the next setting. The new setting will remain until you change it again.

Setting the Beeper Volume

You can set the beeper to **LOW, HIGH** or **OFF**. The default setting is **LOW**. When the beeper is set to **LOW** or **HIGH**, the machine beeps every time you press a key or make an error and when fax sending or receiving is finished.

- 1 Press **Menu, 1, 4, 2.**
- 2 Press **←** or **→** to select your setting.
- 3 When the LCD shows the setting you want, press **Set.**
- 4 Press **Stop/Exit.**

Setting the Speaker Volume

- 1 Press **Menu, 1, 4, 3.**
- 2 Press **←** or **→** to select your setting (**LOW, MED, HIGH** or **OFF**), and then press **Set.**
- 3 Press **Stop/Exit.**



3. SPEAKER

—OR—

If you are using **Hook**, you can adjust the speaker volume while dialing. You can turn the speaker off or you can select a speaker volume level. The default setting is the lowest volume.

Press **High** or **Low** to adjust the volume level. With each key press, the volume changes as the LCD shows the active setting. The new setting will remain until you change it again.

Setting the Handset Volume

- 1 Press **Menu**, **1**, **4**, **4**.
- 2 Press  or  to select your setting (**LOW** or **HIGH**), and then press **Set**.
The default setting is **LOW**.

4. HANDSET

- 3 Press **Stop/Exit**.
—OR—

Any time you are talking on the telephone, you can adjust the handset volume by pressing the volume **High** or **Low** keys on the control panel. The LCD shows the setting you are choosing.

The new setting will remain until you change it again.

Choosing the Handset Volume (For Volume Amplify)

Before you begin to use the machine, you must decide if you need to set the handset volume to **AMPLIFY:ON** for a user who is hearing-impaired. The **AMPLIFY:ON** volume level complies with FCC standards.

VOLUME AMPLIFY: OFF

This default setting is appropriate if *none* of the users are hearing-impaired. During a conversation, users can press Volume **High** or **Low** on the control panel to adjust the volume to **LOW** or **HIGH**. When the handset is replaced, the handset volume will remain until you change it again.

VOLUME AMPLIFY: ON—TEMPORARY

This setting is appropriate if *some* of the users are hearing-impaired. During a conversation, users can press Volume **High** or **Low** on the control panel to adjust the volume to **LOW**, **HIGH** or **AMPLIFY**. When the handset is replaced, the handset volume returns to the default setting of **LOW**.

VOLUME AMPLIFY: ON—PERMANENT

Choose **VOL AMPLIFY:ON—PERMANENT** if *all* of the users are hearing-impaired. During a conversation, users can press Volume **High** or **Low** on the control panel to adjust the volume to **LOW**, **HIGH** or **AMPLIFY**. When the handset is replaced, the handset volume returns to the default setting of **AMPLIFY**.



When you press Volume **High** or **Low** on the control panel to adjust the volume, the display shows the setting you are choosing. Each key press changes the volume to the next setting.



WARNING

It is important that you do *not* choose **PERMANENT** unless all the users are hearing-impaired. Otherwise, the default setting of **AMPLIFY** may damage the hearing of some users.

Setting Volume Amplify (For the Hearing-Impaired)

Please carefully read *Choosing the Handset Volume (For Volume Amplify)*, on page 4-6 before you do the following steps:

1 Press **Menu, 1, 4, 5.**

```
5.VOLUME AMPLIFY
```

2 If *none* of the users are hearing-impaired, press **←** or **→** to select

VOL AMPLIFY:OFF? and then press **Set**, and then go to Step 4—**OR**—

If *some* or *all* of the users are hearing-impaired, select **VOL AMPLIFY:ON?** and then press **Set**.

```
VOL AMPLIFY:ON?  
SELECT ← → & SET
```

3 If *all* the users are hearing-impaired, press **←** or **→** to select

PERMANENT? and then press **Set**

—**OR**—If only *some* of the users are hearing-impaired, select

TEMPORARY? and then press **Set**.

```
PERMANENT?  
SELECT ← → & SET
```

```
TEMPORARY?  
SELECT ← → & SET
```

4 Press **Stop/Exit**.

Memory Storage

In the event of a power failure, all menu settings are stored permanently:

GENERAL SETUP, SETUP RECEIVE, SET AUTO DIAL, REMOTE FAX OPT plus the **COVERPG SETUP** and **COVERPG MSG** (from **SETUP SEND**). You may have to reset the date and time.

FAX-4750e and FAX-5750e have a Memory Backup feature;

after a power failure all faxes in memory will be saved for several days.

Turning On Automatic Daylight Savings Time

You can set the machine to change automatically for Daylight Savings Time.

It will reset itself forward one hour in the Spring and back one hour in the Fall.

1 Press **Menu, 1, 6.**



```
6.AUTO DAYLIGHT
```

2 Press **←** or **→** to select **ON** (or **OFF**), and then press **Set**.

3 Press **Stop/Exit**.

Toner Save

You can conserve toner using this feature. When you set Toner Save to **ON**, print appears somewhat lighter. The default setting is **OFF**.

- 1 Press **Menu, 1, 7**.
- 2 Press  or  to select **ON** (or **OFF**), and then press **Set**.
- 3 Press **Stop/Exit**.

7. TONER SAVE

Sleep Mode

Setting the Sleep Mode reduces power consumption while the machine is idle. You can choose how long the machine is idle (from 00 to 99 minutes) before it drops into sleep mode. The timer automatically resets itself after the machine receives a fax or PC data, or makes a copy. The default setting is 5 minutes.



- 1 Press **Menu, 1, 8**.
- 2 Use the Dial pad to enter the length of time the machine is idle before it drops into sleep mode (00 to 99 minutes), and then press **Set**.
- 3 Press **Stop/Exit**.

8. SLEEP MODE

Setting Tone/Pulse Dialing Mode

Your fax machine comes set to accommodate tone (multi-frequency) dialing service.

If you have pulse (rotary) dialing service, you need to change the dialing mode.

- 1 Press **Menu, 1, 9**.
- 2 Press  or  to select **TONE** or **PULSE** and then press **Set**.
- 3 Press **Stop/Exit**.

9. TONE/PULSE



5 Setup Receive

Basic Receiving Operations

Select Your Receive Mode

There are four different receive modes for your machine. You may choose the mode that best suits your needs by pressing the **Mode** button repeatedly until you have changed the FAX and FAX/TEL lights to the setting you want to use.

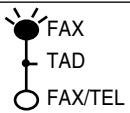

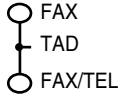
NOTE: The lighted indicators mean ○ = not selected ☼ = is selected and lit.

Mode	Light	How it works	When to use it
FAX (automatic receive)		The machine automatically answers every call as a fax.	For dedicated fax lines. You cannot receive a voice call but you can call out.
TAD (External Telephone Answering Device)		The external TAD automatically answers every call. Voice messages are stored on the external TAD. Fax messages are printed.	Use this mode if you have an answering machine on your phone line.
FAX/TEL* (fax and telephone)		The machine controls the line and automatically answers every call. If the call is a fax it will receive the fax. If the call is not a fax it will ring (double-ring) for you to pick up the call.	You cannot have an answering machine on the same line, even if it is on a separate jack on the same line. You cannot use the telephone company's Voice Mail in this mode.
MANUAL (manual receive)		You control the phone line and must answer every call yourself.	Use this mode when you are using a computer modem on the same line or if you receive very few fax messages. You can also use this mode with Distinctive Ring.

*In FAX/TEL mode you must set the Ring Delay and F/T Ring Time. If you have extension phones on the line, set the Ring Delay to 4 rings.

Setting Ring Delay



The Ring Delay setting determines the number of times the machine rings before it answers. If you have extension phones on the same line as the machine, keep the Ring Delay default setting of **4**. (See *Easy Receive*, Page 5-3 and *Operation from Extension Telephone or External Telephone* and *For FAX/TEL Mode Only*, Page 5-5.)

- 1 Press **Menu, 2, 1, 1**.
- 2 Press  or  to select how many times the line rings before the machine answers (00 – 04), and then press **Set**. (If you select 00, the line doesn't ring at all.)
- 3 Press **Stop/Exit**.

1. RING DELAY

Setting F/T Ring Time (For FAX/TEL Mode Only)

If you set the receive mode to FAX/TEL, you'll need to determine how long the machine will send you its special double-ring when you have a voice call. This ringing happens *after* the initial ringing from the phone company. Only the machine rings, for 20, 30, 40 or 70 seconds; no other phones on the same line ring the special double-ring. However, you can answer the call on any extension phone (in a separate wall jack) on the same line as the machine. (See *Operation from Extension Telephone*, page 5-5.)

- 1 Press **Menu, 2, 1, 2**.
- 2 Press  or  to select how long the machine will ring to alert you that you have a voice call, and then press **Set**.
- 3 Press **Stop/Exit**.

2. F/T RING TIME

RING TIME: 20 SEC
SELECT ← → & SET

Now, when a call comes in and the machine is set to FAX/TEL mode, all phones on this line will ring the number of times you selected in Ring Delay.

You can let the machine pick up and detect if it's a fax or voice call. If it's a fax call, the machine prints the fax. If it's a voice call, the machine signals you with a double-ring for the length of time you selected in F/T Ring Time.



Even if the caller hangs up during the double-ringing, the machine continues for the set time.

Easy Receive

When you use this feature, you don't have to press **Fax Start** when you answer a fax call and hear calling beeps. Just hold the handset and wait a few seconds. When you see **RECEIVING** on the LCD or when you hear "chirps" through the handset of an extension phone connected to another wall jack, just replace the handset. Your machine does the rest. Selecting **ON** allows the machine to receive fax calls automatically, even if you lift the handset of an extension or external phone. Selecting **SEMI** lets the machine receive the call only if you've answered it at the Brother machine. Selecting **OFF** means you'll have to activate the machine yourself, by pressing **Fax Start**—**OR**—by pressing *** 5 1** if you are not at the machine.

If you've set this feature to **ON**, but your machine doesn't automatically connect a fax call when you lift an external or extension phone handset, press the Fax Receive code *** 5 1**. At the machine, lift the handset and then press **Fax Start**. (See *Operation from Extension Telephone or External Telephone* and *For FAX/TEL Mode Only*, Page 5-5.)



If you send faxes from a computer on the same phone line and your Brother machine intercepts them, set Easy Receive to **OFF**.

- 1 Press **Menu, 2, 1, 3**.
- 2 Use or to select **ON, SEMI** or **OFF**, and then press **Set**.
- 3 Press **Stop/Exit**.

3.EASY RECEIVE

Printing a Reduced Incoming Document

Your machine can reduce the size of an incoming fax to fit the size of the paper in your machine. Select **ON** to turn on this feature.

After you connect Cassette #2, you can turn on Automatic Reduction for each cassette. (See *Turning on Cassette #2 (Option for FAX-4750e)*, Page 4-1)

- 1 Press **Menu, 2, 1, 5**.
- 2 If you have the optional Cassette #2, press or to select **CASSETTE #1** or **CASSETTE #2**, and then press **Set**.
- 3 Use or to select **ON** (or **OFF**), and then press **Set**.
- 4 Press **Stop/Exit**.



5.AUTO REDUCTION



Cassette #2 can be purchased.

Setting the Print Density

If your machine is printing too light or too dark, you can adjust print density, making your printed documents darker or lighter. The new setting will remain until you change it again.

- 1** Press **Menu, 2, 1, 6**.
- 2** Press  to make print lighter, or  to make print darker.
- 3** Press **Stop/Exit**.

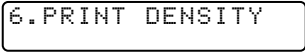

6.PRINT DENSITY

Advanced Receiving Operations

Operation from Extension Telephone or External Telephone

If you answer a fax call on an extension phone (or on an external phone in the EXT. jack), you can make your machine take over by using the Fax Receive Code. When you press the Fax Receive Code *** 5 1**, the machine starts to receive a fax. (See *Setting Ring Delay*, Page 5-2 and *Easy Receive*, Page 5-3.)

If the machine answers a voice call and double-rings for you to take over, use the Telephone Answer Code **# 5 1** to take the call at an extension phone.

If you answer a call, and no one is on the line, assume you're receiving a fax. At the machine's phone, press **Fax Start**, then hang up. At an extension phone, press *** 5 1**, wait for fax receiving tones (chirps), then hang up. At an external phone, press *** 5 1** and wait for the phone to be disconnected (the LCD shows **RECEIVING**) before you hang up. (Your caller will have to press **Fax Start** to send the fax.)

For FAX/TEL Mode Only

When the machine is in FAX/TEL mode, it will use the F/T Ring Time (double-ringing) to alert you to pick up a voice call. If you're at the machine, you can lift the handset to answer.

If you're at an extension phone, you'll need to lift the handset during the F/T Ring Time and then press **# 5 1** between the double rings. If no one is on the line, or if someone wants to send you a fax, send the call back to the machine by pressing *** 5 1**.

Changing Remote Codes

Remote Codes might not work with some telephone systems. The preset Fax Receive Code is *** 5 1**. The preset Telephone Answer Code is **# 5 1**.



If you are always disconnected when accessing your external TAD remotely, try changing the Fax Receive Code from *** 5 1** to **# # #** and the Telephone Answer Code from **# 5 1** to **9 9 9**.

- 1 Press **Menu, 2, 1, 4**.
- 2 Press **←** or **→** to select **ON** (or **OFF**) and then press **Set**.
- 3 If you want to, type a new Fax Receive Code, and then press **Set**.
- 4 If you want to, type a new Telephone Answer Code, and then press **Set**.
- 5 Press **Stop/Exit**.

4.REMOTE CODE

FAX RECEIVE:*51
ENTER & SET KEY

TEL ANSWER:#51
ENTER & SET KEY

Printing a Fax in Memory

If you have Fax Storage ON for Remote Retrieval you can still print a fax in the memory when you are at your machine. (See *Setting Fax Storage*, Page 9-3.)

- 1 Press **Menu**, **2**, **5**, **4**.
- 2 Press **Fax Start**.
- 3 After printing is finished, and then press **Stop/Exit**.

4. PRINT FAX

Memory Security

Memory Security lets you prevent unauthorized access to the machine. The machine will not send faxes or print received faxes without the password. You cannot continue to schedule Delayed Faxes or Polling jobs. However, any pre-scheduled Delayed Faxes will be sent when you turn Memory Security ON so they won't be lost.

If Fax Storage is ON *before* you turn Memory Security ON, then Fax Forwarding and Remote Retrieval will continue to work.

While Memory Security is ON the following operations are available:

- Receiving faxes into memory (limited by memory capacity)
- Fax Forwarding (If Fax Storage was already ON)
- Remote Retrieval





To print the faxes in memory, turn Memory Security OFF.

Setting Up the Password

- 1 Press **Menu**, **2**, **0**, **4**.
- 2 Enter a 4-digit number for the password, and then press **Set**.
If you are entering the password for the first time, the LCD shows **VERIFY**.
- 3 Re-enter the password, and then press **Set**.

Turning Memory Security ON

- 1 Press  or  to select **SET SECURITY**, and then press **Set**.
- 2 Enter the registered 4-digit password, and then press **Set**.
The machine goes OFFLINE and the LCD shows **SECURE MODE**.

Turning Memory Security OFF

- 1 Press **Menu**, and then enter the registered 4-digit password. Memory Security is automatically turned off and the LCD shows the Date and Time.



If you enter the wrong Password, the LCD shows **WRONG PASSWORD** and stays **OFFLINE**. The machine will stay in Secure Mode until the registered password is entered.

Polling

Polling is the process of retrieving faxes from another fax machine. You can use your machine to “poll” other machines, or you can have someone poll your machine.

All parties involved in polling need to set up their fax machines to accommodate polling. When someone polls your machine to receive a fax, they pay for the call; if you poll someone’s fax machine to receive a fax, you pay for the call.



Some fax machines do not respond to the polling function.

Setting Up Polling Receive

Polling Receive is when you call another fax machine to receive a fax from it. (See *Canceling a Scheduled Job*, Page 5-8.)

- 1 Press **Menu, 2, 1, 7**.
- 2 Press **←** or **→** to choose **ON** (or **OFF**), and then press **Set**.
- 3 Enter the fax number you are polling.
- 4 Press **Fax Start**. The LCD shows **DIALING**.

7. POLLING RX

POLLING RX: OFF?
SELECT ← → & SET



ENTER FAX NO.
PRESS FAX START

Setting Up Sequential Polling Receive

Your machine can request documents from several fax units in a single operation. Afterward, a Sequential Polling Report will be printed. (See *Canceling a Scheduled Job*, Page 5-8.)

- 1 Press **Menu, 2, 1, 7.**

7. POLLING RX

- 2 Press  or  to select Polling **ON** (or **OFF**), and then press **Set**.

POLLING RX: OFF?
SELECT   & SET

- 3 Specify the destination fax machines you wish to poll using One Touch, Speed Dial, a Group or the dial pad. You must press **Broadcast** between each location.

ENTER FAX NO.
PRESS FAX START

- 4 Press **Fax Start**.

The LCD shows **DIALING**.

Your machine will poll each number or group member in turn for a document.



Canceling a Scheduled Job

You can cancel tasks you've scheduled, such as Delayed Fax, Polling Receive, Polling Transmit or faxes in memory waiting to be sent.

- 1 Press **Menu, 2, 6.**

6. REMAINING JOBS

Any waiting jobs will appear on the LCD. If no jobs are waiting, the LCD shows **NO JOB WAITING**.

- 2 If you have more than two jobs waiting, use  or  to select the job you want to cancel, and then press **Set**.

—OR—

If you have only one job waiting, go to Step 3.

- 3 Press **1** to cancel—OR—Press **2** to exit without canceling. To cancel another job, return to Step 2.

- 4 Press **Stop/Exit**.



You can check which jobs are waiting in memory by following Steps 1 and 2 above.

6 Setup Send

Before You Begin

Before you begin sending faxes, please be sure to read all the instructions and cautions listed below for placing originals in the automatic document feeder.

Using the ADF (Automatic Document Feeder)

- Documents must be between 5.8 and 8.5 inches wide between 3.9 and 14.1 inches long. Your machine can scan an image only 8.15 inches wide, regardless of how wide the paper is.
- Fan the pages before placing them in the ADF.
- Make sure you insert documents **face down, top edge first**.
- Adjust the paper guides to fit the width of your document.
- The **ADF** (automatic document feeder) can hold up to 30 Pages, feeding each one individually through the machine. If you “Stagger” the pages, the ADF can hold up to 50 pages. Use standard (17 lb–24 lb) paper when using the ADF. If you’re using heavier paper, feed each sheet individually to prevent paper jams.

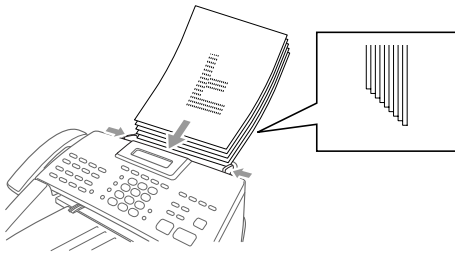
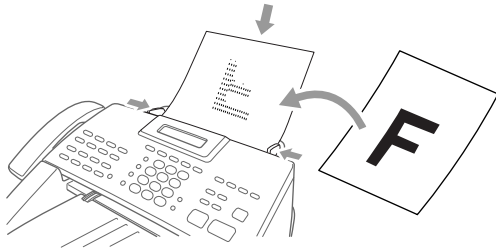

- ⊘ **DO NOT** use curled, wrinkled, folded or ripped paper, or paper with staples, paper clips, paste or tape attached. **DO NOT** use cardboard, newspaper or fabric.
- Make sure documents written in ink are completely dry.
- Before you send a fax press **Resolution** to select the resolution for the document you’re sending. (See *Fax Resolution*, Page 6-5.)



If you send faxes from a computer on the same phone line and your Brother machine intercepts them, set Easy Receive to OFF.

Sending Faxes with Multiple Settings

When you send a fax you can choose any combination of these settings: add a coverage page and select a comment; set the contrast or resolution; send using overseas mode, call reservation or delayed fax timer, polling transmission or real time transmission. After each menu selection is accepted, the LCD will ask if you want to enter other settings:

ACCEPTED

OTHER SETTINGS?
1.YES 2.NO

Press **1** if you want to select additional settings. The LCD returns to the **SETUP SEND** menu—**OR**—

Press **2** if you are finished choosing settings, and then go to the next step.

Manual Transmission

Manual transmission lets you hear the dial tone, ringing and fax receiving tones while sending a fax.

- 1** Place the original face down in the ADF.
- 2** Pick up the handset and listen for a dial tone—**OR**—
Press **Hook** and listen for a dial tone.
- 3** Dial the fax number you want to call (you can enter the digits using the dial pad, or you can enter a One Touch or Speed Dial number or you can call from the Search).
(See *One Touch Dialing*, Page 7-5.)
- 4** When you hear the fax tone, press **Fax Start**.
- 5** If you're using the handset, hang up.

Automatic Transmission

This is the easiest way to send a fax. **IMPORTANT:** Do **not** pick up the handset, or press **Hook** to listen for a dial tone.

- 1** Place the original face down in the ADF.
- 2** Enter the fax number using One Touch, Speed Dial, Search or the dial pad. (See *Speed Dialing*, Page 7-5.)
- 3** Press **Fax Start**.

Manual and Automatic Fax Redial

If you're sending a fax manually and the line is busy, after you disconnect the call press **Redial/Pause** to retry the number.

If you're sending a fax automatically and the line is busy, the machine will redial automatically redial (up to three times at 5 minute intervals).

Dual Access

You can scan *up* to 50 documents into the fax memory, even while the machine is receiving or sending another fax (from memory). You can set temporary settings for each fax you're scanning, except Timer and Polling.

If you try to scan and store a 51st fax, the machine will send it immediately, without storing it in memory.



If you get a **OUT OF MEMORY** message while scanning the first page of a fax, press **Stop/Exit** to cancel scanning. If you get a **OUT OF MEMORY** message while scanning in a subsequent page, you'll have the option to press **Fax Start** to transmit the pages scanned so far, or to press **Stop/Exit** to cancel the operation.

- 1 Place the original face down in the ADF.
- 2 Enter the fax number.
- 3 Press **Fax Start**. As the machine scans the original, the LCD shows the job number (#XXX) of the fax and how much memory is available. Then the machine starts dialing. You can immediately repeat Steps 1 to 3 for the next fax.



Your machine normally operates in Dual Access mode. However, you can override Dual Access by using Real Time Transmission.



The number of documents you can scan into memory varies with the data they contain.

Real Time Transmission



When you are sending a fax, the machine will scan originals into memory before sending. Then, as soon as the phone line is free, the machine will start dialing and sending the fax. If memory becomes full, the machine will send the document in real time (even if **REAL TIME TX** is set to **OFF**).

Sometimes you may want to send an important document immediately, without waiting for memory transmission. You can set **REAL TIME TX** to **ON**.

- 1 Place the original face down in the ADF.
 - 2 Press **Menu, 2, 2, 6**.
6. REAL TIME TX
- 3 To change the default setting, and then press or to select **ON** (or **OFF**) and then press **Set**. Go to Step 5—**OR**—For the next fax transmission only, press or to select **NEXT FAX ONLY**, and then press **Set**.
 - 4 For the next fax only, press or to select **ON** (or **OFF**), and then press **Set**.
 - 5 Press **1** if you want to select additional settings. The LCD returns to the **SETUP SEND** menu—**OR**—Press **2** if you are finished choosing settings, and then go to Step 6.
 - 6 Enter fax number and then press **Fax Start**.

Checking the Jobs Status

Check which jobs are still waiting in memory to be sent. (If no jobs are waiting, the LCD shows **NO JOB WAITING.**) (*Canceling Jobs in Memory on this page.*)



- 1 Press **Menu, 2, 6.**
- 2 If you have multiple jobs waiting, use  or  to scroll through the list.
- 3 Press **Stop/Exit.**

Canceling a Job While Scanning the Original

You can cancel a job while you are scanning it into memory by pressing **Stop/Exit.** Eject the document by pressing **Stop/Exit** again.

Canceling Jobs in Memory

You can cancel tasks you've scheduled, such as Delayed Fax, Polling Receive, Polling Transmit or faxes in memory waiting to be sent.

- 1 Press **Menu, 2, 6.**
Any waiting jobs appear on the display.
If no jobs are waiting, the LCD shows **NO JOB WAITING.**
- 2 If you have more than two jobs waiting, use  or  to select the job you want to cancel, and then press **Set.**
—OR—
If you have only one job waiting, go to Step 3.
- 3 Press **1** to cancel—OR—Press **2** to exit without canceling. To cancel another job, return to Step 2.
- 4 Press **Stop/Exit.**

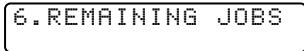

6.REMAINING JOBS





#002 SALES REPOR
1.CLEAR 2.EXIT

Basic Sending Operations

Contrast

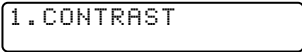
If your document is very light or very dark, you might want to set the contrast. Use **S.LIGHT** to send a very light document. Use **S.DARK** to send a very dark document.



- 1 Place the original face down in the ADF.
- 2 Press **Menu, 2, 2, 1**.

- 3 Use  or  to select **AUTO, S.LIGHT** or **S.DARK**, and then press **Set**.
- 4 Press **1** if you want to select additional settings. The LCD returns to the **SETUP SEND** menu—**OR**—Press **2** if you are finished choosing settings, and go to Step 5.
- 5 Enter a fax number, and then press **Fax Start** to send a fax.

Fax Resolution

When you have an original in the ADF, you can use the **Resolution** key to temporarily change the setting. Press **Resolution** repeatedly until the LCD shows the setting you want.

—**OR**—

You can change the default setting.

- 1 Press **Menu, 2, 2, 2**.

- 2 Press  or  to select the resolution you want, and then press **Set**.
- 3 Press **Stop/Exit**.

STANDARD—Suitable for most typed documents.

FINE—Good for small print; transmits a little slower than Standard resolution.

S. FINE—Good for small print or artwork; transmits slower than Fine resolution.

PHOTO—Use when original has varying shades of gray; slowest transmission time.

Composing Electronic Cover Page

The cover page is generated at the receiving party's machine. Your cover page includes the name stored in the One Touch or Speed Dial memory. If you're dialing manually, the name is left blank. (See *One Touch Dialing*, Page 7-5 and *Speed Dialing*, Page 7-5.)

The cover page indicates your Station ID, and the number of pages you're sending. If you have Cover Page Setup set to ON, the number of pages remains blank. (**Menu, 2, 2, 8.**) (See *Setting Station ID*, Page 4-3.)

You can select a comment to include on your cover page.

1. COMMENT OFF

2. PLEASE CALL

3. URGENT

4. CONFIDENTIAL

Instead of using one of the comments above, you can enter up to two customized messages, each 27 characters long. Use the chart on Page 4-4 to help enter characters. (See *Composing Your Own Comments*, Page 6-7.)



5. <USER DEFINED>

6. <USER DEFINED>

Most of the **SETUP SEND** menu selections are temporary settings that allow you to make adjustments for each document you send. However, so you can set up your cover page and cover page comments in advance, the Cover Page Setup and Cover Page Message menu selections change the default settings.

Composing Your Own Comments

You can set up two custom comments.

- 1 Press **Menu, 2, 2, 9**.
- 2 Use  or  to choose position 5 or 6 for your customized comment and then press **Set**.
- 3 Use the dial pad to enter your customized comment, and then press **Set**.
(See *Entering Text*, Page 4-4.)
- 4 Press **1** if you want to select additional settings. The LCD returns to the **SETUP SEND** menu—**OR**—Press **2** to exit.

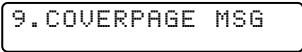

9. COVERPAGE MSG



ACCEPTED

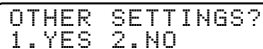





OTHER SETTINGS?
1.YES 2.NO

Cover Page for the Next Fax Only

Make sure the Station ID is set up. (See Page 4-4.) This feature does not work without the Station ID.

You can set the fax to send a cover page with a particular document. This cover page will include the number of pages in your document.

- 1 Place the original face down in the ADF.
- 2 Press **Menu, 2, 2, 8**.
- 3 When the LCD shows **NEXT FAX ONLY**, and then press **Set**.
- 4 Press  or  to select **ON** (or **OFF**), and then press **Set**.
- 5 Press  or  to select one of the standard or custom comments, and then press **Set**.
- 6 Enter two digits to indicate the number of pages you are sending, and then press **Set**. (For example, press **02** for 2.) (Enter **00** to leave the number of pages blank.) If you make a mistake, and then press  to back up and reenter the number of pages.
- 7 Press **1** if you want to select additional settings. The LCD returns to the **SETUP SEND** menu—**OR**—Press **2** if you are finished choosing settings, and then go to Step 8.
- 8 Enter the fax number you're calling.
- 9 Press **Fax Start**.

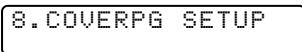

8. COVERPG SETUP

Always Send Cover Page

Make sure the Station ID is set up. This feature does not work without the Station ID. (See *Setting Station ID*, Page 4-3.)

You can set the machine to send a cover page whenever you send a fax. The number of pages in your fax is not included when you use this setting.

- 1** Press **Menu, 2, 2, 8**.

8. COVERPG SETUP

- 2** Press **←** or **→** to select **COVERPAGE: ON** and then press **Set**.

COVERPAGE: OFF?
SELECT ← → & SET

- 3** If you selected **ON**, press **←** or **→** to select one of the standard or custom comments, and then press **Set**.

COVERPAGE: ON?
SELECT ← → & SET

- 4** Press **1** if you want to select additional settings. The LCD returns to the **SETUP SEND** menu—**OR**—Press **2** to exit if you are finished choosing settings.

Using a Printed Cover Page

If you prefer using a printed cover page that you can write on, you can print the sample page and attach it to your fax.

- 1** Press **Menu, 2, 2, 8**.

- 2** Press **←** or **→** to select **PRINT SAMPLE**, and then press **Set**.

- 3** Press **Fax Start**. Your machine prints a copy of your cover page.

```
==== COVER PAGE ====

TO:      _____

FROM:    _____
        FAX:
        TEL:

                PAGE(S) TO FOLLOW

COMMENT:
```

Advanced Sending Operations

Overseas Mode

After you send a fax using this feature, the feature turns itself off.

- 1 Place the original face down in the ADF.
- 2 Press **Menu, 2, 2, 0**.
- 3 Press **←** or **→** to select **ON** (or **OFF**), and then press **Set**.

- 4 Press **1** if you want to select additional settings. The LCD returns to the **SETUP SEND** menu—**OR**—Press **2** if you are finished choosing settings and go to Step 5.
- 5 Enter the fax number you're calling.
- 6 Press **Fax Start**.

Delayed Timer

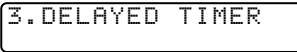
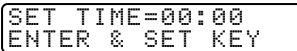
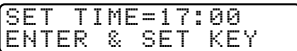
You can set up the time of day that delayed faxes will be sent. This time will be displayed for acceptance or you can override it in *Delayed Fax*.
(See *Delayed Fax*, Page 6-10.)

- 1 Press **Menu, 2, 2, 3**.

- 2 Enter the time (in 24-hour format) that you want delayed faxes to be sent, and then press **Set**.

- 3 Press **Stop/Exit**.

Delayed Fax

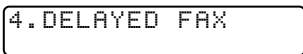
During the day you can store *up to* 50 documents into memory for delayed sending. Transmission of these documents will begin at the time of day you enter in Step 3. If you have set up in *Delayed Timer* on page 6-9, you can accept it in Step 3 or enter another time for this fax.

- 1 Place the original face down in the ADF.
- 2 Press **Menu, 2, 2, 4**.
- 3 Accept the displayed time or enter another time for this fax, and then press **Set**.
- 4 Press **1** to leave the originals waiting in the document feeder—**OR**—Press **2** to scan the document into memory.
- 5 Press **1** if you want to select additional settings. The LCD returns to the **SETUP SEND** menu—**OR**—Press **2** if you are finished choosing settings, and then go to Step 6. The screen will prompt you to enter the fax number.
- 6 Enter the fax number.
- 7 Press **Fax Start**. The machine will wait to send the fax at the time you set.



4.DELAYED FAX





1.DOC 2.MEMORY



The number of documents you can scan into memory varies with the data they contain.

Delayed Batch Transmission

Before sending the delayed faxes, your Brother machine will economize by sorting all the documents in memory by destination and scheduled time. All delayed faxes scheduled at the same time to the same fax number will be sent as one transmission.

- 1 Press **Menu, 2, 2, 5**.
- 2 Press  or  to select **ON** (or **OFF**), and then press **Set**.
- 3 Press **Stop/Exit**.

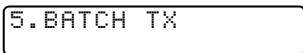

5.BATCH TX



BATCH TX:ON?
SELECT ← → & SET

Setting Up Polling Transmit

Polling Transmit is when you set up your machine to wait with a document so another fax machine can retrieve it.

1 Place the original face down in the ADF.

2 Press **Menu, 2, 2, 7.**

7. POLLED TX

3 Press **←** or **→** to choose **POLLED TX:ON**, and then press **Set.**

POLLED TX:OFF?
SELECT ← → & SET

4 Press **1** to leave the originals waiting in the document feeder—**OR**—Press **2** to scan the document into memory.

1. DOC 2. MEMORY

5 Press **1** if you want to select additional settings. The LCD returns to the **SETUP SEND** menu—**OR**—Press **2** if you are finished choosing settings and go to Step 6.

6 Press **Fax Start.**



If you pressed **1** in Step 4, the original remains in the ADF until your machine is polled. If you must use your machine before the polled transmit occurs, you must cancel this job.

POLLED REPORT

TIME : 04/01/2002 15:21
NAME : BROTHER
FAX : 908-XXX-XXXX
TEL : 908-XXX-XXXX

DATE, TIME	04/01 15:20
DURATION	00:00:23
PAGE(S)	01
RESULT	OK
MODE	STANDARD
	ECM

7

Auto Dial Numbers and Dialing Options

Storing Numbers for Easy Dialing

You can set up your machine to do three types of easy dialing: One Touch, Speed Dial, and Groups for Broadcasting of faxes. You can store names with these numbers for easy identification.



If you must wait for another dial tone at any point in the dialing sequence, store a pause at that point in the number by pressing **Redial/Pause**. Each key press adds a 3.5 second delay.



If you lose electrical power, auto dial numbers stored in memory will **not** be lost.

Storing One Touch Dial Numbers

You can store 32 fax/phone numbers that you can dial by pressing one key (and **Fax Start**). To access numbers 17 to 32, hold down the **Shift** key. When you press a One Touch dial location, the LCD shows the name or number as the call is dialed. (See *One Touch Dialing*, Page 7-5.)

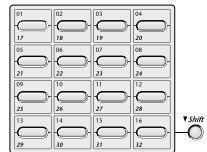

One Touch keys are the 16 keys (numbers 01–32) located on the left side of the control panel.



(For USA only) One-Touch key **1** has been pre-programmed for the Brother fax-back system.

1 Press **Menu**, **2**, **3**, **1**.

1. ONE-TOUCH DIAL

2 Press the One Touch key where you want to store a number.

The LCD shows the location you selected.

3 Enter a number (up to 20 digits) and then press **Set**.

(See *Changing One Touch and Speed Dial Numbers*, Page 7-2.)



If you want to enter a pause in the dialing sequence (for example, to access an outside line), press **Redial/Pause** as you're entering digits. A dash appears on the LCD, pressing **Redial/Pause** enters a 3.5 second pause when the number is dialed.



4 Use the dial pad to enter the name (up to 15 characters), and then press **Set**. You can use the chart on Page 4-4 to help you enter letters—**OR**—Press **Set** to store the number without a name.

NAME:
ENTER & SET KEY

5 Return to Step 2 to store another One-Touch number—**OR**—Press **Stop/Exit**. When you dial an auto dial number, the LCD shows the name you've stored, or if you haven't stored a name, the number you're stored.

Storing Speed Dial Numbers

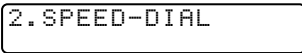

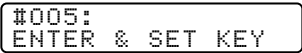
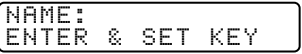
You can store Speed Dial numbers, so you can dial by pressing only six keys (**Search/Speed Dial**, **#**, and the Speed Dial location, and **Fax Start**). E-mail addresses can be stored in locations 01-100.

- 1 Press **Menu**, **2**, **3**, **2**.

- 2 Use the dial pad to enter a Speed Dial location, and then press **Set**. (01–200)

- 3 Enter the number (up to 20 digits) and then press **Set**.

- 4 Use the dial pad to enter the name (up to 15 characters), and then press **Set**.
You can use the chart on Page 4-4 to help you enter letters—**OR**—Press **Set** to store the number without a name.

- 5 Return to Step 2 to store another Speed Dial number—**OR**—Press **Stop/Exit**.

Changing One Touch and Speed Dial Numbers

If you try to store a One Touch or Speed Dial number in a location where a number is already stored, the LCD shows the current name stored at that location, then prompts you to either



- 1 Press **1** to change the number, or press **2** to exit without changing it.
- 2 Enter a new number and then press **Set**.
 - If you want to erase the number, press **Clear** when the cursor is to the left of the digits.
 - If you want to change a digit, use  or  to position the cursor under the digit you want to change, then type over it.
- 3 Follow the directions beginning at Step 4 for Storing One Touch Numbers or Storing Speed Dial Numbers.

Setting Up Groups for Broadcasting

Groups allow you to send the same fax message to many fax numbers by pressing only one One Touch Group key (and **Fax Start**). **First**, you'll need to store each fax number as a One Touch or Speed Dial number. **Then**, you can combine them into a Group. *Each Group uses up a One Touch key or a Speed Dial location.* Finally, you can have up to six small Groups, or you can assign up to 231 numbers to one large Group.

(See *Storing One Touch Dial Numbers*, Page 7-1 and *Storing Speed Dial Numbers*, Page 7-2.)

1 Press **Menu, 2, 3, 3**.

3.SETUP GROUPS

2 Select a One Touch key where you wish to store the Group number. (For example, press One Touch key **02** for Group 1.)

PRESS SPEED DIAL
OR ONE-TOUCH KEY

3 Use the dial pad to enter the Group number and then press **Set**. (For example, press **1** for Group 1.)

SETUP GROUP:GO
ENTER & SET KEY

4 To include One Touch or Speed Dial numbers in the Group, enter them as if you were dialing. For example, for One Touch key **05**, and then press One Touch key **05**. For Speed Dial location 09, press **Search/Speed Dial**, then press **0, 0, 9** on the dial pad. The LCD shows ***005, #009**.

G01:*005#009
ENTER & SET KEY

5 When you're finished adding numbers, and then press **Set**.

6 Use the dial pad and the chart on Page 4-4 to enter a name for the Group and then press **Set**. (For example, NEW CLIENTS)

NAME:
ENTER & SET KEY

7 Press **Stop/Exit**.



You can print a list of all One Touch and Speed Dial numbers. (See *Printing Reports*, Page 10-1.)

Dialing Options

You can use your machine to make voice telephone calls, by dialing manually, or by using Search, One Touch or Speed Dial memory. When you dial an auto dial number, the LCD shows the name you've stored, or, if you haven't stored a name, the fax number you've stored.

Manual Dialing

Manual dialing is simply pressing all of the digits of the phone number.

- 1 Pick up the handset—**OR**—Press **Hook**.
- 2 When you hear a dial tone, dial the call using the dial pad.
- 3 If you pressed **Hook** to dial the call, pick up the handset when the other party answers. (The speaker works only one way; the other party won't be able to hear you unless you pick up the handset.)
- 4 To hang up, replace the handset.

Search



You can search for names you have stored in One Touch and Speed Dial memories. Names are stored alphabetically. (See *Storing One Touch Dial Numbers*, Page 7-1 and *Storing Speed Dial Numbers*, Page 7-2.)

- 1 Press **Search/Speed Dial**, and then enter the first letter of the name you're looking for.
- 2 Press **←** or **→** to search the names that are stored alphabetically.
- 3 When the LCD shows the name you want to call, pick up the handset or press **Hook**.
- 4 Press **Fax Start** to begin dialing.
- 5 If you pressed **Hook** to dial the call, pick up the handset when the other party answers. (The speaker works only one way; the other party won't be able to hear you unless you pick up the handset.)
- 6 When the call is over, hang up.

Speed Dialing

- 1 Pick up the handset—**OR**—Press **Hook**.
(See *Storing Speed Dial Numbers*, Page 7-2.)
 - 2 When you hear a dial tone, press **Search/Speed Dial**, and then press # then the three-digit Speed Dial number.
 - 3 If you pressed **Hook** to dial the call, pick up the handset when the other party answers. (The speaker works only one way; the other party won't be able to hear you unless you pickup the handset.)
 - 4 To hang up, replace the handset.
-  If you are sending a fax, press **Fax Start** after pressing the Speed Dial number. If you picked up the handset, press **Fax Start** when the receiving fax machine answers with fax tones.

One Touch Dialing

- 1 Pick up the handset—**OR**—Press **Hook**.
 - 2 When you hear a dial tone, press the One Touch key of the location you want to call. (See *Storing One Touch Dial Numbers*, Page 7-1.)
-  To dial One Touch numbers 17 to 32, hold down **Shift** as you press the One Touch key.
- 3 If you pressed **Hook** to dial the call, pick up the handset when the other party answers. (The speaker works only one way; the other party won't be able to hear you unless you pickup the handset.)
 - 4 To hang up, replace the handset.
-  If you try to use a One Touch location with no number stored in it, you'll hear a warning sound, and screen will display **NOT REGISTERED**. The display will return to normal after 2 seconds.
-  If you are sending a fax, press **Fax Start** after pressing the One Touch key. If you picked up the handset, press **Fax Start** when the receiving fax machine answers with fax tones.

Broadcasting

Broadcasting is automatically sending the same fax message to multiple fax numbers. Using the **Broadcast** key, you can include Groups, One Touch locations, Speed Dial locations, plus up to 50 manually dialed numbers. However, available memory will vary with the types of jobs in memory and the number of locations used for broadcasting. If you broadcast to more than the maximum locations available, you will not be able to set up transmissions using dual access and the timer. (See *Setting Up Groups for Broadcasting*, Page 7-3.)

The easiest way to broadcast is to press Group keys, you can include One Touch, Speed Dial, and manually, dialed numbers in the same broadcast. You must press **Broadcast** between each of these locations. Use the Telephone Index to help you choose the numbers easily.

After the broadcast is completed, a Broadcast Report will be printed automatically to let you know the results.

- To stop the broadcasting in progress, press **Stop/Exit**. The LCD asks if you want to cancel all locations or the location that is being sent.
- Enter the long dialing sequence numbers as you normally would, but keep in mind that each key counts as one location, so the number of locations you can call become limited.
- If the line is busy or for some other reasons a connection could not be made while broadcasting, the machine will redial the number automatically.
- If the memory is full, press **Stop/Exit** to abort the job ; (if more than one page has been scanned) or press **Fax Start** to send the portion that is in the memory.

- 1 Place the original face down in the ADF.
- 2 Enter a number using One Touch, Speed Dial, Group number, Search or the dial pad.
Example: Group number
- 3 Press **Broadcast**. You will be prompted to press the next number.
- 4 Enter the next number. Example: Speed Dial number.
- 5 Press **Broadcast**.
- 6 Enter the next fax number.
Example: Manual dialing, using the dial pad
- 7 Press **Fax Start**.



Your machine will read the document into memory and then start sending faxes to all the numbers you entered.

Access Codes and Credit Card Numbers

Sometimes you may want to choose from among several long distance carriers when you make a call. Rates may vary depending upon the time and destination. To take advantage of low rates, you can store the access codes or long-distance carriers as One Touch and Speed Dial numbers. You can store these long dialing sequences by dividing them and setting them up separately in any combination. You can even include manual dialing using the dial pad. The combined number will be dialed in the order you entered it, as soon as you press **Fax Start**. (See *Storing One Touch Dial Numbers*, Page 7-1.)

For example, you store “555” on One Touch key **03** and “7000” on One Touch key **04**. If you press One Touch **03, 04** and **Fax Start** you can dial “555-7000”. To temporarily change a number, you can substitute part of the number with manual dialing using the dial pad. For example, to change the number to 555-7001 you could press One Touch **03** and then press **7, 0, 0, 1** using the dialing pad.



If you must wait for another dial tone at any point in the dialing sequence, store a pause at that point in the number by pressing **Redial/Pause**. Each key press adds a 3.5 second delay.

Pause

Press **Redial/Pause** to insert a 3.5 second pause between numbers. If you are dialing overseas, you can press **Redial/Pause** as many times as needed to increase the length of the pause.

Hold

- 1 Press **Hold** to place a call on Hold.
- 2 You can replace the handset without disconnecting the call.
- 3 Pick up the machine’s handset to release the call from Hold. Picking up an extension handset will not release the call from Hold.

Redial

If you’re sending a fax manually and the line is busy, press **Redial/Pause** to try again. Anytime you want to make a second call to the last number dialed, press **Redial/Pause** to save time.

Tone/Pulse (For Canada Only)

If you have pulse dialing service, but need to send tone signals (for example, telephone banking), follow the directions below. If you have touch tone service, you do not need this feature to send tone signals.

- 1 Lift the handset.
- 2 Press **#**. Digits dialed after **#** will send tone signals.
- 3 When you hang up, the machine returns to pulse dialing service.

Custom Features

Your fax machine supports the Distinctive Ring and Caller ID telephone services offered by some telephone companies.



If you have Voice Mail, Call Waiting, Call Waiting/Caller ID, RingMaster, an answering service, or on alarm system custom feature on your telephone line, it may create a problem in the operation of your machine. (See *I have difficulty with custom features on a single line*, Page 19-8.)

If you have Voice Mail on you phone line, please read the following carefully.

Distinctive Ring

The term “Distinctive Ring” is used by Brother to identify a phone company service that is given *many names, depending on the Telephone Company you are using*. For example, this service may be called SmartRing, RingMaster, Teen-Ring, Indent-a-Call or Indent-a-Ring.

What Does Your Telephone Company’s “Distinctive Ring” Do?

Your telephone company’s Distinctive Ring service allows more than one number to be on the same phone line. **If you need more than one phone number, it is an inexpensive alternative to paying for an additional line.** Each phone number has its own distinctive ring pattern, so you will know which phone number is ringing. This is one way you can have a separate phone number for your fax machine.



Please consult your telephone company for availability and rates.

What Does Brother’s “Distinctive Ring” Do?

The Brother machine has a Distinctive Ring feature that allows you to use your machine to take full advantage of the telephone company’s Distinctive Ring service. You can dedicate the new phone number on your line to receiving only faxes.



You must purchase your telephone company’s Distinctive Ring service *before* you program the Brother machine to work with it.

Do You Have Voice Mail?

If you have Voice Mail on the phone line you on which will install your new machine on, *there is a strong possibility that Voice Mail and the fax machine will conflict with each other while receiving incoming calls.* **However, this Distinctive Ring feature allows the use of more than one number on your line, so both Voice Mail and the fax machine can coexist peacefully.** If each one has a separate phone number, neither will interfere with the other's work.





If you decide to get the Distinctive Ring Service from the telephone company, you will need to follow the directions below to "register" the new Distinctive Ring pattern they provided, so your fax machine can recognize its incoming calls.



You can change or cancel the Distinctive Ring pattern at any time. You can switch it off temporarily and later turn it back on. When you get a new fax number, make sure you reset this setting.

Before You Choose the Ring Pattern to Register

You can register only one Distinctive Ring pattern with the machine. Some ring patterns cannot be registered. Please refer to some popular ring pattern examples that will be provided from the phone company in the USA and Canada that are shown in the Brother compatibility table below.

Ring Pattern	Rings	
1	long - long	
2	short - long - short	
3	short - short - long	
4	very long (normal pattern)	







If the ring pattern the phone company provided cannot be registered by the fax, **please check for other available ring pattern choices from the phone company.**

- The fax machine will answer only calls to its registered number.
- The first two rings are silent on the fax machine. This is because the fax must «listen» to the ring pattern (compare it to the pattern that was "registered"). (Other telephones on the line will ring.)
- If you program the fax machine correctly, it will recognize the registered ring pattern of the "fax number" within 2 ring patterns and then automatically answer with a fax tone. When the "voice number" is called, the fax machine will not interrupt the call.

Very Important

If you have Voice Mail, or a TAD (Telephone Answering Device) and want to keep one of your phone numbers dedicated only to fax calls, you must leave the machine in **MANUAL** mode at all times while using the Distinctive Ring Feature. Here's why: Manual mode will never pick up a call by itself, since it is «Neutral». When the machine is in this «neutral» mode, the Distinctive Ring Feature can be activated. The distinctive ring feature is actually an answering mode. So, do not activate FAX mode or FAX/TEL mode while using distinctive ring; otherwise, the fax machine will answer calls for *all* the numbers.

Registering the Distinctive Ring Pattern

- 1 Set the machine to MANUAL mode.
- 2 Press **Menu, 2, 0, 1**.
- 3 Press  or  to select **DISTINCTIVE:SET** and then press **Set**.
- 4 Press  or  to select the prestored ring pattern you want to assign, and then press **Set**. (You will hear each pattern as you scroll through the four patterns.) Be sure to choose the pattern assigned by the Telephone Company.
- 5 Press **Stop/Exit**.

Caller ID

The Caller ID feature of this machine lets you use the Caller ID subscriber service offered by many local phone companies. This service provides the name or telephone number of your caller on the LCD as the line rings.

After a few rings, the LCD shows the telephone number of your caller (or name, if available). Once you pick up the handset, the Caller ID information disappears from the screen, but the call information remains stored in the Caller ID memory.

- You will see the first 16 characters of the number or name.
- **OUT OF AREA** display means call originates outside your Caller ID service area.
- **PRIVATE CALL** display means the caller has intentionally blocked transmission of information.
- **CALL PICKUP** display remains on the screen when no Caller ID information was transmitted.



If both the name and number are received, the LCD shows only the name. You can print a list of Caller ID information received by your machine.



Caller ID service varies with different carriers. Call your local phone company to determine the kind of service available in your area.

Viewing Caller ID List

Caller ID memory stores information for up to thirty calls; when the thirty-first call comes in, information about the first call is erased. You can scroll through Caller ID information to review those calls made to your machine.

1 Press **Menu, 2, 0, 2.**

2. CALLER ID

2 Press  or  to select **DISPLAY #** and then press **Set.**

If the name was not received, it will not be displayed.

3 Press  or  to scroll through the Caller ID memory to select the Caller ID you want to view and then press **Set.**

The next LCD shows the caller's telephone number and the date and time of the call.

4 Press  or  to return to the Caller ID listing—**OR**—Press **Stop/Exit.**

Clearing a Caller ID Stored in Memory

For effective use of the memory, we recommend that you clear the Caller IDs stored in memory by pressing **Clear** when the LCD shows each caller ID number or name.

Printing Caller ID List

1 Press **Menu, 2, 0, 2.**

2 Press  or  to select **PRINT REPORT** and then press **Set.**

3 Press **Fax Start** to exit.

9

Remote Fax Options

Fax Forwarding/Paging



*You cannot use Paging and Fax Forwarding at the same time.
You cannot use Paging and Fax Forwarding when "Fax Storage" is set to **OFF**.*

Programming a Fax Forwarding Number

When Fax Forwarding is set to **ON**, your machine stores the received fax in memory, then dials the fax number you've programmed, and forwards the fax message.

- 1 Press **Menu**, **2**, **5**, **1**.
- 2 Press or until the LCD shows **FAX FORWARD** and then press **Set**.
- 3 The screen prompts you to enter the number of the fax machine where faxes will be forwarded. Enter the forwarding number (up to 20 digits) and then press **Set**.
- 4 Press **Stop/Exit**.

1.FAX FWD/PAGING

FAX FORWARD?
SELECT & SET

FWD#:
ENTER & SET KEY



Programming Your Pager Number

When Paging is selected, your machine dials the pager number you've programmed, and then dials your Personal Identification Number (PIN); this activates your pager so you know you have a fax message in the memory.

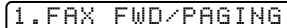
- 1** Press **Menu**, **2**, **5**, **1**.



1.FAX FWD/PAGING

- 2** Press  or  until the LCD shows **PAGING** and then press **Set**.

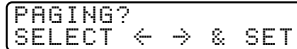

PAGING?
SELECT < > & SET

- 3** Enter your pager phone number (up to 20 digits) followed by **# #**, and then press **Set**. Do not include the area code if it is the same as that of your machine.

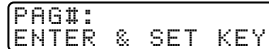

PAG#:
ENTER & SET KEY

For example, 1 8 0 0 5 5 1 2 3 4 # #.

- 4** If your pager requires a PIN, enter the PIN, press **#**, press **Redial/Pause**, enter your fax number followed by **# #**, and then press **Set**.

For example, 1 2 3 4 5 # #, Redial/Pause 1 8 0 0 5 2 1 8 4 6 # #.

—OR—If you do not need a PIN, press **Redial/Pause**, enter your fax number followed by **# #**, and then press **Set**.

For example, Redial/Pause 1 8 0 0 5 2 1 2 8 4 6 # #.

- 5** Press **Stop/Exit**.



You cannot change a Paging number or PIN remotely.





Press **Redial/Pause** for each 3.5 second delay, as needed.



Setting Fax Storage

If you set Fax Storage to **ON**, you will be able to retrieve fax messages from another location using Fax Forwarding, Paging or Remote Retrieval functions. The LCD will indicate when you have a fax stored in memory. (See *Remote Retrieval*, Page 9-4.)

- 1** Press **Menu, 2, 5, 2**. The screen prompts you to choose a fax setting.

2.FAX STORAGE

- 2** Press  or  to select **ON** (or **OFF**), and then press **Set**.

FAX STORAGE:OFF?
SELECT   & SET

- 3** Press **Stop/Exit**.



If there are faxes in memory when you turn Fax Storage to **OFF**, the LCD prompts you to erase any faxes in memory.

- 4** If you press **1**, all fax data is erased and Fax Storage is turned off. If you press **2**, data is not erased and Fax Storage remains on.

ERASE ALL FAX?
1.YES 2.NO



Fax Forwarding and Remote Retrieval will work while Memory Security is **ON** if you turn Fax Storage **ON** first.



Backup Print

If you have set **FAX STORAGE** to **ON**, your faxes will be received into memory, so you can retrieve them remotely. With **BACKUP PRINT** set to **ON**, your machine *automatically* prints faxes as they are received into memory. You can turn Backup Print **OFF** to save paper or prevent confidential documents from printing in your absence.

- 1** Press **Menu, 2, 5, 5**. The screen prompts you to choose a fax setting.

5.BACKUP PRINT

- 2** Press  or  to select **ON** (or **OFF**), and then press **Set**.

BACKUP PRINT:ON?
SELECT   & SET

- 3** Press **Stop/Exit**.

Changing Remote Retrieval Access Code

Enter your Remote Retrieval Access Code when the machine picks up your call, so you can access features remotely. The access code is preset to 1 5 9 ✳, but you can change this. The ✳ cannot be changed.

- 1** Press **Menu, 2, 5, 3**.

3.REMOTE ACCESS

- 2** Enter a three-digit number from 000 to 999, and then press **Set**.

(Do not use the same digits that appear in your Fax Receive Code or Telephone Answer Code.)

- 3** Press **Stop/Exit**.

Remote Retrieval

You can call your machine from any fax machine using touch tone and use a Remote Retrieval Access Code and other button presses to retrieve fax messages. *Cut out the Remote Retrieval Access Card on the last page and keep it in your wallet as an aid.*

Using Remote Retrieval Access Code

- 1** Dial your fax number from a fax machine using touch tone.
(See *Changing Remote Retrieval Access Code*, Page 9-3.)
 - 2** When your machine answers and beeps, immediately enter your Remote Retrieval Access Code (1 5 9 ✖).
 - 3** Your machine signals the kinds of messages received:
 - 1 long beep — Fax message(s)**
 - No long beeps — No messages**
 - 4** Your machine then prompts you with two short beeps to enter a command. If you wait longer than 30 seconds to enter a command, your machine hangs up. If you enter an invalid command, your machine beeps three times.
 - 5** Press **9 0** to reset your machine when you're finished.
 - 6** Hang up.
-  If your machine is set to MANUAL mode, you can access your machine by waiting about 2 minutes, and then entering the Remote Retrieval Access Code within 30 seconds.

Remote Commands

Follow the commands below to access features remotely. When you call your machine and enter your Remote Retrieval Access Code (1 5 9 ✳), the system will signal you with two short beeps to enter a remote command.

Remote Commands	Operation Details
95 Changing Fax Forwarding /Paging setting	
1 OFF	If you hear one long beep, the change is accepted. If you hear three short beeps, you cannot change it because the conditions have not been met. (Example: registering paging number). You can register your fax forwarding number by using 4. FAX FWD NO (See Page 9-6). Once you have registered the number, your machine will change automatically to FAX FWD:ON mode.
2 Fax Forwarding	
3 Paging	
4 FAX FWD No.	
6 Fax Storage ON	
7 Fax Storage OFF	You can set FAX STORAGE to ON or OFF.
96 Retrieve a fax	
2 Retrieve all faxes	Enter the number of a remote fax machine to receive stored fax message(s). (See Page 9-6.)
3 Erase fax from the memory	If you hear one long beep, you can erase fax message(s) from the memory.
97 Check the Receiving Status	
1 Fax	You can check whether your machine has received any fax message(s). If yes, you will hear one long beep. If no, you will hear three short beeps.
98 Change Receive Mode	
1 TAD	If you hear one long beep, you can change the Answer Mode.
2 FAX/TEL	If you hear three short beeps, you cannot change it.
3 FAX	
90 Exit	After a long beep, you can exit remote retrieval.

Retrieving Fax Messages

- 1** Dial your fax number.
 - 2** When your machine answers, immediately enter your Remote Retrieval Access Code (**1 5 9 ***).
 - 3** As soon as you hear two short beeps, use the dial pad to press **9 6 2**.
 - 4** Using the dial pad, enter the number (up to 20 digits) of the remote fax machine where you want your fax messages forwarded, followed by **# #**.
-  You cannot use ***** and **#** as dial numbers. However, if you want to store a pause, and then press **#**.
- 5** After you hear your machine beep, hang up and wait.
Your machine calls the remote fax machine. The remote fax machine prints your fax messages.

Changing Fax Forwarding Number

You can change the default setting of your fax forwarding number from a remote fax machine.

- 1** Dial your fax number.
 - 2** When your machine answers, immediately enter your Remote Retrieval Access Code (**1 5 9 ***).
 - 3** When you hear two short beeps, enter **9 5 4**.
 - 4** Enter the new telephone number of the remote fax machine (up to 20 digits) where you want your fax messages forwarded, followed by **# #**.
-  You cannot use ***** and **#** as dial numbers. However, if you want to store a pause, press **#**.
- 5** After you hear your machine beep, hang up.

10 Printing Reports

Machine Settings and Activity

Two reports require initial setup in the Menu: Transmission Verification Report and Fax Activity Report Interval. For initial setup:

Press **Menu, 2, 4, 1.**

1. TRANSMISSION

—OR—

Press **Menu, 2, 4, 2.**

2. ACT. INTERVAL

Customizing the Transmission Verification Report

You can use the Transmission Report as proof that you sent a fax. This report lists the job number time and date of transmission and whether the transmission was successful (OK). If you select **ON** or **ON+IMAGE**, the report will print for every fax you send.



When the feature is **OFF**, the report prints only if a transmission *error* prevented delivery (NG).

If you typically send multiple faxes to the same destinations, you may need more than the job numbers to identify the faxes you must send again. Selecting **OFF+IMAGE** will print a portion of the fax's first page on the report to help you remember.

1 Press **Menu, 2, 4, 1.**

1. TRANSMISSION

2 Press or to select **OFF**, **OFF+IMAGE**, **ON** or **ON+IMAGE**, and then press **Set**.

3 Press **Stop/Exit**.

Setting the Fax Activity Report Interval

You can set the machine to print activity reports at specific intervals (EVERY 50 FAXES, 6, 12, 24 hours, 2 or 7 days). If you set the interval to **OFF**, you can print the report by following the Steps in the next page.

1 Press **Menu, 2, 4, 2.**

2. ACT. INTERVAL

2 Press or to choose an interval, and then press **Set**.

INTERVAL: OFF
SELECT & SET

(If you choose 7 days, the LCD prompts you to choose a day at which to begin the 7-day countdown.)

- 3 Enter the time to begin printing, in 24-hour format, and then press **Set**. (For example: enter 19:45 for 7:45 PM.)
- 4 Press **Stop/Exit**.

Using the Reports Key



- 1 Press **Reports**.
- 2 Press  or  to select the report you want, and then press **Set**.

—OR—

Enter the number of the report you want to print. For example, press **1** to print the Help List.

Five reports are available:

- 1.HELP LIST
- 2.AUTO DIAL
- 3.FAX ACTIVITY
- 4.TRANSMISSION
- 5.USER SETTINGS

Prints the Help List so you can see at-a-glance how to quickly program every menu selection.

Lists names and numbers stored in One Touch and Speed Dial memory, in numerical order.

Lists information about the incoming and outgoing faxes. TX means Transmit; RX means Receive.

Prints a Transmission Verification Report for your last transmission.

Lists settings for **GENERAL SETUP, SETUP RECEIVE, SETUP SEND, SETUP REPORT, REMOTE FAX OPT** and **MISCELLANEOUS**.



Don't forget to set up the Fax Activity Report and Transmission Verification Report as explained on page 10-1.

11 Making Copies

Using Your Machine as a Copier

You can use your machine as a copy machine, making up to 99 copies at a time. The machine can stack the copies or collate (sort) them.

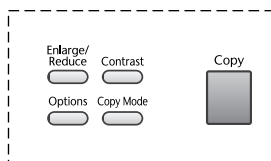

The scannable area of your Brother machine begins at approximately one-sixth inch (4mm) from the edge of the paper.

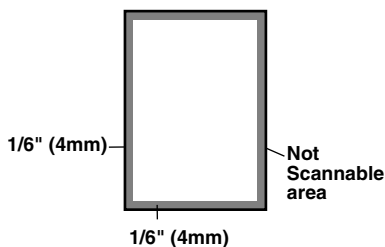

 Incoming faxes cannot be received on paper or into memory while the machine is copying.

Making a Single Copy

- 1 Place the original face down in the ADF.
- 2 Press **Copy**.
Do **NOT** pull on the paper while copying is in progress.

 **Note** To Stop the copy process, press **Stop/Exit**.
To release the original document, press **Stop/Exit** again.

Making Multiple Copies

- 1 Place the original face down in the ADF.
- 2 Use the dial pad to enter the number of copies you want (up to 99).
- 3 Press **Copy**.

 To sort the copies, use the **Options** key.
(See *Using the Options Key*, page 11-4.)

Out of Memory Message

If the memory becomes full while you are scanning a document to be copied the LCD shows:

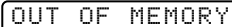

OUT OF MEMORY

If the **OUT OF MEMORY** message appears while you are scanning the first page of your original, press **Stop/Exit** to cancel. You will need to clear some faxes from memory before you can continue.



To gain extra memory, you can turn off Fax Storage (see page 9-3).
—OR—Print fax messages in memory (see page 5-6).

Temporary Copy Settings

You can improve your copies by using the Copy keys: **Enlarge/Reduce**, **Contrast**, **Options** and **Copy Mode**. These settings are temporary, and the machine returns to its default settings when you finish copying.

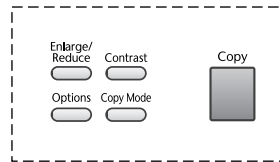

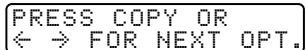

Copying Using Multiple Settings

You can try different combinations of settings for the best results. After you finish your settings using the **Enlarge/Reduce** or **Options** keys, the LCD shows:



PRESS COPY OR
← → FOR NEXT OPT.

- Press  or  if you want to select additional settings.

—OR—

Press **Copy** if you are finished choosing settings.

Using the Enlarge/Reduce Key

AUTO sets the machine to calculate the ratio that fits the size of your paper.

ZOOM allows you to enter a ratio from 50% to 200% in 1% increments.

Press Enlarge/Reduce and ⬅ or ➡	50%
	78% LGL>LTR
	94% A4>LTR
	AUTO
	100%
	104% EXE>LTR
	150%
	200%
	ZOOM

- 1 Place the original face up in the ADF, or face down on the scanner glass.
- 2 Use the dial pad to enter the number of copies you want (up to 99).
- 3 Press **Enlarge/Reduce**. (Enlargement or reduction ratios appear.)
- 4 Press ⬅ or ➡ to select **50%**, **78%**, **94%**, **AUTO**, **100%**, **104%**, **150%**, **200%** or **ZOOM**, and then press **Set**. (Enlargement *or* reduction ratios appear.)

—OR—

For more choices select **ZOOM**, and the press **Set**. Use the dial pad to enter any percentage between **50%** and **200%**.

- 5 Press **Copy**—OR—Press ⬅ or ➡ for additional settings.



Special Copy Options (2 in 1, 4 in 1 or OFF) are not available with **Enlarge/Reduce**.



When selecting an enlargement or reduction ratio, you will need to know the size of the paper you registered in Menu 1-1.

Selecting a Fixed Ratio:

Original is the size of...	Paper size is...	Recommended ratio is...
LETTER	LEGAL	100%
A4	LETTER	94%
LEGAL	LETTER	78%

Copy Contrast

You can adjust copy contrast to make copies darker or lighter.

- 1 Place the original face down in the ADF.
- 2 Use the dial pad to enter the number of copies you want (up to 99).
- 3 Press **Contrast**.
- 4 Press  to make a copy lighter, or  to make a copy darker, and then press **Set**.
- 5 Press **Copy**.





Using the Options Key

Use the **Options** key to temporarily change the copy mode (resolution), contrast and special copy options *for the next fax only*. See the explanations below the table.

Press Options	Menu Selections	Options	Factory Setting
 Options	OPT:# OF COPIES	NO. OF COPIES:XX	01
	OPT:STACK/SORT	STACK/SORT	STACK
	OPT:SPECIAL	2IN1/4IN1/OFF	OFF
	OPT:PAPER TYPE	THIN/PLAIN/ THICK/THICKER/ TRANSPARENCY	PLAIN

Number of Copies

If you are using the **Options** key for sorting or choosing a special layout, you can also enter the number of copies here first for convenience.

- 1 Place the original face down in the ADF.
- 2 Press **Options** and  or  to select **OPT: # OF COPIES**, and then press **Set**.
- 3 Use the dial pad to enter the number of copies (up to 99).
- 4 Press **Copy**. —OR— Press  or  for additional settings.

OPT:#OF COPIES01

Sorting Multiple Copies

- 1 Place the original face down in the ADF.
- 2 Use the dial pad to enter the number of copies you want (up to 99).
- 3 Press **Options** and \leftarrow or \rightarrow to select **OPT:STACK/SORT**, and then press **Set**.
- 4 Press \leftarrow or \rightarrow to select **SORT**, and then press **Set**.
- 5 Press **Copy**. —OR— Press \leftarrow or \rightarrow for additional settings.

Special Layout Options

You can save paper by copying either two or four pages onto one page.

- 1 Place the original face down in the ADF.
- 2 Use the dial pad to enter the number of copies you want (up to 99).
- 3 Press **Options** and \leftarrow or \rightarrow to select **OPT: SPECIAL**, and then press **Set**.
- 4 Press \leftarrow or \rightarrow to select **2 IN 1 COPY** or **4 IN 1 COPY** and then press **Set**.
- 5 Press **Copy**.

2IN1
SELECT \leftarrow \rightarrow & SET

4IN1
SELECT \leftarrow \rightarrow & SET

2in1

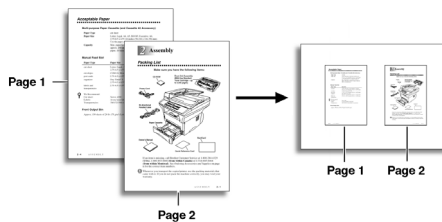

4in1

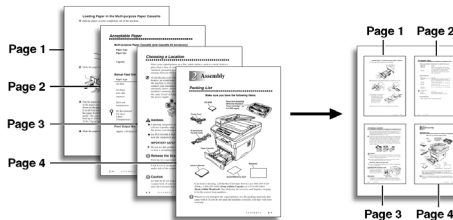







Special Copy Options (2in1 or 4in1 Copy) are not available with **Enlarge/Reduce** or **SORT**.

Paper Type

You can use the following types of paper for copying. For the best print quality, select the type of media that you are using.

- THIN** (16lb - 18.4lb) - For thin paper or transparency
- PLAIN** (18.7lb - 25.3lb) - For ordinary plain paper
- THICK** (25.6lb - 32lb) - For heavy weight paper or rough paper
- THICKER** (32.3lb - 42.1lb) - For heavier weight paper, rough paper or bond paper.
- TRANSPARENCY** - For transparency (OHP)

- 1** Press **Options** and  or  to select **OPT:PAPER TYPE**, and then press **Set**.
- 2** Press  or  to select your type of paper, and then press **Set**.
- 3** Press **Copy**—**OR**—Press  or  for additional settings.

Changing Default Copy Settings

Press **Menu** and **3** to change default settings for Copy mode. These settings will remain until you change them again by pressing **Menu**. Adjust the Contrast and Quality settings.

By pressing a number, you can adjust copy settings as shown in the following chart. Press \leftarrow or \rightarrow to scroll through the options for each setting. Press **Set** to save your selection. Press **Stop/Exit**—OR—Press \rightarrow to select the next setting you want to change.

Press **Menu**, and **3**.

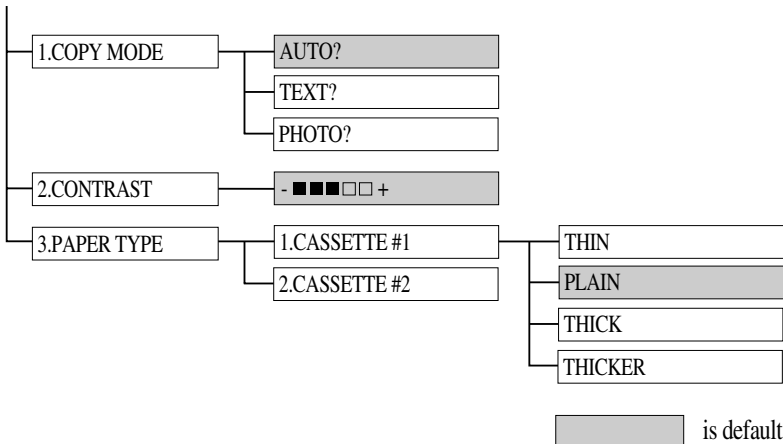

If you have attached Cassette #2, be sure you turn it ON and setup the Paper Size and Cassette Usage. (See *Setting Paper Size* and *Turning on Cassette #2 (Option for FAX-4750e).*)

Copy Mode (Type of Original)

You can select the Copy resolution for your type of original. The default setting is **AUTO**, which is used for originals that contain both text and photographs. **TEXT** is used for originals containing only text. **PHOTO** is used for copying photographs.

- 1 Press **Menu**, **3**, **1**.
- 2 Press \leftarrow or \rightarrow to choose the type of original (**AUTO**, **TEXT** or **PHOTO**), and then press **Set**.
- 3 Press **Stop/Exit**.

1. COPY MODE

Copy Contrast

You can adjust copy contrast to make copies darker or lighter.

1 Press **Menu, 3, 2.**

2. CONTRAST

2 Press  to make a copy lighter—**OR**—

Press  to make a copy darker, and then press **Set.**

3 Press **Stop/Exit.**

Paper Type

You can use the following types of paper for copying. For the best print quality, select the type of media that you are most often.

THIN (16lb - 18.4lb) - For thin paper



PLAIN (18.7lb - 25.3lb) - For ordinary plain paper

THICK (25.6lb - 32lb) - For heavy weight paper or rough paper

THICKER (32.3lb - 42.1lb) - For heavier weight paper, rough paper or bond paper.

1 Press **Menu, 3, 3.**

3. PAPER TYPE

2 Press  or  to select your type of paper, and then press **Set.**

3 Press **Stop/Exit.**

After you connect the optional Cassette #2, you can select the paper size for each cassette. (See page 4-1.)

12 Printer Driver Settings (For Windows® Only)

Using the Brother FAX-4750e and FAX-5750e Printer Driver

A Printer Driver is software that translates data from the format used by a computer into the format required by a particular printer. A driver uses a printer command language or page description language.

The printer drivers are on the supplied CD-ROM. The latest printer driver can also be downloaded from the Brother Solutions Center at <http://solutions.brother.com>.

Features in the Printer Driver



The screens shown in this section are from Windows® 98. The screens on your PC may vary depending on your Windows® Operating System.

For more detailed information, please see the on-line Help in the printer driver.

You can also change settings by clicking the illustration on the left side of the tab screen.

Basic Tab

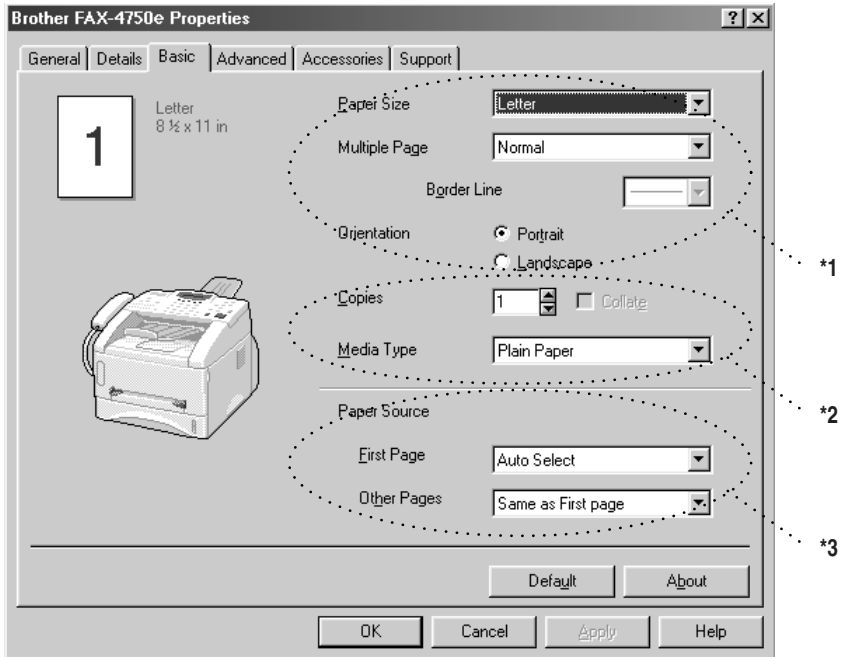

- *1 Select the Paper size, Multiple Page and Orientation.
- *2 Select number of Copies and Media Type.
- *3 Select Paper Source, First Page and Other Pages.

Paper Size

From the drop-down box select the Paper Size you are using.

Multiple Page

The Multiple Page selection can reduce the image size of a page allowing multiple pages to be printed on one sheet of paper or enlarging the image size for printing on page on multiple sheets of paper.

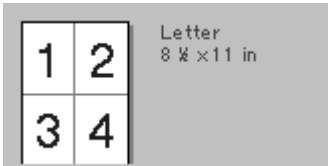

Ex. 4 in 1



Ex. 1 in 2 x 2 pages

Border Line

When printing multiple pages on one sheet with the Multiple Page feature you can select to have a solid border, dash border or no border around each page on the sheet.

Orientation

Orientation selects the position of how your document will be printed (Portrait or Landscape).

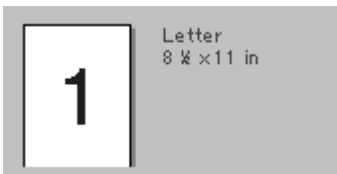

portrait

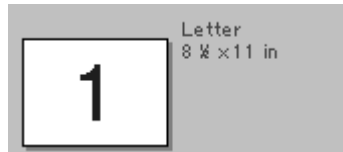

Landscape

Copies

The copies selection sets the number of copies that will be printed.

Collate

The collate selection is active if more than one copy is selected. With the collate check box selected, one complete copy of your document will be printed and then repeated for the number of copies you selected. If the collate check box is not selected then each page will be printed for all the copies selected before the next page in the document is printed.

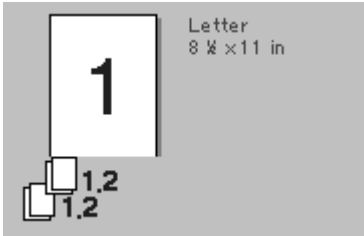

Collate box checked

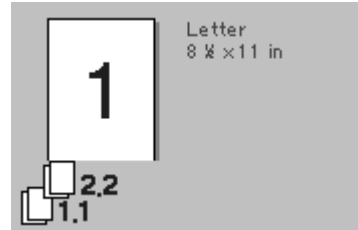

Collate box not checked

Media Type

You can use the following types of media in your printer. For the best print quality, select the type of media that you wish to use.

Plain Paper

Thin Paper

Thick Paper

Thicker Paper

Bond Paper

Transparencies

When using ordinary plain paper, select **Plain Paper**. When using heavier weight paper, envelopes or rough paper select **Thick Paper** or **Thicker Paper**. For bond paper, select **Bond Paper** and for OHP transparencies, select **Transparencies**.

Advanced Tab

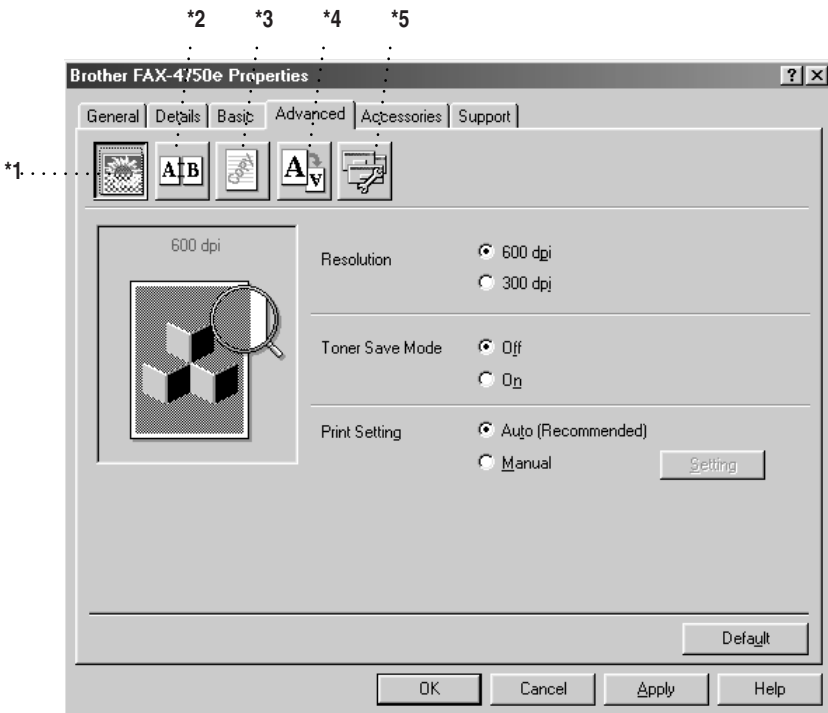

Change the tab settings by selecting one of the following icons:

- *1 Print Quality
- *2 Duplex Printing
- *3 Watermark
- *4 Page Setting
- *5 Device Option

Print Quality

Resolution

You can change the resolution as follows:

- 300 dpi
- 600 dpi

Toner Save

You can save running costs by turning on the Toner Save Mode, which reduces the print density.

Print Setting (For Windows® 95/98/98SE/Me Only)

Print Setting is used for optimizing your print quality for the type of document being printed (Photos, Graphics or Scanned Images). When you choose **Auto (Recommended)**, the printer automatically prints with the most suitable print settings.

With the Print Setting set to Manual, you can change the Brightness, Contrast and Graphics Quality options manually.

Duplex Printing

Choosing the Duplex Printing icon displays the Manual Duplex features available.

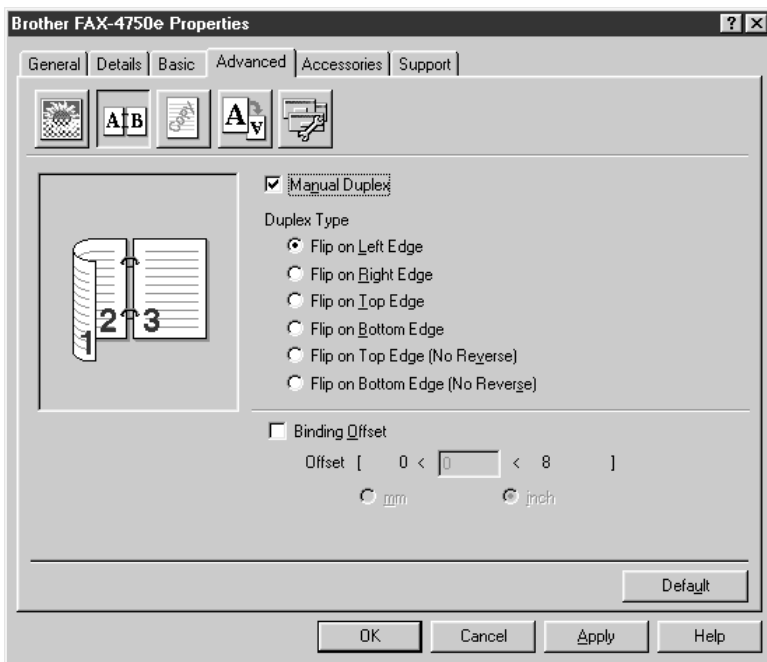

Manual Duplex

Check the Manual Duplex box and there are six types of duplex directions available for each orientation. In this mode, the MFC prints all the even numbered pages first. Then the printer driver stops and shows the instructions required to re-install the paper. When you click OK the odd numbered pages are printed.

Binding Offset

Check the Binding Offset option, you can specify the offset value of the binding side in inches or millimeters (0 - 8 inches) [0 - 203.2 mm].

Watermark

You can place a logo or text into your document as a Watermark by using a bitmap file as your source file or select one of the preset Watermarks.



Print Watermark

The Print Watermark feature offers printing choices of:

On all pages

On first page only

From second page

Custom

In Background

With the In Background feature checked the Watermark will print behind your document on the page. If this feature is not checked then the Watermark will print on top of your document.

You can change the size and the position of the Watermark on the page by selecting the Watermark and clicking the Edit button. If you want to add a new Watermark, click the New button and select Text or Bitmap from the Watermark Style.

Watermark Text

Enter your Watermark text into the Text Box and select the Font, Size, Darkness and Style.

Watermark Bitmap

Enter the file name and location of your bitmap image in the File box or Browse for the file location. You can also set the scaling size of the image.

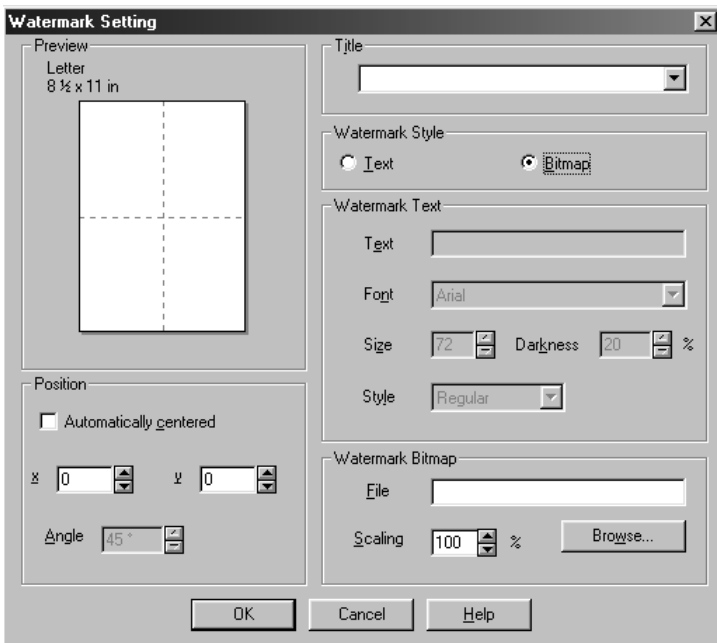

Position

The position settings offer controls on where the Watermark can be positioned on the page.

Page Setting

You can change the print size of your document with the Scaling feature.

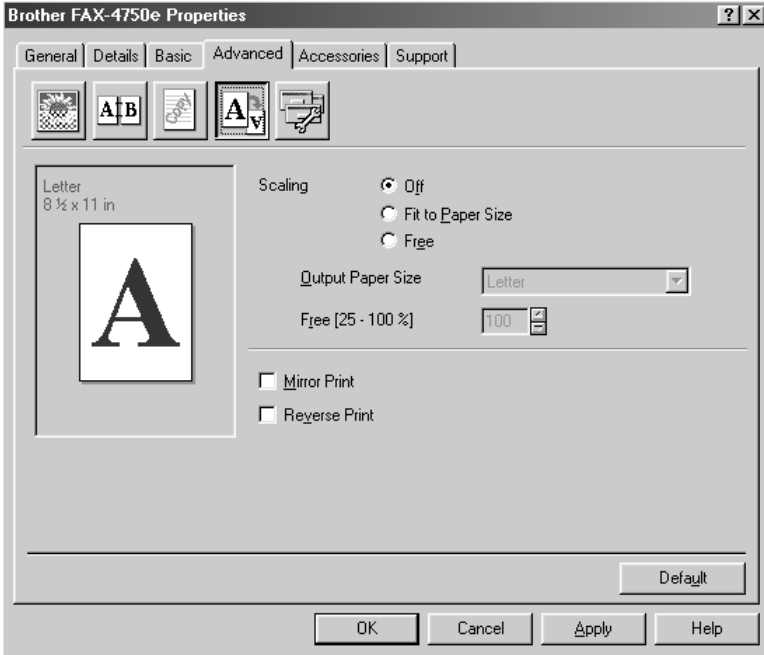

- 1 Check Off if you want to print the document as it appears on your screen.
- 2 Check Fit to Paper Size, if your document has an unusual size, or if you have only the standard size paper.
- 3 Check the Free box if you want to reduce or enlarge the output.

You can also use the Mirror or Reverse Print feature for your page setting.

Device Options

Set one of the following Printer Functions:

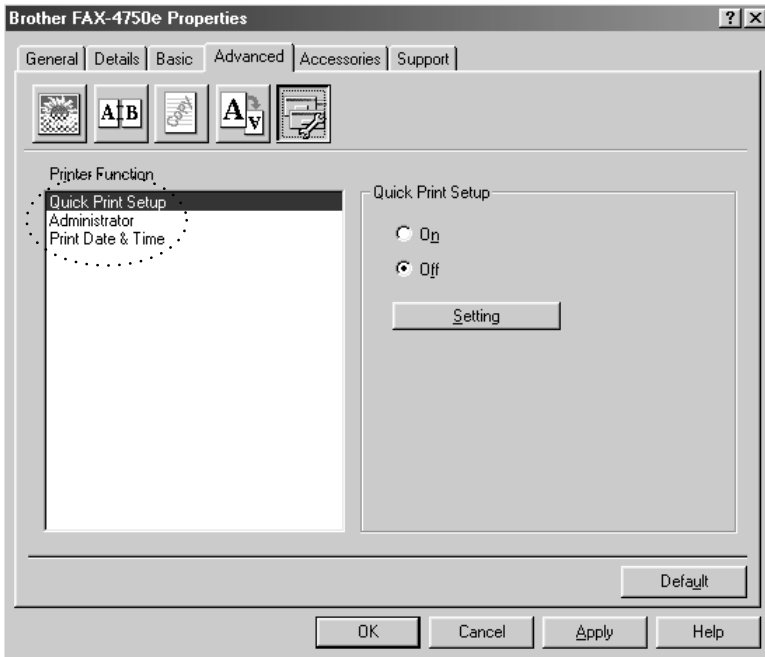

Quick Print Setup

Administrator (For Windows® 95/98/98SE/Me Only)

Print Date & Time

Quick Print Setup

The Quick Print Setup feature allows you to quickly select driver settings. To view settings, simply click your mouse button on the task tray icon. This feature can be set to ON or OFF from the Device Options section.

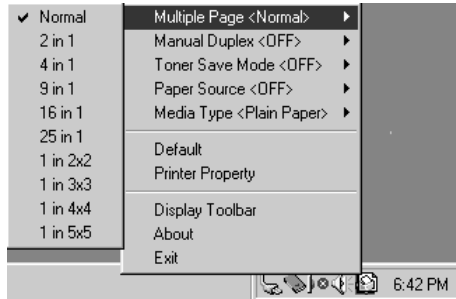

Administrator (For Windows® 95/98/98SE/Me Only)

The administrator selection permits the Copy, Scaling and Watermark features to be locked and password protected.

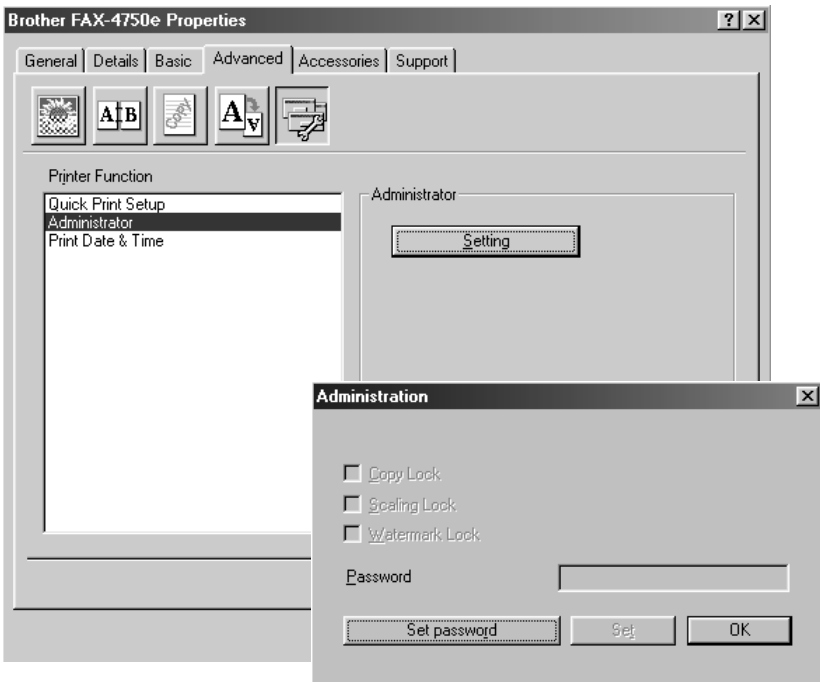

Record your password and keep it in a safe place for future reference. If you forget your password these settings can not be accessed.

Print Date & Time

When enabled the Print Date and Time feature will automatically print the date and time from your computers system clock on your document.

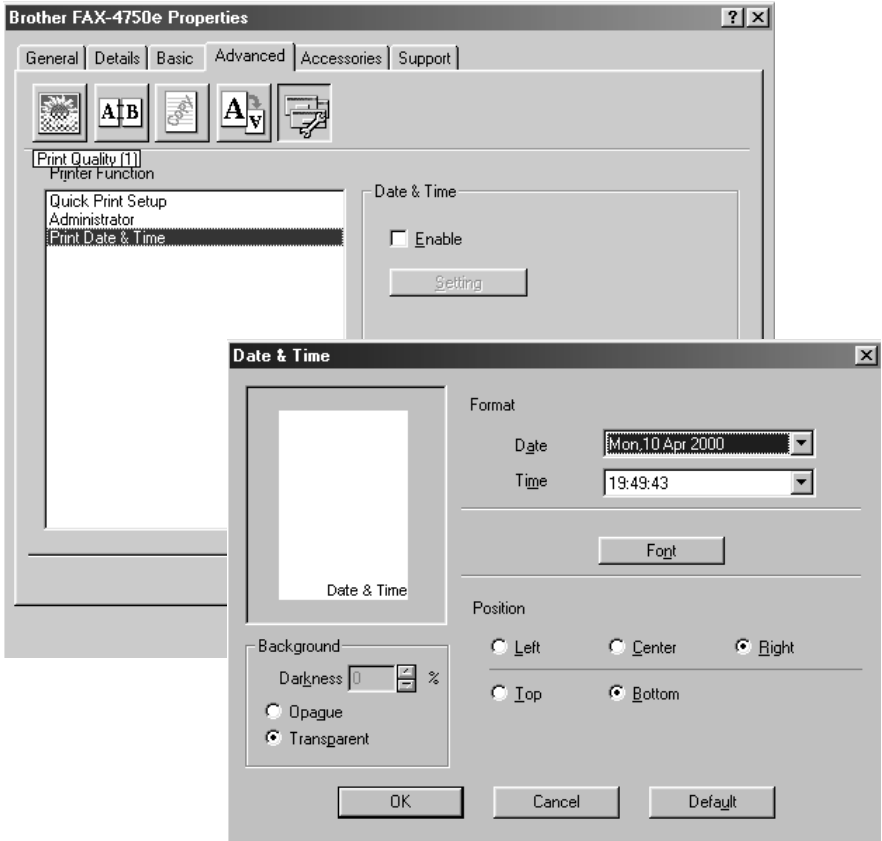

Click the Setting button to change the Date and Time Format, Position and Font. To include a background with the Date and Time select Opaque. When Opaque is selected you can set the Darkness of the Date and Time background by changing the percentage.



The Date and Time indicated in the selection box represents the format the will be printed. The actual Date and Time printed on your document is automatically retrieved from the settings of your computer.

Accessories Tab

The Accessories Tab includes the settings for configuring the printer driver for what size paper is being used for each paper source. This tab also installs any additional options into the driver settings.

Paper Source Setting

To configure the paper size for each paper source, highlight the source from the **Paper Source Setting** list. Select the **Paper Size** from the pull-down box and click **Update**. (The Paper Source Setting is used when selecting **Auto Select** in the Basic Tab.)

Default Source

The Default Source allows you to choose which paper source will be used when the paper size of the document being sent does not match the Paper Source Settings.

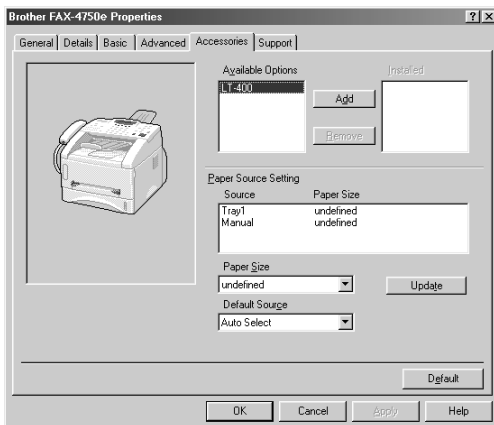

Available Options

In order to access the optional 2nd paper tray the option must be installed in the driver. Highlight the model number from the **Available Options** list and click **Add**. The optional tray will then be listed in the Installed box, Paper Source Setting list and the screen illustration will display the 2nd tray.

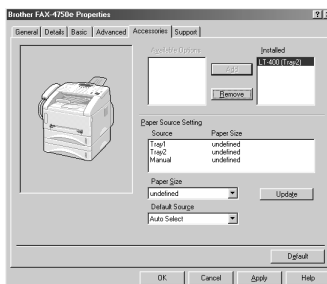

Support

The Support Tab provides driver version information and setting information. In addition there are links to the Brother Solution Center and Driver Update Web sites.

Brother Solutions Center

The Brother Solutions Center is a Web site offering information about your Brother product including FAQ's , User Guides, Driver updates and Tips for using your machine.

Web Update

Web Update checks the brother web site for updated drivers and automatically downloads and updates the driver on your computer.

Check Setting

The Check Setting selection displays a list of your current drivers settings.

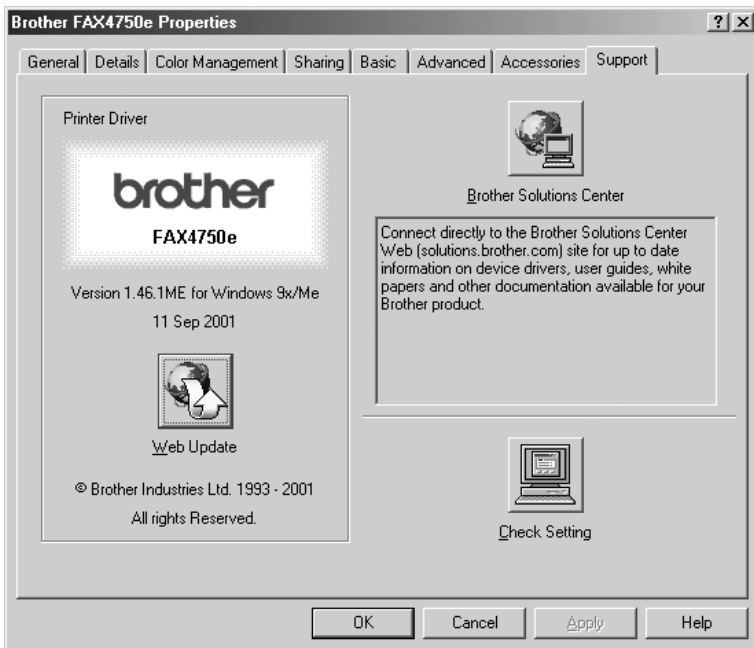

Features in the Printer Driver (For Windows® 2000)

The Windows® 2000 printer driver utilizes Microsoft's uni-driver architecture. The following section describes the driver features and selections available for Windows® 2000.

General Tab

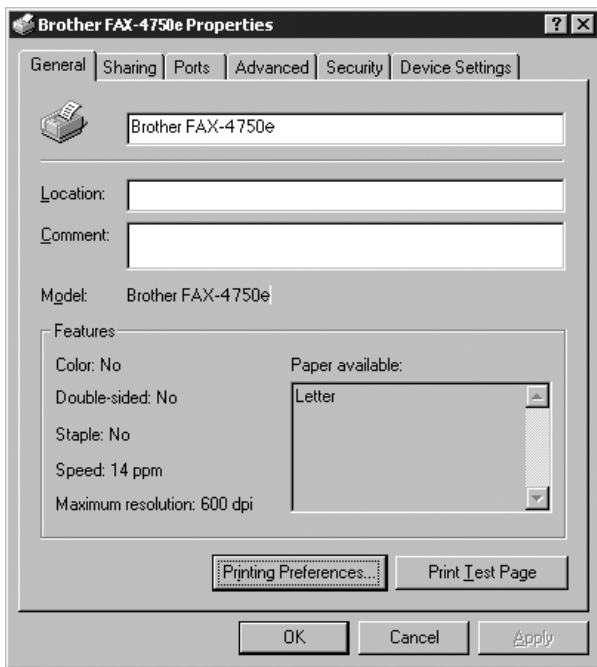

Printing Preferences

In the General tab, click the **Printing Preferences...** button to access the Layout tab.

Layout Tab

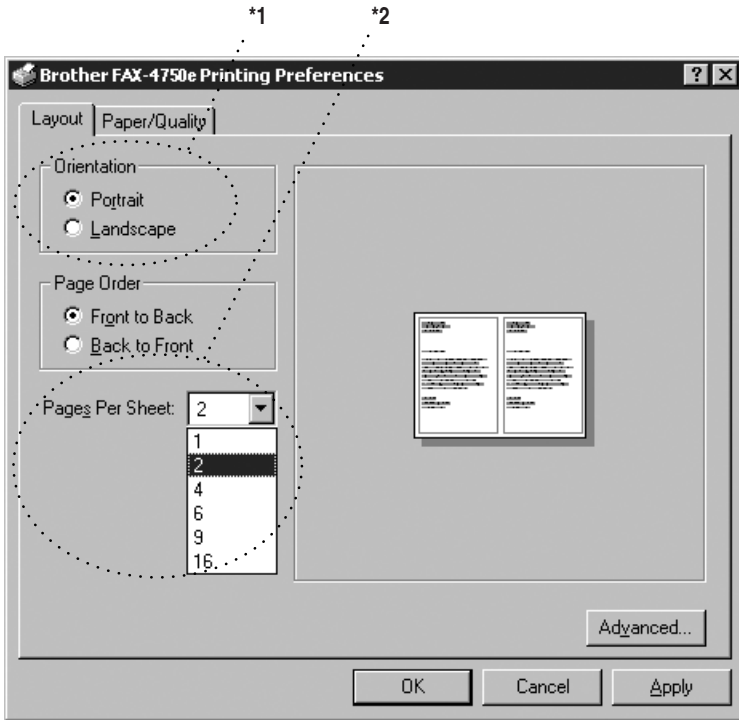

*1 Orientation

Select the Orientation, which is how your document will be positioned on the paper (Portrait or Landscape).



Portrait

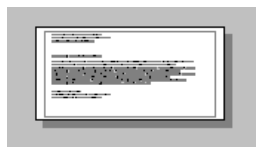

Landscape

*2 Pages Per Sheet

You can select 1, 2, 4, 6, 9 or 16 pages to be printed on one sheet of paper. The image of each page will be reduced as needed to fit on the paper.

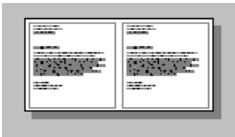

2 in 1

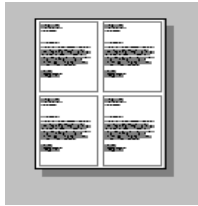

4 in 1

Paper/Quality Tab

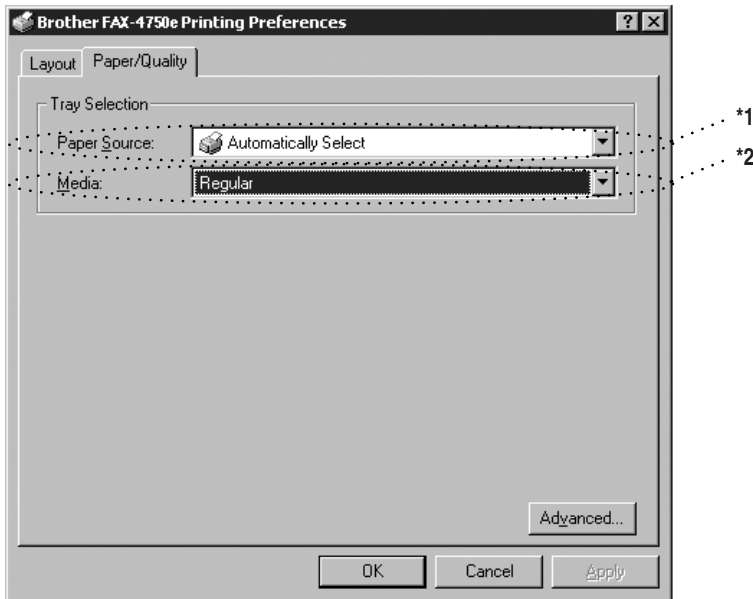

*1 Paper Source

Possible paper sources are: Automatically Select, Auto, Upper Paper Tray, Lower Paper Tray (optional cassette #2) and Manual Paper Feed.

When “Automatically Select” is chosen the machine automatically will choose the cassette with the appropriate size of paper.

Note The paper size for each paper source must be set in the Device Settings tab for the Automatically Select feature to work properly.

The “Auto” option is for machines that can automatically detect the size of paper that is loaded in the paper source; Auto is not active for your machine.

*2 Media

For the best print quality, select the type of media you are using:

Regular

Thick Paper

Thicker Paper

Transparency

When using ordinary plain paper, select Regular. When using heavier weight paper, envelopes, or rough paper, select Thick Paper or Thicker Paper. For OHP transparencies, select Transparency.

Advanced Options

Click the **Advanced...** button in the Paper/Quality tab to access the screen below:

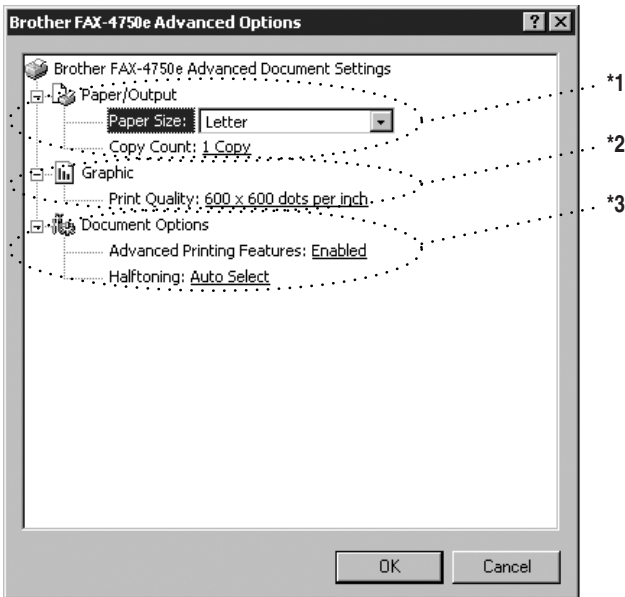

*1 Paper /Output

Paper Size – Select the paper size of the document you are printing. This size should be the same as the paper size that is set in your application software.

Copy Count – Type the number of copies you want.

***2 Graphic**

Print Quality – You can change the resolution as follows:

600 × 600 dots per inch

300 × 300 dots per inch

***3 Document Options**

Advanced Printing Features – You can Enable or Disable Advanced Printing Features from this selection. If you disable it, Page Order, Pages Per Sheet, Copy and Collate will be disabled.

Halftoning – This selection is for changing the dither pattern to achieve the best print results when printing graphics. The choices are as follows:

Auto Select

Super Cell

Dither 6 × 6

Dither 8 × 8

Device Settings Tab

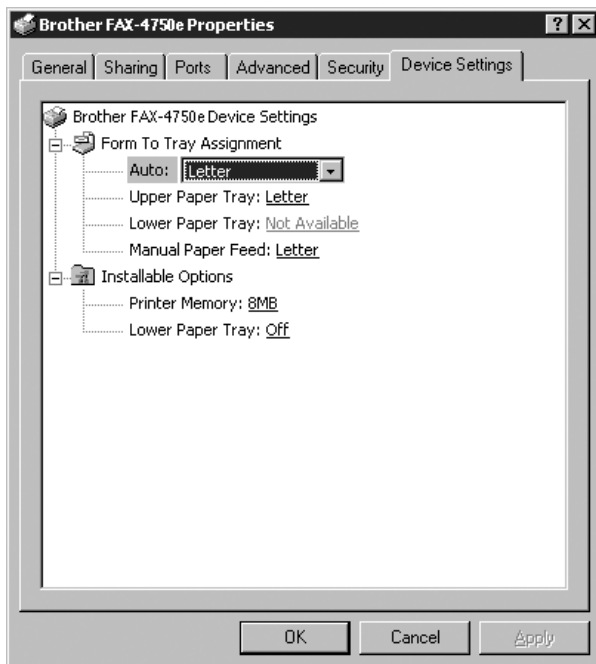

Form To Tray Assignment – This selection assigns the paper size to each paper source. For auto paper selection (Automatically Select) to work properly, the paper size set for each source must match the actual size of paper loaded.

The available options are:

- A4
- A5
- B5 (JIS)
- Executive
- Legal
- Letter

Installable Options

Printer Memory – If you installed optional memory in your machine, you must select the correct size of total memory in the machine for the driver to access the additional memory.

Lower Tray – If an optional lower tray is installed, this selection must be set to ON to enable access to the lower tray.

13 For DOS Users (For FAX-5750e Only)

How to Use the Brother machine with Your DOS Application Software

Before working with your application software that runs on DOS, check that the Brother machine's name appears in the printer selection of your application software. If the machine is not listed, you must install the printer driver that corresponds to HP LaserJet's emulations.

The following table shows combinations of printer drivers and emulation mode. To get the most out of this machine, you should install an HP printer driver in your application software.

Printer driver supported in your application software	Emulation mode to be selected with the remote printer console program
HP LaserJet 5P™	HP LaserJet 5P's emulation mode

- The best or recommended printer driver is indicated in bold.
- Be sure to choose the proper printer driver in your application software.
- Be sure the printing resolution is set to 600 dpi in your DOS application software.

What Does the Remote Printer Console Do?

The Remote Printer Console (RPC) is a utility program that can run in the DOS environment and comprises the following program:

Remote Printer Console Main Program

This program allows you to change various printer settings such as emulation, print quality, fonts and page setup from your computer screen. Since most DOS applications have a Printer Settings menu that overrides the settings made by the RPC, you may not have to use this utility program. This utility program is useful for application software that does not control the printer's settings and features.

Installing the Remote Printer Console

Before you install the program, make sure you have the following hardware and software to install the program:

DOS	Version 3.3 or later
Monitor	EGA/VGA or compatible
Option	Mouse; the mouse driver must be installed. (You can also operate the program with the keyboard.)

Follow these steps to install the remote printer console program:

- 1** Make sure your Brother machine is connected to your computer and is set to Online.
- 2** Start your computer and go to the DOS prompt. If you are in Windows®, exit and return to the DOS prompt.
- 3** Insert the Brother CD-ROM into your CD-ROM drive.
- 4** At the DOS prompt (C:\>) type x: (Substitute the drive letter of your CD-ROM drive for “x”), and then press Enter.

```
C:\>x:
```

- 5** Type CD DOS, and then press Enter.

```
x:\>CD DOS
```

- 6** Type RPCSETUP, and then press Enter.

```
x:\DOS>RPCSETUP
```

- 7** Follow the instructions in the installer.

Using the Remote Printer Console Main Program

Type **C:\RPCX>RPCX**, and then press the Enter key to start the Remote Printer Console main program.



Do not use this program from a DOS window running under Windows.

14 Using the Windows®-Based Brother MFL-Pro Control Center (Not Available for FAX-4750e)

Brother Control Center

The Brother Control Center is a software utility that pops up on the PC screen whenever paper is placed in the automatic document feeder (ADF). This allows you to quite easily, with very few mouse clicks, access the most frequently used scanning applications. Using the Control Center eliminates the need to manually launch the specific applications.

The Brother Control Center provides three categories of functions:

- 1 Scanning directly to a file, E-mail, word processor or graphic application of choice
- 2 Copy operations
- 3 PC Faxing using the Brother PC Fax software

For FAX-5750e Only:

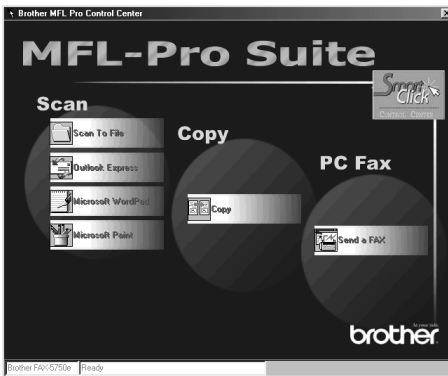

AutoLoad the Brother Control Center

The Control Center is initially configured to automatically load each time Windows® is started. When the Control Center is loaded, the Control Center icon will appear in the task bar. If you don't want the Control Center to load automatically, you can turn off AutoLoad.

If the Control Center icon does not appear in your task bar, you will have to install this software.

From the **Start** menu select **Programs, Paper Port**, and then click **Brother Smart UI PopUp**.

How to Turn Off AutoLoad

- 1 Left-click the Control Center icon, and then click **Show**.
- 2 When the Control Center icon appears, left-click the Smart Click Control Center button. A dialogue box with a check box labeled "AutoLoad Pop-up" will appear:

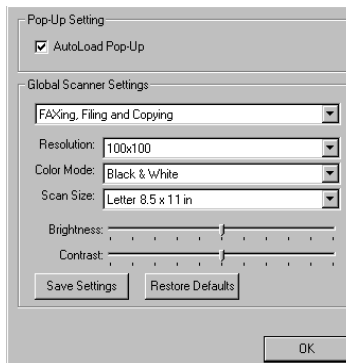



- 3 Uncheck the AutoLoad Pop-Up option.

Brother Control Center Features

Auto Configuration

During the installation process the Control Center checks your system to determine the default applications for E-mail, word processing and graphics viewer/editor. For example, if you are using Outlook as your default E-mail application, the Control Center automatically will create a link and a scanning application button for Outlook.

You can change a default application by right-clicking any of the scan buttons in the Control Center and selecting a different application. For example,

you can change a scan button from MS Word  to MS Word Pad  by changing the application that is listed for the Word Processor.



Scanning Operations

Scan to File—allows you to scan directly to a disk file with two mouse clicks. You can change the file type, destination directory and file name, as needed.

Scan to E-mail—enables you, with just two mouse clicks, to scan a picture or text document directly into an E-mail application as a standard attachment. You have the option of selecting the file type and resolution for the attachment.

Scan to Word Processor—enables you to scan a text document, run ScanSoft TextBridge OCR and insert the text original (not graphic image) into a word processing file with just two mouse clicks. You have the option of selecting the destination word processing program, such as Word Pad, MS Word, Word Perfect, etc.

Scan to Graphic Application—allows you to scan an image directly into any graphic viewer/editor application. You can select the destination application, such as MS Paint or Corel PhotoPaint.

Copy Operations

Copy—allows you to use the PC and any Windows® printer driver for enhanced copy functions. You can scan the page on the Brother machine and print the copies using any of the features of the Brother printer driver—**OR**—you can direct the copy output to any standard Windows® printer driver installed on the PC.

PC Fax Operation

Send a Fax—allows you to scan a picture or text original and automatically send the image as a fax from the PC using the Brother MFL Pro fax software.

Scanner Settings for Scan, Copy and PC Fax Buttons

When the Pop-Up screen is displayed, you can access the Scanner Settings window.

Click the Smart Click  icon at the top right of the Brother Control

Center screen—**OR**—Click the **Modify Settings...** button on any of the Configuration screens.

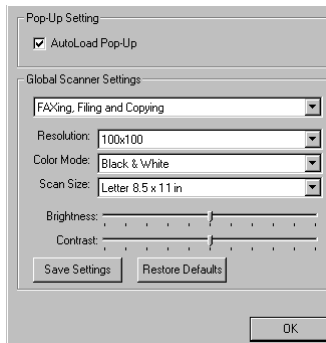

Global Settings

AutoLoad Pop-Up—Click this checkbox if you want Brother MFL Control Center to load when you boot your computer.

Setting Up the Scanner Configurations

The Pop-Up application stores eight different scanning modes. Each time you scan an original, you will choose the most appropriate scanning mode from the following:

Faxing, Filing and Copying

Text for OCR

Photos

Photos (High Quality)

Photos (Quick Scan)

Custom

Draft Copy

Fine Copy

Each mode has its own set of stored settings. You can keep the factory default settings or change them at any time:

Resolution—Select the scanning resolution you most frequently use.

Color Mode—From the pull-down list, select

Scan Size—From the pull-down list, select

Brightness—Slide the adjuster from 0% to 100%

Contrast—Slide the adjuster from 0% to 100%

Click **OK** to save your changes. If you make a mistake or later decide to return to the original default setting, just click the **Restore Defaults** button when the scanning mode is displayed.

To Access the Scanner Configuration Screen:

- 1 Place the original in the ADF.
- 2 Right-click the appropriate Control Center button to display *Configurations...*, then click it. The configuration screen for that **Control Center** button will appear.
- 3 To save your settings, press the **OK** button—**OR**—To return to the factory default settings, press the **Restore Defaults** button.

Perform an Operation from the Control Center Screen

If you see this screen it means you left-clicked a button in the Control Center window without first placing an original in the ADF.

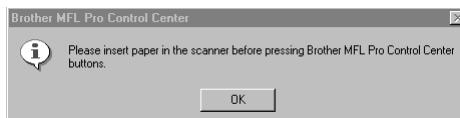

Place the original in the Brother machine's ADF, and then click **OK** to return to the Control Center screen.

Scan to File



Scanner Settings

From the pull-down list, select the scanning mode that is appropriate for the type of file: Faxing, Filing and Copying; Text for OCR; Photos; Photos (High Quality); Photos (Quick Scan); Custom; Draft Copy or Fine Copy.

To change any of the settings for that mode, click the **Modify Settings...** button.

Destination Folder

PaperPort Folder—Select this checkbox to scan the original into your PaperPort folder.

Other Folder—Select this checkbox, to scan the original as another file type and/or into another directory/folder.

File—If you selected Other Folder, from the pull-down list select the type of file:

- PaperPort Files (*.MAX)*
- Self Viewing Files (*.EXE)*
- PaperPort 5.0 Files (*.MAX)*
- PaperPort 4.0 Files (*.MAX)*
- PaperPort 3.0 Files (*.MAX)*
- Windows Bitmap (*.BMP)*
- PC Paintbrush (*.PCX)*
- Multi-page PCX (*.DCX)*
- JPEG Image Files (*.JPG)*
- TIFF-Uncompressed (*.TIF)*
- TIFF Group 4 (*.TIF)*
- TIFF Class F (*.TIF)*
- Multi-Page TIFF-Uncompressed (*.TIF)*
- Multi-Page TIFF Group 4 (*.TIF)*
- Multi-Page TIFF Class F (*.TIF)*
- PDF Files (*.PDF)*
- Portable Network Graphics (*.PNG)*
- FlashPix (*.FPX)*
- HFX Fax Files (*.HFX)*

To Search your system for the directory and folder you want, click the **Browse...** button. Click **OK** to save your settings.

Scan to E-mail

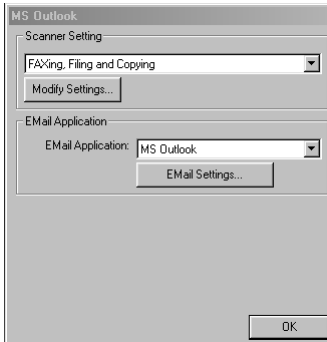

Scanner Settings

From the pull-down list, select the scanning mode that is appropriate for the type of file: Faxing, Filing and Copying; Text for OCR; Photos; Photos (High Quality); Photos (Quick Scan); Custom; Draft Copy or Fine Copy.

To change any of the settings for that mode, click the **Modify Settings...** button.

E-mail Application

E-mail Application—From the pull-down list, select your E-mail application.

E-mail Settings—Click the **EMail Settings...** button to set up links.

The Links Preferences window will appear:



File Attachments

Do not convert files—Click this checkbox if you do not want to change the file type of attachments. The Conversion Options will not be available (grayed).

Convert MAX files only—Click this checkbox if you want to convert only attachments that are PaperPort files.

Convert all files when possible—Click this checkbox if you want to change the file type of all attachments.

Conversion Options

Format

Combine all files into one file when possible—Click this checkbox to combine all files of the same type into one file.

(For Brother Color Models Only)

Convert non-image files to color—Click this checkbox to convert all files that have been processed through OCR to color.

Show QuickSend Menu

Click this checkbox if you want the Select QuickSend Recipient window to be displayed when you choose Scan to E-mail. This feature works only with MAPI type E-mail applications, such as Microsoft Exchange, Microsoft Outlook and Eudora.

QuickSend List

You can create a list of Email names and addresses for quick selection.

To add a name(s) to your QuickSend list, click the **New** button. Your Email phone book listing will be displayed, so you can select stored names or create new ones:

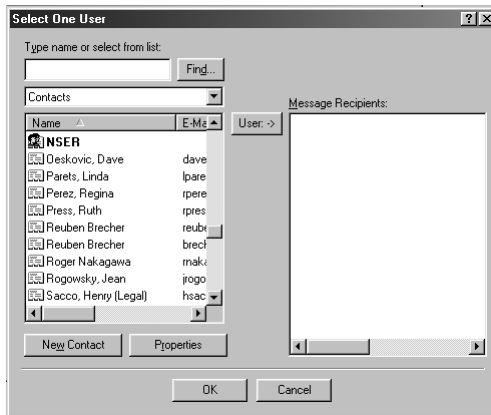

Highlight the name(s) you want to add to your list, and then click the **User** button. Click **OK** to return to the Link Preference window.

To remove a name from the QuickSend list, in the Link Preference window highlight the name and click the **Delete** button.

Scan to Word Processor



Scanner Settings

From the pull-down list, select the scanning mode that is appropriate for the type of file: Faxing, Filing and Copying; Text for OCR; Photos; Photos (High Quality); Photos (Quick Scan); Custom; Draft Copy or Fine Copy.

To change any of the settings for that mode, click the **Modify Settings...** button.

Word Processor

Word Processor—From the pull-down list, select the word processor you want to use.

Click the **Link Settings...** button to display a screen to set up a link to the version of OCR and document format that you want to use:

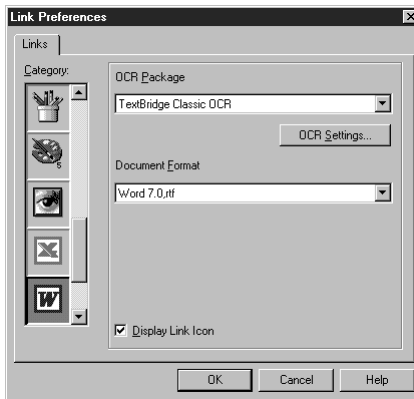

OCR Package—From the pull-down list, select *TextBridge Classic OCR* if you want to use the OCR package that was installed with the Brother software.

Click the **OCR Settings...** button to choose how the OCR application will read the pages you scan into your word processor application.

The Preferences window will appear:



Select your setting and click **OK**.

- *Auto Orientation*—Check this checkbox if you want your word processor application to read the page as it is set up.
- *Decolumnized Output*—Check this checkbox if you want your word processor application to read across the entire page from left to right.
- *Document Format*—From the pull-down list, select the file format you want to use for your word processor or text documents.

User-Defined Button

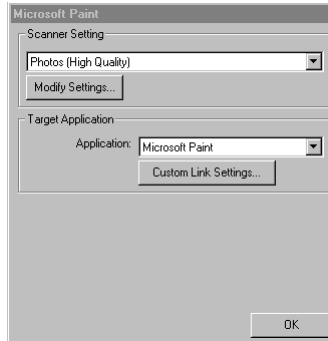

Scanner Settings

From the pull-down list, select the scanning mode that is appropriate for the type of file: Faxing, Filing and Copying; Text for OCR; Photos; Photos (High Quality); Photos (Quick Scan); Custom; Draft Copy or Fine Copy.

To change any of the settings for that mode, click the **Modify Settings...** button.

Target Application

Application—From the pull-down list, select the application you want to add to this Pop-Up screen.

Click the **Custom Link Settings...** button to set up links for your user-defined application.

Copy

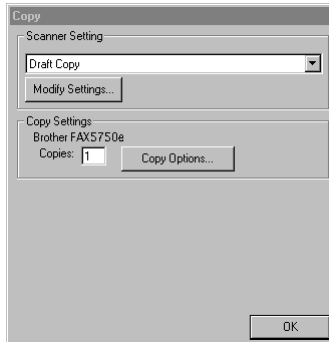

Scanner Settings

From the pull-down list, select the scanning mode that is appropriate for the type of file: Draft Copy or Fine Copy.

To change any of the settings for that mode: Faxing, Filing and Copying; Text for OCR; Photos; Photos (High Quality); Photos (Quick Scan); Custom, click the **Modify Settings...** button.

Copy Settings

Brother FAX-5750e

Copies—Enter the number of copies you want to print.

To change the copy options, click the **Copy Options...** button.

Click the **OK** button to save your Copy settings.

Send a Fax



Scanner Settings

From the pull-down list, select the scanning mode that is appropriate for the type of file: Faxing, Filing and Copying; Text for OCR; Photos; Photos (High Quality); Photos (Quick Scan); Custom; Draft Copy or Fine Copy.

To change any of the settings for that mode, click the **Modify Settings...** button.

Fax Settings

Brother PC-Fax

FAX Resolution—Fine (200 × 200).

To change the fax options, click the **FAX Options...** button.

Click the **OK** button when you are ready to save your FAX settings.

The Brother PC-FAX Properties screen appears:

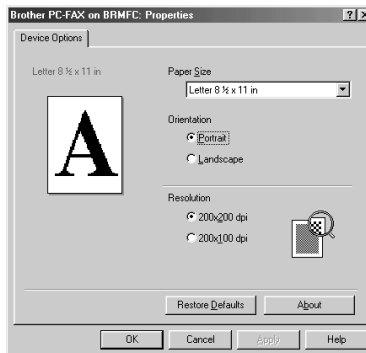

Select the *Paper Size and Orientation* (Portrait or Landscape) and click **OK**.

To return to the factory default settings, click the **Restore Defaults** button.

15 How to Scan Using Windows®

 For FAX-5750e: See *Scanning and Using ScanSoft™ PaperPort® and TextBridge® OCR*, on page 15-5.

For FAX-4750e: How to Access the Scanner

To choose the Brother Multi-Function Link® Pro as your scanner driver, select it under the “Select scanner”—**OR**—“Select source” option in your software.

The Multi-Function Link® Pro Scanner Setup dialog box will appear:

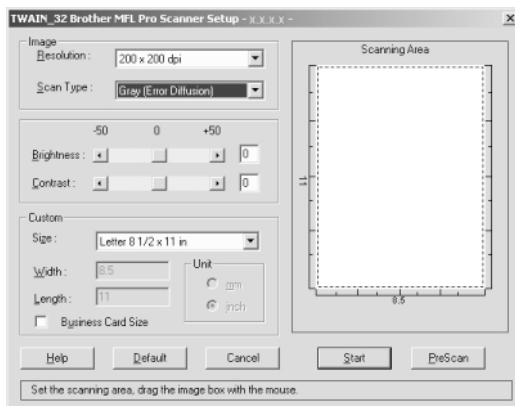

PreScanning an Image

PreScanning allows you to scan an image quickly at a low resolution. A thumbnail version of the image will appear in the Scanning Area. This is only a preview of the image so you can see how it will look. The PreScan button is used to preview an image for cropping any unwanted portions from the image. When you are satisfied with the preview, select the **Start** button to scan the image.

- 1 Insert document face down in document feeder of the machine.

2 Select the **PreScan** button:

The entire document will be scanned into the PC and will appear in the Scanning Area of the Scanner window.

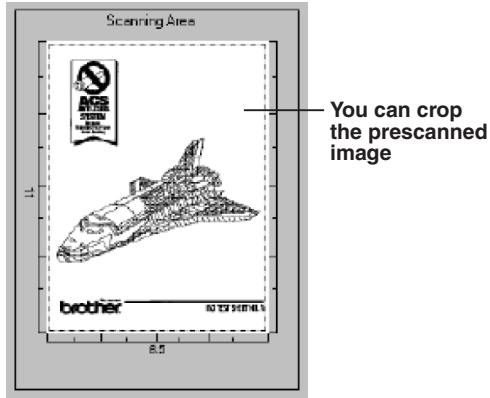

3 To crop a portion of the document to be scanned, drag any side or corner of the dotted outline in the Scanning Area with the left mouse button. Adjust the dotted outline until it surrounds only the portion of the document you wish to scan.

4 Place document in the document feeder of the machine again.

5 Adjust the settings for Resolution, Color Type (Gray Scale), Brightness, Contrast, and Size in the Scanner Setup window, as needed.

6 Select the **Start** button.

This time only the selected area of the document will appear in the PaperPort® window.

7 In the PaperPort® window, use the options available in the Markups pull-down menu and the Crop option in the Options pull-down menu to refine the image.

Scanning a Document into Your PC

1 Insert document(s) face down in the document feeder of the machine.

2 Adjust the following settings, if needed, in the Scanner Setup window:

- Resolution
- Gray Scale (Black & White, Gray [Error Diffusion], True Gray)
- Brightness
- Contrast
- Size

3 Select the **Start** button from the Scanner window.

When scanning is completed, close the scanner window. The PaperPort® screen will appear showing the image you scanned highlighted in red.

Settings in the Scanner Window

Image

Resolution

Resolution: Select the scanning resolution from the Resolution drop down list. Higher resolutions take more memory and transfer time, but can achieve a finer scanned image.



When the setting is True Gray, 200 × 100 dpi and 200 × 400 dpi is not available.

Gray Scale

Gray Scale: Set the image Type to Black & White for text or line art. For photographic images, set the image type to Gray (Error Diffusion) or True Gray.

Gray (Error Diffusion) is used for documents that contain photographic images or graphics. (Error Diffusion is a method for creating simulated gray images by placing black dots in a specific matrix instead of true gray dots.)

256 True Gray mode is used for documents containing photographic images or graphics. This mode requires the most memory and longest transfer time.

Brightness

Brightness: Adjusting the brightness settings to obtain the best image. The Brother Multi-Function Link[®] Pro offers 100 brightness settings (-50 to 50). The default value is 0, representing an “average” setting.

You can set the brightness level by dragging the slider to the right to lighten the image or to the left to darken the image. You can also type a value in the box to set the settings.

If the scanned image is too light, set a lower brightness value and scan the document again.

If the image is too dark, set a higher brightness value and scan the document again.

Contrast

The contrast setting is adjustable only when you have selected one of the gray scale settings, but it is not available when Black & White is selected as the gray Scale.

Increasing the contrast level (by dragging the slider to the right) emphasizes dark and light areas of the Image, while decreasing the contrast level (by dragging the slider to the left) reveals more detail in gray areas. Instead of using the slider, you can type a value in the box to set the contrast.

Custom Size

Set the Size to one of the following:

- Letter (8 1/2 × 11 in.)
- A4 (210 × 297 mm.)
- Legal (8 1/2 × 14 in.)
- A5 (148 × 210 mm.)
- B5 (182 × 257 mm.)
- Executive (7 1/4 × 10 1/2 in.)
- Business Card (60 × 90 mm.)
- Custom (User adjustable from 0.35 × 0.35 in. to 8.5 × 14 in.)

After you select a custom size, you can adjust the scanning area further by using the left mouse button to drag the dotted outline of the scanning area. This is required when you want to crop an image when scanning.

Business Card Size

To scan business cards, select the Business Card (60 × 90 mm.) size setting and place the business card at the top center of a carrier sheet.



Carrier sheets are available from your Dealer.

When scanning photographs or other images for use in a word processor or other graphics application, you should try different settings for the contrast, mode and resolution to see which settings best suit your needs.

For FAX-5750e: Scanning and Using ScanSoft™ PaperPort® and TextBridge® OCR



ScanSoft Paper Port and TextBridge is not available for FAX-4750e.

ScanSoft™ Paper Port® for Brother is a document management application. You will use PaperPort® to view incoming faxes and scanned documents. PaperPort® has a sophisticated, yet easy-to-use, filing system that will help you organize your documents. It allows you to combine or “stack” documents of different formats for printing, faxing or filing. PaperPort® can be accessed through the PaperPort® program group. See *On-Line Documentation for Multi-Function Link® Pro* on the CD-ROM.

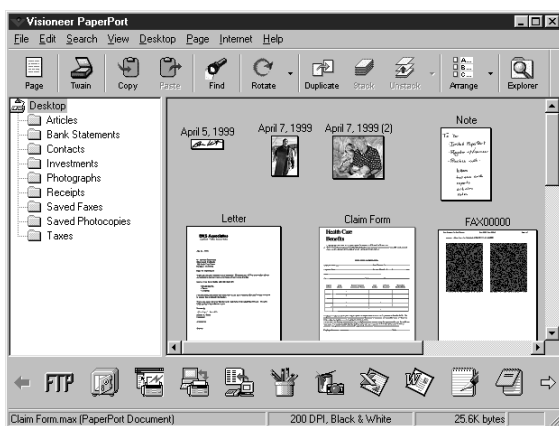

The complete ScanSoft™ PaperPort® Owner’s Manual, including ScanSoft™ TextBridge® OCR, is in the On-Line Documentation on the CD-ROM. This chapter is only an introduction to the basic operations.

When you install Multi-Function Link® Pro, ScanSoft™ PaperPort® for Brother and ScanSoft™ TextBridge® OCR are installed with it automatically.

Viewing Items in PaperPort®

PaperPort® provides several ways to view items: **Desktop View** displays a **thumbnail**, a small graphic that represents each item in a Desktop or folder. Items in the selected folder appear on the PaperPort® Desktop. You can see PaperPort® items (MAX files) and non-PaperPort® items (files created using other applications).

Non-PaperPort® items include an icon that indicates the application that was used to create the item; a non-PaperPort® item is represented by a small rectangular thumbnail and not an actual image.

Page View displays a close-up of a single page and you can open a PaperPort® item by double-clicking on it. As long as you have the appropriate application on your computer to display it, you can also double-click a non-PaperPort® item to open it.

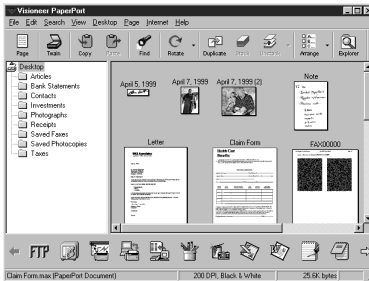

Desktop View displays items as thumbnails

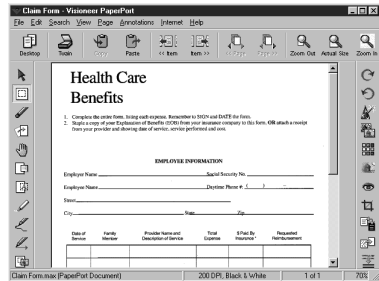

Page View displays each item as a full page

Organizing Your Items in Folders

PaperPort® has an easy-to-use filing system for organizing your items. The filing system consists of folders and items that you select to view in Desktop View. An item can be a PaperPort® item or a non-PaperPort® item:

- Folders are arranged in a “tree” structure in the Folder View. You use this pane to select folders and view their items in Desktop View.
- You can simply drag and drop an item onto a folder. When the folder is highlighted, release the mouse button and the item is stored in that folder.
- Folders can be “nested”—that is, stored in other folders.
- When you double-click a folder, its items (both PaperPort® MAX files and other files) appear on the Desktop.
- You can also use Windows® Explorer to manage the folders and items shown in Desktop View.

Quick Links to Other Applications

PaperPort® automatically recognizes many other applications on your computer and creates a “working link” to them. The Link Bar at the bottom of Desktop view shows icons of those linked applications. To use a link, drag an item onto one of the icons to start the application represented by the icon. A typical use of the Link Bar is to select an item and then fax it.

This sample Link Bar shows several applications with links to PaperPort®.



If PaperPort® does not automatically recognize one of the applications on your computer, you can manually create a link using the **Create New Link** command. (See *PaperPort® Help* for more information about creating new links.)

ScanSoft™ TextBridge® OCR Lets You Convert Image Text to Text You Can Edit

Software by:



ScanSoft™ TextBridge® OCR is automatically installed with PaperPort® when you install Multi-Function Link® Pro on your computer.

PaperPort® can quickly convert the text on a PaperPort® item (which is really just a picture of the text) into text that you can edit with a word processing application. PaperPort® uses the optical character recognition application ScanSoft™ TextBridge, which comes with PaperPort®—**OR**—PaperPort® uses your application if it is already on your computer. You can convert the entire item, or by using the **Copy As Text** command, you can select only a portion of the text to convert.

Dragging an item onto a word-processing link icon starts PaperPort®’s built-in OCR application, or you can use your own OCR application.



How to Access the Scanner

To choose the Brother Multi-Function Link® Pro as your scanner driver, select it under the “Select scanner”—**OR**—“Select Source” option in your software.

From the PaperPort® window, select **Acquire** from the File drop-down menu or select the **TWAIN** or **Scan** button. The Multi-Function Link® Pro Scanner Setup dialog box will appear:

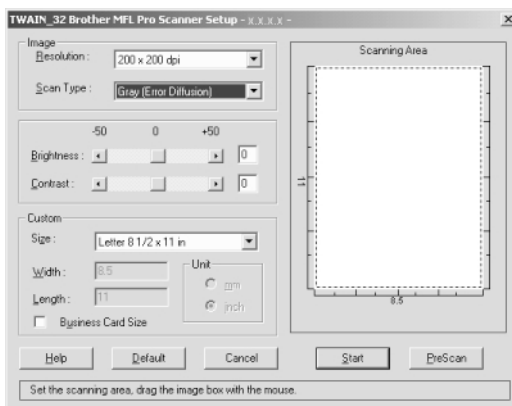

PreScanning an Image

PreScanning allows you to scan an image quickly at a low resolution. A thumbnail version of the image will appear in the Scanning Area. This is only a preview of the image so you can see how it will look. The PreScan button is used to preview an image for cropping any unwanted portions from the image. When you are satisfied with the preview, select the **Start** button to scan the image.

- 1 Insert document face down in document feeder of the machine.

2 Select the **PreScan** button:

The entire document will be scanned into the PC and will appear in the Scanning Area of the Scanner window.

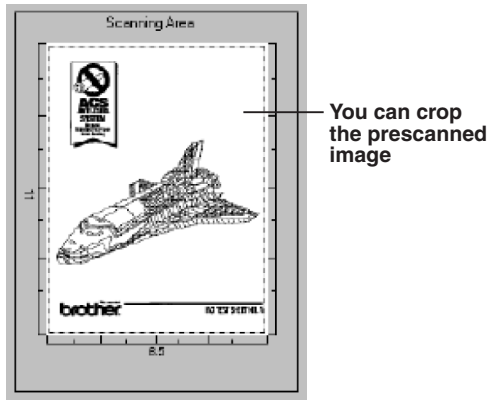

3 To crop a portion of the document to be scanned, drag any side or corner of the dotted outline in the Scanning Area with the left mouse button. Adjust the dotted outline until it surrounds only the portion of the document you wish to scan.

4 Place document in the document feeder of the machine again.

5 Adjust the settings for Resolution, Scan Type (Gray Scale), Brightness, Contrast, and Size in the Scanner Setup window, as needed.

6 Select the **Start** button.

This time only the selected area of the document will appear in the PaperPort® window.

7 In the PaperPort® window, use the options available in the Markups pull-down menu and the Crop option in the Options pull-down menu to refine the image.

Scanning a Document into Your PC

1 Insert document(s) face down in the document feeder of the machine.

2 Adjust the following settings, if needed, in the Scanner Setup window:

- Resolution
- Gray Scale (Black & White, Gray [Error Diffusion], True Gray)
- Brightness
- Contrast
- Size

3 Select the **Start** button from the Scanner window.

When scanning is completed, close the scanner window. The PaperPort® screen will appear showing the image you scanned highlighted in red.

Settings in the Scanner Window

Image

Resolution

Resolution: Select the scanning resolution from the Resolution drop down list. Higher resolutions take more memory and transfer time, but can achieve a finer scanned image.



When the setting is True Gray, 200 × 100 dpi and 200 × 400 dpi is not available.

Gray Scale

Gray Scale: Set the image Type to Black & White for text or line art. For photographic images, set the image type to Gray (Error Diffusion) or True Gray.

Gray (Error Diffusion) is used for documents that contain photographic images or graphics. (Error Diffusion is a method for creating simulated gray images by placing black dots in a specific matrix instead of true gray dots.)

256 True Gray mode is used for documents containing photographic images or graphics. This mode requires the most memory and longest transfer time.

Brightness

Brightness: Adjusting the brightness settings to obtain the best image. The Brother Multi-Function Link[®] Pro offers 100 brightness settings (-50 to 50). The default value is 0, representing an “average” setting.

You can set the brightness level by dragging the slider to the right to lighten the image or to the left to darken the image. You can also type a value in the box to set the settings.

If the scanned image is too light, set a lower brightness value and scan the document again.

If the image is too dark, set a higher brightness value and scan the document again.

Contrast

The contrast setting is adjustable only when you have selected one of the gray scale settings, but it is not available when Black & White is selected as the gray Scale.

Increasing the contrast level (by dragging the slider to the right) emphasizes dark and light areas of the Image, while decreasing the contrast level (by dragging the slider to the left) reveals more detail in gray areas. Instead of using the slider, you can type a value in the box to set the contrast.

Custom Size

Set the Size to one of the following:

- Letter (8 1/2 × 11 in.)
- A4 (210 × 297 mm.)
- Legal (8 1/2 × 14 in.)
- A5 (148 × 210 mm.)
- B5 (182 × 257 mm.)
- Executive (7 1/4 × 10 1/2 in.)
- Business Card (60 × 90 mm.)
- Custom (User adjustable from 0.35 × 0.35 in. to 8.5 × 14 in.)

After you select a custom size, you can adjust the scanning area further by using the left mouse button to drag the dotted outline of the scanning area. This is required when you want to crop an image when scanning.

Business Card Size

To scan business cards, select the Business Card (60 × 90 mm.) size setting and place the business card at the top center of a carrier sheet.



Carrier sheets are available from your Dealer.

When scanning photographs or other images for use in a word processor or other graphics application, you should try different settings for the contrast, mode and resolution to see which settings best suit your needs.

You Can Import Items from Other Applications

In addition to scanning items, you can bring items into PaperPort® in a variety of ways and convert them to PaperPort® (MAX) files in several different ways:

- Print to the Desktop View from another application, such as Microsoft Excel.
- Import files saved in other file formats, such as Windows® Bitmap (BMP) or Tag Image File Format (TIFF).

You Can Export Items in Other Formats

You can export or save PaperPort® items in several popular file formats. For Windows® 95/98/98SE, and Windows NT® Workstation Version 4.0, Windows® 2000 Professional and Windows® Me, you can export formats BMP, PCX, DCX, JPG, TIF, PDF, PNG, FPX, HFX, or self-viewing.

Exporting an Image File

- 1** Select the Export command from the File pull-down menu in the PaperPort® window. The Export 'XXXXX' As dialog box will be displayed.
- 2** Select the drive and directory where you want to store the file.
- 3** Enter the new file name and choose the file type or select a name from the File Name text box. (You can scroll through the Directories and File Name listing for prompting.)
- 4** Select the **Save** button to save your file, or **Cancel** to return to the PaperPort® without saving it.



To Uninstall ScanSoft™ PaperPort® and TextBridge OCR

For Windows® 95/98/98SE, and Windows NT® Workstation 4.0, Windows® ME and Windows® 2000 Professional:

Select Start, Settings, Control Panel, Add/Remove Programs and the Install/Uninstall tab. Select PaperPort® from the list and click the Add/Remove button.

16 Setting Up and Using PC-FAX (For Windows® Only)



PC-FAX Send can be downloaded from the Brother Solutions Center for FAX-4750e.

Introduction

This chapter outlines the basics of the Brother software, so you can get started using the Multi-Function Link® Pro software. Detailed installation and setup instructions are in the On-Line Documentation section of the Brother CD-ROM that is included with your MFC.

Check the online **README.WRI** file in the root directory of the CD-ROM for last-minute important information and troubleshooting tips that were not included in the On-Line Documentation.

Multi-Function Link® Pro software for your MFC includes ScanSoft™ PaperPort® for Brother and ScanSoft™ TextBridge®. (See Chapter 15, *How to Scan Using Windows®*.)

Brother Resource Manager

The Brother Resource Manager application must be running for you to use your MFC with your Windows® computer. Multi-Function Link® Pro software and the MFL Pro Printer Driver automatically load the Resource Manager, as needed. The Resource Manager allows the single bi-directional Parallel port on the MFC to simulate a Communications port for faxing and scanning and to simulate a Parallel port for Windows® GDI printing.

FAX Remote Setup

The MFC Remote Setup application allows you to quickly set up your MFC by taking advantage of the ease and speed of programming on your PC. When you access this application, the settings on your MFC will be downloaded automatically to your PC and displayed on your computer screen. If you change the settings, you can upload them directly to the MFC.

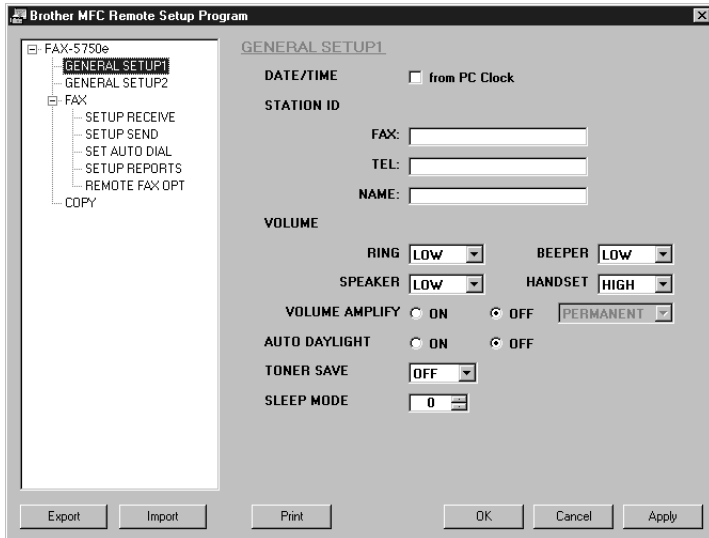

OK

This starts the process of uploading the data to the MFC and exiting the remote setup program. If an error message is displayed enter the correct data again, then click **OK**.

Cancel

This exits the remote setup application without uploading the data to the MFC.

Apply

This uploads the data to the MFC, but does not exit the remote setup application.

Print

This command prints the selected items on the MFC. You can not print the data until it is uploaded to the MFC. Click **Apply** to upload the new data to the MFC and click **Print**.

Export

This command saves the current configuration settings to a file.

Import

This command reads the settings from a file.

PC-FAX Sending (For Windows® Only)

The Brother PC-FAX feature allows you to use your PC to send a file. You can create a file in any application on your PC, and then send it as a PC-FAX. You can even attach a cover page note. All you have to do is set up the receiving parties as Members or Groups in your PC-FAX Address Book. Then you can use the Address Book Search feature to quickly find them to address your fax.

Setting Up User Information

- 1 Access the User Information from the FAX Sending dialog box by clicking



—OR—

From the **Start** menu, select **Programs, Brother, Brother MFL Pro Suite**, and then select **PC-FAX Setup**.

The Brother PC Fax Setup dialog box will appear:

Brother PC-FAX Setup

User Information | Sending | Speed Dial (Facsimile style only)

Name: John Doe

Company: International Spring Board Assoc.

Department: U56

Phone Number: 908-555-1212

Fax Number: 908-555-1212

E-mail: JDoe@springboard.org

Address 1: 123 Rose Hill Driver

Address 2: Potsville, NJ 08888

OK Cancel

- 2 Enter the required User information. This information is required to create the Fax Header and Cover Page.
- 3 To save the User Information, click **OK**.

Setting Up Sending

To access the Sending tab from the Brother PC-FAX Setup dialog box by clicking the **Sending** tab.

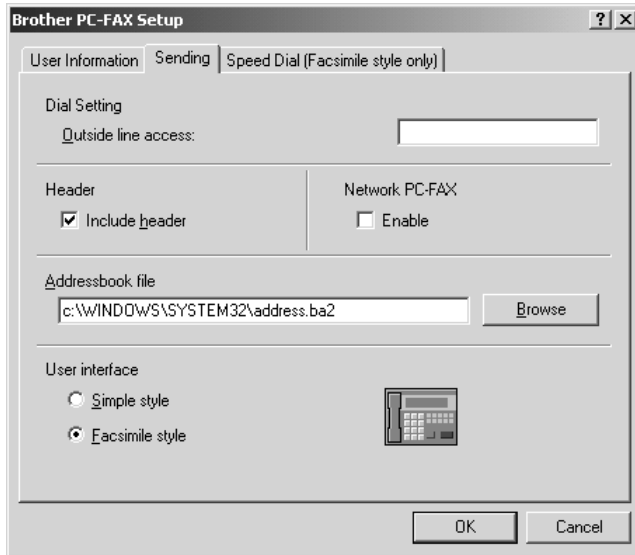

Outside line access

Enter the number needed to access an outside line. This is sometimes required by the local PBX telephone system.

Include header

To add header information to the top of the fax pages being sent, check the Header box.

Address Book file

You can select different database files for use with the Address Book. You must enter the path and file name of the database file or use the Browse button to view the file system to select the file.

Internet PC-FAX

You can use the Internet PC-FAX if you have the optional NC-8100h network board. When you use it, check the Enable box. (See Chapter 15 in NC-8100h User's Guide.)

User interface

To select User Interface for the sending dialog box. You have a choice of the Simple Style or the Facsimile Style.

Simple Style

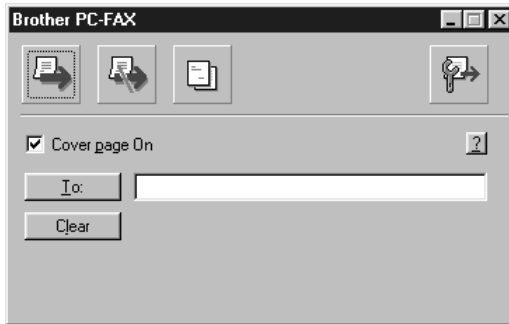

Facsimile Style



Setting Up Speed Dial

Access the Speed Dial tab from the Brother PC-Fax Setup dialog box by clicking the **Speed Dial** tab. (To use the feature you must select the Facsimile Style user interface.)

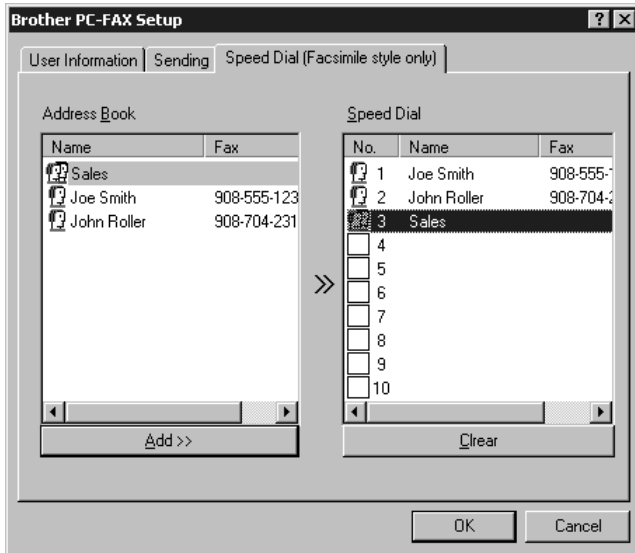

You can register any address or group on one of the ten Speed Dial buttons.

To register an address on a Speed Dial location:

- 1 Click the Speed Dial location you want to program.
- 2 Click the address or group you wish to assign to the Speed Dial location.
- 3 Click the **Add >>** button to program the Speed Dial location.

To clear a Speed Dial location:

- 1 Click the Speed Dial location you want to clear.
- 2 Click the **Clear** button.

The Address Book

From the **Start** menu, select **Programs, Brother, Brother MFL Pro Suite**, and then click **Address Book**.

The Brother Address Book dialog box will appear:

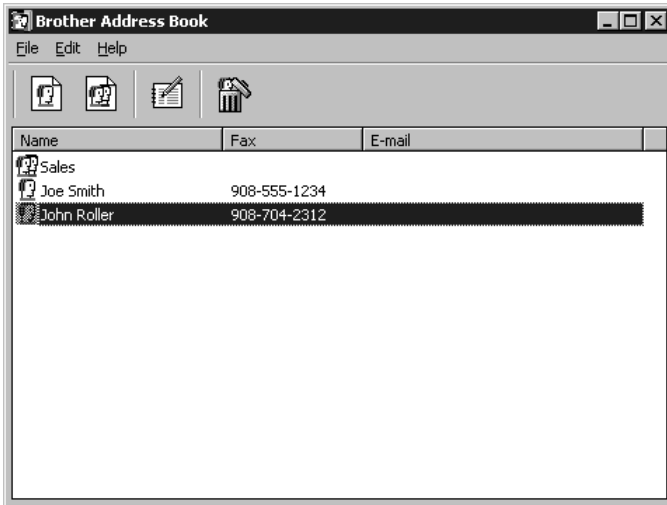

Setting Up a Member in the Address Book

In the Brother Address Book dialog box you can add, edit and delete stored information for members and groups.

- 1 In the Address Book dialog box, click the  icon to add a member. The Brother Address Book Member Setup dialog box will appear:

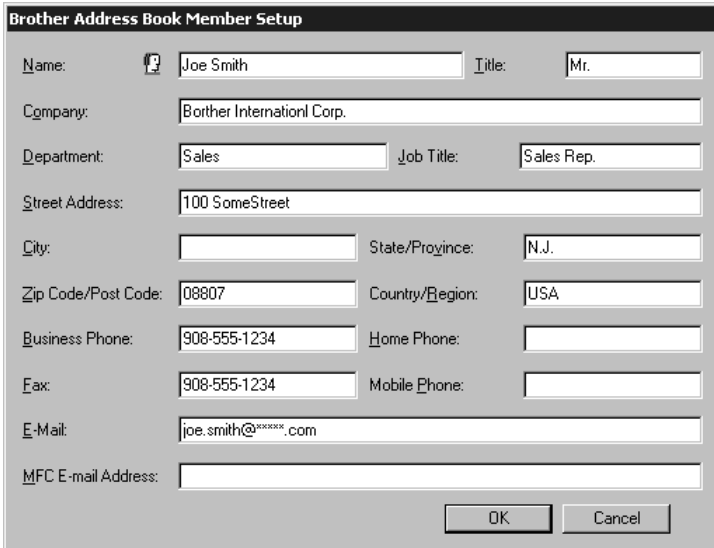

Brother Address Book Member Setup

Name: Title:

Company:

Department: Job Title:

Street Address:

City: State/Province:

Zip Code/Post Code: Country/Region:

Business Phone: Home Phone:

Fax: Mobile Phone:

E-Mail:

MFC E-mail Address:

OK Cancel

- 2 In the Brother Address Book Member Setup dialog box, type the member's information. **Name** and **Fax** are required fields. Click the **OK** button to save the member's information.

Setting Up a Group for Broadcasting

If you repeatedly send the same PC-FAX to multiple recipients, you can combine members into a Group.

- 1 In the Brother Address Book dialog box, click the  icon to create a group. The Brother Address Book Group Setup dialog box appears:

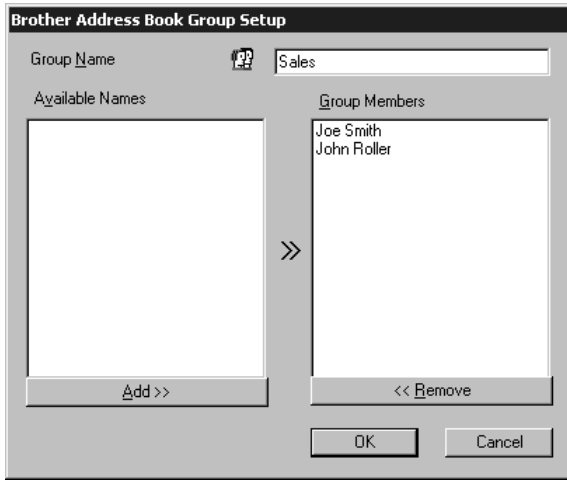

- 2 Type the name of the new group in the **Group Name** field.
- 3 In the Available Names box, select each member to be included in the Group, and then click **Add >>**.
Members you add to the group will be listed in the Group Members box.
- 4 After all the members have been added, click **OK**.

Editing Member Information

To edit a Member or Group:

- 1 Select the Member or Group you want to edit .
- 2 Click the edit  icon.
- 3 Edit the Member or Group information.
- 4 Click **OK** to save your changes.

Deleting a Member or Group

To delete a Member or Group:

- 1 Select the Member or Group you want to delete.
- 2 Click the delete  icon.
- 3 Click OK when the Delete OK? Dialog appears.

Exporting the Address Book

You can export the address book to an ASCII text file (*.csv).

To export the current telephone book:



If you are creating a Vcard, you must first select the member.

- 1 From the Address Book select **File**, point to **Export**, and then click **Text** —**OR**—Click **Vcard** and go to Step 5.
- 2 Select the data fields you wish to Export from the **Available Items** column, and then click **Add >>**.



Select items in the order you want them listed.

- 3 If you are exporting to an ASCII file, select **Divide Character - Tab or Comma**. This selection inserts a Tab or Comma between each data field when it is Exported.
- 4 Select the **OK** button to save the data.

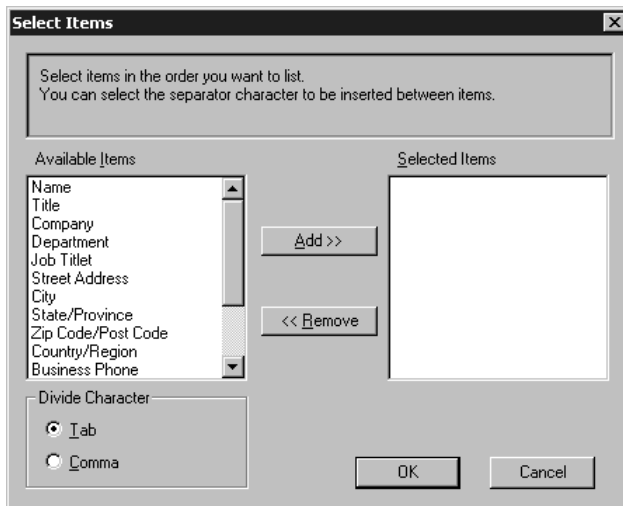

- 5 Type the name of the file, and then select **Save**.

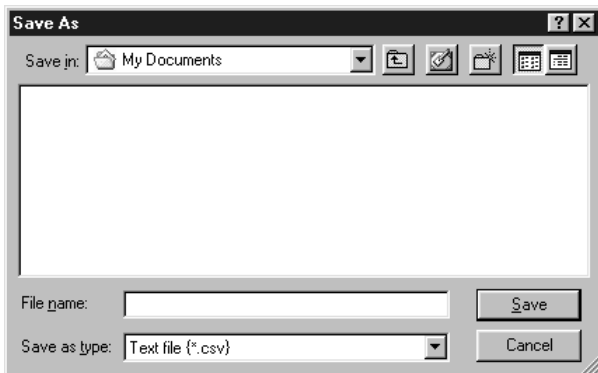

Importing to the Address Book

You can import ASCII text files (*.csv) or Vcards into your Address Book.

To import an ASCII text file:

- 1 From the Address Book select **File**, point to **Import**, and then click **Text**—**OR**—Click **Vcard** and go to Step 5.

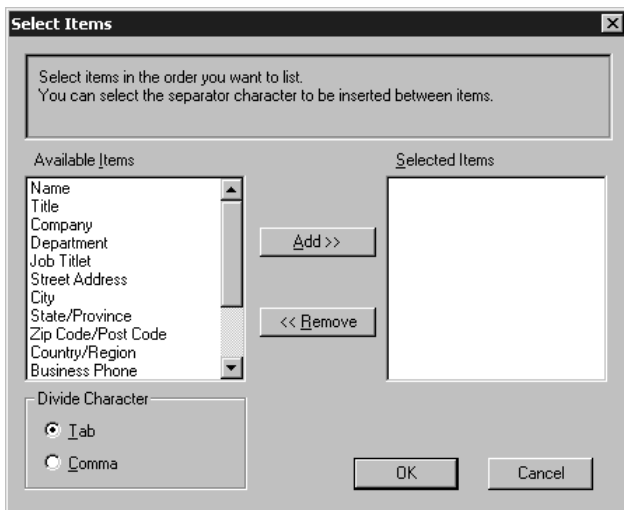

- 2 Select the data fields you wish to Import from the **Available Items** column, and then click **Add >>**.

Note Select items in the order you want them listed.

- 3 Select **Divide Character - Tab or Comma** based on what file format you are importing.
- 4 Select the **OK** button to import the data.

- 5 Type the name of the file, and then select **Open**.

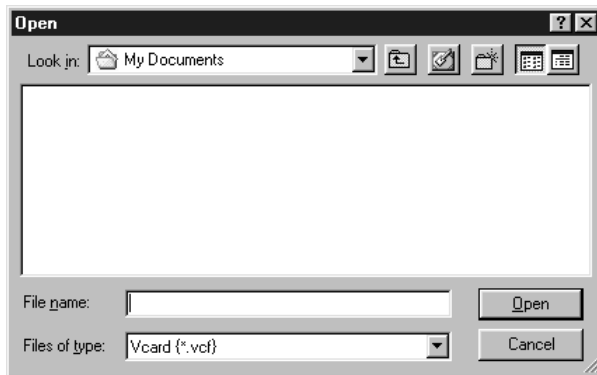

Setting Up Cover Page

Access the Brother PC-FAX Cover Page Setting from the FAX Sending dialog box by clicking . The Brother PC-FAX Cover Page Setup dialog box will appear:

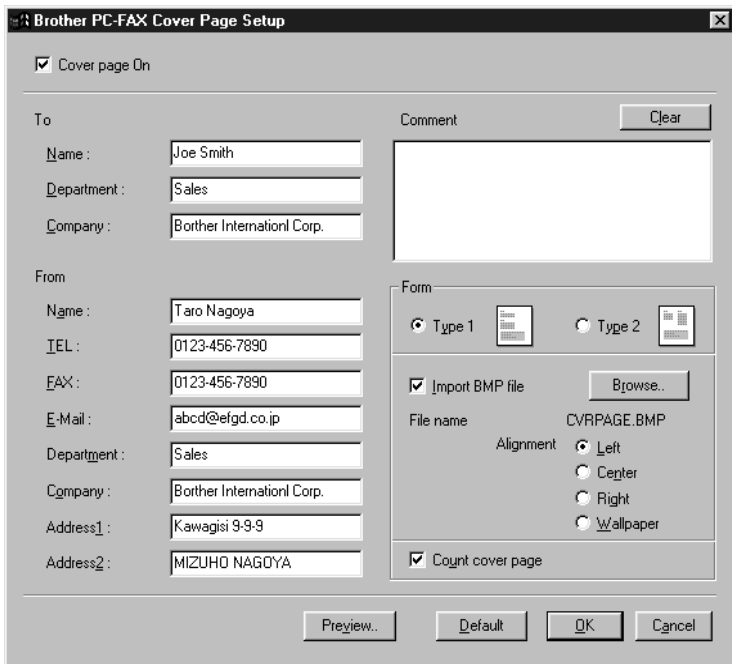

To

You can enter information in each field.



If you are sending a fax to multiple recipients, the recipient information will not be printed on the Cover Page.

From

You can enter information in each field.

Comment

Type the comment you want to add to the cover page.

Select Cover Page Form

Select the cover page form you want.

Import BMP file

You can insert a bitmap file, such as your company logo, in the cover page.

Select the BMP file by using the browse button, and then select the alignment style.

Count Cover Page

When this box is checked, the Cover Page will be included in the page numbering. When this box is not checked, the Cover Page will not be included.

Sending a File as a PC-FAX Using the Simple Style

- 1 Create a file in Word, Excel, Paint, Draw, or any other application on your PC.
- 2 From the **File** menu, select **Print**.

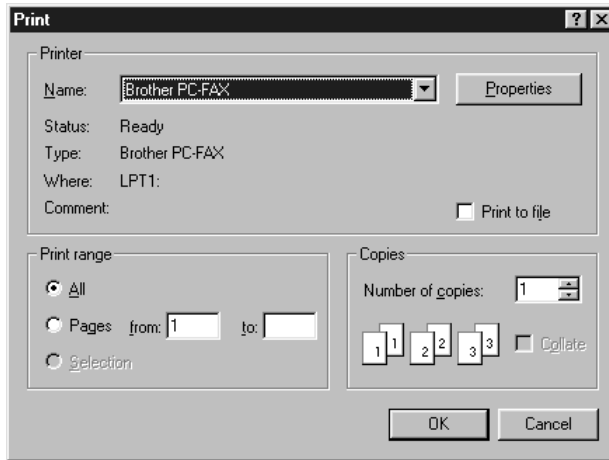

The Print dialog box will appear:

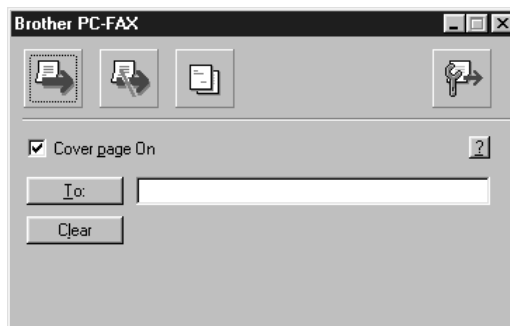

- 3 Select **Brother PC-FAX** as your printer, and then click **OK**.

The FAX Sending dialog box will appear:



- 4 In the **To:** field, type the fax number of the receiving party. You can also use the Address Book to select destination fax numbers. If you made a mistake entering a number, click the **Clear** button to clear all entries.
- 5 To send a Cover Page and note, click the **Cover Page** check box.
- 6 When you are ready to send your fax, click the Send  icon.
- 7 If you wish to cancel the fax, click the  icon.

Sending a File as a PC-FAX Using the Facsimile Style

- 1 Create a file in Word, Excel, Paint, Draw, or any other application on your PC.
- 2 From the **File** menu, select **Print**.
The Print dialog box will appear:

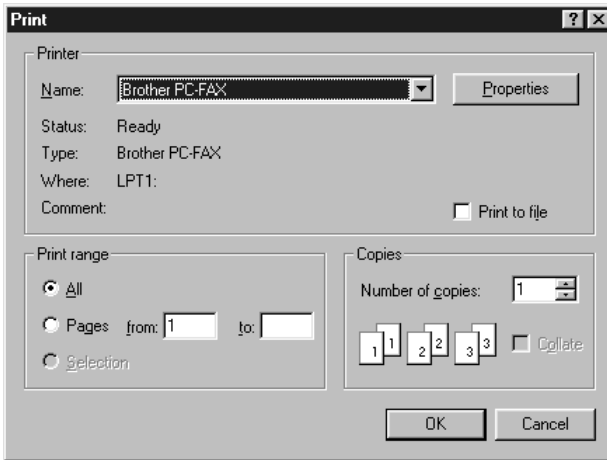

- 3 Select **Brother PC-FAX** as your printer, and then click **OK**.
The FAX Sending dialog box will appear:



- 4** Enter the fax number by using any of the following methods:
 - a. Enter the number using the dial pad.
 - b. Click any of the 10 **Speed Dial** buttons.
 - c. Click the **Address Book** button, and then select a Member or Group from the Address Book.



If you make a mistake you can use the click the **Clear** button to clear all the entries.

- 5** To include a cover page, check the **Cover Page** option. You can also click the **Cover Page** button to create or edit an existing cover page.
- 6** Click **Start** to send the fax.
- 7** If you wish to cancel the fax, click **Stop**.



Redial

If you want to redial a number, click **Redial** button to scroll through the last five fax numbers, and then click **Start**.

17 How to Print, Fax and Scan Using Apple® Macintosh®

For FAX-4750e: Set up Your USB Equipped Apple® Macintosh® with Mac OS 8.5-9.2

Note Before you can connect the Brother machine to your Macintosh®, you must purchase a USB cable that is no longer than 6 feet (1.8 meters).

To work with your Brother machine your USB Equipped Apple® Macintosh® must be set up with Mac OS 8.5-9.2 (The Brother Scanner Driver works only with Mac OS 8.6-9.2)

How to Print Using Brother Printer Driver

To select the Printer:

- 1 From the Apple menu, open the **Chooser**.

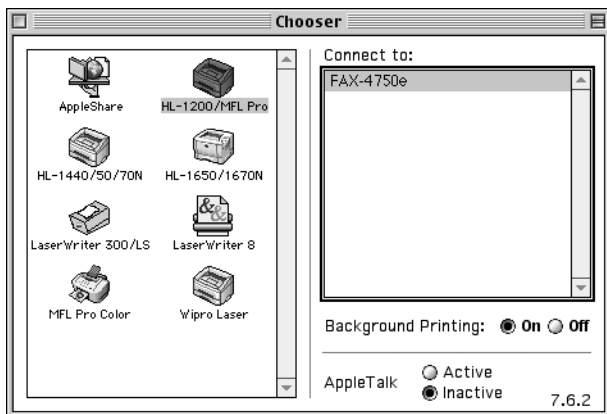

- 2 Click HL-1200/MFL Pro icon. On the right side of the Chooser, click the printer to which you want to print. Close the Chooser.

To print the document:

- 3 From application software such as PaperPort®, click *File menu* and select *Page Setup*. You can change the settings for **Paper Size**, **Orientation** and **Scaling**, and then click **OK**.

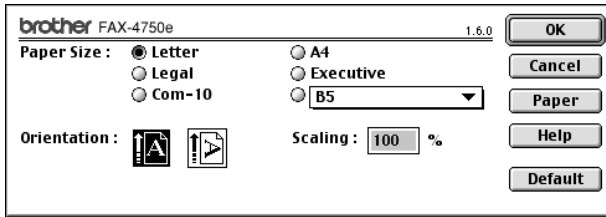

- 4 From application software such as PaperPort, click *File menu* and select *Print*. Click **Print** to start printing.

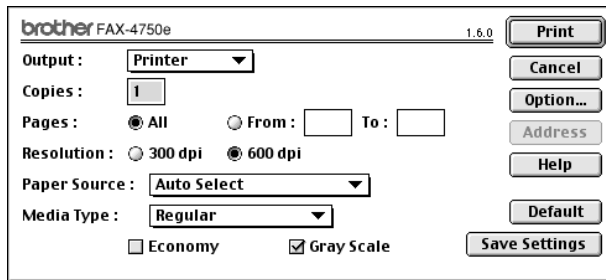

Note If you want to change **Copies**, **Pages**, **Resolution**, **Paper Source** and **Media Type**, select your settings before clicking **Print**.

Option Setup allows you to select **Duplex**.

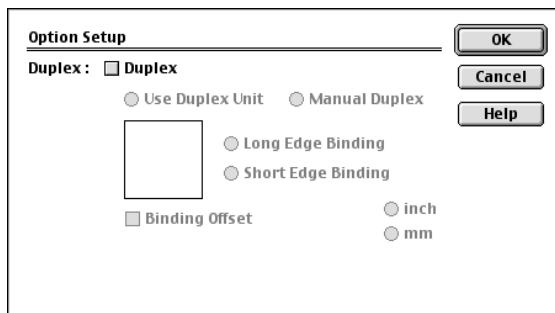

How to Send a Fax from a Macintosh®

You can send a fax directly from your Macintosh® application using the following steps:

- 1 Create a document in a Macintosh application.
- 2 To begin the fax transmission, select **Print** from the **File** menu. The Printer dialog box appears:

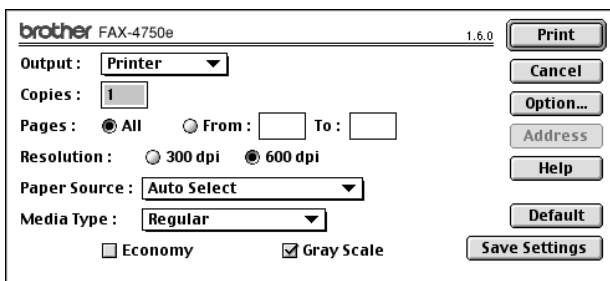

When **Printer** is selected, the top button shows **Print** and the **Address** button is grayed.

- 3 From the **Output** pop-up menu, select **Facsimile**.

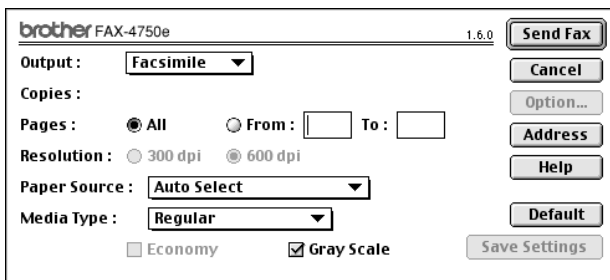

When **Facsimile** is selected, the top button shows **Send Fax** and the **Address** button is available.

4 Click **Send Fax**.

The *Send Fax* dialog box appears:

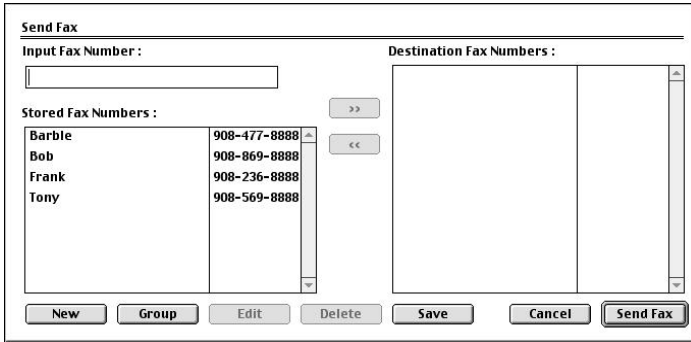

The Address Book dialog box has two list boxes. The left box shows all the previously **Stored Fax Numbers**; the right box will show the **Destination Fax Numbers** as you select them.

5 To address the fax, type a fax number in the **Input Fax Number** box.

—OR—

Select a name/number from the **Stored Fax Numbers** box, and then click . Your recipient will appear in the **Destination Fax Numbers** box.



You can select several stored numbers at once by using the Shift and Ctrl keys.

6 If you want to, you can add your new recipients to the Address Book at this time by clicking **New** to open the Address Book dialog box. (See *Adding a New Member*, page 17-5.)

—OR—

You can add a new group by clicking **Group**. (See *Adding a New Group*, page 17-6.)

7 If you are finished addressing your fax, click **Send Fax**.



To select and send only certain pages of the document, enter the page numbers in the From and To : boxes in the Facsimile dialog box.



If you click Send Fax without addressing your fax, the following error message appears:

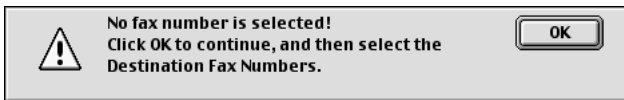

Click **OK** to return to the Send Fax dialog box.

Setting Up Your Address Book

You can add new members and groups to your Address Book, even while you are addressing a fax.

Adding a New Member

- 1 To add a new member to the Address Book, in the Facsimile dialog box click **Address**.

The Address Book dialog box appears:

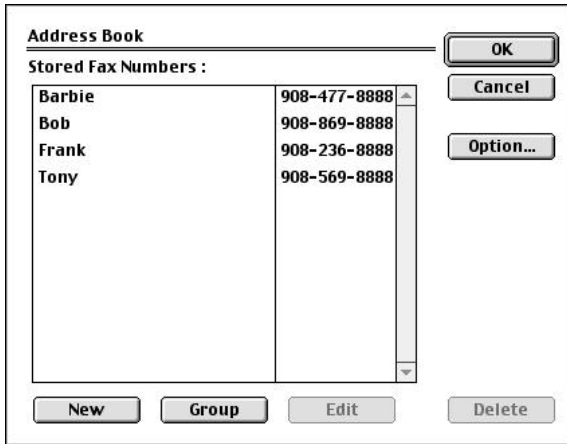

The Address Book dialog box is titled "Address Book". It features a table with two columns: "Name" and "Fax Number". The table contains the following entries:

Name	Fax Number
Barbie	908-477-8888
Bob	908-869-8888
Frank	908-236-8888
Tony	908-569-8888

Below the table are four buttons: "New", "Group", "Edit", and "Delete". To the right of the table are three buttons: "OK", "Cancel", and "Option...".

- 2 Click **New**. The following dialog box appears:

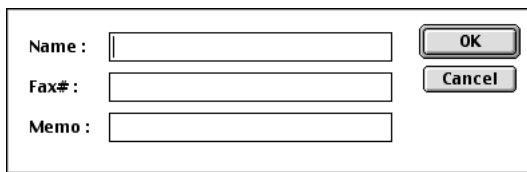

The New Member dialog box contains three input fields and two buttons. The fields are labeled "Name:", "Fax#:", and "Memo:". The "Memo:" field is a larger text area. The buttons are "OK" and "Cancel".

- 3 Type the name and fax number.
- 4 If you want to, you can store a comment in the Memo field if you wish (up to 15 characters).
- 5 Click **OK** to return to the Address Book dialog box.

Adding a New Group

You can set up a group of multiple recipients.

1 Click **Group**.

The Group Setting dialog box appears.

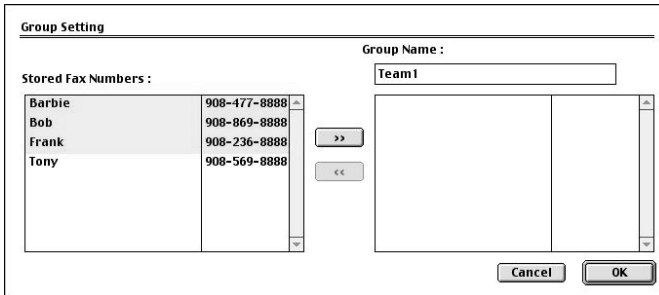

2 In the Group Name field, type a name for your Group.

3 From the **Stored Fax Numbers** box select the recipients for your Group, and then click .

Your selection will appear in the box under the **Group Name** field.

4 Click **OK**.

The Address Book dialog box reappears:

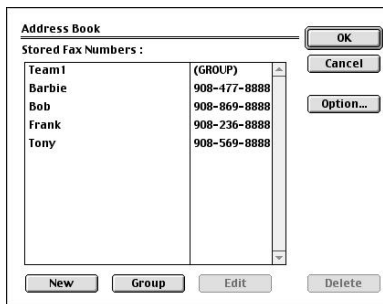

5 Click **OK**.

The Print/Facsimile dialog box reappears:

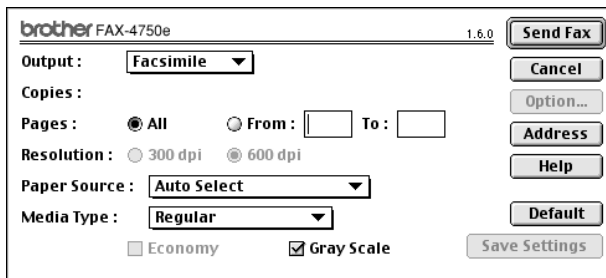

6 If you are ready to send your fax, click **Send Fax**. (Follow the steps on page 17-3 for sending a fax.)

How to Scan Using the Brother TWAIN Scanner Driver

For FAX-4750e Users

The Macintosh® TWAIN Scanner driver can be used with any application that supports the TWAIN specification.

For FAX-5750e Users

The Brother MFC software includes a TWAIN Scanner driver for Macintosh®. This Macintosh® TWAIN Scanner driver can be used with any application that supports the TWAIN specification. You can use PaperPort® for scanning.

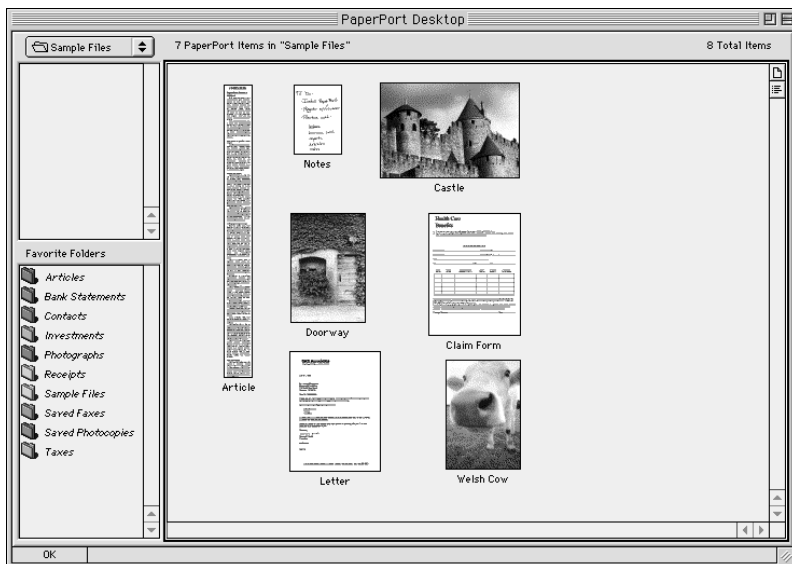

How to Access the Scanner

For FAX-4750e Users

In the application you are using, select the Brother MFL Pro TWAIN Scanner. The method of selection will vary depending on your software application.

For FAX-5750e Users

Run your PaperPort® software. You will see the **PaperPort® icon** in the upper right corner of your screen. The first time you use the Brother TWAIN driver, set it as the default by choosing the *Select Source*, and then click the *PaperPort®* icon. Afterward, for each original you scan, choose *Acquire Image* by clicking the *PaperPort®* icon. The Scanner setup dialog box will appear.

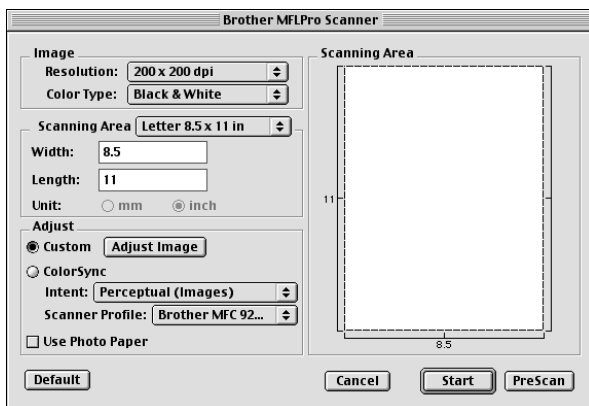

PreScanning an Image

PreScanning allows you to scan an image quickly at a low resolution. A thumbnail version will appear in the Scanning Area. This is only a preview of the image, so you can see how it will look. The PreScan button is used to preview an image for cropping any unwanted portions from the image. When you are satisfied with the preview, click Start to scan the image.

1 Insert the original face down in the ADF.

2 Click **PreScan**.

The entire original will be scanned into your Macintosh G3 or iMac and will appear in the Scanning Area of the Scanner dialog box:

- 3 To scan a portion of the prescanned image, click and drag the mouse to crop it.

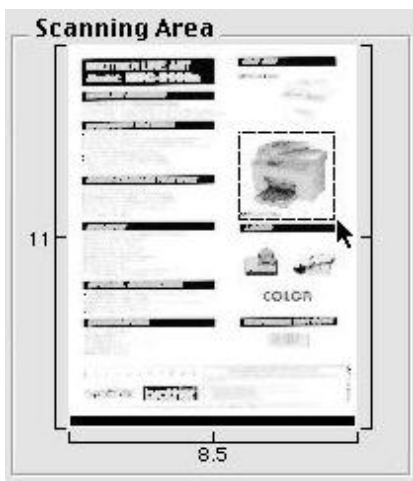

- 4 Insert original in the ADF of the Brother MFC again.
- 5 Adjust the settings for Resolution, Color Type (Gray Scale), Brightness, Contrast, and Size in the Scanner Setup dialog box, as needed.
- 6 Click **Start**.
This time only the selected area of the original will appear in the Scanning Area.
- 7 Use your application Software for editing and refining the image.

Scanning a Document into Your Macintosh

- 1 Place the original in the ADF.
- 2 Adjust the following settings, if needed, in the scanner setup dialog box:
 - *Resolution*
 - *Color Type*
 - *Brightness*
 - *Contrast*
 - *Scanning Area*
- 3 Click **Start**.

When scanning is finished, the image will appear in your graphics application.

Settings in the Scanner Window

Image

Resolution

Choose the scanning resolution from the Resolution pop-up menu. Higher resolutions take more memory and transfer time, but can achieve a finer scanned image. (Each model has different resolutions. See Specification.)

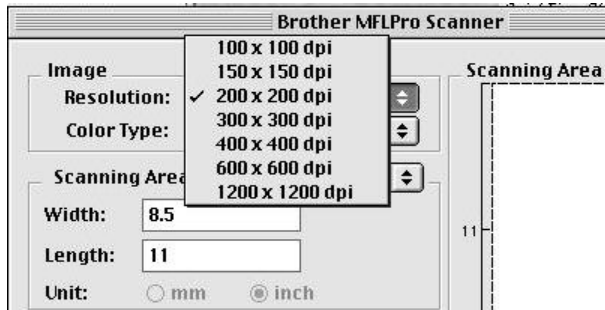

Scanning Area

Set the **Size** to one of the following:

- *Letter* (8.5 × 11 inches)
- *A4* (210 × 297 mm)
- *Legal* (8.5 × 14 inches)
- *A5* (148 × 210 mm)
- *B5* (182 × 257 mm)
- *Executive* (7.25 × 10.5 inches)
- *Business Card* (90 × 60 mm)
- *Custom* (User adjustable from 0.35 × 0.35 inches to 8.5 × 14 inches)

After you choose a custom size, you can adjust the scanning area. Click and hold the mouse button as you drag the mouse to crop the image.

Width: Enter the width of the custom size.

Length: Enter the length of the custom size.

Business Card Size

To scan business cards, select the Business Card size setting (90 × 60 mm) and place the business card at the top center of a carrier sheet.



Carrier sheets are available from your Dealer.

When scanning photographs or other images for use in a word processor or other graphics application, it is a good idea to try different settings for the contrast, mode and resolution to determine which settings look best.

Miscellaneous

Brightness

Adjust the brightness settings to obtain the best image. The Brother TWAIN Scanner driver offers 100 brightness settings (-50 to 50). The default value is 0, representing an “average” setting.

You can set the brightness level by dragging the slider to the right to lighten the image or to the left to darken the image. You can also type a value in the box to set the setting. Click **OK**.

If the scanned image is too light, set a lower brightness value and scan the document again.

If the image is too dark, set a higher brightness value and scan the document again.

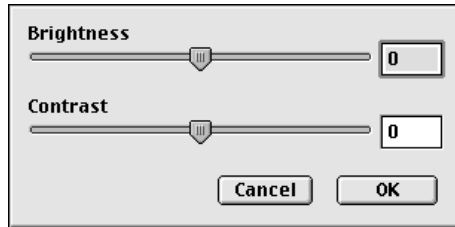

Contrast

The contrast setting is adjustable only when you have selected one of the gray scale settings, but it is not available when Black & White is selected as the Gray Scale.

Increasing the contrast level (by dragging the slider to the right) emphasizes dark and light areas of the Image, while decreasing the contrast level (by dragging the slider to the left) reveals more detail in gray areas. Instead of using the slider, you can type a value in the box to set the contrast. Click **OK**.

18 Optional Accessories

Memory Board (For FAX-4750e and FAX-5750e Only)

The memory board is installed on the main controller board inside the machine. When you add the optional memory board, it increases the performance for both fax and printer operations.

Model Name	Optional Memory
FAX-4750e and FAX-5750e with Standard Memory: 8MB	16MB TECHWORKS 12456-0001
	32MB TECHWORKS 12457-0001

In general, the DIMM must have the following specifications:

Type: 100 pin and 32 bit output

CAS Latency: 2 or 3

Clock Frequency: 66MHz or more

Capacity: 16 or 32MB

Height: 46mm (1.8 inches) or less

Parity: NONE

DRAM Type: SDRAM 4 Bank

Some DIMMs might not work with this machine. For the latest information from Brother, visit:

<http://solutions.brother.com>

Installing the Optional Memory Board

Caution: DO NOT touch the surface of the main board within 15 minutes after turning off the power.

- 1 Disconnect the telephone line cord, unplug the machine power cord from the AC outlet, and then disconnect the interface cable.

Warning: Unplug the power cord before installing (or removing) the memory board.

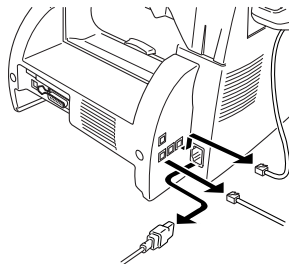

- 2** Remove the screws securing the rear cover and remove the cover.

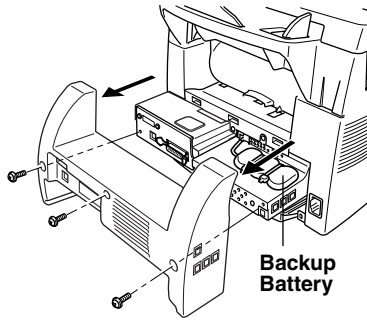

- 3** Remove the screws securing the access plate and remove the plate.

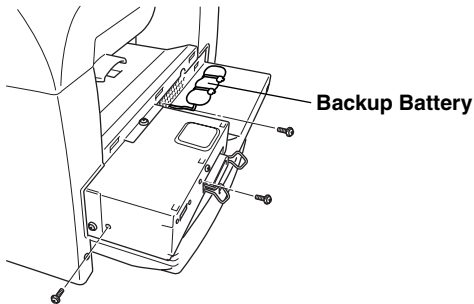

- 4** Disconnect the connector from the backup battery.

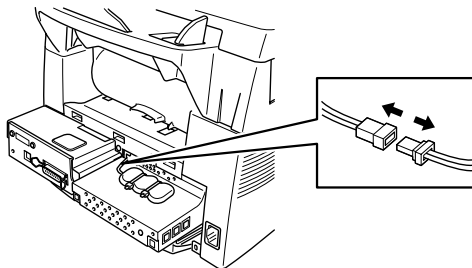

- 5** To install the memory board onto the main controller board, plug the attached spacer into the connectors of the main controller board.

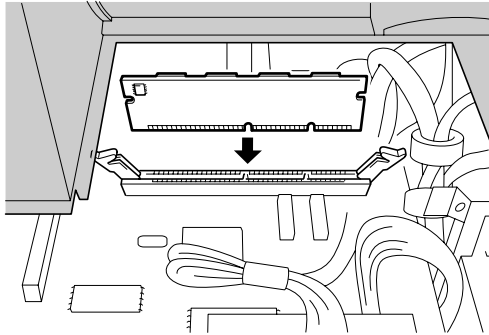

⚠ WARNING

- Hold the memory board by its edges. Do not touch the surface of the board.

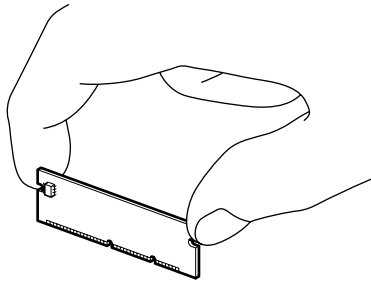

- Make sure the memory board is securely seated on the main controller board.

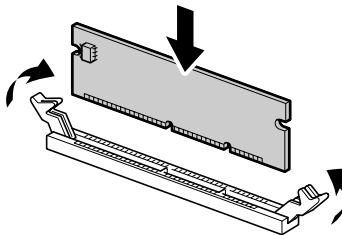

- 6** Reconnect the connector to the backup battery.
- 7** Reinstall the access plate and the rear cover.
- 8** Reconnect the interface cable, and then plug the power cord into the AC outlet.

Paper Cassette #2 (Option for FAX-4750e)

You can purchase the Paper Cassette #2 accessory (**LT400**) to use as a third paper source. Cassette #2 holds up to 250 sheets of 20 lb. (75 g/m²) paper.

Paper Cassette #2:	Holds approx. 250 sheets of 20 lb. (75 g/m ²)
Basis Weight:	16 to 28 lb. (60 to 105 g/m ²)
Caliper:	0.003 to 0.005 inches. (0.08 to 0.13 mm)
Moisture Content:	4% to 6% by weight
Smoothness:	100 to 250 (Sheffield)
We Recommend: Cut sheet:	Xerox 4200 DP 20 lb, Champion Paper One 20 lb, Hammermill Laser Paper 24 lb

Network (LAN) Board (Option for FAX-4750e)

When you add the optional Network (LAN) Board (NC-8100h), you can connect your machine into the network to use the Internet FAX, Network Scanner, Network Printer and Network Management operations.
(See *NC-8100h User's Guide* on the CD-ROM.)

19 Troubleshooting and Routine Maintenance

Troubleshooting

IMPORTANT

For technical and operational assistance, you must call the country where you purchased the machine. Calls must be made *from within* that country.

Error Messages

As with any sophisticated office product, errors may sometimes occur. If this happens, your machine often identifies the problem and displays an error message. The table below explains the most common error messages.

You can correct most problems by yourself. If you need additional help, call the Brother fax-back system.

In USA Only:

1-800-521-2846

Error Messages		
Error Message	Cause	Action
CHANGE DRUM SOON	The drum unit is near the end of its life.	Use the drum unit until you have a print quality problem; then replace the drum unit with a new one.
	The drum counter was not reset.	1. Open the front cover and then press Clear . 2. Press 1 to reset.
CHECK PAPER #1 CHECK PAPER #2	The machine is out of paper or paper is not properly loaded in the paper cassette.	Refill the cassette or remove the paper and load it again.
CHECK PAPER SIZE	When you see this error, the paper in the cassette does not match the paper size you set in Menu, 1, 1 .	Either load the appropriate size paper or change the default setting. (See page 4-1).
COMM. ERROR	A poor quality phone line caused communications error.	Try the call again.
CONNECTION FAIL	The fax machine you polled is not in Polled Waiting mode.	Verify the other party's polling setup.

Error Messages

Error Message	Cause	Action
COOLING DOWN	The temperature of the drum unit or toner cartridge is too hot. The machine will pause its current print job and go into cooling down mode. During the cooling down mode, you will hear the cooling fan running while the display on the machine shows COOLING DOWN .	You must wait and allow the machine to resume printing when it is ready.
COVER OPEN PLS CLOSE COVER	The front cover was not completely closed.	Close the front cover for the drum unit.
DISCONNECTED	The other party or other party's fax machine terminated the call.	Try to fax or receive again or call the other party to see what happened.
CHECK ORIGINAL	Originals did not feed properly or original was too long.	Do not pull paper out until you read Page 19-4.
MACHINE ERROR XX	The machine has a mechanical problem.	Turn the power off. Then call Brother Customer Service at: In USA: 1-800-284-4329 In Canada: 1-877-BROTHER In Montreal: (514) 685-6464
OUT OF MEMORY (May occur when the machine is used as a printer)	The machine memory capacity has been exceeded.	<ul style="list-style-type: none"> • If you have installed the Windows® driver, try again after setting the True Type mode to "Print as Graphics" in the Print menu of your application software. • Reduce the print resolution or reduce the complexity of your document.
NO RESPONSE / BUSY	The number you called does not answer or is busy. Or, you may have reached a number that is not connected to a fax machine.	Check the number and try again.
NOT REGISTERED	The One Touch or Speed Dial number that you accessed is not programmed.	Set up the One Touch or Speed Dial number. (See Pages 7-1 and 7-2.)

Error Messages

Error Message	Cause	Action
PLS OPEN COVER	A page, piece of paper, or paper clip may be jammed inside the machine.	Open the front cover. If you see any jammed paper or other item, gently pull it out, then close the scanner unit. If the error message remains, open and close the front cover again. If the machine cannot reset itself and return to the date and time prompt, it will display MACHINE ERROR XX . Please call Brother Customer Service and tell them the Machine Error number at: In USA: 1-800-284-4329 In Canada: 1-877-BROTHER In Montreal: (514) 685-6464
PAPER JAM	The paper is jammed in the machine.	Do not pull the paper out until you see page 19-4.
TONER EMPTY	Toner cartridge is not installed. —OR— Toner is used up and printing is not possible.	Reinstall the toner cartridge. —OR— Replace the toner cartridge with a new one. (See Page 19-20.)
TONER LOW	If the LCD shows TONER LOW and the Toner Empty LED on the control panel is blinking, you can still print. But the toner is depleted and the machine is telling you that the toner will soon run out.	Order a new toner cartridge now.

Document Jam

The originals did not feed properly, or were too long.

- 1 Lift the control panel.
- 2 Carefully pull the document toward the front of the machine.
- 3 Close the control panel.
- 4 Press **Stop/Exit**.



Paper Jam

Before you can clear a paper jam error, you must find out where the paper is stuck. See the following three types of paper jams.

WARNING

Do not use force to pull the jammed paper from the paper tray because you may damage the machine and cause toner to scatter on the next printed pages.

After you use the machine, some internal parts are extremely **HOT!** When you open the front or the rear cover, never touch the shaded parts shown in the following diagram.

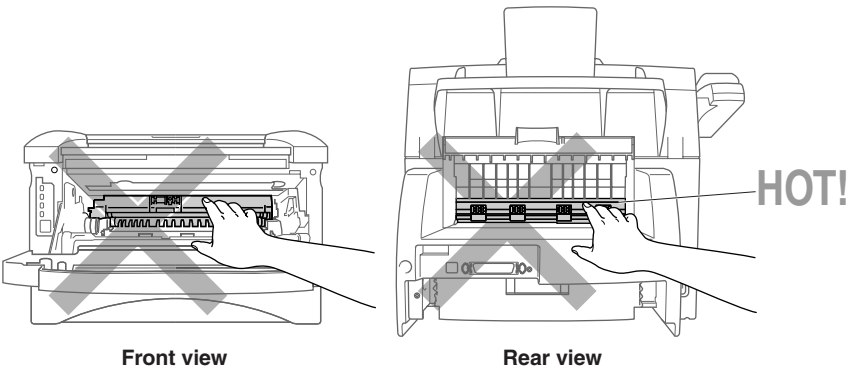

Paper is Jammed in the Paper Cassette

- 1** Pull the paper cassette out of the machine.
- 2** Remove any crinkled sheets.

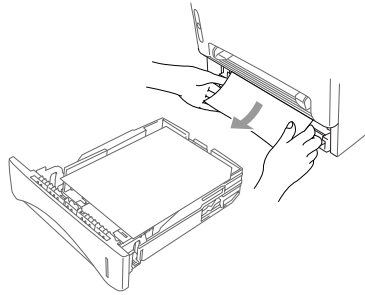

- 3** Adjust the guides to fit.
- 4** Press down the paper to flatten it in the paper cassette.
- 5** Reinstall the paper cassette.

Paper is Jammed near the Drum Unit

- 1** Open the front cover.
- 2** Remove the drum unit but do not force it if it cannot be removed easily. Instead, pull the edge of the jammed paper from the paper cassette.

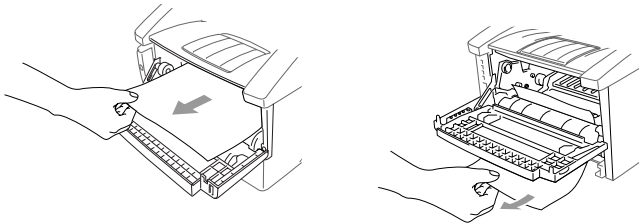

- 3** Gently pull out the jammed paper.
- 4** Reinstall the drum unit.
- 5** Close the front cover.

Paper is Jammed in the Fuser Unit

- 1** Open the rear cover.
- 2** Pull out jammed paper. When you have to pull paper out the back of the machine, the fuser may get dirty with toner powder causing the next few printed page(s) to look messy. Print a few copies of the test page until the pages print clearly.
- 3** Close the rear cover.

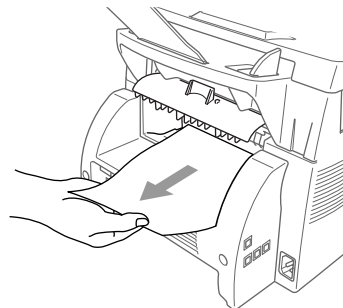

If You Are Having Difficulty with Your Machine

If you think there is a problem with your machine, *make a copy first*. If the copy looks good, the problem is probably not your machine. Check the table below and follow the troubleshooting tips.

DIFFICULTY	SUGGESTIONS
Printing and Receiving Faxes	
<p>Condensed print and horizontal streaks; top and bottom of sentences are cut off.</p>	<p>If your copy looks good, you probably had a bad connection, with static or interference on the phone line. If the copy looks bad, clean the scanner area. If there is still a problem, call Brother Customer Service at: 1-800-284-4329 (in USA) or 1-877-BROTHER (in Canada) or (514) 685-6464 (in Montreal).</p>
<p>Vertical streaks; black lines appear on the faxes you receive.</p>	<p>Sometimes you may see vertical streaks/black lines on the faxes you receive. Either your machine's primary corona wire for printing may be dirty, or the sending party's fax scanner may be dirty. Clean your primary corona wire (see pages 19-19), or ask the sender to make a copy to see if the problem is with the sending machine. Try receiving from another fax machine. If the problem continues, call Brother Customer Service at: 1-800-284-4329 (in USA) or 1-877-BROTHER (in Canada) or (514) 685-6464 (in Montreal).</p>
<p>The FAX "hears" voice as CNG tone.</p>	<p>If your machine is set to Easy Receive ON, it is more sensitive to sounds. Your machine may mistakenly interpret certain voices or music on the line as a calling fax machine and respond with fax receiving tones. Deactivate the fax by pressing #51 if you are at an extension phone or press Stop/Exit if you are at the machine or an external phone. Try avoiding this problem by turning Easy Receive to OFF. (See <i>Easy Receive</i>, Page 5-3)</p>
<p>Horizontal streaks; lines are missing.</p>	<p>You may get a fax with horizontal streaks or with missing lines. Usually this is caused by a poor telephone connection. Ask the other party to send the fax again.</p>
<p>Received faxes appear as split or blank pages.</p>	<p>If the received data is divided and printed on two pages or if you get an additional blank page, your Paper Size setting may not be correct for the paper you are using (see page 4-1). If you are using the fixed reduction feature, check to see if the reduction ratio is suitable for the real paper. (See page 11-3)</p>



DIFFICULTY	SUGGESTIONS
Phone Line or Connections	
Dialing does not work.	Check for a dial tone. Change TONE/PULSE setting (See <i>Setting Tone/Pulse Dialing Mode</i> , Page 4-8). Check all line cord connections, and make sure the curled handset cord is not in the EXT jack. Check power cord connection. Send a manual fax by pressing Hook—OR— by lifting the handset, and dialing the number. Wait to hear the fax receiving tones before pressing Fax Start .
The machine does not answer when called.	Make sure the machine is in the correct receiving mode for your setup (either FAX , FAX/TEL or TAD). Check for dial tone. If possible, call your machine to hear it answer. If there is still no answer, check the telephone line cord connection. Connect a standard telephone handset to the machine telephone jack. If there is no ringing when you call your machine, call your Telephone Company to check the line.
There is no dial tone on the handset.	Press Hook—OR— Lift the handset. If you hear no dial tone, check telephone line cord connections at the machine and wall jack. Check that the handset curled cord is connected to the machine's handset jack. Test the jack with another single line telephone. If no dial tone on the wall outlet, call your telephone company.
Sending Faxes	
Transmitting quality is poor.	Try changing your resolution to FINE or S. FINE (See <i>Fax Resolution</i> , Page 6-5). Make a copy to verify the machine's scanner operation.
Transmission Verification Report prints "Results:NG".	There is probably temporary noise or static on the phone line. Try sending the fax again. If the problem continues, call the Telephone Company to check your phone line.
The receiving party says the picture is not clear.	Sometimes the resolution mode you chose when you sent your fax was not appropriate. Send the fax again, but try using the FINE or S. FINE mode. Also, your machine's scanner may be dirty, so try cleaning it. (See page 19-18)
The receiving party says vertical streaks appear on the faxes they receive.	Your machine's scanner may be dirty or the receiving party's print head may be dirty. Clean your scanner (see page 19-18), and then make a copy to check if the problem was caused by your machine.



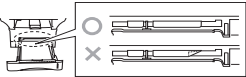

DIFFICULTY	SUGGESTIONS
Handling Incoming Calls	
Double-ring in FAX/TEL mode.	The machine knows the incoming call is not a fax, so it is signaling you to answer the telephone call. Pick up the machine handset or answer from an extension phone and then press your machine's Telephone Answer Code (default setting is #51).
I have difficulty transferring a fax call to the machine.	If you answered at the machine, press Fax Start and hang up immediately. If you answered at an extension phone, press your machine's Remote Activation Code (default setting is *51). When your machine answers, hang up.
I have difficulty with custom features on a single line.	<p>If you have Call Waiting, RingMaster, Voice Mail, an answering machine, alarm system or any other custom feature on a single phone line with your fax machine, it may create a problem sending or receiving fax data.</p> <p>If you are sending or receiving a fax message while a custom feature signal comes through on the line, the signal can temporarily interrupt or disrupt the fax data. Brother's ECM feature should help overcome this problem. This condition is related to the telephone system industry and is common to all devices that send and receive information on a single, shared line with custom features. If avoiding a slight interruption is crucial to your business, a separate line with no custom features is recommended.</p>

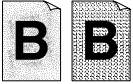

DIFFICULTY	SUGGESTIONS
General Printing Difficulties	
<p>The machine does not print.</p>	<p>Check the following:</p> <ul style="list-style-type: none"> • The machine is plugged in. • The toner cartridge and drum unit are installed properly. • The interface cable is securely connected between the machine and the computer. • Check to see if LCD is showing an error message. (See pages 19-1 to 19-3)
<p>The machine prints unexpectedly or it prints garbage.</p>	<p>Reset the machine. Check the primary settings in your application software to make sure it is set up to work with your machine.</p>
<p>The machine prints the first couple of pages correctly, then some pages have text missing.</p>	<p>Your computer is not recognizing the printer input buffer's full signal. Please make sure to connect the printer cable correctly.</p>
<p>The machine cannot print full pages of a document; An OUT OF MEMORY error message occurs.</p>	<p>Reduce the printer resolution. Reduce the complexity of your document and try again. Reduce the graphic quality or the number of font sizes within your application software.</p>
<p>My headers or footers appear when I view my document on the screen, but do not appear when I print them.</p>	<p>Most laser printers have a restricted area that will not accept print. Usually these are the first two lines and last two lines, leaves 62 printable lines. Adjust the top and bottom margins in your document to allow for this.</p>

DIFFICULTY	SUGGESTIONS
Software Difficulties	
<p>“Unable to write to LPT1” or “LPT1 already in use” error message appears.</p>	<p>1. Make sure the machine is on (plugged into the AC outlet) and that it is connected directly to the computer using an IEEE-1284 bi-directional parallel cable. The cable must not go through another peripheral device (such as a Zip Drive, External CD-ROM Drive, or Switch box).</p>
<p>“MFC is Busy” or “MFC Connect Failure” error message appears.</p>	<p>2. Make sure the machine’s LCD screen is not displaying an error message.</p> <p>3. Make sure no other device drivers, which also communicate through the parallel port, are running automatically when you boot up the computer (such as, drivers for Zip Drives, External CD-ROM Drive, etc...) Suggested areas to check: <i>(Load=, Run= command lines in the win.ini file or the Startup Group)</i></p> <p>4. Check with you computer manufacturer to confirm that the computer’s parallel port settings in the BIOS are set to support a bi-directional machine, i.e. (Parallel Port Mode-ECP).</p>
<p>MFC Connect Failure</p>	<p>If the Brother machine is not connected to your PC and you have loaded the Brother software, the PC will show “MFC Connect Failure” each time you restart Windows®. You can ignore this message or you can turn it off by deselect the AutoLoad PopUp check box in the Brother Control Center chapter. (See <i>How to Turn Off AutoLoad</i>, Page 14-2.)</p>
Windows® Setup Printing Difficulties	
<p>I cannot print from my application software.</p>	<p>Make sure the Windows® printer driver is installed and that you selected it in your application software.</p>
<p>Sometimes I get the error message OUT OF MEMORY when printing certain documents from Windows®.</p>	<p>If you are using the supplied Windows® driver, turn the error recover operation on in the Setup dialog box and try again. Reduce the print resolution or reduce the complexity of your document and try again.</p>

DIFFICULTY	SUGGESTIONS
Paper Handling Difficulties	
<p>The Brother machine does not load paper. The LCD shows CHECK PAPER or PAPER JAM.</p>	<p>Check to see if the CHECK PAPER or PAPER JAM message appears on the LCD. If so, the multi-purpose sheet feeder may be out of paper or not properly installed. If it is empty, load a new stack of paper into the feeder. If there is paper in the paper cassette, make sure it is straight. If the paper is curled, you should straighten it. Sometimes it is helpful to remove the paper, turn the stack over and place it back into the paper cassette. Reduce the amount of paper in the paper cassette, and then try again. Check the manual mode is not selected in the printer driver.</p>
<p>How can I load envelopes?</p>	<p>You can load envelopes from the manual feed slot. Your application software must be set up to print the envelope size you are using. This is usually done in the Page Setup or Document Setup menu of your software. Refer to your application manual.</p>
<p>The machine does not load transparencies.</p> 	<p>The Outer Chute on your machine may be bent. Please straighten the Outer Chute, and then use transparencies again. If the machine still does not load transparencies, call Brother Customer Service to troubleshoot the problem with you.</p>
Paper Handling Difficulties (Cont.)	
<p>What paper can I use?</p>	<p>You can use plain paper, envelopes, transparencies and labels for <i>laser</i> machines. For information on paper you can use, See <i>Acceptable Paper</i>, page 2-6.</p>
<p>How can I clear paper jams?</p>	<p>See <i>Paper Jam</i> on page 19-4 to 19-5.</p>
Scanning Difficulty	
<p>TWAIN Errors appear while scanning.</p>	<p>Make sure the Brother TWAIN Driver is selected as the primary source. For FAX-5750e in PaperPort®, click File Select Source, highlight the Brother TWAIN Driver and click Select.</p>

DIFFICULTY	SUGGESTIONS
Copy Quality Difficulties	
Vertical streaks appear in copies.	Sometimes you may see vertical streaks on your copies. Either the scanner or the primary corona wire for printing is dirty. Clean them both. (See pages 19-18 to 19-20)
Print Quality Difficulties	
Printouts are too dark or too light.	Adjust the print conditions by setting the Print Density setting. It has been factory set to the middle position. (See <i>Setting the Print Density</i> , page 5-4.)
<p>Printed pages contain white stripes.</p>  <p>White Stripes or Faint Images</p>	<p>You may fix this by wiping the scanner windows with a clean soft cloth. (See <i>Cleaning the Document Scanner</i>, page 19-18 and <i>Replacing the Drum Unit</i>, page 19-23.) If you still see white stripes or faint images and the LCD shows CHANGE DRUM SOON, replace the drum unit with a new one. Check the machine's environment. Conditions such as humidity and high temperatures may cause this print defect to occur.</p>
<p>Printed pages are stained with toner or have vertical stripes.</p>  <p>Dark Stripes or Toner Stains</p>	<p>Clean the machine's interior and the primary corona wire of the toner cartridge. (See <i>Routine Maintenance</i>, page 19-18 and <i>Cleaning the Drum Unit</i>, page 19-19.) Make sure that the tab of the corona wire is at the home position. If after cleaning, you still see dark stripes or toner stains and the LCD shows CHANGE DRUM SOON, replace the drum unit with a new one.</p>
<p>Printed pages have white in black text and graphic areas.</p>  <p>White Spots</p>	<p>Make sure that you use paper that meets the specifications. Rough surface or thick media can cause the problem. If you still see white spots and the LCD shows CHANGE DRUM SOON, replace the drum unit with a new one. Check the machine's environment; conditions such as high humidity may cause this situation to occur.</p>

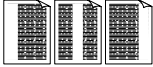
DIFFICULTY	SUGGESTIONS
Print Quality Difficulties (CONTINUED)	
<p>Toner scatters and stains the printed page.</p>  <p>Scattering Toner</p>	<p>Adjust the print conditions by setting the Print Density setting. Remove the drum unit and clean the machine's interior. (See <i>Routine Maintenance</i>, page 19-18, <i>Cleaning the Printer</i>, page 19-18 and <i>Cleaning the Drum Unit</i>, page 19-19.) Make sure that you use paper that meets specifications. (See pages 2-6.) If you still have scattered toner and the LCD shows CHANGE DRUM SOON, replace the drum unit with a new one.</p> <p>Check the machine's environment. Conditions such as humidity and high temperatures may cause this print defect to occur.</p>
<p>The whole page is printed black.</p>  <p>Black Page</p>	<p>Wipe the electric terminals referring to page 19-18. Also, do not use heat-sensitive paper because it will cause this problem. After cleaning, if the printed pages are still black and the LCD shows CHANGE DRUM SOON, replace the drum unit with a new one.</p>
<p>Nothing is printed on the page.</p>  <p>White page</p>	<p>Make sure that the toner cartridge is not empty. Wipe the electric terminals. (See <i>Routine Maintenance</i>, page 19-18, <i>Cleaning the Printer</i>, page 19-18 and <i>Cleaning the Drum Unit</i>, page 19-19.) Make sure that a torn piece of paper does not remain on the scanner window.</p>
<p>Printed pages are marked at regular intervals.</p>  <p>Example of Regular Marks</p>	<p>Marks may disappear by themselves. Try copying multiple pages to clear this problem. Marks may occur if the machine has not been used for a long time. A possible cause is that the surface of the drum is scratched. You must then replace the drum unit with a new one. If the marks do not disappear, it may be that the drum was marked or damaged by excessive exposure to light. In this case, replace the drum unit with a new one.</p>

DIFFICULTY	SUGGESTIONS
Print Quality Difficulties (CONTINUED)	
<p>Printed pages are blurred at the center or at either edge.</p>  <p style="text-align: center;">Blurred Page</p>	<p>Certain environmental conditions such as humidity and high temperatures may cause this condition to occur. Make sure the machine is placed on a flat, horizontal surface. Remove the drum unit with the toner cartridge installed. Try rocking them from side to side. You may clear a blurred page by wiping the scanner windows with a clean soft cloth. (See <i>Routine Maintenance</i>, page 19-18, <i>Cleaning the Printer</i>, page 19-18 and <i>Cleaning the Drum Unit</i>, page 19-19.) If a blurred page occurs after cleaning and the LCD shows CHANGE DRUM SOON, replace the drum unit with a new one.</p>
<p>Ghost images appear on the printed page.</p>  <p style="text-align: center;">Ghost Images</p>	<p>Adjust the print conditions by setting the Print Density setting, page 5-4. Make sure you use paper that meets the specifications. Rough surfaces or thick media can cause a ghost image.</p>



The drum unit is a consumable item and it is necessary to replace it periodically.

Packing and Shipping the Machine

Whenever you transport the machine, use the packing materials that came with your machine. Also, follow the steps below to pack the machine so it won't be damaged, which would void the machine's warranty.

- 1 Remove the telephone line cord and unplug the machine from the AC outlet.
- 2 Open the front cover.
- 3 Remove the drum unit.

! Caution

Remove the drum unit and toner cartridge assembly. Leave the toner cartridge installed in the drum unit.

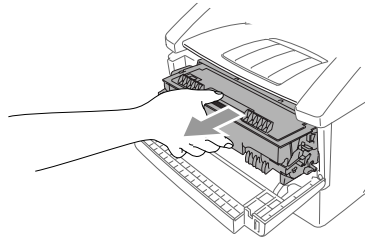

- 4 Place the drum unit and toner cartridge assembly into the plastic bag and seal the bag.

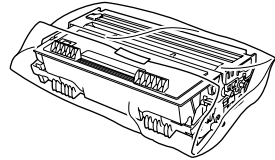

- 5 Close the front cover. Fold down the front output bin extension. Remove the telephone line cord, document tray, document support, handset, and handset cord, and pack them.

- 6 If Cassette #2 is connected, unplug the modular cable from the modular jack of the Brother machine.

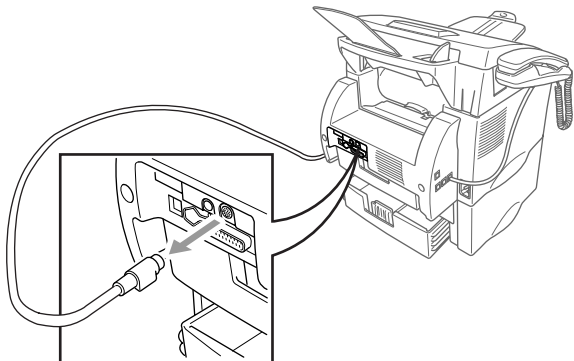

- 7 If you have the Cassette #2 option, carefully pick up the machine and remove Cassette #2 to pack it *separately*.

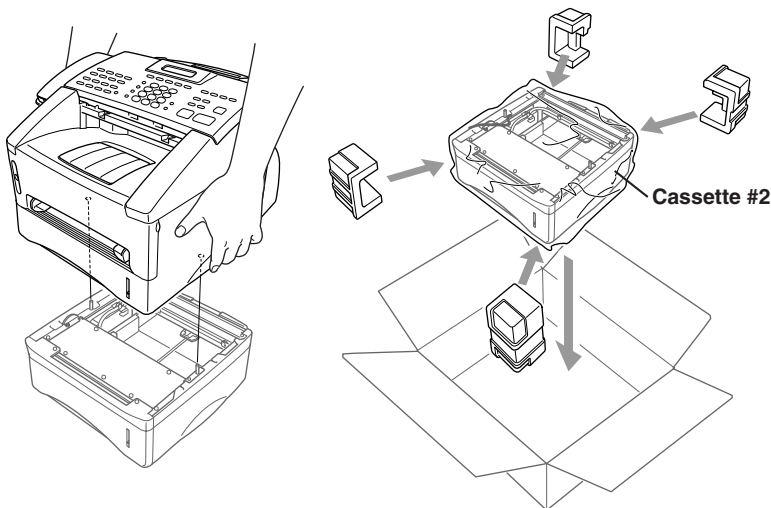

- 8 Pack additional parts (cord, paper cassette, printed materials) in the carton.

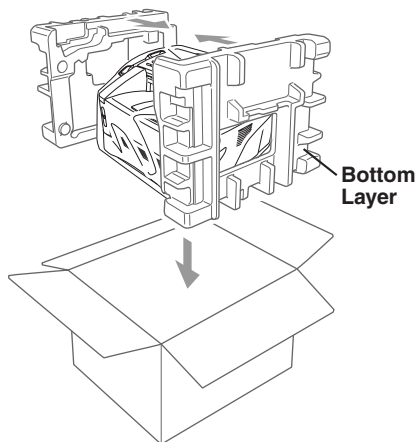

Note If you are returning the machine to Brother as part of the Exchange Service, pack only the machine. Keep all separate parts to use with your “Exchange” machine.

! Caution

Be sure to take out any optional memory upgrade boards or network cards before packing the machine.

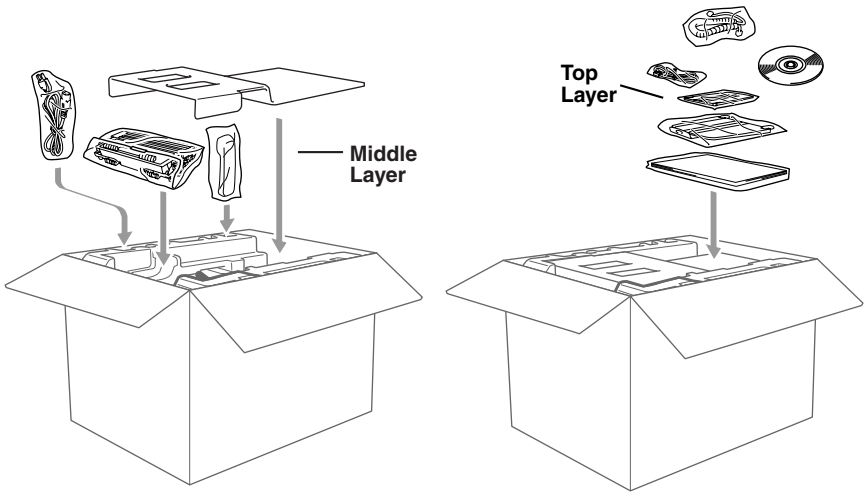

9 Close the carton and tape it shut.

Routine Maintenance

Keep your machine in optimum condition by cleaning it on a regular basis. It is a good idea to clean the drum unit during this routine. Avoid using thinners or other organic solvents and do not use water.

Cleaning the Document Scanner

- 1 Unplug the telephone line, and then the power cord.
When you reconnect these lines later, connect the power cord *first*, and then the telephone line.
- 2 Lift the control panel cover.
- 3 Clean the white bar and glass cover under the white bar.
Moisten a small, clean, soft, lint-free cloth with isopropyl alcohol and carefully remove dirt from the glass cover and the white bar.

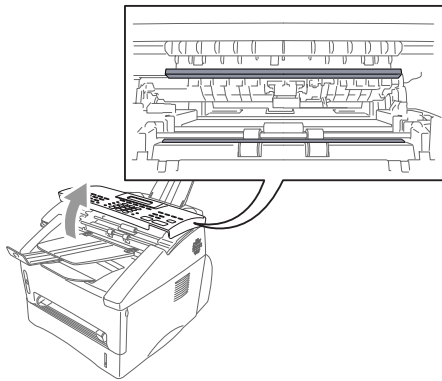

Cleaning the Printer

! Caution

- Do *not* use isopropyl alcohol to remove dirt from the control panel. It may crack the panel.
- Do *not* use isopropyl alcohol to clean the scanner window.
- Do *not* touch the scanner window with your finger.
- The drum unit contains toner, so handle it carefully. If toner scatters and your hands or clothes get dirty, immediately wipe or wash it off with cold water.

- 1 Open the front cover.
- 2 Remove the drum unit assembly.

! WARNING

Just after you have used the machine, some internal parts of the machine are extremely **HOT!** When you open the front cover of the machine, never touch the shaded parts as shown in the diagram below.

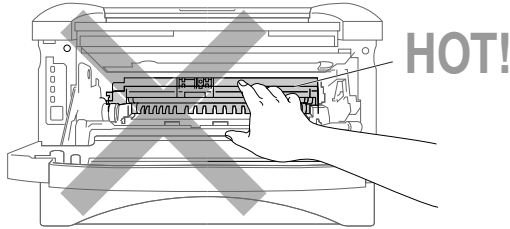

- 3** Gently clean the scanner window by wiping with a clean soft dry cloth. *Do not* use isopropyl alcohol.

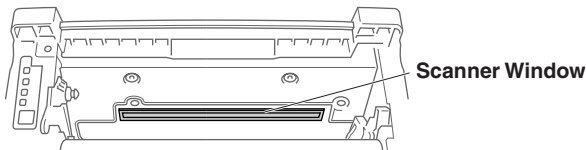

Cleaning the Drum Unit

We recommend placing the drum unit on a drop cloth or large disposable paper to avoid spilling and scattering toner.

- 1** Clean the primary corona wire inside the drum unit by gently sliding the tab from right to left several times.
- 2** Return the tab and snap it into the Home position (▼).

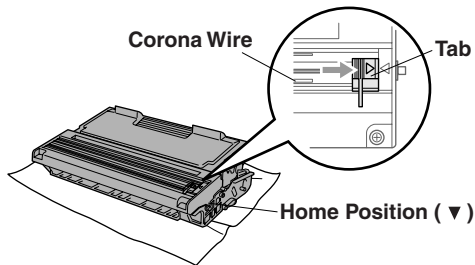

! Caution

If the tab is not at the Home position, printed pages may have vertical stripes.

- 3 Reinstall the drum unit into the machine.
(See *Replacing the Drum Unit*, Page 19-23.)
- 4 Close the front cover.
- 5 Plug in the power cord *first*, and then plug in the telephone cord.

Replacing the Toner Cartridge

The machine can print up to 6,000 pages using a *high yield* toner cartridge. When the toner cartridge is running low, the display shows **TONER LOW**. The machine is supplied with a *standard* toner cartridge that must be replaced after approximately 3,000 pages. Actual page count will vary depending on your average document type (i.e., standard letter, detailed graphics).

It is a good idea to keep a new toner cartridge ready for use when you see the toner low warning.

Discard the used toner cartridge according to local regulations, keeping it separate from domestic waste. Be sure to seal the toner cartridge tightly so toner powder does not spill out of the cartridge. If you have questions, call your local waste disposal office.

We recommend that you clean the machine when you replace the toner cartridge.

Toner Empty Indicator

When the toner cartridge is running low, the LCD shows **TONER LOW** and the Toner Empty icon on the control panel flashes on and off to indicate the toner is low.

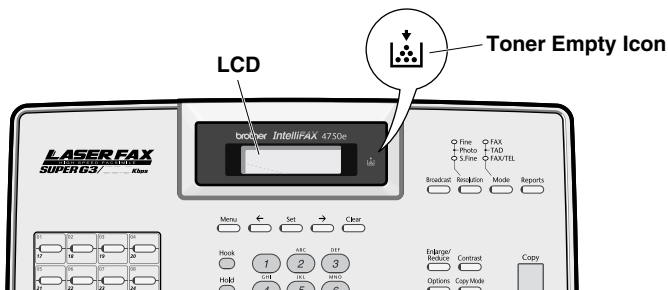

The Toner Empty icon appears and the LCD shows **TONER EMPTY**. Once this icon appears, your machine will not resume printing until you install a new toner cartridge.

⚠ WARNING

Just after you use the machine, some internal parts of the machine will be extremely **HOT!** So, never touch the shaded parts shown in the illustration.

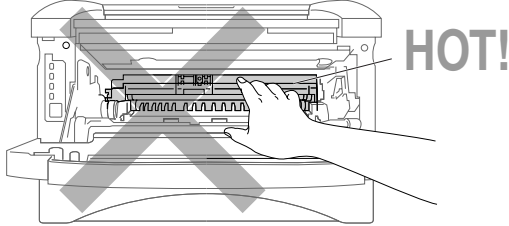

- 1 Open the front cover and pull out the drum unit.

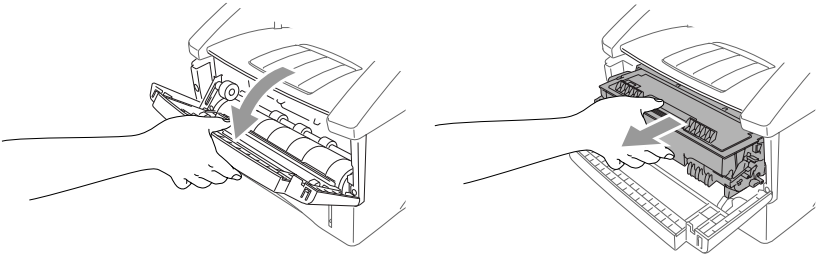

Place the drum unit on a drop cloth or large piece of disposable paper to avoid spilling and scattering the toner.

- 2 Hold down the lock lever on the right as you pull the toner cartridge out of the drum unit.

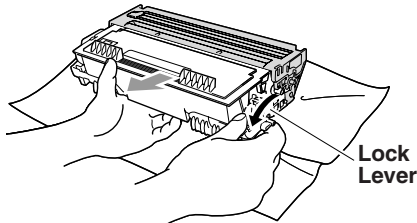

⚠ Caution

Handle the toner cartridge carefully. If toner scatters on your hands or clothes, immediately wipe it off or wash it with cold water.

- 3 Unpack the new toner cartridge. Place the used toner cartridge into the aluminum bag and discard it according to local regulations.

! Caution

- Wait to unpack the toner cartridge until immediately before you install it into the machine. If a toner cartridge is left unpacked for a long period of time, the toner life is shortened.
- You can use only a genuine Brother Toner Cartridge (**TN-430 or TN-460**), which is specially formulated to ensure top print quality. Using another brand of toner cartridge may void your machine's warranty. Warranty coverage does not apply to problems caused by the use of 3rd party Toner, 3rd party Toner cartridge or 3rd party Drum unit.

- 4** Gently rock the toner cartridge from side to side five or six times to distribute the toner evenly inside the cartridge.

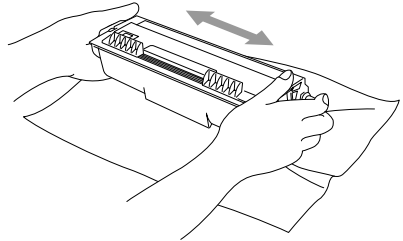

- 5** Remove the protective cover.

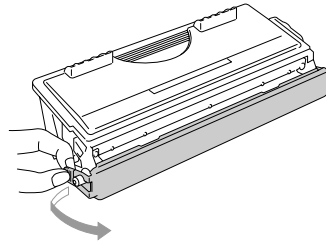

- 6** Install the new toner cartridge into the drum unit until it clicks into place.

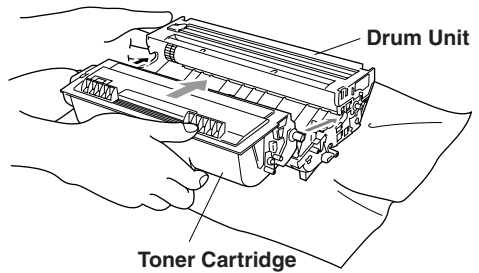

- 7** Clean the primary corona wire inside the drum unit by gently sliding the blue tab from right to left several times. Return the blue tab to the Home position before reinstalling the drum unit assembly.

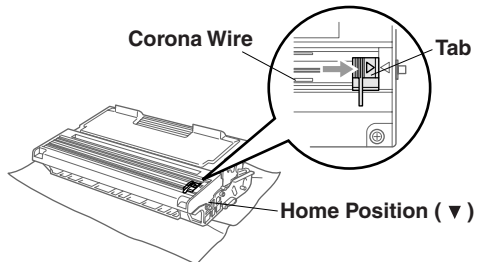

- 8 Reinstall the drum unit and close the front cover.

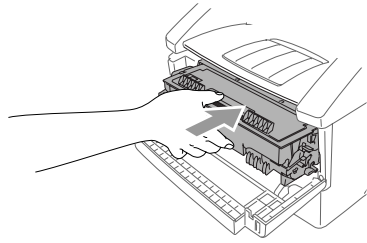

Replacing the Drum Unit

The machine uses a drum unit to create print images on paper. If the LCD shows **CHANGE DRUM SOON**, the drum unit is near the end of its life and it is time to purchase a new one.

Even if the LCD shows **CHANGE DRUM SOON**, you may be able to continue printing without having to replace the drum unit for a while. However, if there is a noticeable deterioration in the output print quality (even before **CHANGE DRUM SOON** is shown), then the drum unit should be replaced. You should clean the machine when you replace the drum unit. (See Page 19-19.)

! Caution

When removing the drum unit, handle it carefully because it contains toner. If toner scatters and your hands or clothes get dirty, immediately wipe or wash with cold water.

 The drum unit is a consumable item, and it is necessary to replace it periodically. There are many factors that determine the actual drum life, such as temperature, humidity, type of paper and how much toner you use for the number of pages per print job. The estimated drum life is *up to* 20,000 pages. The actual number of pages your drum will print may be significantly less than these estimates. Because we have no control over the many factors that determine the actual drum life, we cannot guarantee a minimum number of pages that will be printed by your drum.

! WARNING

Just after you have used the machine, some internal parts of the machine are extremely **HOT!** So please be careful.

Follow these steps to replace the drum unit:

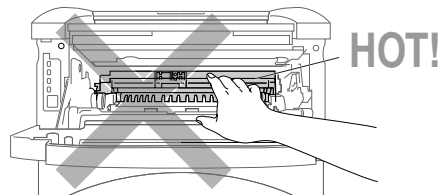

- 1 Open the front cover.
- 2 Remove the old drum unit.
Place the drum unit on a drop cloth or disposable paper to avoid scattering toner.

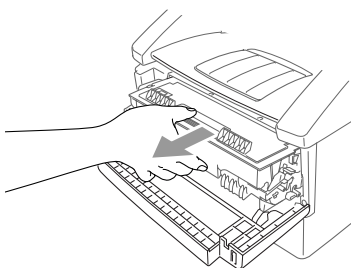

- 3 Hold down the lock lever on the right and pull the toner cartridge out of the drum unit assembly.
(See *Replacing the Toner Cartridge*, Page 19-20.)

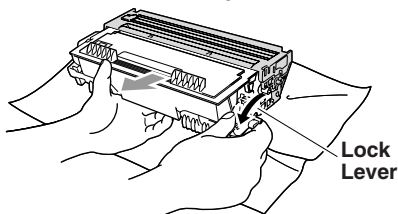

-  Discard the used drum unit according to local regulations, keeping it separate from domestic waste. Be sure to seal the drum unit tightly so toner powder does not spill out of the unit. If you have questions, call your local waste disposal office.

 - 4 Wait to unpack the new drum unit until immediately before installing it. Place the old drum unit into the aluminium bag, and then discard it according to local regulations.
 - 5 Reinstall the toner cartridge into the new drum unit. (See *Replacing the Toner Cartridge*, Page 19-20.)
 - 6 Reinstall the new drum unit, keeping the front cover *open*.
 - 7 Press **Clear**.
 - 8 Press **1** and when the LCD shows ACCEPTED, and then close the front cover.

REPLACE DRUM?
 1.YES 2.NO

Caution

If toner scatters and your hands or clothes get dirty, immediately wipe off or wash with cold water.

Checking the Drum Life

You can see the percentage of the drum's life that remains available.

- 1 Press **Menu, 2, 0, 3**.
- 2 For five seconds, the LCD shows the available percentage of drum life.

3.DRUM LIFE

DRUM LIFE
 REMAINING: 70%

-  Even if the remaining drum life is 0%, you may continue to use the drum unit until you have a print quality problem.

20 Important Information

Standard Telephone and FCC Notices

These notices are in effect on models sold and used in the United States only.

This equipment is hearing aid compatible.

When programming emergency numbers and making test calls to emergency numbers:

- Remain on the line and briefly explain to the dispatcher the reason for the call before hanging up.
- Perform these activities in the off-peak hours, such as early morning or late evening.

This equipment complies with Part 68 of FCC Rules. On the rear panel of this equipment is a label that contains, among other information, the FCC Registration Number and Ringer Equivalence Number (REN) for this equipment. You must, upon request, provide this information to your telephone company.

You may safely connect this equipment to the telephone line by means of a standard modular jack, USOC RJ11C.

An FCC compliant telephone cord with a modular plug is provided with this equipment. This equipment is designed to be connected to the telephone line or premises wiring using a compatible modular jack that is Part 68 compliant. See the Installation section of this manual for details.

The REN is useful to determine the quantity of devices you may connect to your telephone line and still have those devices ring when your telephone number is called. In most, but not all areas, the sum of the RENs of all devices connected to one line should not exceed five (5). To be certain of the number of devices you may connect to your line, as determined by the REN, you should contact your local telephone company to determine the maximum REN for your calling area. If your FAX-4750e or FAX-5750e damages the telephone line, the telephone company may discontinue your service temporarily. If possible, they will notify you in advance. But if advanced notice is not practical, you will be notified as soon as possible. You will be informed of your right to file a complaint with the FCC.

Your telephone company may make changes to its facilities, equipment, operations or procedures that could affect the proper functioning of your equipment. If they do, you will be notified in advance to give you an opportunity to maintain uninterrupted telephone service.

If you experience trouble with your FAX-4750e or FAX-5750e, please contact a Brother Authorized Service Center for information on obtaining service or repair. The telephone company may ask that you disconnect this equipment from the line until the problem has been corrected or until you are sure that the equipment is not malfunctioning.

If you are not able to solve a problem with your machine, contact Brother Customer Service. (See *Brother Numbers*, page i)

WARNING

For protection against the risk of electrical shock, always disconnect all cables from the wall outlet before servicing, modifying or installing the equipment.

This equipment may not be used on coin service lines provided by the telephone company or connected to party lines.

Brother cannot accept any financial or other responsibilities that may be the result of your use of this information, including direct, special or consequential damages. There are no warranties extended or granted by this document.

Laser Safety

This equipment is certified as a Class I laser product under the U.S. Department of Health and Human Services (DHHS) Radiation Performance Standard according to the Radiation Control for Health and Safety Act of 1968. This means that the equipment does not produce hazardous laser radiation.

Since radiation emitted inside the equipment is completely confined within protective housings and external covers, the laser beam cannot escape from the fax machine during any phase of user operation.

FDA Regulations

U.S. Food and Drug Administration (FDA) has implemented regulations for laser products manufactured on and after August 2, 1976. Compliance is mandatory for products marketed in the United States. One of the following labels on the back of the machine indicates compliance with the FDA regulations and must be attached to laser products marketed in the United States.

Manufactured

BROTHER CORP. (ASIA) LTD.

BROTHER BUJI NAN LING FACTORY

Gold Garden Industry, Nan Ling Village, Buji, Rong Gang, Shenzhen, China.

This product complies with FDA radiation performance standards,
21 CFR Subchapter J.



WARNING

Use of controls, adjustments or performance of procedures other than those specified in this manual may result in hazardous invisible radiation exposure.



Caution

Changes or modifications not expressly approved by Brother Industries, Ltd. may void the user's authority to operate the equipment.

Internal laser radiation

Max. Radiation Power	5 mW
Wave Length	760 - 810 nm
Laser Class	Class IIIb (Accordance with 21 CFR Part 1040.10)

Federal Communications Commission (FCC) Declaration of Conformity (For USA Only)

Responsible Party:	Brother International Corporation 100 Somerset Corporate Boulevard Bridgewater, NJ 08807-0911 USA TEL: (908) 704-1700
--------------------	--

declares, that the products

Product Name: FAX-4750e
FAX-5750e

comply with Part 15 of the FCC Rules. Operation is subject to the following two conditions: (1) This device may not cause harmful interference, and (2) this device must accept any interference received, including interference that may cause undesired operation.

This equipment has been tested and found to comply with the limits for a Class B digital device, pursuant to Part 15 of the FCC Rules. These limits are designed to provide reasonable protection against harmful interference in a residential installation. This equipment generates, uses, and can radiate radio frequency energy and, if not installed and used in accordance with the instructions, may cause harmful interference to radio communications. However, there is no guarantee that interference will not occur in a particular installation. If this equipment does cause harmful interference to radio or television reception, which can be determined by turning the equipment off and on, the user is encouraged to try to correct the interference by one or more of the following measures:

- Reorient or relocate the receiving antenna.
- Increase the separation between the equipment and receiver.
 - Connect the equipment into an outlet on a circuit different from that to which the receiver is connected.
 - Ask the dealer or an experienced radio/TV technician for help.

Important

Changes or modifications not expressly approved by Brother Industries, Ltd. could void the user's authority to operate the equipment.

Industry Canada Compliance Statement (For Canada Only)

This Class B digital apparatus complies with Canadian ICES-003.

Cet appareil numérique de la classe B est conforme à la norme NMB-003 du Canada.

Warranty

You use the IEEE-1284 shielded parallel cable provided by Brother Industries, Ltd. (See *Ordering Accessories and Supplies*, page ii.)

Important Safety Instructions

- 1** Read all of these instructions.
- 2** Save them for later reference.
- 3** Follow all warnings and instructions marked on the product.
- 4** Unplug this product from the wall outlet before cleaning. Do not use liquid or aerosol cleaners. Use a damp cloth for cleaning.
- 5** Do not place this product on an unstable cart, stand, or table. The product may fall, causing serious damage to the product.
- 6** Slots and openings in the cabinet and the back or bottom are provided for ventilation. To ensure reliable operation of the product and to protect it from overheating, these openings must not be blocked or covered. The openings should never be blocked by placing the product on a bed, sofa, rug, or other similar surface. This product should never be placed near or over a radiator or heater. This product should never be placed in a built-in installation unless proper ventilation is provided.
- 7** This product should be operated from the type of power source indicated on the label. If you are not sure of the type of power available, ask your dealer or local power company.

- 8** This product is equipped with a 3-wire grounding type plug, a plug having a third (grounding) pin. This plug will fit into only a grounding-type power outlet. This is a safety feature. If you are unable to insert the plug into the outlet, contact your electrician to replace your obsolete outlet. Do not defeat the purpose of the grounding-type plug by using an adapter.
- 9** Do not allow anything to rest on the power cord. Do not place this product where people can walk on the cord.
- 10** If an extension cord is used with this product, make sure that the total ampere ratings on the products plugged into the extension cord do not exceed the extension cord ampere rating. Also, make sure that the total of all products plugged into the wall outlet does not exceed 15 amperes (USA only).
- 11** Never push objects of any kind into this product through cabinet slots, since they may touch dangerous voltage points or short out parts resulting in the risk of fire or electric shock. Never spill liquid of any kind on the product.
- 12** This product does not have an ON/OFF switch. Therefore, it is very important that you have easy access to the main plug and the main socket to which the plug is connected, in case the main power to the Brother machine must be disconnected quickly.
- 13** Unplug this product from the wall outlet and refer servicing to Authorized Service Personnel under the following conditions:
 - A When the power cord is damaged or frayed.
 - B If liquid has been spilled into the product.
 - C If the product has been exposed to rain or water.
 - D If the product does not operate normally when the operating instructions are followed. Adjust only those controls that are covered by the operating instructions. Improper adjustment of other controls may result in damage and will often require extensive work by a qualified technician to restore the product to normal operation.
 - E If the product has been dropped or the cabinet has been damaged.
 - F If the product exhibits a distinct change in performance, indicating a need for service.
- 14** Do not attempt to service this product yourself, as opening or removing covers may expose you to dangerous voltage points and/or other risks, and may void your warranty. Refer all servicing to Authorized Service Personnel. A list of Authorized Service Centers has been included for your convenience, or you may contact Customer Service for your nearest Brother Authorized Service Center. (See *Brother Numbers*, page i.)
- 15** To protect your product against power surges, we recommend the use of a power protection device (Surge Protector).

16 When using your telephone equipment, basic safety precautions should always be followed to reduce the risk of fire, electric shock and injury to persons, including the following:

- Do not use this product near water (for example, near a bathtub, sink, swimming pool or in a wet basement).
- Do not use the machine's telephone during an electrical storm (there is the remote possibility of an electrical shock) or to report a gas leak in the vicinity of the leak.
- Use only the power cord indicated in this manual.

Trademarks

Brother is a registered trademark of Brother Industries, Ltd.

The Brother logo is a registered trademark of Brother Industries, Ltd.

Multi-Function Link is a registered trademark of Brother Industries, Ltd.

© Copyright 1996–2002 Brother Industries, Ltd. All rights reserved.

TextBridge and PaperPort are registered trademarks of ScanSoft, Inc.

Windows and Windows NT, Microsoft, MS-DOS, Excel and Word are registered trademarks of Microsoft in the U.S. and other countries.

NT is a trademark of Northern Telecom Limited.

Macintosh and Quick Draw are registered trademarks and iMac, iBook and TrueType are trademarks of Apple Computer, Inc.

Centronics is a trademark of Genicom Corporation.

Epson is a registered trademark and FX-80 and FX-850 are trademarks of Seiko Epson Corporation.

Hewlett Packard is a registered trademark and HP LaserJet II, IIP, and IID are trademarks of Hewlett-Packard Company.

IBM, IBM PC, and Proprinter are registered trademarks of International Business Machines Corporation.

Hammermill copyplus white is a registered trademark of International Paper.

All other terms and brand and product names mentioned in this manual are registered trademarks of their respective companies.

Glossary

- ADF (Automatic Document Feeder)** Originals can be placed in the ADF and scanned one at a time automatically.
- Auto Dial List** A listing of names and numbers stored in One Touch and Speed Dial memory, in numerical order.
- automatic fax transmission Hook.** Sending a fax without picking up the handset or pressing Hook.
- Automatic Redial** If the fax did not go through because the line was busy, the Brother machine redials the number.
- Auto Reduction** Reduces the size of incoming faxes.
- Backup Print** Sets your Brother machine to print a copy of faxes that are received and stored in memory.
- Batch Transmission** As a cost savings feature, all delayed faxes to the same fax number will be sent as one transmission.
- Beeper** The sound the keys make when they are pressed, an error occurs or a document has been received or transmitted.
- Beeper Volume** Volume setting for the beep when you press a key or make an error.
- Broadcasting** The ability to send the same fax message to more than one location.
- Brother Control Center (Not Available for FAX-4750e)** A window that enables you to click on a button to choose the type of scanning operation you want to perform. If you set up the Control Center window to load each time you boot your PC, this window will appear each time you place a original in the ADF.
- Caller ID** A service purchased from the Telephone Company that lets you see the number (or name) of the party calling you. Your Brother machine stores the latest callers so you can print a Log, view caller information, register selected callers as auto dial numbers.
- Cancel Job** Cancels a programmed job, like Delayed Fax or Polling.
- CNG tones** The special tones (beeps) sent by fax machines during automatic transmission to tell the receiving machine that a fax machine is calling.
- communication error (or Comm. Error)** An error during fax sending or receiving, usually caused by line noise or static.
- coding method** Method of coding the information contained in an original. All fax machines must use a minimum standard of Modified Huffman (MH). Your Brother machine is capable of greater compression methods: Modified Read (MR) Modified Modified Read (MMR) and Joint Bi-level Image export working Group (JBIG) if the receiving machine has the same capability.
- compatibility group** The ability of one fax unit to communicate with another. Compatibility is assured between ITU-T Groups.
- Contrast** A setting that compensates for dark or light originals, by lightening dark documents or darkening light originals.

Cover Page Prints a page at the other party's machine that contains the sender and recipient's name and fax number, number of pages and comment. You can generate an electronic cover page at the other end with pre-programmed information from memory or you can print a sample cover page to fax with your original.

Cover Page Message The comment that is on the Cover Page. This is a programmable feature.

Delayed Fax Sends your fax at a later time that day.

Delayed Timer You can program a certain time each day that all delayed faxes will be sent on a first come/first served basis.

Distinctive Ring A service purchased from your telephone company that provides another phone number on an existing phone line. The Brother machine uses the new number to simulate a dedicated fax line.

drum unit A printing device for your machine.

Dual Access Your Brother machine can scan outgoing faxes or scheduled jobs into memory at the same time it is sending a fax or receiving or printing an incoming fax.

Easy Receive Enables your Brother machine to respond to CNG tones if you interrupt a fax call by answering it.

ECM (Error Correction Mode) Detects errors during fax transmission and automatically resends the page(s) that had an error.

extension phone A telephone on the fax number that is plugged into a separate wall jack.

external phone A TAD (telephone answering device) or telephone that is plugged into the EXT jack of your Brother machine.

F/T Ring Time The length of time the Brother machine rings (when the receive mode setting is FAX/TEL) to notify you to pick up a voice call that it answered.

Fax Activity Report Lists information about the last 200 incoming and outgoing faxes. TX means Transmit. RX means Receive.

Fax Forwarding Sends a fax received in memory to another preprogrammed fax number.

Fax Receive Code Press this code (*51) when you answer a fax call from an extension or external phone.

Fax Storage You can print stored faxes later, or retrieve them from another location using Fax Forwarding, Paging, or Remote Retrieval commands.

FAX/TEL You can receive faxes and telephone calls. Do not use this mode if you are using a telephone answering device (TAD).

fax tones The signals sent by sending and receiving fax machines while communicating information.

Fine Mode Resolution is 203 × 196 dpi. It is used for small print and graphs.

gray scale The shades of gray available for copying and faxing photographs.

Group number A combination of One Touch and Speed Dial numbers that are stored on a One Touch key for Broadcasting.

Help List By pressing the **Reports** key and **1**, you can get a printout of the complete Menu so you can use it to program your Brother machine when you do not have the Owner's Manual with you.

- Interval** The preprogrammed time period between automatically printed Fax Activity Reports. You can print Activity Reports on demand without interrupting this cycle.
- LCD (liquid crystal display)** The LCD screen on the Brother machine that shows interactive messages during On-Screen Programming and defaults to the date and time when the machine is idle.
- manual fax** When you press **Hook—OR—**lift the handset so you can hear the receiving fax machine answer before you press **Fax Start** to begin transmission.
- Menu mode** Programming mode for changing the settings of your Brother machine.
- Multi-Function Link® Pro Suite software (Not available for FAX-4750e)** Turns your Brother machine into a printer and a scanner and enables PC faxing using the Brother machine.
- One Touch** Keys on the Brother machine's control panel where you can store numbers for easy dialing. You must use a separate key for each number.
- Out of Paper Reception** Receives faxes into the machine's memory when the machine is out of paper.
- Overseas mode** Makes temporary changes to the fax tones to accommodate noise and static on overseas phone lines.
- Paging** Feature enables your fax unit to call your pager when a fax message is received into its memory.
- Pause** Allows you to place a 3.5 second delay in the dialing sequence stored on One Touch and Speed Dial numbers.
- Photo mode** A resolution setting that uses varying shades of gray for the best representation of photographs.
- Polling** The process of a fax machine calling another fax machine to retrieve waiting fax messages.
- Pulse** A form of dialing on a telephone line.
- Real Time Transmission** When memory is full, send documents in real time.
- Remaining Jobs** You can check which jobs are waiting in memory and cancel jobs individually.
- Remote Activation** Allows you to transfer a fax call, answered at an external or extension phone, to the Brother machine.
- Remote Retrieval Access** The ability to access your Brother machine remotely from a touch tone phone.
- Remote Retrieval Access Code** The four-digit code (159✳) that allows you to call your Brother machine to retrieve fax messages or change fax storage settings.
- Resolution** The number of vertical and horizontal lines per inch. See: Standard, Super Fine and Photo.
- Ring Delay** The number of rings before the Brother machine answers in FAX mode.
- Ring Volume** Volume setting for the Brother machine's ring.
- scanning** The process of sending an electronic image of an original paper document into your computer.

- ScanSoft® PaperPort® for Brother (Not available for FAX-4750e)** Document management application where you can view received faxes and scanned originals.
- ScanSoft® TextBridge® OCR (Not available for FAX-4750e)** Optional Character Recognition (OCR) software that converts a scanned image of text into text you can edit in your word processing application.
- Search** You can scroll through an alphabetical listing on the LCD of the One Touch and Speed Dial numbers you stored.
- Speaker Volume** You can set the volume when your Brother machine is on **Hook**.
- Speed Dial** A preprogrammed number for easy dialing. You must press the Speed Dial button and then a three-digit code to start the dialing process.
- Standard resolution** 203 × 98 dpi. It is used for regular size text and quickest transmission.
- Station ID** The stored information that appears on the top of faxed pages. It includes the sender's name and fax number.
- Super Fine resolution** 203 × 392 dpi. Best for very small print and line art.
- TAD (telephone answering device)** You can connect an external TAD to the EXT. jack for EXT. TEL/TAD mode.
- Telephone Answer Code (FAX/TEL mode only)** When the Brother machine answers a voice call, it double-rings. You can pick up at an extension or external phone by pressing this code (#51).
- temporary settings** You can select certain options for each fax transmission or copy you make without changing the default settings.
- Tone** A form of dialing on the telephone line used for Touch Tone telephones.
- toner cartridge** Accessory that holds toner for the drum unit on Brother laser models.
- Toner Save** A process of affixing less toner to the page to extend the life of the toner cartridge. This will make the print on received documents significantly lighter.
- transmission** The process of sending documents over the phone lines from your Brother machine to the receiving fax machine.
- Transmission Verification Report** A listing of each transmission, showing caller ID, date, time, and number of pages.
- True Type fonts** The fonts that are used in the Windows® operating systems. If you install the Brother True Type fonts, more types of fonts will be available for Windows® applications.
- User Settings List** Printed report of your Brother machine's settings.

S Specifications

Product Description

The FAX-4750e is plain paper fax models.

The FAX-5750e is a plain paper fax model with PC interface.

General

Memory Capacity 8MB

Paper

Paper Specifications for the Cassette

	Cut Sheet
Basis Weight:	16 to 28 lb. (60 to 105 g/m ²)
Caliper:	0.003 to 0.005 inches. (0.08 to 0.13 mm)
Moisture Content:	4% to 6% by weight

Manual Feed Slot

	Cut Sheet	Envelopes
Basis Weight:	16 to 43 lb. (60 to 161 g/m ²)	20 to 24 lb. (75 to 90 g/m ²)
Caliper:	0.003 to 0.008 inches. (0.08 to 0.2 mm)	0.003 to 0.005 inches. (0.084 to 0.14 mm)
Moisture Content:	4% to 6% by weight	4% to 6% by weight

Copy

Copy Speed up to 15 pages/minute (letter or A4 size paper)

Multiple Copies Stacks up to 99 pages
Sorts copies

Enlarge/Reduce 50% to 200% (in increments of 1%)

Resolution 600 dpi class

Fax

Compatibility	ITU-T Group 3
Coding System	MH/MR/MMR/JBIG
Modem Speed	33600/31200/28800/26400/24000/19200/16800/14400/ 12000/9600/7200/4800/2400 Automatic Fallback:
Document Input Width	5.8 inches to 8.5 inches (148 mm to 216 mm)
Document Input Length	3.9 inches to 14.1 inches (100 mm to 360 mm)
Printing Width	8.2 inches (208 mm)
Scanning Width	8.15 inches (207 mm)
Automatic Document Feeder (ADF)	Up to 30 pages* With Conditions: Up to 50 pages*
Paper Cassette	250 sheets (20 lb)
Gray Scale	64 levels
Polling Types	Standard or Sequential
Contrast Control	Automatic/Super Light/Super Dark (Manual setting using control panel keys)
Resolution	<ul style="list-style-type: none">• Horizontal 203 dot/inch (8 dot/mm)• Vertical Standard—98 line/inch (3.85 line/mm) Fine, Photo—196 line/inch (7.7 line/mm) Superfine, Photo—392 line/inch (15.4 line/mm)
LCD (Liquid Crystal Display)	16 characters × 2 Lines
One Touch dial	32 stations
Speed Dial	200 stations
Broadcasting	Up to 282 locations; Up to 6 Groups
Memory Transmission	Up to 500 pages***
Automatic Redial	3 times at 5 minute intervals
Out of Paper Reception	Up to 600 pages***
Speaker Type	Monitor
Auto Answer	0, 1, 2, 3 or 4 rings

* Using standard 17 lb to 24 lb paper.

** “Pages” refers to the “Brother Standard Chart No.1” with MMR Coding System and Standard Resolution.

*** “Pages” refers to the “Brother Standard Chart No.1” with JBIG Coding System and Standard Resolution.

Specifications and printed materials are subject to change without prior notice.

Scanner (Option for FAX-4750e. Standard for 5750e.)



Download the Scanner Driver for FAX-4750e from:
<http://solutions.brother.com>

TWAIN Compliant	Yes
Document Size	ADF Width: 5.8" to 8.5" (148 mm to 216 mm) ADF Length: 3.9" to 14.1" (100 mm to 360 mm)
Resolution	Up to 9,600 × 9,600 (interpolated) Up to 300 × 600 (optical)
Scanning/Printing Width	8.15 inches (208 mm)
Automatic Document Feeder (ADF)	Up to 30 pages* With Conditions: Up to 50 pages*
Gray Scale	256 levels

Consumable Items

Toner cartridge Life Expectancy:

Up to 6,000 pages/*high yield* toner cartridges

Up to 3,000 pages/*standard* toner cartridges

(when printing letter size or A4 paper at 5% print coverage)



Toner life expectancy will vary depending upon the type of average print job.

Drum Unit Life Expectancy: up to 20,000 pages



There are many factors that determine the actual drum life, such as temperature, humidity, type of paper, toner you use and number of pages per print job.

Electrical and Environment

Temperature	Operating 50 - 90.5° F (10 - 32.5° C) Storage 32 - 104° F (0 - 40° C)
Humidity	Operating: 20 to 80% (without condensation) Storage: 20 to 80% (without condensation)
Warm-Up	Max. 25 seconds at 73.4° F (23° C)
First Print	15 seconds (using Letter size paper in paper cassette)
Power Source	120V AC 50/60Hz (USA and Canadian Version Only)
Power Consumption	Average Operating (Copying): 350 W (25° C) Peak: 940 W Sleep Mode: 10 W or less Stand by: 70 W or less (25° C)

Noise	Operating: 53 dB A or less Stand by: 30 dB A or less
Dimensions	FAX-4750e: 17.1 × 17.4 × 12.7 inches (435 × 442 × 323 mm) FAX-5750e: 17.1 × 17.4 × 17 inches (435 × 442 × 432 mm)
Weight	FAX-4750e: 26.4 lbs/(12.0kg) (Without Carton) FAX-5750e: 34.3 lbs/(15.5 kg) (Without Carton)

Printer

Emulation	
FAX-4750e	Brother Printing System for Windows®
FAX-5750e	PCL 5e (Emulation mode of HP LaserJet 5P)
Printer Driver	Windows® 95/98/98SE/Me/2000/XP and Windows NT® Workstation Version 4.0 driver supporting Brother Native Compression mode and bi-directional capability Apple® Macintosh® QuickDraw® Driver for OS 8.5-9.2/OS X v.10/10.1
Interface	Bi-directional parallel (IEEE-1284); USB (Universal Serial Bus) 1.1
Print Method	Electrophotography by semiconductor laser beam scanning
Resolution	600 dots/inch
Print Quality	Normal printing mode Economy printing mode (saves up to 50% of the normal toner usage)
Print Speed	Up to 15 pages/minute (when loading letter size paper from paper cassette)
Output Tray Paper Capacity	150 sheets
Manual Feed Slot	Custom size paper (2.75" × 5 to 8.5" × 14") Envelopes (DL, C5, Com10, Monarch)
Handles these Paper Sizes and Types	Letter, Legal, A4, B5, A5, Executive, OHP Envelopes, Labels, Organizer

TrueType Fonts on CD-ROM

35 TrueType compatible soft-fonts for Windows® on the bundled CD-ROM.
(Available only for FAX-5750e.)

Computer Requirements

Minimum System Requirements					
Computer Platform & Operating System Version		Processor Minimum Speed	Minimum RAM	Recommended RAM	Available Hard Disk Space
Windows® Operating Systems	95, 98, 98SE	Pentium 75MHz	24MB	32MB	50MB
	Me	Pentium 150MHz	32MB	64MB	
	NT® Workstation 4.0	Pentium 75MHz			
	2000 Professional	Pentium 133MHz	64MB	128MB	
	XP*	Pentium 233MHz			
Apple iMac™/iBook™/G3/G4 Operating Systems	OS 8.5 – 8.51 (Printing Only)	All base models meet minimum requirements			50MB
	OS 8.6 – 9.2 (Printing and Scanning)				
	Mac OS X v.10/10.1 (Printing Only)†				
<p>NOTE: USB is not supported under Windows® 95 or Windows NT® 4.0</p> <p>All registered trademarks referenced herein are the property of their respective companies.</p> <p>* Printer Driver and Scanner Driver can be downloaded from http://solutions.brother.com</p> <p>† Printer Driver can be downloaded from http://solutions.brother.com</p>					

Parallel Interface Specifications

Interface Connector Printer Side: Amphenol FCN-685J036-L/X or equivalent
 A shielded cable should be used.

Pin Assignment

Pin No.	Signal	Direction	Pin No.	Signal	Direction
1	DATA STROBE	Input	19	0V(S.G.)	-
2	DATA 1	Input	20	0V(S.G.)	-
3	DATA 2	Input	21	0V(S.G.)	-
4	DATA 3	Input	22	0V(S.G.)	-
5	DATA 4	Input	23	0V(S.G.)	-
6	DATA 5	Input	24	0V(S.G.)	-
7	DATA 6	Input	25	0V(S.G.)	-
8	DATA 7	Input	26	0V(S.G.)	-
9	DATA 8	Input	27	0V(S.G.)	-
10	<u>ACKNLG</u>	Output	28	0V(S.G.)	-
11	BUSY	Output	29	0V(S.G.)	-
12	PE	Output	30	0V(S.G.)	-
13	SLCT	Output	31	<u>INPUT PRIME</u>	Input
14	<u>AUTO FEED</u>	Input	32	<u>FAULT</u>	Output
15	N.C.	-	33	N.C.	-
16	0V (S.G.)	-	34	N.C.	-
17	0V (S.G.)	-	35	N.C.	-
18	+5V	-	36	<u>SLCT IN</u>	Input

USB (Universal Serial Bus) Interface Specifications

Pin Assignment

Pin No.	Signal
1	Vol (+5V)
2	- Data Serial Data -
3	+ Data Serial Data +
4	Ground

Resident Fonts (For FAX-5750e Only)

The following bitmapped fonts are resident in the machine.

Brougham 10 (12 point) upright/normal

Brougham 12 (10 point) upright/normal

Letter Gothic 16.66 (8.5 point) upright/normal

(Portrait and Landscape are available for the above.)

Symbol Sets/Character Sets

*HP mode

- ISO14 JIS ASCII
- ISO57 Chinese
- ISO11 Swedish
- HP Spanish
- ISO17 Spanish
- ISO10 Swedish
- ISO16 Portuguese
- ISO84 Portuguese
- ISO85 Spanish
- PC-8
- PC-8 D/N
- PC-8 Turkish
- PC-850
- PC-852
- PC-860
- PC-865
- Roman 8
- ISO Latin 1
- (ECMA-94)
- ISO60 Norwegian 1
- ISO61 Norwegian 2
- ISO4 UK
- ISO25 French
- ISO69 French
- HP German
- ISO21 German
- ISO15 Italian
- ISO6 ASCII
- Legal
- ISO2 IRV
- PC-863



If you want to know which characters are in each symbol/character set, print the CHARSETS.PRN file from “The Print Form” option in the Direct Access Menu of the Remote Printer Console Program.

IP LaserJet IIP

ISO Latin1

8	9	A	B	C	D	E	F		0	1	2	3	4	5	6	7	8	9	A	B	C	D	E	F
		À	Á	Â	Ã	Ä	Å	ª											À	Á	Â	Ã	Ä	Å
		Ã	Ä	Å	ª	«	»		0	1	2	3	4	5	6	7	8	9	À	Á	Â	Ã	Ä	Å
		È	É	Ê	Ë	Ì	Í	Î	1	"	#	\$	%	&	'	()	*	À	Á	Â	Ã	Ä	Å
		Ï	Ñ	Ò	Ó	Ô	Õ	Ö	2	BR	CS	DT	EU	FV	GW	HX	IY	JZ	À	Á	Â	Ã	Ä	Å
		`	´	ˆ	˜	¨	˚	¸	3	CR	CS	DT	EU	FV	GW	HX	IY	JZ	À	Á	Â	Ã	Ä	Å
		¸	˚	¸	˚	¸	˚	¸	4	DT	DT	DT	DT	DT	DT	DT	DT	DT	À	Á	Â	Ã	Ä	Å
		¸	˚	¸	˚	¸	˚	¸	5	EU	EU	EU	EU	EU	EU	EU	EU	EU	À	Á	Â	Ã	Ä	Å
		¸	˚	¸	˚	¸	˚	¸	6	FV	FV	FV	FV	FV	FV	FV	FV	FV	À	Á	Â	Ã	Ä	Å
		¸	˚	¸	˚	¸	˚	¸	7	GW	GW	GW	GW	GW	GW	GW	GW	GW	À	Á	Â	Ã	Ä	Å
		¸	˚	¸	˚	¸	˚	¸	8	HX	HX	HX	HX	HX	HX	HX	HX	HX	À	Á	Â	Ã	Ä	Å
		¸	˚	¸	˚	¸	˚	¸	9	IY	IY	IY	IY	IY	IY	IY	IY	IY	À	Á	Â	Ã	Ä	Å
		¸	˚	¸	˚	¸	˚	¸	A	JZ	JZ	JZ	JZ	JZ	JZ	JZ	JZ	JZ	À	Á	Â	Ã	Ä	Å
		¸	˚	¸	˚	¸	˚	¸	B	[k	[k	[k	[k	[k	[k	[k	[k	[k	À	Á	Â	Ã	Ä	Å
		¸	˚	¸	˚	¸	˚	¸	C	[l	[l	[l	[l	[l	[l	[l	[l	[l	À	Á	Â	Ã	Ä	Å
		¸	˚	¸	˚	¸	˚	¸	D	[m	[m	[m	[m	[m	[m	[m	[m	[m	À	Á	Â	Ã	Ä	Å
		¸	˚	¸	˚	¸	˚	¸	E	[n	[n	[n	[n	[n	[n	[n	[n	[n	À	Á	Â	Ã	Ä	Å
		¸	˚	¸	˚	¸	˚	¸	F	[o	[o	[o	[o	[o	[o	[o	[o	[o	À	Á	Â	Ã	Ä	Å

The following table shows characters available only in the corresponding character set. The numbers at the top of the table are code values with which characters are to be replaced in the Roman 8 character set. For other characters, see character set of Roman 8.

	23	24	40	5B	5C	5D	5E	60	7B	7C	7D	7E
	#	□	@	[\]	^	~	{		}	—
	E	\$	@	[\]	^	~	{		}	—
	#	\$	@	[\]	^	~	{		}	—
	#	□	@	Ä	Ö	Å	Ü	ä	ö	å	ü	—
[I	#	□	É	Ä	Ö	Å	Ü	ä	ö	å	ü	—
	E	\$	\$	[Ÿ]	é	ù	{		}	—
ase	#	\$	\$	Ä	Ç	Ö	~	ä	ç	ò	è	ì
	E	\$	\$	i	Ç	Ö	~	ä	ç	ñ	ç	—
	#	\$	\$	Ä	Ö	Ü	~	ä	ö	ü	è	B
	E	\$	\$	à	Ç	Ü	~	é	ù	è	—	—
	#	Ÿ	@	{	\	}	~	~	{		}	—
an1	#	\$	@	E	Ø	Å	~	æ	ø	å	—	—
an2	\$	\$	@	E	Ø	Å	~	æ	ø	å		—
	E	\$	\$	à	Ç	Ü	~	µ	é	ù	è	—
ase	#	\$	·	Ä	Ç	Ö	~	ä	ç	ò	ç	—
	#	\$	·	i	Ç	Ö	~	ä	ç	ñ	ç	—
	E	\$	\$	Ä	Ö	Ü	~	ä	ö	ü	—	B
	#	\$	@	i	Ç	Ö	~	{		}	—	—

Index

A

- access codes for dialing, storing 7-7
- accessories and supplies ii
- ADF (automatic document feeder) 6-1
- assembly 2-3
 - document tray 2-4
 - document wire 2-4
 - drum unit 2-3
 - grounded three-prong plug 2-9
 - handset 2-9
 - loading paper 2-7
 - power cord 2-9
 - telephone line code 2-9
- Toner Cartridge 2-3
- automatic
 - dialing 7-5
 - fax receive 5-1
 - fax redial 6-2
 - transmission 6-2
- automatic fax receive 5-1

B

- Backup Print 9-3
- Broadcasting 7-6
 - setting up Groups for 7-3
- Brother
 - accessories and supplies ii
 - Brother numbers i
 - Brother Solutions Center i
 - Customer Service i
 - fax-back system i
 - Frequently Asked Questions (FAQs) i
 - on the World Wide Web i
 - product Support i
 - Test Sheet, sending 1-2
 - warranties
 - Canada vi
 - Notice-Disclaimer of Warranties iii
 - USA iv, v
- Brother Control Center

- using and configuring 14-2 to 14-14

C

- Caller ID 8-3
- canceling
 - fax forwarding 9-1, 9-5, 9-6
 - fax jobs in memory 5-8, 6-4
 - jobs awaiting redial 6-4
 - paging 9-5
- cleaning (routine maintenance)
 - drum unit 19-19
 - printer 19-18
 - scanner 19-18
- computer requirements S-5
- Connecting
 - external answering machine 2-10
 - external telephone 2-10
- control panel keys 1-3
- converting telephone wall outlets 2-12
- copy
 - contrast 11-4, 11-8
 - default settings 11-7
 - enlarging 11-3
 - keys 11-1
 - multiple 11-1
 - photographs 11-4, 11-7
 - quality 19-12
 - reducing 11-3
 - scannable area 11-1
 - single 11-1
 - sorting 11-5
 - temporary settings 11-2
 - using ADF 6-1
- cover page
 - composing 6-6
 - custom comments 6-7
 - for all faxes 6-8
 - for next fax only 6-7
 - printed form 6-8
- credit card numbers, storing 7-7

custom telephone features 2-14, 19-8

Customer Service i

D

date and time, setting 4-2

dialing

access codes 7-7

automatic fax redial 6-2

credit card numbers 7-7

fax redial 7-7

Groups 7-6

manually 7-4

mode (for Canada) 4-8

One Touch numbers 7-5

Search 7-4

Speed Dial numbers 7-5

Drivers

Macintosh®

printer 17-1

scanner 17-1, 17-8

Windows®

PC-FAX 16-15

printer 12-1

scanner 15-8

drum unit

checking life remaining 19-24

installing 2-3

replacing 19-23

Dual Access 6-3

E

ECM (Error Correction Mode) 1-6

emergency numbers 20-1

entering text 4-4

error messages on LCD 19-1

CHECK PAPER 19-1

COMM. ERROR 19-1

NOT REGISTERED 19-2

OUT OF MEMORY 19-2

extension telephones, using 5-5

external answering machine 2-11

external telephone connecting 2-10

F

fax

codes

Fax Receive Code 5-5

Remote Retrieval Access Code 9-3

Telephone Answer Code 5-5

Fax Forwarding

changing remotely 9-5, 9-6

programming a number 9-1

setting up at machine 9-1

fax receive 5-1

Fax Storage

printing from 5-6

setting 9-3

fax, stand-alone

receiving 5-1

difficulties 19-6

erasing from memory 9-5

forwarding 9-1, 9-5

polling 5-7

printing from memory 5-6

reducing to fit on paper 5-3

retrieving from a remote site 9-6

sending 6-5

automatic fax redial 6-2

automatic transmission 6-2

Broadcasting 7-6

canceling jobs in memory 6-4

contrast 6-5

delayed 6-10

from memory (Dual Access) 6-3

in real time 6-3

manual transmission 6-2

overseas 6-9

polling 6-11

resolution 6-5

timer for delayed sending 6-9

using multiple settings 6-2

FAX/TEL mode 5-1, 5-2

answering at extension phones 5-5

double-ringing (voice calls) 5-2

Easy Receive 5-3

FAX Receive Code 5-5

receiving faxes 5-5

Setting F/T Ring Time 5-2
Setting Ring Delay 5-2
Telephone Answer Code 5-5
FCC Notices 20-1

G

Groups
dialing 7-6

J

jacks
converting telephone wall outlets 2-12
EXT. jack on machine
TAD (answering machine) 2-10
EXT. jack on machine external telephone
2-10
triplex adapter 2-12

L

LCD (Liquid Crystal Display) 3-1

M

maintenance, routine 19-18
manual
mode 5-1
sending 6-2
manual feed slot 2-6
Memory Security 5-6
Menu mode
programming at a glance 3-1
Menu table 3-3
Multi-Function Link[®] Pro (MFL-Pro) 14-1, 15-5, 16-1

O

OCR (ScanSoft[™] TextBridge[®]) 15-5
One Touch numbers
accessing with Shift key 7-1
changing 7-2
dialing 7-5
listing 10-2
storing 7-1

optional accessories 18-1
memory 18-1
Network LAN board 18-4
Paper Cassette #2 18-4

P

packing list 2-1
Paging, programming a number 9-2
paper
cassette 2-8
jams 19-4
loading 2-7
size 2-6, 4-1
specifications S-2
PaperPort[®] for Brother
exporting an image file 15-12
prescanning an image 15-1, 15-8
scanning into PC
accessing 15-8
exporting 15-12
importing 15-11
settings 15-3, 15-10
uninstall 15-12
viewing faxes and files 15-6
PC-FAX (For Windows[®]) 16-3
sending
address book 16-7
cover page 16-12
facsimile style 16-15
group 16-9
setting up 16-3
simple style 16-14
phone line
connection 2-9
difficulties 19-7, 19-8
multi-line (PBX) 2-14
roll-over lines 2-12
two-line system 2-12, 2-13
polling
receiving 5-7
sending 6-11
sequential receiving 5-8

power
 cord 2-9
 electrical outlet 2-9
 failure 4-7

Print
 density 5-4
 difficulties 19-10
 drivers
 Apple® Macintosh® 17-1
 Windows® 12-1
 emulation
 Macintosh® 17-1
 envelopes 2-6
 quality 19-12, 19-13, 19-14
 resolution S-4
 Specifications S-4
 Speed S-4
 two-sided (manual duplex) 12-6
 Windows® 12-1

printer
 cleaning 19-18
 jam 19-4

Printer Driver 12-1

R

Real Time Transmission 6-3

Receive Mode 5-1
 FAX 5-1
 FAX/TEL 5-1
 MANUAL 5-1
 TAD, external 2-10, 5-1

redial 6-2, 7-7

remote fax options 9-1

Remote Retrieval 9-4
 access code, using 9-4
 commands 9-5
 getting your faxes 9-6

reports 10-1
 HELP (programming at-a-glance) 10-2
 how to print 10-2
 list of your stored numbers 10-2
 Transmission Verification 10-2

resolution
 copy S-1
 fax (Standard, Fine, Super Fine, Photo) S-2
 print S-4
 scan 15-3, 15-10, S-3

Ring Delay, setting 5-2

S

Safety Instructions 20-4

scan
 Macintosh® 17-7
 Windows® 15-1

scanner, cleaning 19-18

Search 7-4

shipping the machine 19-15

Sleep mode 4-8

software (Macintosh®)
 faxing 17-3
 scanner setting 17-10
 Prescanning into Macintosh 17-8
 printing with Brother driver 17-1
 scanning with Brother TWAIN driver 17-7

software (Windows®)
 Brother Control Center 14-1
 for DOS users 13-1
 PaperPort® for Brother
 exporting an image file 15-12
 PC-FAX 16-3
 prescanning an image 15-1, 15-8
 scanning into PC 15-3, 15-8, 15-10
 uninstall 15-12
 viewing faxes and files 15-6
 ScanSoft™ TextBridge® OCR 15-5

Speed Dial
 changing 7-2
 dialing 7-5
 listing 10-2
 storing 7-2

Station ID (fax header) 4-3

T

- TAD (telephone answering device), external
 - connecting 2-10
 - recording outgoing message 2-11
- Telephone Answer Code 5-5
- text, entering 4-4
 - corrections 4-4
 - special characters 4-4
- toner cartridge
 - installing 2-3
 - replacing 19-20
 - Toner Save 4-8
- transparencies 2-5
- troubleshooting
 - document jam 19-4
 - error messages on LCD 19-1
 - if you are having difficulty
 - copy quality 19-12
 - incoming calls 19-8
 - paper handling 19-11
 - phone line connections 19-7
 - printer 19-9
 - printing or receiving faxes 19-6
 - scanning 19-11
 - sending faxes 19-7
 - software 19-10
- two-line phone system 2-12, 2-13

U

- User Settings 10-2

V

- volume, setting
 - amplify for hearing impaired 4-6, 4-7
 - beeper 4-5
 - ring 4-5
 - speaker 4-5

W

- warranties
 - Canada vi
 - Disclaimer–User Installation of Memory Board(s) iii
 - Notice of Disclaimer iii
 - USA iv, v
- World Wide Web i

Remote Retrieval Access Card

If you plan to receive fax messages while away from your machine, carrying the Remote Retrieval Access Card printed below will serve as a convenient reminder of the retrieval procedures. Simply cut out the card and fold it to fit your wallet or organizer. Keeping it handy will help you derive the full benefit of your machine's Forwarding, Paging and Remote Retrieval features.

REMOTE RETRIEVAL ACCESS CARD

← Fold

CHECK RECEIVING STATUS
Press **9 7 1**
1 long beep — Fax message(s)
3 short beeps — No messages

CHANGE ANSWER MODE
Press **9 8**
then for TAD, press **1**.
FAX/TEL (Fax/Telephone), press **2**.
FAX, press **3**.

EXIT REMOTE OPERATION
Press **9 0**.



Using Remote Access Code

- 1 Dial your fax number from a fax machine using touch tone.
- 2 When your machine answers and beeps, immediately enter your Remote Retrieval Access Code (159✳).
- 3 Your machine signals the kinds of messages received:
1 long beep — Fax message(s)
No beeps — No messages.
- 4 After 2 short beeps, enter a command.
- 5 Press **9 0** to reset your machine when you finish.
- 6 Hang up.

→ Fold

1

4



Changing Remote Retrieval Access Code

- 1 Press **Menu 2, 5, 3**.
- 2 Enter a three-digit number from 000 to 999.
The * cannot be changed.
- 3 Press **Set**.
- 4 Press **Stop/Exit**.

Remote Commands

CHANGE PAGING/FAX FORWARDING SETTING

- Press **9 5**. Turn feature off, press **1**,
then to Select Fax Forwarding, press **2**.
Select Paging, press **3**.

Program Fax Forwarding Number press **4**. Enter the new fax number where you want your fax messages forwarded followed by **# #**.

Turn Fax Storage ON, press **6**.
Turn Fax Storage OFF, press **7**.

RETRIEVE A FAX

Press **9 6**.
then to Retrieve all faxes, press **2**,
then enter the number of remote fax machine followed by
#. After the beep, hang up and wait.
Erase all fax messages, press **3**.

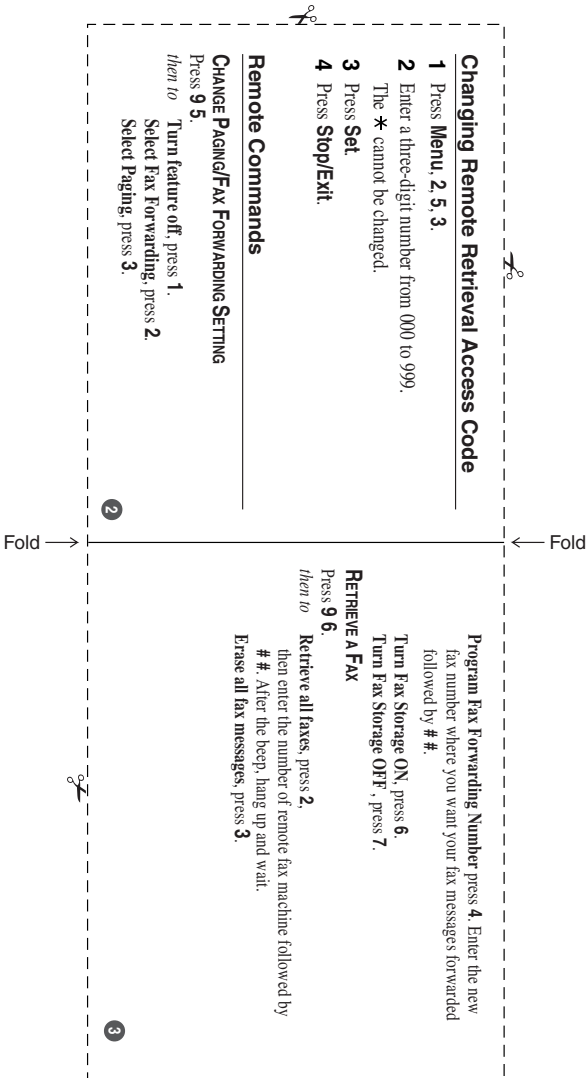

EQUIPMENT ATTACHMENT LIMITATIONS (For Canada Only)

NOTICE:

This equipment meets the applicable Industry Canada Terminal Equipment Technical Specifications. This is confirmed by the registration number. The abbreviation, IC, before the registration number signifies that registration was performed based on a Declaration of Conformity indicating that Industry Canada technical specifications were met. It does not imply that Industry Canada approved the equipment.

NOTICE:

The Ringer Equivalence Number (REN) for this terminal equipment is 0.2. The REN assigned to each terminal equipment provides an indication of the maximum number of terminals allowed to be connected to a telephone interface. The termination on an interface may consist of any combination of devices subject only to the requirement that the sum of the Ringer Equivalence Numbers of all the devices does not exceed five.

brother®

Brother International Corporation
100 Somerset Corporate Boulevard
P.O. Box 6911
Bridgewater, NJ 08807-0911 USA

Brother International Corporation (Canada) Ltd.
1 rue Hôtel de Ville,
Dollard-des-Ormeaux, QC, CANADA H9B 3H6

**Visit us on the World Wide Web
<http://www.brother.com>**

These machines are made for use in the USA and CANADA only. We cannot recommend using them overseas because it may violate the Telecommunications Regulations of that country and the power requirements of your fax machine may not be compatible with the power available in foreign countries. **Using USA or CANADA models overseas is at your own risk and will void your warranty.**