

TOSHIBA

MULTIFUNCTIONAL DIGITAL SYSTEMS

Operator's Manual for Facsimile Function

GD-1170



CONTENTS

NOTICE TO USERS	3
Preface	8
Features of the GD-1170	9
General Precautions	10
• When power failure occurs	10
1. BEFORE USING FAX	13
1. Description of Each Component	14
• Main components	14
• Configuration of options	15
• Control panel	16
• Touch panel	18
• Connecting cables	20
2. SENDING A FAX	21
1. Transmission Mode	22
2. Preparation for Transmission	24
3. About Originals	25
• Original size/Original scanning range	25
• Setting originals	26
4. Setting the Transmission Conditions	29
• Variety of optional functions	29
• Setting the transmission conditions	31
• Sending different width originals	33
• Setting the scanning conditions for each page	35
5. Specifying the Remote Fax	37
• Direct entry with digital keys	37
• Address book entry	38
• Group entry	39
• Searching by ID number	40
• Searching by address (Search address)	42
• Searching address using LDAP server	45
• Multi-address transmission	47
• Confirming the destinations	48
6. Sending Originals	49
• Direct transmission	49
• Memory transmission	51
• Other transmissions	53
• Sending a Tone	55
3. RECEIVING A FAX	57
1. Reception Modes	58
2. Reception Settings	59
3. Relationship between Original and Paper	62
4. CHECKING AND CANCELING THE COMMUNICATIONS	65
1. Checking Transmission Result	66
• Checking reserved transmissions	66
• Checking communication status (log)	68
• Address registration from send/receive log	70
2. Canceling Transmissions	72
5. ADVANCED FUNCTIONS	77
1. Transmitting 2-Sided Originals	78
2. Priority Transmission	80
3. Polling Communication	81
4. Mailbox Communication	84
5. Chain Dial Communication	104
6. Delayed Transmission Reservation	106
7. Recovery Transmission	109
8. Onramp Gateway	111
9. Offramp Gateway	113
10. Save as File	115
6. PRINTING LISTS AND REPORTS	119
1. Manually Printing Lists & Reports	120
2. Automatically Printing Lists & Reports	124
• Automatically printing lists & reports	124

• Setting the lists and reports output	125
3. Lists/Reports Samples	133
7. REGISTERING AND SETTING ITEMS.....	147
1. Setting the Initial Transmission Mode	148
2. Registering the Terminal ID	150
3. Setting the Reception Mode.....	155
4. Setting RX Printing.....	158
• Setting RX printing.....	158
• Setting duplex printing	161
• Setting the rotate sort (Alternation).....	164
5. Setting Recovery Transmission	166
8. TROUBLESHOOTING	169
1. When The Following Messages Appear	170
2. Transmission Trouble	171
3. Reception Trouble.....	172
9. SPECIFICATIONS	173
1. Main Specifications	174

NOTICE TO USERS

For U.S.A. only

WARNING FCC Notice: Part 15

This terminal has been tested and found to comply with the limits for a Class A digital device, pursuant to Part 15 of the FCC Rules. These limits are designed to provide reasonable protection against harmful interference when the equipment is operated in a commercial environment. This equipment generates, uses, and can radiate radio frequency energy and, if not installed and used in accordance with this guide, may cause harmful interference to radio communications. Operation of this terminal in a residential area is likely to cause harmful interference in which case the user will be required to correct the interference at his/her own expense.

Warning: Changes or modification made to this equipment, not expressly approved by Toshiba TEC or parties authorized by Toshiba TEC could void the user's authority to operate the equipment.

WARNING FCC Notice: Part 68

This equipment complies with Part 68 of the FCC rules and the requirements adopted by the ACTA. On the rear cover of this equipment is a label that contains, among other information, a product identifier in the format US: AAAEQ##TXXXX. If requested, this number must be provided to the telephone company.

This device is equipped with a USOC RJ11C connector.

A plug and jack used to connect this equipment to the premises wiring and telephone network must comply with the applicable FCC Part 68 rules and requirements adopted by the ACTA. A compliant telephone cord and modular plug is provided with this product. It is designed to be connected to a compatible modular jack that is also compliant. See installation instructions for details.

The REN is used to determine the number of devices that may be connected to a telephone line. Excessive RENs on a telephone line may result in the devices not ringing in response to an incoming call. In most but not all areas, the sum of RENs should not exceed five (5.0). To be certain of the number of devices that may be connected to a line, as determined by the total RENs, contact the local telephone company. For products approved after July 23, 2001, the REN for this product is part of the product identifier that has the format US: AAAEQ##TXXXX. The digits represented by ## are the REN without a decimal point (e.g., 03 is a REN of 0.3).

For earlier products, the REN is separately shown on the label.

If this equipment causes harm to the telephone network, the telephone company will notify you in advance that temporary discontinuance of service may be required. But if advance notice isn't practical, the telephone company will notify the customer as soon as possible. Also, you will be advised of your right to file a complaint with the FCC if you believe it is necessary.

The telephone company may make changes in its facilities, equipment, operations or procedures that could affect the operation of the equipment. If this happens the telephone company will provide advance notice in order for you to make necessary modifications to maintain uninterrupted service.

If trouble is experienced with this equipment, for repair or warranty information, please contact Toshiba America Business Solutions Electronic Imaging Division at 1-800-468-6744. If the equipment is causing harm to the telephone network, the telephone company may request that you disconnect the equipment until the problem is resolved.

Connection to party line service is subject to state tariffs. Contact the state public utility commission, public service commission or corporation commission for information.

The Telephone Consumer Protection Act of 1991 makes it unlawful for any person to use a computer or other electronic device, including Fax machines, to send any message unless such message clearly contains in a margin at the top or bottom of each transmitted page or on the first page of the transmission, the date and time it is sent and an identification of the business or other entity, or other individual sending the message and the telephone number of the sending machine or such business, other entity, or individual. (The telephone number provided may not be a 900 number or any other number for which charges exceed local or long-distance transmission charges.)

In order to program this information into your Fax machine, you should complete the following steps: complete the setup procedures listed for station ID number and name. See  P.150 "2.Registering the Terminal ID".

CAUTION – To reduce the risk of fire, use only No.26 AWG or larger telecommunication line cord.

TOSHIBA AMERICA BUSINESS SOLUTIONS, INC.

Electronic Imaging Division
2 Musick, Irvine, CA 92618-1631

For Canada only

NOTICE: The Industry Canada label identifies certified equipment. This certification means that the equipment meets telecommunications network protective, operational and safety requirements as prescribed in the appropriate Terminal Equipment Technical Requirements document(s). The Department does not guarantee the equipment will operate to the user's satisfaction.

Before installing this equipment, users should ensure that it is permissible to be connected to the facilities of the local telecommunications company. The equipment must also be installed using an acceptable method of connection. The customer should be aware that compliance with the above conditions may not prevent degradation of service in some situations.

Repairs to certified equipment should be coordinated by a representative designated by the supplier. Any repairs or alterations made by the user to this equipment, or equipment malfunctions, may give the telecommunications company cause to request the user to disconnect the equipment.

Users should ensure for their own protection that the electrical ground connections of the power utility, telephone lines and internal metallic water pipe system, if present, are connected together. This precaution may be particularly important in rural areas.

CAUTION: Users should not attempt to make such connections themselves, but should contact the appropriate electric inspection authority, or electrician, as appropriate.

The Ringer Equivalence Number of your facsimile is 0.3

NOTICE: The Ringer Equivalence Number (REN) assigned to each terminal device provides an indication of the maximum number of terminals allowed to be connected to a telephone interface. The termination on an interface may consist of any combination of devices subject only to the requirement that the sum of the Ringer Equivalence Numbers of all the devices does not exceed 5.

CAUTION – To reduce the risk of fire, use only No.26 AWG or larger telecommunication line cord.

AVIS: L'étiquette d'Industrie Canada identifie le matériel homologué. Cette étiquette certifie que le matériel est conforme aux normes de protection, d'exploitation et de sécurité des réseaux de télécommunications, comme le prescrivent les documents concernant les exigences techniques relatives au matériel terminal.

Le Ministère n'assure toutefois pas que le matériel fonctionnera à la satisfaction de l'utilisateur. Avant d'installer ce matériel, l'utilisateur doit s'assurer qu'il est permis de le raccorder aux installations de l'entreprise locale de télécommunication. Le matériel doit également être installé en suivant une méthode acceptée de raccordement. L'abonné ne doit pas oublier qu'il est possible que la conformité aux conditions énoncées ci-dessus n'empêche pas la dégradation du service dans certaines situations.

Les réparations de matériel homologué doivent être coordonnées par un représentant désigné par le fournisseur. L'entreprise de télécommunications peut demander à l'utilisateur de débrancher un appareil à la suite de réparations ou de modifications effectuées par l'utilisateur ou à cause de mauvais fonctionnement.

Pour sa propre protection, l'utilisateur doit s'assurer que tous les fils de mise à la terre de la source d'énergie électrique, des lignes téléphoniques et des canalisations d'eau métalliques, s'il y en a, sont raccordés ensemble. Cette précaution est particulièrement importante dans les régions rurales.

Avertissement: L'utilisateur ne doit pas tenter de faire ces raccordements lui-même; il doit avoir recours à un service d'inspection des installations électriques, ou à un électricien, selon le cas.

L'indice d'équivalence de la sonnerie de ce matériel 0.3.

AVIS: L'indice d'équivalence de la sonnerie (IES) assigné à chaque dispositif terminal indique le nombre maximal de terminaux qui peuvent être raccordés à une interface. La terminaison d'une interface téléphonique peut consister en une combinaison de quelques dispositifs, à la seule condition que la somme d'indices d'équivalence de la sonnerie de tous les dispositifs n'excède pas 5.

ATTENTION – Pour réduire les risques d'incendie, utiliser uniquement des conducteurs de télécommunications 26 AWG ou de section supérieure.

This Class A digital apparatus complies with Canadian ICES-003.

Cet appareil numérique de la classe A est conforme à la norme NMB-003 du Canada.

TOSHIBA OF CANADA LIMITED

Office Product Group
191 McNABB STREET
MARKHAM, ONTARIO L3R 8H2

For NEW ZEALAND only

"The grant of a Telepermit for any item of terminal equipment indicates only that Telecom has accepted that the item complies with minimum conditions for connection to the network. It indicates no endorsement of the product by Telecom, nor does it provide any sort of warranty. Above all, it provides no assurance that any item will work correctly in all respects with another item of Telepermitted equipment of a different make or model, nor does it imply that any is compatible with all of Telecom's network services."

"This equipment is not capable, under all operating conditions, of correct operation at the higher speeds for which it is designated. Telecom will accept no responsibility should difficulties arise in such circumstances."

"This equipment should not be used any circumstances which may constitute a nuisance to other Telecom customers."

"Not all telephones will respond to incoming ringing when connected to the extension socket."

“This device is equipped with pulse dialling while the Telecom standard is DTMF tone dialling. There is no guarantee that Telecom lines will always continue to support pulse dialling”

“Use of pulse dialling, when this equipment is connected to the same line as other equipment, may give rise to bell tinkle or noise and may also cause a false answer condition. Should such problems occur, the user should NOT contact the Telecom Faults Service”

“This device is intended for Stand-alone connection and not in parallel with other telephone devices”

“The call log incorporated in this equipment does not record all answered calls. The call log, therefore may not agree with the Telecom account which may include calls not shown on the log.”

“If a charge for local calls is unacceptable, the ‘Dial’ button should NOT be used for local calls. Only the 7-digits of the local number should be dialled from your telephone. DO NOT dial the area code digit or the ‘0’ prefix”

TOSHIBA (AUSTRALIA) PTY LIMITED

Level 1, Building 2, Central Park
666 Great South Road,
Penrose, Auckland
New Zealand
Phone: 64 9 526 7716

Warning: This is a Class A product. In a domestic environment this product may cause radio interference in which case the user may be required to take adequate measures.

Working environment

From EMC (Electromagnetic Compatibility) point of view, the operation of this product is being restricted in following environments:

- Medical Environments: This product is not certified as a medical product according to the Medical Product Directive 93/42/EEC.
- Domestic environments (e.g. a private living room with TV / Radio sets in the nearby surrounding area) because this is a so called EMC class A product. In a domestic environment this product may cause radio interference in which case the user may be required to take adequate measures!

Any consequences resulting from the use of this product in restricted working environments are not the responsibility of TOSHIBA TEC.

The consequences of the use of this product in restricted working environments may be an electromagnetic interference with other devices or machines in the nearby surrounding area. This can result into malfunction including data loss / data error pertaining to, this product or the other devices / machines involved in the electromagnetic interference.

Furthermore, for general safety reasons, the use of this product in environments with explosive atmospheres is not permitted.

CE compliance

This product is labelled with the CE mark in accordance with the provisions of the applicable European Directives, notably the Low Voltage Directive 73/23/EEC, the Electromagnetic Compatibility Directive 2004/108/EEC and the Radio Equipment and Telecommunications Terminal Equipment Directive 99/5/EEC.

CE marking is the responsibility of TOSHIBA TEC GERMANY IMAGING SYSTEMS GmbH, Carl-Schurz-Str. 7, 41460 Neuss, Germany, phone +49-(0)-2131-1245-0.

For a copy of the related CE Declaration of Conformity please contact your dealer or TOSHIBA TEC.

Preface

Thank you for purchasing the Toshiba fax unit GD-1170. This Operator's Manual describes the following:

- How to use the Fax functions
- How to perform a Fax communication
- How to inspect this equipment and perform its maintenance
- How to remedy Fax communication problems

Before using this equipment, thoroughly read and understand this Operator's Manual. To ensure that the Fax functions are used in optimum working conditions, keep this Operator's Manual in a handy place for future reference.

Accessories Provided for Fax Function

- Modular cord: 1
- Operator's Manual for Facsimile Functions: 1

To ensure correct and safe use of the functions of the GD-1170, this Operator's Manual describes safety precautions according to the level of warning.

Before reading this Operator's Manual, you should fully understand the meaning and importance of the signal words. These words are classified in the following three levels:

Warning:

Indicates a potentially hazardous situation which, if not avoided, could result in death, serious injury, serious damage, or fire in the equipment or surrounding assets.

Caution:

Indicates a potentially hazardous situation which, if not avoided, may result in minor or moderate injury, partial damage of the equipment or surrounding assets, or loss of data.

Note:

Indicates a procedure you should follow to ensure the optimal performance of the equipment and problem-free copying.

Tip:

Describes useful information when users are operating the equipment.

The contents of this manual may change without notification.

Company or product name shown in this manual may be a brand name or a trademark of each company.

©2005 TOSHIBA TEC CORPORATION All rights reserved

Under the copyright laws, this manual cannot be reproduced in any form without prior written permission of TOSHIBA TEC CORPORATION. No patent liability is assumed, however, with respect to the use of the information contained herein.

Features of the GD-1170

- **Super G3 High-Speed Communication**

High-speed communication in the Super G3 mode is enabled.

* "Super G3 Fax" is an appellation of Fax machines with a modem compatible with ITU-T V.34, which is a new high-speed modem standard.

- **JBIG Encoding System**

This device uses a JBIG encoding system compatible with standard recommendations of ITU-T T.85.

- **Mailbox Communication**

This equipment is compatible with mailbox communications (e.g. confidential communication, bulletin board communication, multi-address relay mail communication).

- **Plain Paper Recording**

Plain paper is used as the Fax output paper. This means that Faxes output from the digital copier can be stored as business documents. You can also write on and sign them.

- **Address Book for 1000 Destinations**

Destinations can be numbered from 001 to 1000 for the address book.

- **Dual Access**

The following operations are enabled using the memory function:

- Reserving a memory transmission during another memory transmission
- Reserving a memory transmission during a reception
- Copying during a memory transmission
- Receiving data while copying
- Receiving data while printing other received data
- Receiving data while printing a list
- Transmitting data in the memory during printing a report

- **High-Resolution (U-FINE) Mode**

Detailed technical drawings, fine text and photographs can be clearly reproduced in transmitted documents with a resolution of 16 dots/mm X 15.4 lines/mm.

- **Multi-Address Transmission**

This function enables you to transmit a single document to maximum 400 destinations in one operation by a direct dialing (using digital keys), or by specifying desired destinations in the address book (either an individual destination or a registered group of destinations). The Internet Fax can be used in combination with this multi-address transmission.

- **A3-Size Data Transmission and Recording**

A3/LD originals such as technical drawings can be transmitted without changing their size. The received data is printed out at the receiver's Fax machine in A3/LD size (if available).

- **2-Sided Transmission**

The data of a 2-sided original can be transmitted in the exact page order of the original by scanning the data with the Reversing Automatic Document Feeder.

- **2-Sided Printing**

You can reduce paper waste by printing received data on both sides of the recording paper.

General Precautions

When power failure occurs

- Neither Fax nor telephone functions of the device are available in the event of a power failure.
- You can use the external telephone to dial a number to make a call or to receive a call.
(See the operator's manual of your telephone set for details.)
- The originals stored in the memory might be deleted completely.
- Settings or registration contents such as the date and time or the address book data will not be deleted.
- All data pertaining to time and destinations set in a certain function such as a delayed communication or polling reception may be deleted.
- If a power failure has occurred during the scanning of an original or while printing a list, the message "POWER FAILURE" appears on the touch panel. In this case, the job in progress might have been deleted due to the power failure. Check the communication status.
- If the data of originals stored in a memory has been deleted due to the power failure, a power failure list will be printed out when power is restored.

Disclaimer Notice

The following notice sets out the exclusions and limitations of liability of TOSHIBA TEC CORPORATION (including its employees, agents and sub-contractors) to any purchaser or user (hereafter "User") of the e-STUDIO520/600/720/850, including its accessories, options and bundled software (hereafter "Product").

1. The exclusion and limitations of liability referred to in this notice shall be effective to the fullest extent permissible at law. For the avoidance of doubt, nothing in this notice shall be taken to exclude or limit TOSHIBA TEC CORPORATION's liability for death or personal injury caused by TOSHIBA TEC CORPORATION's negligence or TOSHIBA TEC CORPORATION's fraudulent misrepresentation.
2. All warranties, conditions and other terms implied by law are, to the fullest extent permitted by law, excluded and no such implied warranties are given or apply in relation to the Products.
3. TOSHIBA TEC CORPORATION shall not be liable for any loss, cost, expense, claim or damage whatsoever caused by any of the following:
 - use of handling of the Product otherwise than in accordance with the manuals, including but not limited to the Operator's Manual, User's Guide, and/or incorrect or careless handling or use of the Product;
 - any cause which prevents the Product from operating or functioning correctly which arises from or is attributable to either acts, omissions, events or accidents beyond the reasonable control of TOSHIBA TEC CORPORATION including without limitation acts of God, war, riot, civil commotion, malicious or deliberate damage, fire, flood, or storm, natural calamity, earthquakes, abnormal voltage or other disasters;
 - additions, modifications, disassembly, transportation, or repairs by any person other than service technicians authorized by TOSHIBA TEC CORPORATION; or
 - use of paper, supplies or parts other than those recommended by TOSHIBA TEC CORPORATION.
4. Subject to paragraph 1, TOSHIBA TEC CORPORATION shall not be liable to Customer for:
 - loss of profits, loss of sales or turnover; loss of or damage to reputation; loss of production; loss of anticipated savings; loss of goodwill or business opportunities; loss of customers; loss of, or loss of use of, any software or data; loss under or in relation to any contract; or
 - any special, incidental, consequential or indirect loss or damage, costs, expenses, financial loss or claims for consequential compensation;

whatsoever and howsoever caused which arise out of or in connection with the Product or the use of handling of the Product even if TOSHIBA TEC CORPORATION is advised of the possibility of such damages. TOSHIBA TEC CORPORATION shall not be liable for any loss, cost, expense, claim or damage caused by any inability to use (including, but not limited to failure, malfunction, hang-up, virus infection or other problems) which arises from use of the Product with hardware, goods or software which TOSHIBA TEC CORPORATION has not directly or indirectly supplied.

1. BEFORE USING FAX

1. Description of Each Component	14
• Main components	14
• Configuration of options	15
• Control panel	16
• Touch panel	18
• Connecting cables	20

1. Description of Each Component

Main components

1

e-STUDIO520/600/720/850

1. Touch panel contrast adjustment dial
2. Toner cover
3. Front cover
4. Drawers
5. Reversing Automatic Document Feeder (RADF)
6. Operator's Manual pocket (Back side)
7. Bypass cover
8. Bypass tray
9. Paper feed cover
10. Paper size indicator
11. Original cover
12. Original scale
13. Scanning area
14. Power switch
15. Toner cartridge
16. Exit cover
17. Original glass
18. Touch panel
19. Control panel
20. Toner cartridge holder
21. Transfer/Transport unit

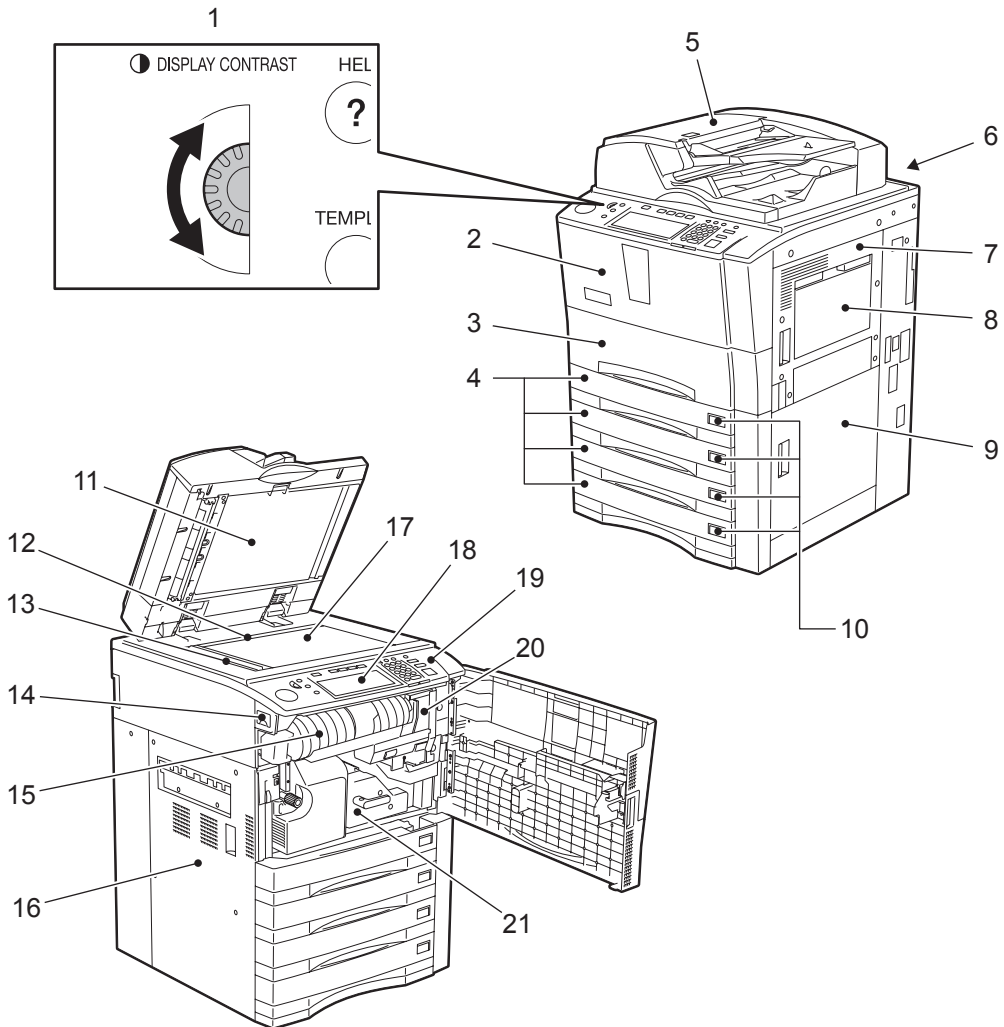

Configuration of options

1

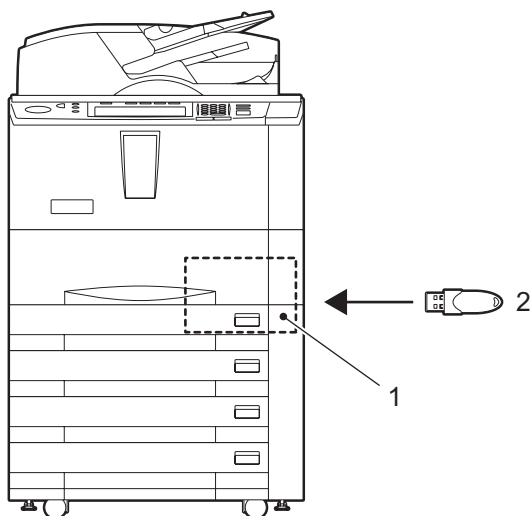

1. **FAX Unit (GD-1170)**
This unit enables you to transmit and receive FAX data.
2. **“Printer Kit (GM-1050) and Scanner Kit (GM-4010)” or “Printer/Scanner Kit (GM-2040)”**
Enables Internet FAX function and Save as File function for e-STUDIO520/600/720/850.

Control panel

Use the buttons on the control panel for various operations and settings through the e-STUDIO520/600/720/850.

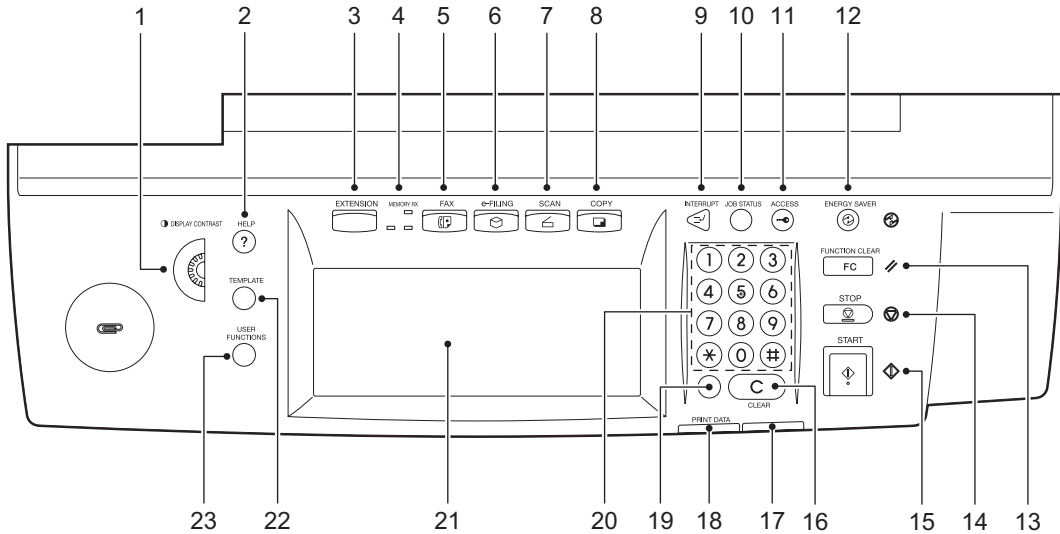

1. **Touch panel contrast adjustment dial**
Adjust the contrast of the touch panel with this dial.
2. **[HELP] button**
Use this button to display a desired operation procedure.
3. **[EXTENSION] button**
Any operation with this button is invalid at present. This button is to extend functions in the future.
4. **MEMORY RX / FAX communication lamps**
These lamps show the status of FAX data reception and FAX communication.
5. **[FAX] button**
Use this button to use the FAX / Internet FAX function.
6. **[e-FILING] button**
Use this button to access saved image data.
7. **[SCAN] button**
Use this button to use the scanning function.
8. **[COPY] button**
Use this button to use the copier function.
9. **[INTERRUPT] button**
Use this button to interrupt the copy job in process and perform another one. The interrupted job is resumed by your pressing this button again.

10. [JOB STATUS] button

Use this button to confirm the job status, printing status, and FAX transmission/reception status of a print job, scan job and FAX job. (📖 P.66 “1.Checking Transmission Result”)

11. [ACCESS] button

Use this button when the department code has been set. If this button is pressed after copying, the next user cannot use the copier function without keying in the registered department code. See the User Functions Guide for the department management.

12. [ENERGY SAVER] button

Use this button when you want to shut down the equipment or when you want the equipment to enter into the energy saving mode. When you press this button, the menu for the energy saving mode appears. Press the [SLEEP] button on this menu to enter into the energy saving mode and press the [SHUTDOWN] button to shut down the equipment.

13. [FUNCTION CLEAR] button

When this button is pressed, all selected functions are cleared and returned to the default settings.

14. [STOP] button

Use this button to stop any scanning and copying operations in progress.

15. [START] button

Use this button to start copying, scanning and FAX operations.

16. [CLEAR] button

Use this button to correct numbers keyed in, such as the copy quantity.

17. ERROR lamp

This lamp lights when an error occurs and the equipment needs some actions to be taken.

18. PRINT DATA lamp

This lamp lights when print data are being received.

19. [MONITOR/PAUSE] button

Use this button for on-hook transmission or pause entry. Pressing this button in the middle of direct entry will display “-” as a “pause” on the screen.

20. Digital keys

Use these keys to enter the telephone and Fax numbers, ID numbers and password.

21. Touch panel

Use this panel for the various settings of each function of the copier, scanner and FAX. This panel also indicates the status of the equipment, such as when you run out of paper or there is a paper jam.

22. [TEMPLATE] button

Use this button to store and recall frequently used copy, scan, and FAX settings.

23. [USER FUNCTIONS] button

Use this button for paper size or media type setting of drawers, and registration of the copy, scan and FAX settings (including a default setting change.) See the User Functions Guide for the functions enabled by this button.

Touch panel

1

When you press the [FAX] button on the control panel, the functions currently selected or used and the status of the equipment are displayed on the touch panel.

When a graphic symbol indicating an erroneous status such as a paper jam is blinking, see Chapter 9 "BLINKING GRAPHIC SYMBOLS" in the Operator's Manual for Basic Function to correct the error.

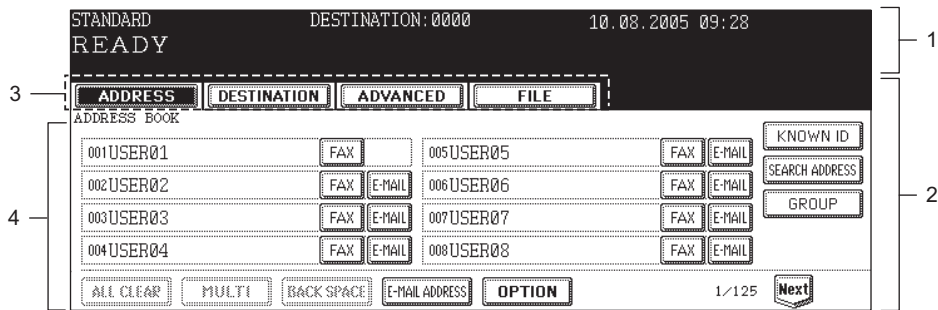

- | | |
|----------------------|--------------------------|
| 1. Message area | 3. Index buttons |
| 2. Touch-button area | 4. Function setting area |

Message area

The following information is shown here:

- Equipment status
- Operation instruction
- Cautionary messages
- Transmission resolution
- Number of destinations set
- Date and time

Touch-button area

The function fields shown here are selectable with a direct touch on the panel. Press the desired button lightly with your finger.

- Index buttons
Press these buttons to switch each menu for the address book, destination confirmation, advanced functions, and file saving.
- Function setting area
This area is to select and set various functions.

Clearing and canceling function selected

When you press the selected button (highlighted or shaded) again, the function selected with this button is cleared. To quit (cancel) the setting, press the [CANCEL] button at the bottom of the touch panel (or the [ALL CLEAR] button on the address book menu).

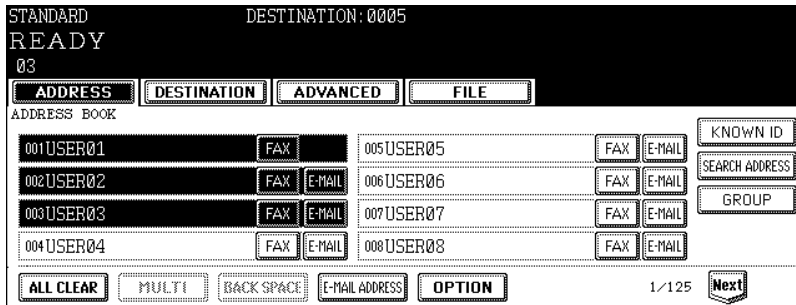

Tip

Buttons on the touch panel which are grayed out denote that functions for these buttons are not selectable.

Connecting cables

Be sure that the power of the equipment is turned OFF before connecting the cables.

1

Note

Do not connect this equipment and a telephone to a telephone connector in parallel.

e-STUDIO520/600/720/850

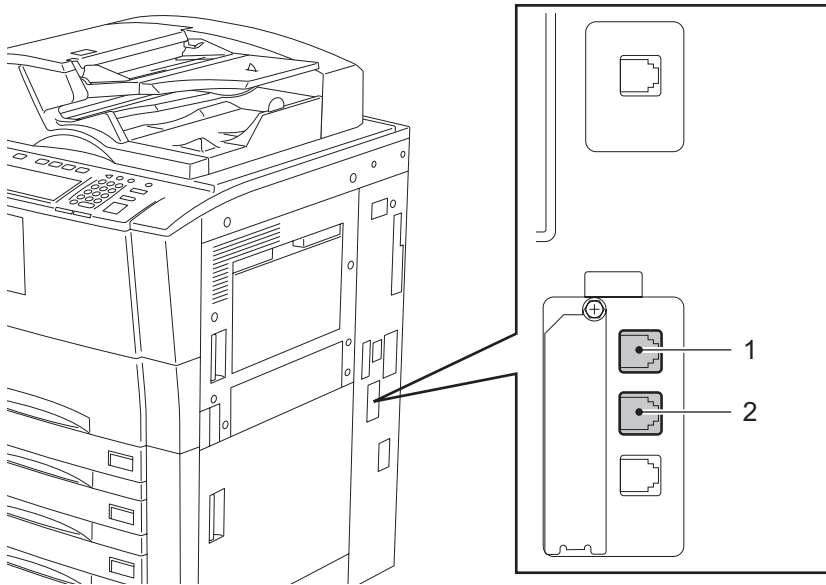

- 1. LINE Connect a telephone line.
- 2. TEL Connect an external telephone (for a remote reception)
- * An optional external telephone handset is not available for this version.

2. SENDING A FAX

1. Transmission Mode.....	22
2. Preparation for Transmission.....	24
3. About Originals.....	25
• Original size/Original scanning range.....	25
• Setting originals.....	26
4. Setting the Transmission Conditions.....	29
• Variety of optional functions.....	29
• Setting the transmission conditions.....	31
• Sending different width originals.....	33
• Setting the scanning conditions for each page.....	35
5. Specifying the Remote Fax.....	37
• Direct entry with digital keys.....	37
• Address book entry.....	38
• Group entry.....	39
• Searching by ID number.....	40
• Searching by address (Search address).....	42
• Searching address using LDAP server.....	45
• Multi-address transmission.....	47
• Confirming the destinations.....	48
6. Sending Originals.....	49
• Direct transmission.....	49
• Memory transmission.....	51
• Other transmissions.....	53
• Sending a Tone.....	55

1. Transmission Mode

2

- **Memory Transmission**

The original is scanned into memory and automatically starts to be sent once a connection has been made. Using this mode, you can send the same original to 2 or more remote Faxes (multi-address transmission).

- **Direct Transmission**

The remote Fax is dialed immediately, and the original will be sent as it is being scanned. This mode is useful if you want to confirm connection to the remote Fax or when you want to send an urgent Fax document. Originals are not stored in memory, and you can only specify one remote Fax at a time.

- **Direct Entry with digital keys**

You can dial the telephone number of the remote Fax directly using the digital keys

- **Address Book Entry**

You can specify a remote Fax that has been registered into the address book.

- **Multi-address Transmission**

You can send the same original to 2 or more remote Faxes in a single operation.

- **Group Entry**

Originals are sent to the destinations that have already been specified as a group.

- **Recovery Transmission**

A document is held in the memory after the initially specified number of redial attempts have failed. You can retransmit the documents held in memory by touching the screen.

- **On-hook Transmission**

You can make a telephone call and then send the originals without picking up the handset of the external telephone. When the line is connected to the remote Fax and a dial tone (short high-pitched tone) is heard, press the [START] button to send the original. You can also use keypad (digital keys) dialing and address dialing.

- **Off-hook Transmission**

* Only available if an external telephone is attached.

Pick up the external telephone, make a telephone call and then send the originals. When the line is connected to the remote Fax and a response tone (short high-pitched tone) is heard, press the [START] button to send the original. You can also use keypad (digital keys) dialing and address dialing.

- **Priority Transmission**

You can send a priority transmission and interrupt the current communication. This function allows you to interrupt the current communication and send the Priority Transmission. Transmission is resumed after completing the current communication.

- **Polling Transmission**

You can store originals in memory, and wait for a request from a remote Fax to send the originals. When the request arrives, the originals are automatically sent to the remote Fax that sent the request. The remote Fax can receive originals at any convenient time. You can also inhibit remote Faxes which do not have the corresponding password to receive the originals by appending the password to the document.

- **Mailbox Transmission**

You can have confidential, bulletin board and multi-address relay mail communication, transmission box with remote Faxes that support the ITU-T Mailbox functions.

- **Delayed Communications**

You can send the original to a specified remote Fax at a specified time. This mode is useful when you are making use of night-time discounts or sending originals overseas.

- **Chain Dial Communication**

When using the Fax communication network, you can combine 2 or more dialing operations (by address book and direct entry), input and send information such as service codes one after another.

- **Batch Transmission**

The system will automatically send 2 or more reserved jobs to one remote Fax at a time.

This function can reduce the communication cost by sending multiple originals to the same destination at one time.

This operation is automatically applied when more than one original is sent to one remote Fax with the same transmission functions specified for each reserved TX job.

* When the use of the equipment is managed under the department management or the user management, the batch transmission can be performed only in the same department and user.

- **Redialing**

If the remote Fax is busy by using the Memory TX etc., this system will automatically redial the remote Fax number. The default of the redialing intervals and counter is different for each country/region. It can be changed by the service technician.

2. Preparation for Transmission

Switching to the Fax mode

1 Press the [FAX] button on the control panel to select the Fax function.

- Be sure to switch over to the Fax mode before carrying out Fax operations.
- If you leave the equipment for about 45 seconds, it automatically returns to the copy mode.
- You can also switch to the Fax mode when the equipment is in the energy-saving mode.

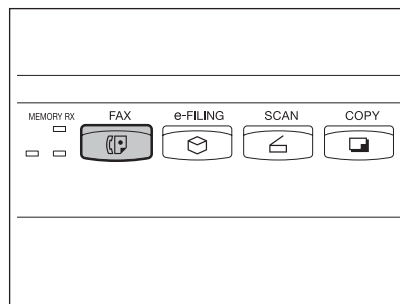

When the use of the equipment is managed under certain functions such as department management

When the use of the equipment is managed under the department management or the user management, each user needs to enter the department code, user ID, password, etc. For these operations, see the Operator's Manual for Basic Function.

3. About Originals

Original size/Original scanning range

Original size

The following table shows the size and thickness of originals that can be transmitted via this system.

Setting Position	Original Type	Original Size	Maximum Number that Can be Set	Remarks
Original Glass	Sheets Three-dimensional objects Books	Letter format (North American version): LD, LG, LT, LT-R, ST, ST-R, COMP A/B format (European version): A3, A4, A4-R, A5, A5-R, B4, B5, B5-R, FOLIO	-	Do not place any heavy object (8.8 lb. or 4 kg or over) on the glass
Reversing Automatic Document Feeder	Plain paper, original with filing holes (2-, 3- and 4-holes): 13.3 - 34 lb. 50 - 127 g/m ² (1-sided Original) 13.3 - 28 lb. 50 - 105 g/m ² (2-sided original)	Letter format (North American version): LD, LG, LT, LT-R, ST-R, COMP A/B format (European version): A3, A4, A4-R, A5-R, B4, B5, B5-R, FOLIO * ST/A5 is not available	100 originals (13.3 - 22 lb. 50 - 80 g/m ²) or stacked height of originals 16 mm or less	Some of the originals on the left may not be used depending on paper quality.

2

Original scanning range

As shown in the figures below, even if the original that you are sending contains information in the shaded section, this information is not printed at the remote Fax.

- LD, LG, LT-R, ST-R, COMP, A3, A4-R, A5-R, B4, B5-R, FOLIO
- LT, ST, A4, B5

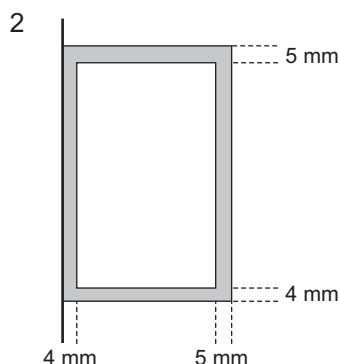
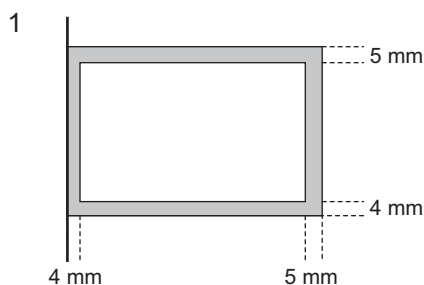

Tip

ST-R, B5-R or A5-R originals are automatically rotated and sent as ST, B5 or A5-sized originals. LT original is automatically rotated and sent as LT-R-sized original.

Setting originals

When setting originals on the glass

Originals are sent in the order they are placed on the original glass in both memory TX and direct TX modes.

2

1 Raise the Reversing Automatic Document Feeder, and place the original A with its face down on the glass.

- Raise it 60 degrees or more to detect the original.

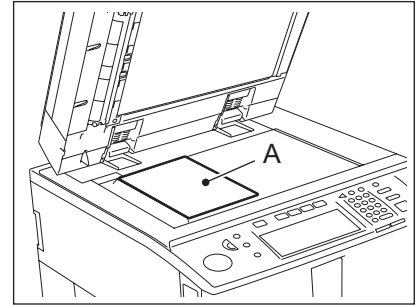

2 Align the original against the left inner corner of the glass.

- Different size originals can also be sent in one transmission.
- When LD, LG, LT-R, ST, COMP, A3, A4-R, A5, B4, B5 or FOLIO originals are placed as shown in the figure on the right, the pre-entered sender information is printed in the shaded position shown B in the figure and sent to the remote Fax.
- Entering the sender information (☞ P.150 "2.Registering the Terminal ID")
- When transmitting non-standard-sized originals, best results are obtained by placing the originals horizontally on the glass.

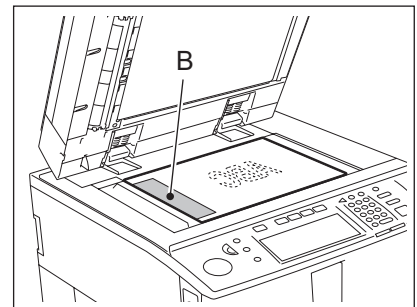

- When LT, ST-R, A4, A5-R or B5-R originals are placed as shown in the figure on the right, the pre-entered sender information is printed in the shaded position shown C in the figure and sent to the remote Fax.

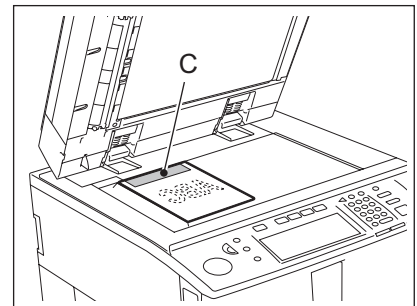

3 Lower the Reversing Automatic Document Feeder slowly.

Precautions for using the Reversing Automatic Document Feeder

Do not use the following 1 to 8 type originals as they may misfeed or become damaged:

- 1: Badly wrinkled or folded originals; in particular, originals whose leading edge is curled may fail to be correctly fed.
- 2: Originals with carbon paper
- 3: Taped, pasted or clipped (cut out) originals
- 4: Clipped or stapled originals
- 5: Originals with holes or tears
- 6: Damp originals
- 7: OHP film originals
- 8: Others: tracing paper, permeable paper, coating paper (coating with wax, etc.)

Also, the following 9 to 10 type originals should be handled carefully:

- 9: Multiple originals, when pinched between 2 fingers, cannot be moved, or originals which are surface treated may fail to be separate properly.
- 10: Folded or curled originals should be smoothed out before being used.

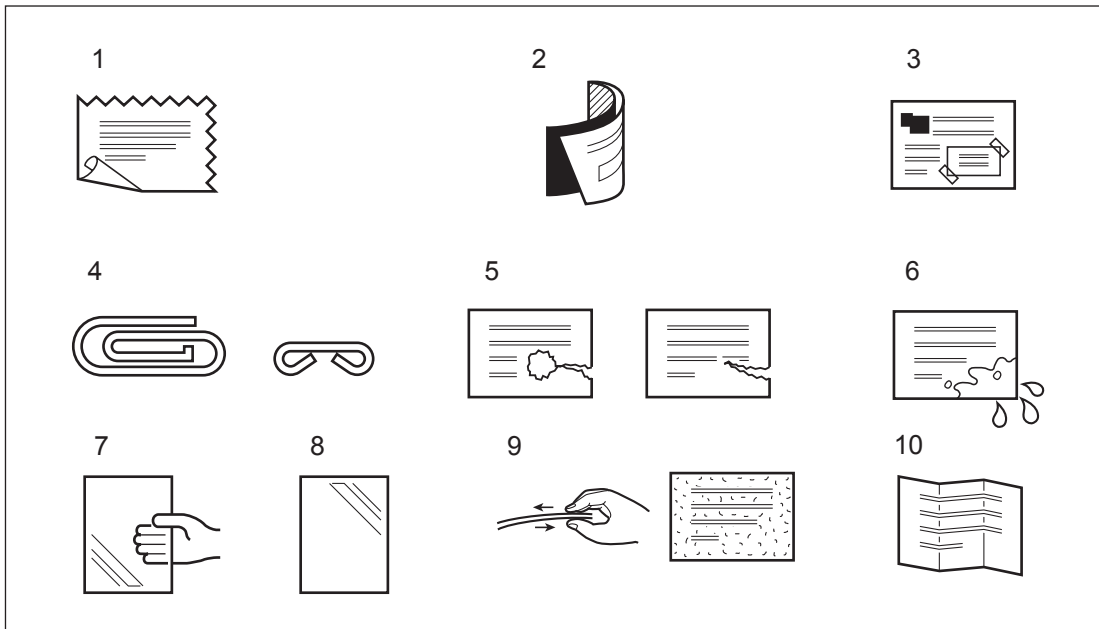

When using the Reversing Automatic Document Feeder

When the originals are placed on the Reversing Automatic Document Feeder, the uppermost page is the first to be scanned and sent.

2

1 After aligning the edges of originals, place them with their face up and slide the guides to the width of the originals.

- LT/A4 size originals are rotated 90 degrees so that they are sent as LT-R/A4-R originals.
- If a mixture of LD and LT, A3 and A4, or B4 and B5 originals are placed, they are sent in their original sizes.
- To set the originals with different width, see [P.33](#) "Sending different width originals".

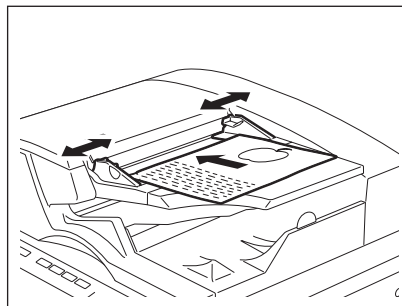

- When LD, LG, LT-R, COMP, A3 and B4, A4-R, B5 originals are placed as shown in the figure on the right, the pre-entered sender information is printed in the shaded position shown A in the figure and sent to the remote Fax.
- Entering the sender information ([P.150](#) "2.Registering the Terminal ID")

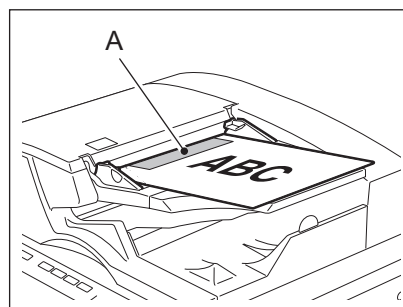

- When LT, ST-R, A4, A5-R or B5-R originals are placed as shown in the figure on the right, the pre-entered sender information is printed in the shaded position shown B in the figure and sent to the remote Fax.

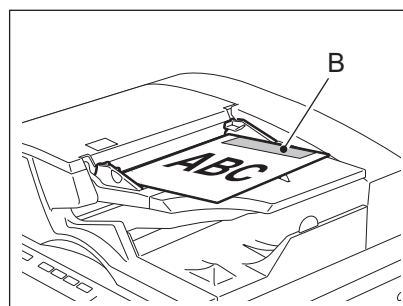

4. Setting the Transmission Conditions

Variety of optional functions

Originals can be sent using different transmission conditions (resolution, original mode, exposure, transmission mode, original size, ECM, quality TX, SUB/SEP, SID/PWD, subject and body). Settings for the subject and body are available only when you are using the Internet Fax function. If you change the transmission conditions, the new settings are valid for one transmission only. They return to the default settings after the transmission. The following describes the settings of each item.

- **Resolution:**

Set the resolution before you scan the original to be sent.

STANDARD: Original with regular size text

FINE: Original with small size text and fine illustrations

U-FINE: Original with ultra-fine illustrations

* If the remote Fax cannot receive originals with the same resolution, the resolution of the sent original is automatically converted and sent.

The finer the resolution is, the longer it takes to send an original.

- **Original Mode:**

Set the original mode before you scan the original to be sent.

TEXT, TEXT/PHOTO, PHOTO

* Transmission time may be longer than usual when the TEXT/PHOTO mode or PHOTO mode is selected.

- **Exposure:**

Set the image density according to the contrast of the original to be sent.

AUTO, MANUAL (11 variations)

* In the automatic exposure mode, the equipment automatically judges the contrast of the original, and selects the ideal contrast.

In the manual exposure mode, you can adjust the contrast manually with 11 variations.

- **Transmission Type:**

Set the transmission type.

MEMORY TX: Send the original after it is scanned into memory.

DIRECT TX: Send the original directly as it is being scanned.

- **Original Size:**

Set the scan size of the original to be sent.

AUTO:

The size of the original is automatically determined before it is scanned.

SPECIFIED SIZE:

The original is scanned at the preset size regardless of its actual size.

Use this mode when you are using non-standard size paper or you want to limit the area of the original to be sent.

DIFFERENT WIDTH:

Set this function to send the originals with different width at a time using Reversing Automatic Document Feeder. (P.33 "Sending different width originals")

- **ECM (Error Correction Mode):**

ECM (Error Correction Mode) is an internationally standardized communication mode that automatically corrects errors that occur during Fax transmissions. Even when the transmitted data has been affected by noise during communication, this mode allows good communication without image distortion by automatically resending the part that has been affected.

ON, OFF

* Both the transmitter and the receiver must have the ECM function to make ECM communication available. When affected by noise during communication, communication time takes longer than usual.

- **Quality TX:**

Set whether or not to specify Quality TX. This function makes the communication less affected by line condition when transmitting document to overseas. When this mode is set to "ON", originals are sent at a slower speed than normal.

ON, OFF

- **SUB/SEP, SID/PWD:**

Input the sub-address when the remote Fax you are communicating with needs a sub-address. Sub-address is divided into the following categories.

SUB (sub-address):	Entering information
SEP (selective polling address):	Retrieving information
SID (sender identification):	Password for SUB
PWD (password):	Password for SEP

* Up to 20 digits of information can be stored for each of these sub-addresses.

When you send documents, you can specify a sub-address or password compatible with ITU-T (International Telecommunications Union Telecommunications) standards.

* To use this function, the remote Fax must be capable of setting an ITU-T compatible sub-address or password. For details, contact your nearest Toshiba Service Center.

- **Subject, Body:**

Subject and body can be added when using the Internet Fax function.

* When originals are placed on the original glass, you can change the following scanning conditions for each page. (📖 P.35 "Setting the scanning conditions for each page")

Resolution Original mode

Exposure Original size

* Changing the default settings (HOME POSITION) when sending originals. (📖 P.148 "1.Setting the Initial Transmission Mode")

Setting the transmission conditions

1 Place the original(s).

- P.26 “Setting originals”

2 Press the [FAX] button on the control panel.

3 Press the [ADDRESS] button to enter the address menu, and then press the [OPTION] button.

STANDARD DESTINATION: 0000
READY

ADDRESS DESTINATION ADVANCED FILE

ADDRESS BOOK

001 USER01	FAX	005 USER05	FAX	E-MAIL	KNOWN ID
002 USER02	FAX	E-MAIL	006 USER06	FAX	E-MAIL
003 USER03	FAX	E-MAIL	007 USER07	FAX	E-MAIL
004 USER04	FAX	E-MAIL	008 USER08	FAX	E-MAIL

ALL CLEAR MULTI BACK SPACE E-MAIL ADDRESS OPTION 1/125 Next

4 Press the desired buttons to set the transmission conditions, and then press the [ENTER] button.

- Press the [Prev] or [Next] button to switch the screens.

STANDARD DESTINATION: 0000
READY

ADDRESS DESTINATION ADVANCED FILE

RESOLUTION ORIGINAL

MODE

EXPOSURE

TX TYPE

RESET CANCEL ENTER Next

STANDARD DESTINATION: 0000
READY

ADDRESS DESTINATION ADVANCED FILE

ECM

QUALITY TX

SUB/SEP

SID/PWD

SUBJECT Scanned from MEP-00C91875

BODY

RESET CANCEL ENTER Prev

5 Specify the remote Fax and press the [START] button.

STANDARD DESTINATION: 0001
READY
24

ADDRESS DESTINATION ADVANCED FILE

ADDRESS BOOK

001 USER01	FAX	005 USER05	FAX	E-MAIL	KNOWN ID
002 USER02	FAX	E-MAIL	006 USER06	FAX	E-MAIL
003 USER03	FAX	E-MAIL	007 USER07	FAX	E-MAIL
004 USER04	FAX	E-MAIL	008 USER08	FAX	E-MAIL

SEARCH ADDRESS
GROUP

ALL CLEAR MULTI BACK SPACE E-MAIL ADDRESS OPTION 1/125 Next

2

Sending different width originals

When you select the [DIFFERENT WIDTH] button in the “ORIGINAL” of the transmission condition, the originals with different width can be sent at a time using Reversing Automatic Document Feeder. Available combinations of the original size are as follows. (Not available for the combination of LT format and A/B format)

LT format: LD, LT, COMP, LG, LT-R

A/B format: A3, A4, B4, B5, A4-R, FOLIO

- 1 Adjust the tray guide to the widest original size, and then align the original against the front side.

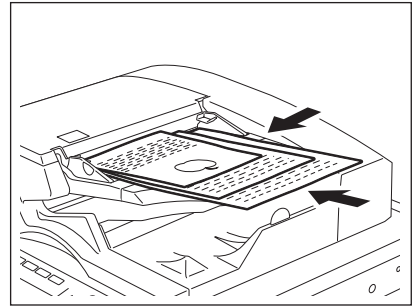

- 2 Press the [FAX] button on the control panel.
- 3 Press the [ADDRESS] button to enter the address menu, and then press the [OPTION] button.

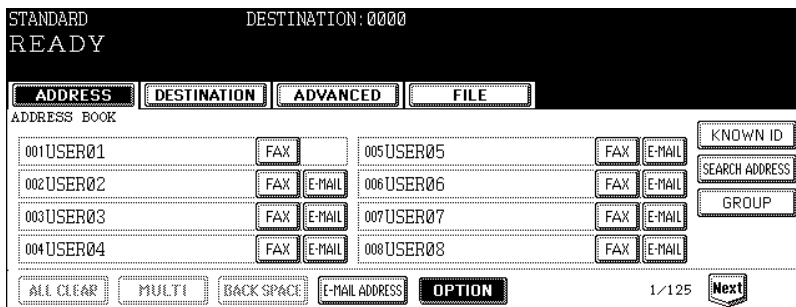

- 4 Press the [DIFFERENT WIDTH] button. And press the [ENTER] button to complete the setting.

- Set the other transmission condition as required. (P.31 “Setting the transmission conditions”)

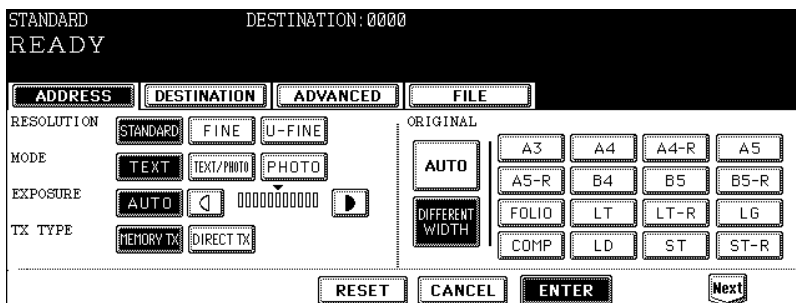

5 Specify the remote Fax and press the [START] button.

STANDARD DESTINATION: 0001
READY
24

ADDRESS DESTINATION ADVANCED FILE

ADDRESS BOOK

001 USER01	FAX	005 USER05	FAX	E-MAIL	KNOWN ID
002 USER02	FAX	E-MAIL	006 USER06	FAX	E-MAIL
003 USER03	FAX	E-MAIL	007 USER07	FAX	E-MAIL
004 USER04	FAX	E-MAIL	008 USER08	FAX	E-MAIL

SEARCH ADDRESS
GROUP

ALL CLEAR MULTI BACK SPACE E-MAIL ADDRESS OPTION 1/125 Next

2

Setting the scanning conditions for each page

When you want to send multi-page originals by placing them on the original glass, you can change the following scanning conditions for each page:

Resolution Exposure
Original mode Original size

This function is convenient for newspapers and books can be placed on the original glass and sent.

2

1 Place the original on the glass.

- [P.26](#) "When setting originals on the glass"

2 Press the [FAX] button on the control panel.

3 Press the [OPTION] button and set the transmission conditions. And press the [ENTER] button to complete the setting.

- [P.29](#) "4.Setting the Transmission Conditions"

4 Specify the remote Fax.

- Specifying by digital keys ([P.37](#) "Direct entry with digital keys")
- Specifying by address book ([P.38](#) "Address book entry")
- Specifying by group ([P.39](#) "Group entry")
- Specifying by multi-address transmission ([P.47](#) "Multi-address transmission")

5 Press the [START] button.

- The first original is scanned.

6 Place the next original.

7 Select the [OPTION] button and set the transmission conditions for the second original as required. And press the [ENTER] button to complete the setting.

- The changeable scanning conditions for each page are the "RESOLUTION", "MODE", "EXPOSURE" and "ORIGINAL".

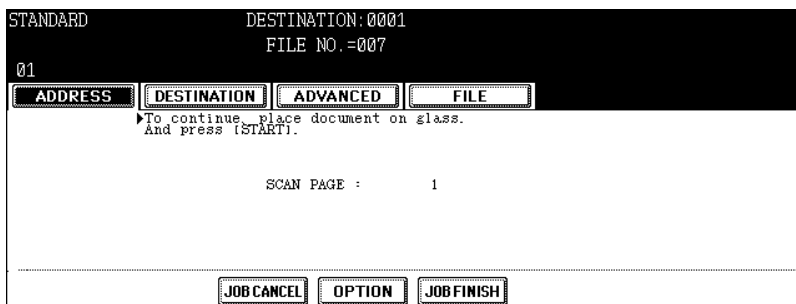

8 Press the [START] button.

- The second original is scanned.
- If there is another original to be scanned, repeat steps 5 through 7.

Tip

Be sure to carry out the operations within 45 seconds after the "To continue place document on glass, and press START" appears. If the equipment is inactive for 45 seconds, the scanned original is sent.

9 When finished scanning of the last page, press the [JOB FINISH] button.

- The originals are sent.

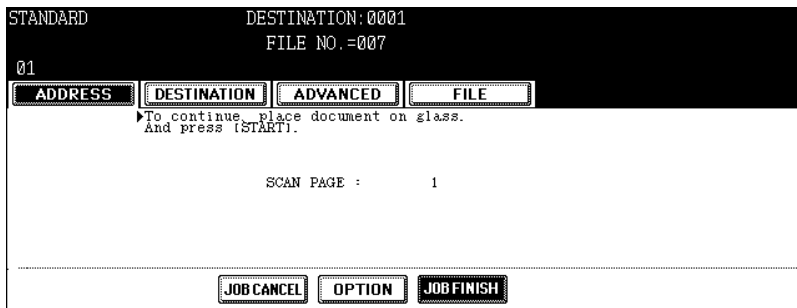

5. Specifying the Remote Fax

Direct entry with digital keys

Direct entry is the method for specifying remote Fax numbers using the digital keys.

- 1 Place the original(s).**
 - P.26 “Setting originals”
- 2 Press the [FAX] button on the control panel.**
- 3 Key in the remote Fax number.**

2

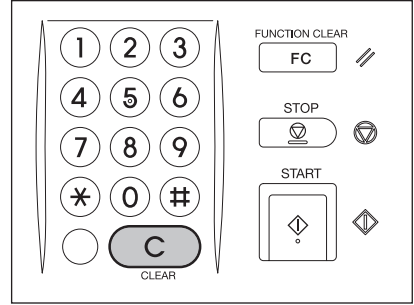

- 4 If you make a mistake, press the [CLEAR] button on the control panel or the [BACK SPACE] button in the address menu and correct the mistake.**

- [CLEAR] button: Press this button to clear all values you have entered.
- [BACK SPACE] button: Press this button to delete each value you have.

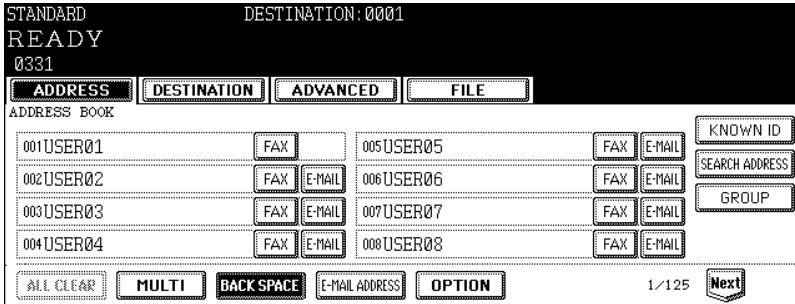

Tip

When you are dialing to an outside line via a PBX, there may be a pause before the connection is made, causing a transmission error. To avoid this error, press the [MONITOR/PAUSE] button after the number that designates an outside line to enter a pause. This automatically enters a three-second pause before the remote Fax number is dialed, which reduces transmission errors. (The mark “-” is displayed as a “pause” on the screen.)

- 5 Press the [START] button.**

Address book entry

Address book entry is the method for specifying remote Fax numbers by pressing the remote Fax buttons which have previously been registered. It is convenient if frequently used destinations are registered in the address book.

- Registering the address book, see the [User Functions Guide].

2

1 Place the original(s).

- P.26 “Setting originals”

2 Press the [FAX] button on the control panel.

3 Press the [ADDRESS] button to enter the address menu.

- Each screen displays 8 destinations. To view destinations not displayed on the screen, press the [Prev] or [Next] button to switch the screens.

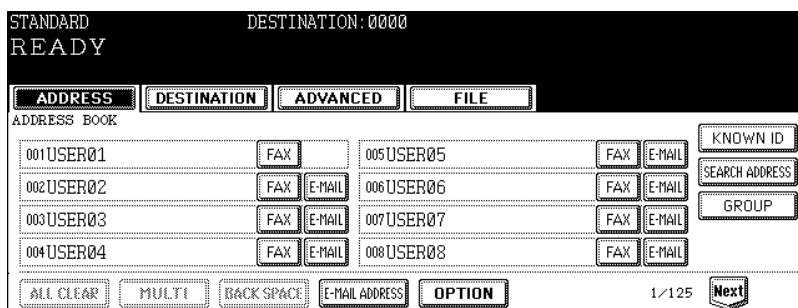

4 Press the button designating the remote Fax to which you wish to send your transmission.

- You can search for remote Faxes by ID number and by address.
 P.40 “Searching by ID number”
 P.42 “Searching by address (Search address)”

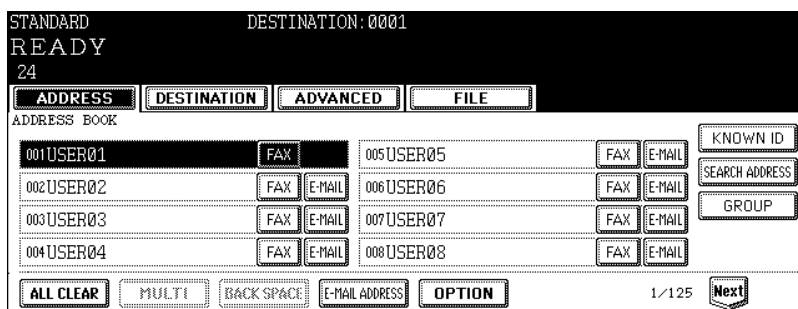

5 Press the [START] button.

Group entry

Group entry is the method of specifying remote Fax numbers by pressing the group button which has previously been entered. It is convenient if frequently used multiple destinations are entered into a group.

- Creating Groups, see the [User Functions Guide].

1 Place the original(s).

-  P.26 “Setting originals”

2 Press the [FAX] button on the control panel.

3 Press the [ADDRESS] button to enter the address menu, then Press the [GROUP] button.

- Each screen displays 8 destinations. To view destinations not displayed on the screen, press the [Prev] or [Next] button to switch the screens.

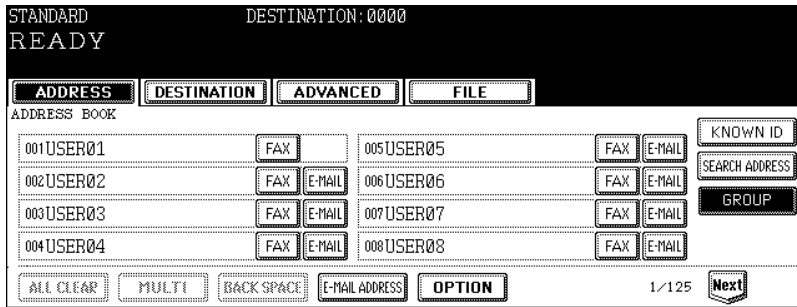

STANDARD DESTINATION: 0000
READY



ADDRESS DESTINATION ADVANCED FILE

ADDRESS BOOK

001USER01	FAX	005USER05	FAX	E-MAIL	KNOWN ID	
002USER02	FAX	E-MAIL	006USER06	FAX	E-MAIL	SEARCH ADDRESS
003USER03	FAX	E-MAIL	007USER07	FAX	E-MAIL	GROUP
004USER04	FAX	E-MAIL	008USER08	FAX	E-MAIL	

ALL CLEAR MULTI BACK SPACE E-MAIL ADDRESS OPTION 1/125 Next

4 Press the remote Fax group to send originals. If you want to see the specified group members, press the [CONTENTS] button.

- You can search for groups by ID number and by group.
( P.40 “Searching by ID number”)
( P.42 “Searching by address (Search address)”)

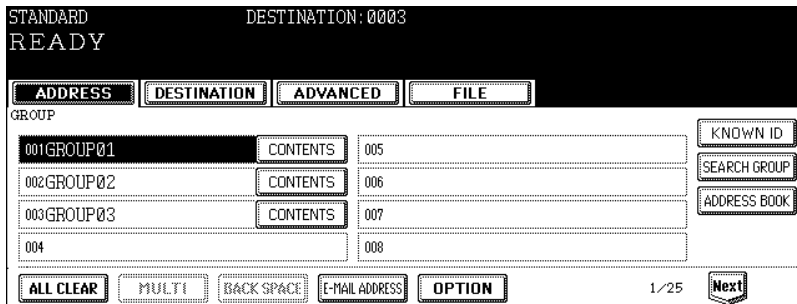

STANDARD DESTINATION: 0003
READY

ADDRESS DESTINATION ADVANCED FILE

GROUP

001GROUP01	CONTENTS	005	KNOWN ID
002GROUP02	CONTENTS	006	SEARCH GROUP
003GROUP03	CONTENTS	007	ADDRESS BOOK
004		008	

ALL CLEAR MULTI BACK SPACE E-MAIL ADDRESS OPTION 1/25 Next

Tip

The Remote Faxes in the group can be confirmed in the group number information. See the [User Functions Guide].

5 Press the [START] button.

Searching by ID number

When selecting the remote Faxes registered in the address and group by searching by the ID number immediately displays the screen including the searched-for ID number.

1 Place the original(s).

- P.26 "Setting originals"

2 Press the [FAX] button on the control panel.

3 Press the [ADDRESS] button to enter the address menu, then the [KNOWN ID] button.

STANDARD DESTINATION: 0000
READY

ADDRESS DESTINATION ADVANCED FILE

ADDRESS BOOK

001USER01	FAX	005USER05	FAX	E-MAIL	KNOWN ID SEARCH ADDRESS GROUP	
002USER02	FAX	E-MAIL	006USER06	FAX		E-MAIL
003USER03	FAX	E-MAIL	007USER07	FAX		E-MAIL
004USER04	FAX	E-MAIL	008USER08	FAX		E-MAIL

ALL CLEAR MULTI BACK SPACE E-MAIL ADDRESS OPTION 1/125 Next

4 Key in the desired ID number, and press the [ENTER] button.

- You can key in the number within the range of 1 to 1000.

STANDARD DESTINATION: 0000
READY

ADDRESS DESTINATION ADVANCED FILE

KNOWN ID Enter ID Number

KNOWN ID : 3

CANCEL ENTER

5 Press the button for the remote Fax that you want to send to.

- Each screen displays 8 destinations. To view destinations not displayed on the screen, press the [Prev] or [Next] button to switch the screens.

STANDARD DESTINATION: 0001
READY
03

ADDRESS BOOK

ADDRESS	DESTINATION	ADVANCED	FILE
001USER01	FAX		
002USER02	FAX	E-MAIL	
003USER03	FAX	E-MAIL	
004USER04	FAX	E-MAIL	
005USER05	FAX	E-MAIL	KNOWN ID
006USER06	FAX	E-MAIL	SEARCH ADDRESS
007USER07	FAX	E-MAIL	GROUP
008USER08	FAX	E-MAIL	

ALL CLEAR MULTI BACK SPACE E-MAIL ADDRESS OPTION 1/125 Next

Tips

- To continue searching by ID number, press the [KNOWN ID] button.
- To continue searching by address (see P.42 "Searching by address (Search address)"), press the [SEARCH ADDRESS] button.

6 Press the [START] button.

Searching by address (Search address)

When selecting the remote Faxes registered in the address book and group, pressing a letter button leads to display the remote Faxes whose names start with the letter and/or numbers, which makes it easy to choose the desired remote Faxes.

1 Place the original(s).

- P.26 “Setting originals”

2 Press the [FAX] button on the control panel.

3 Press the [ADDRESS] button to enter the address menu. Press the [SEARCH ADDRESS] button.

STANDARD DESTINATION: 0000
READY

ADDRESS DESTINATION ADVANCED FILE

ADDRESS BOOK

001 USER01	FAX	005 USER05	FAX	E-MAIL	KNOWN ID SEARCH ADDRESS GROUP	
002 USER02	FAX	E-MAIL	006 USER06	FAX		E-MAIL
003 USER03	FAX	E-MAIL	007 USER07	FAX		E-MAIL
004 USER04	FAX	E-MAIL	008 USER08	FAX		E-MAIL

ALL CLEAR MULTI BACK SPACE E-MAIL ADDRESS OPTION 1/125 Next

4 Press the button you want to search.

DESTINATION: 0000

ADDRESS DESTINATION ADVANCED FILE

ADDRESS SEARCH

FIRST NAME	CORP.
LAST NAME	DEPT.
FAX NO.	KEYWORD
E-MAIL	

DIR SERVICE CLEAR CANCEL SEARCH

5 Enter the ideal button or number, and then press the [ENTER] button.

USER03_

A numeric keypad interface with the following layout:

- Row 1: | | " | # | \$ | % | & | ' | (|) | = | ~ | | | \ | { | } | Back Space
- Row 2: * | < | > | ? | _ | - | ^ | @ | + | | | ; | : | / | \ | ← | →
- Row 3: Q | W | E | R | T | Y | U | I | O | P
- Row 4: A | S | D | F | G | H | J | K | L
- Row 5: Z | X | C | V | B | N | M | , | . | Shift | Caps Lock
- Bottom row: Space | CANCEL | ENTER | Next

2

03_

Enter the fax/tel number

Back Space

← | →

CANCEL | ENTER

6 Press the [SEARCH] button.

DESTINATION: 0000

ADDRESS | DESTINATION | ADVANCED | FILE

ADDRESS SEARCH

FIRST NAME	USER03	CORP.	
LAST NAME		DEPT.	
FAX NO.	03	KEYWORD	
E-MAIL			

DIR SERVICE | CLEAR | CANCEL | SEARCH

7 Press the button for the remote Fax that you want to send to, and then press the [ENTER] button.

- If the remote FAX to be selected is one, the direct transmission (On-hook Transmission) can be performed.
- Each screen displays 8 destinations. To view destinations not displayed on the screen, press the [Prev] or [Next] button to switch the screens.

Tips

- To continue searching by the address, press the [SEARCH ADDRESS] button.
- To continue searching by the ID number (P.40 "Searching by ID number"), press the [KNOWN ID] button.

DESTINATION: 0001

ADDRESS DESTINATION ADVANCED FILE

ADDRESS SEARCH

003USER03	FAX	E-MAIL		

ENTER 1/1

8 To perform the memory transmission, press the [START] button to complete the operation. To perform the direct transmission, follow the procedure from step 9.

9 To perform the On-hook transmission, press the [MONITOR/PAUSE] button and the [DIAL] button.

Press [DI&L] button,
to call selected address.

ADDRESS BOOK

001USER01	FAX		005USER05	FAX	E-MAIL	KNOWN ID
002USER02	FAX	E-MAIL	006USER06	FAX	E-MAIL	SEARCH ADDRESS
003USER03	FAX	E-MAIL	007USER07	FAX	E-MAIL	GROUP
004USER04	FAX	E-MAIL	008USER08	FAX	E-MAIL	

ALL CLEAR MULTI BACK SPACE E-MAIL ADDRESS OPTION DIAL Next

10 When you hear the answer tone (short high-pitched tone) through the built-in speaker, press the [START] button.

Searching address using LDAP server

Without using the address book in this equipment, you can select the remote Faxes registered in the address book of the LDAP (Lightweight Directory Access Protocol) server via network. In this case, it is required to register the directory search name using TopAccess via network beforehand. (You can also set the default LDAP server that you want to select.) Ask your network administrator for details.

1 Place the original(s).

- P.26 “Setting originals”

2 Press the [FAX] button on the control panel.

3 Press the [ADDRESS] button to enter address menu, and then press the [SEARCH ADDRESS] button.

- If the LDAP server has already been set, go to step 6.

STANDARD DESTINATION: 0000
READY

ADDRESS DESTINATION ADVANCED FILE

ADDRESS BOOK

001USER01	FAX	005USER05	FAX	E-MAIL	KNOWN ID	
002USER02	FAX	E-MAIL	006USER06	FAX	E-MAIL	SEARCH ADDRESS
003USER03	FAX	E-MAIL	007USER07	FAX	E-MAIL	GROUP
004USER04	FAX	E-MAIL	008USER08	FAX	E-MAIL	

ALL CLEAR MULTI BACK SPACE E-MAIL ADDRESS OPTION 1/125 Next

4 Press the [DIR SERVICE] button.

DESTINATION: 0000

ADDRESS DESTINATION ADVANCED FILE

ADDRESS SEARCH

FIRST NAME		CORP.	
LAST NAME		DEPT.	
FAX NO.		KEYWORD	
E-MAIL			

DIR SERVICE CLEAR CANCEL SEARCH

5 Press the directory search name that you want to search, and then press the [ENTER] button

2

DESTINATION: 0000

ADDRESS DESTINATION ADVANCED FILE

Directory Search Name

dirserv1

dirserv2

dirserv3

CANCEL ENTER 1/1

6 Search the remote Fax, and then send it.

- Follow the procedure from step 4 in P.42 "Searching by address (Search address)".
- * Searching using the LDAP server is available for Fax number and E-mail.

Multi-address transmission

The multi-address transmission function allows you to send the same document to 2 or more remote Faxes in a single operation, which can be done by combining direct, address book and group entry. Combining with the Internet Fax function is also available. This eliminates the need of placing the original and then dialing the number for each destination.

The following shows the number of destinations that can be entered according to how the remote Fax is specified:

- By direct entry only: 400 destinations
- By address book entry only: 400 destinations
- By group entry only: 200 groups (400 destinations per a group, maximum 400 locations)
- By combining direct, address book and group entry: 400 destinations maximum
- * Multi-address transmissions must be set in the memory TX mode. (P.31 “Setting the transmission conditions”)

2

1 Place the original(s).

- P.26 “Setting originals”

2 Press the [FAX] button on the control panel.

3 Press the [OPTION] button and set the transmission conditions.

- P.29 “4.Setting the Transmission Conditions”

4 Specify the remote Fax numbers.

- To continuously enter remote Fax numbers after having specified them by means of the digital keys, press the [MULTI] button, then enter the next number. You do not need to press the [MULTI] button for the address book or the group entry.
- The selected destinations can be confirmed by selecting the [DESTINATION] button. (P.48 “Confirming the destinations”)

Tips

- To cancel the remote Fax number entered with digital keys, press the [CLEAR] button on the control panel.
- To cancel a remote Fax specified with address book or group entry, press the highlighted button for the remote Fax again. To cancel all specified remote Faxes, press the [ALL CLEAR] button.
- To cancel a remote Fax specified with direct entry, press the [DESTINATION] button to enter the destination menu, and then cancel it. (P.48 “Confirming the destinations”)

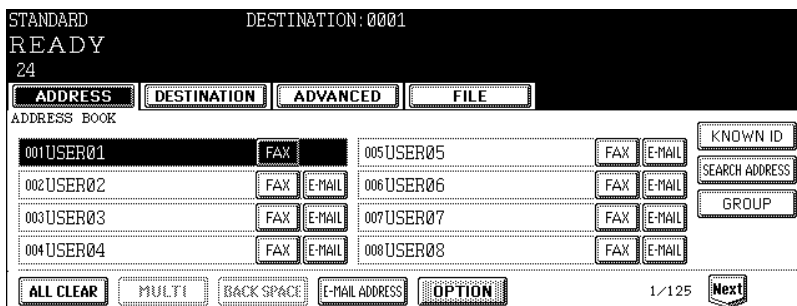

5 Specify all remote Faxes, then press the [START] button.

47

Confirming the destinations



After specifying multiple destinations by using multi-address transmitting, you can confirm the addresses in the list by pressing the [DESTINATION] button. You can also delete the addresses by pressing the [DELETE] button.

1 Press the [DESTINATION] button.

- Each screen displays 8 destinations. To view destinations which are not displayed on the screen, press the [Prev] or [Next] button to switch the screens.

DESTINATION: 0018



ADDRESS	DESTINATION	ADVANCED	FILE
DESTINATION			
USER09	FAX	USER13	FAX
USER10	FAX	USER14	FAX
USER11	FAX	USER15	FAX
USER12	FAX	USER16	FAX
DELETE			

2/3  

2 Select the destination that you wish to delete, and then press the [DELETE] button.

DESTINATION: 0018

ADDRESS	DESTINATION	ADVANCED	FILE
DESTINATION			
USER09	FAX	USER13	FAX
USER10	FAX	USER14	FAX
USER11	FAX	USER15	FAX
USER12	FAX	USER16	FAX
DELETE			

2/3  

6. Sending Originals

Direct transmission

In the direct transmission mode, the remote Fax is immediately dialed, and the originals are sent after a successful connection with the remote Fax that has been completed.

- Users can check immediately if the original has been sent to the remote Fax.
- Once scanned, the originals are not stored in the memory.
- Users can specify only one remote Fax at one time.
- After a page has been sent, the next page is scanned. It takes longer to scan all pages.
- If an original is placed on the original glass, only one page can be sent.
- * Memory transmission is set as the initial setting. Changing the initial setting to direct transmission (P.148 “1.Setting the Initial Transmission Mode”)

2

Direct transmission by optional setting

1 Place the original(s).

- P.26 “Setting originals”

2 Press the [FAX] button on the control panel.

3 Press the [ADDRESS] button to enter the address menu, and then press the [OPTION] button.

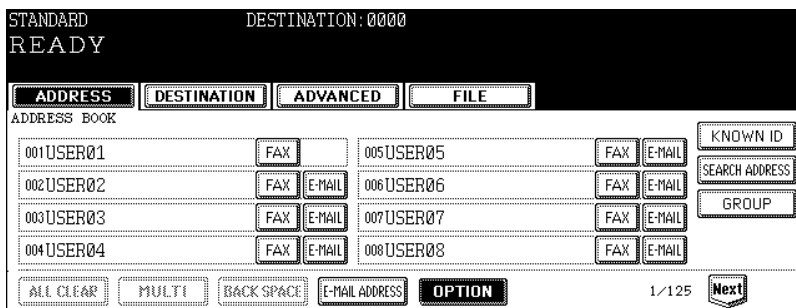

4 Press the [DIRECT TX] button, set the other transmission conditions, then press the [ENTER] button.

- P.29 “4.Setting the Transmission Conditions”

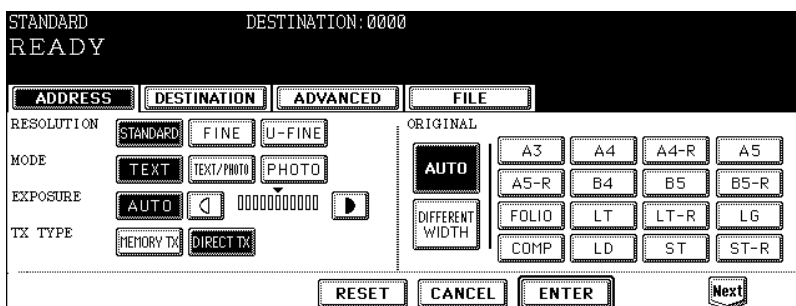

5 Specify the remote Fax.

- Specifying by digital keys (📖 P.37 "Direct entry with digital keys")
- Specifying by address book (📖 P.38 "Address book entry")

6 Press the [START] button.

- The remote Fax is dialed immediately and communication is initiated.
- Canceling the direct transmission (📖 P.76 "Canceling direct transmission (during scanning)")

2

Memory transmission

In the memory transmission mode, originals are scanned at high speed and temporarily stored in memory before transmitting.

- Up to 100 transmissions can be reserved.
- Up to 1000 pages can be stored in 1 transmission.
- You can specify two or more remote Faxes at one time.
- If the original cannot be sent (the remote Fax is busy or otherwise unavailable), the remote Fax is automatically redialed repeatedly.
- If memory becomes full midway during scanning, the message "Will you enable stored originals?" appears. Press the [YES] button to send the originals which have been scanned. Press the [NO] button to delete the scanned originals. In this case, reduce the number of originals you are sending, or try sending in the direct transmission mode. (P.49 "Direct transmission")
- If an original is placed on the original glass, the scanning conditions can be changed for each page. (P.35 "Setting the scanning conditions for each page")

2

1 Place the original(s).

- P.26 "Setting originals"

2 Press the [FAX] button on the control panel.

3 Press the [ADDRESS] button to enter the address menu, and then press the [OPTION] button.

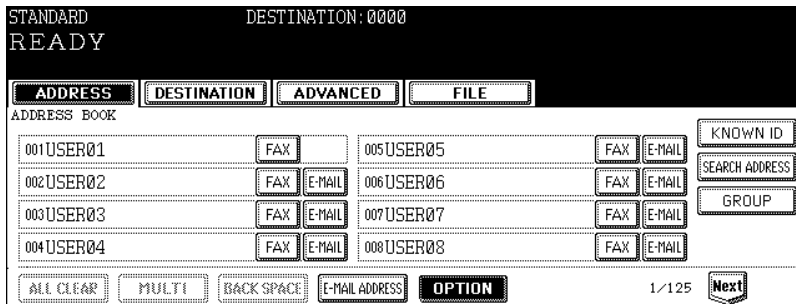

4 Press the [MEMORY TX] button, set the other transmission conditions, then press the [ENTER] button.

- P.29 "4.Setting the Transmission Conditions"

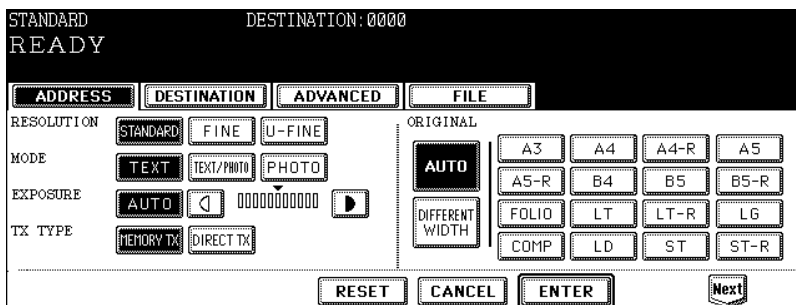

51

5 Specify the remote Fax.

- Specifying by digital keys (📖 P.37 "Direct entry with digital keys")
- Specifying by address book (📖 P.38 "Address book entry")
- Specifying by group (📖 P.39 "Group entry")
- Specifying by multi-address transmission (📖 P.47 "Multi-address transmission")

6 Press the [START] button.

- The original will be scanned and stored in memory.
- Canceling transmissions. (📖 P.72 "2.Canceling Transmissions")

Other transmissions

On-hook transmission

In this mode, you can confirm the answering tone from the remote FAX without picking up the handset of the external telephone.

When the other party receives the call as a telephone call, you can talk by picking up the handset of the external telephone.

- This operation is available when the Line 1 lamp is OFF.

1 Place the original(s).

-  P.26 "Setting originals"

2 Press the [FAX] button on the control panel.

3 Press the [OPTION] button and set the transmission conditions.



-  P.29 "4.Setting the Transmission Conditions"

4 Press the [MONITOR/PAUSE] button.

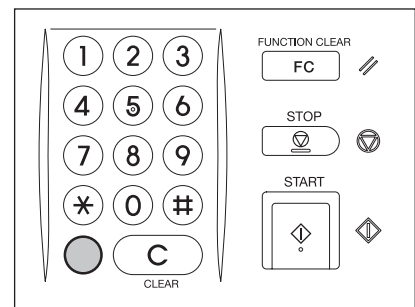
- You will hear the dial tone from the built-in speaker.
- To cancel the setting, press the [MONITOR/PAUSE] button again.



5 Specify the remote Fax.

- Specifying by digital keys ( P.37 "Direct entry with digital keys")
- Specifying by address book ( P.38 "Address book entry")

Caution

Each press of a digital key dials a number. If you make a mistake when dialing the remote Fax number, press the [MONITOR/PAUSE] button to cut the line, and then press the [MONITOR/PAUSE] button again to redial.

6 When you hear the answer tone (short high-pitched tone) through the built-in speaker indicating the connection has been made with the remote Fax, press the [START] button.

Tip

When you hear the other party's voice answering the call before pressing the [START] button, pick up the handset of the external telephone and press the [MONITOR/PAUSE] button. Then, ask him/her to operate their equipment for receiving a Fax.

Off-hook transmission

This mode is available by picking up the handset of the external telephone to dial. When the other party receives the call as a telephone call, you can talk with him/her.

- This operation is available when the Line 1 lamp is OFF.

Note

- An external telephone is required (not available for the European version).
- You can specify the remote Fax only using the external telephone.

1 Place the original(s).

-  P.26 "Setting originals"

2 Press the [FAX] button on the control panel.

3 Press the [OPTION] button and set the transmission conditions.

-  P.29 "4.Setting the Transmission Conditions"

4 Pick up the handset of the external telephone.

5 Dial the remote FAX number with the external telephone.

Caution

Each press of a digital key dials a number. If you make a mistake when dialing the remote Fax number, put the handset down to cut the line, and then pick up the handset again to redial.

6 When you hear the answer tone (short high-pitched tone) through the handset indicating the connection has been made with the remote Fax, press the [START] button.

Tip

When the other party receives the call as a telephone call, ask him/her to operate their equipment for receiving a Fax.

7 Replace the handset of the external telephone.

Sending a Tone

Tone services can be used even on pulse dial lines.

1 To receive a tone service, press the [#] button of the digital key to switch over to tone transmission.

- For details of services and how to receive Fax information services, contact your service provider.

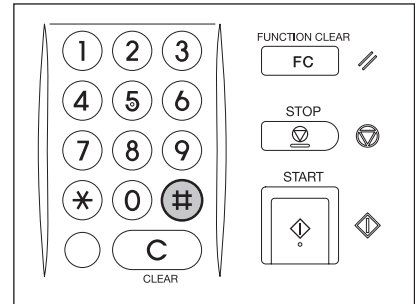

Tip

This function can be used when a user uses "Pulse Dial" line.

3. RECEIVING A FAX

1. Reception Modes	58
2. Reception Settings	59
3. Relationship between Original and Paper	62

1. Reception Modes

- **Automatic Reception**

Faxes are automatically received during the incoming call. The line is designated for use exclusively by the Fax.

- **Manual Reception**

Faxes are received when the user confirms the call on the telephone, press the [MANUAL RECEIVE] button in the advanced menu and then the [START] button.

* An external telephone is required (not available for the European version).

- **Memory Reception**

This equipment automatically stores received originals in memory if an error (e.g. a paper jam or out of paper) occurs during reception and prevents the originals from being printed. After the trouble has been cleared, printing is automatically resumed.

Memory Reception works in the following conditions.

- During copying
- During printing of received originals
- During printing of lists and reports
- When the equipment has run out of paper
- When a paper jam occurs
- When the equipment has run out of toner

- **Mailbox Reception**

You can retrieve documents from mailbox hubs (confidential, bulletin board) that support the ITU-T Mailbox functions.

- **Polling Reception**

Users request transmission from a remote Fax, and receive the original that is stored in the remote Fax's memory. There are 2 types of polling RX: individual polling RX and multi-polling RX. A password can be set.

2. Reception Settings

There are 2 reception modes: auto reception and manual reception.

- **AUTO reception**
Set this mode when the phone line is used exclusively for Faxing. The Fax automatically receives incoming originals.
- **MANUAL reception**
Set this mode when the Fax is connected to a line also used for voice telephone calls.

Setting of the reception mode

- 1 Press the [USER FUNCTIONS] button on the control panel.

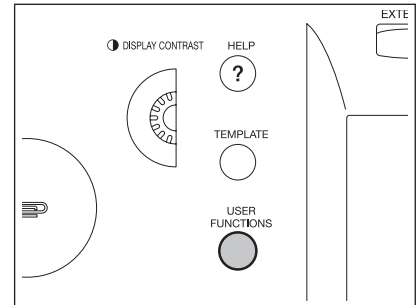

- 2 Press the [ADMIN] button and then the [PASSWORD] button.

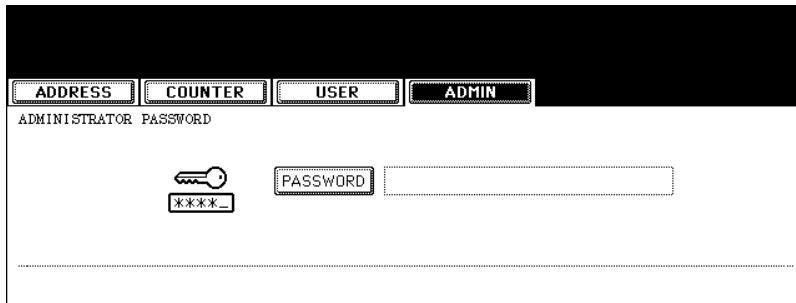

- 3 Enter the administrator password (6 to 10 digits), and then press the [ENTER] button.

- Ask your administrator for the administrator password.

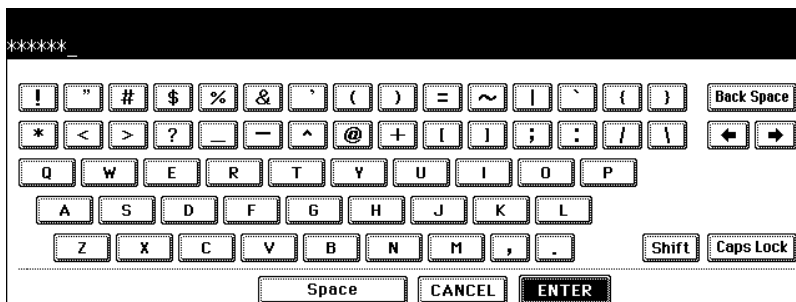

4 Press the [FAX] button.

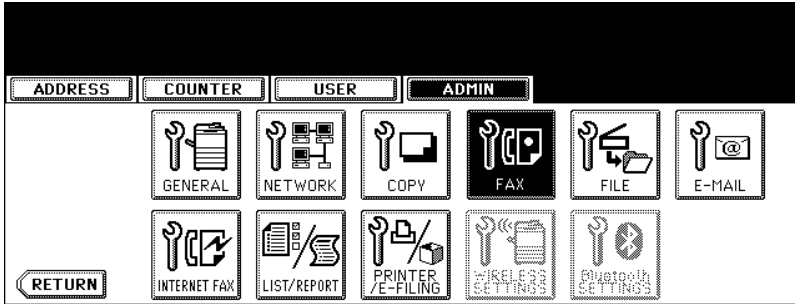

5 Press the [INITIAL SETUP] button.

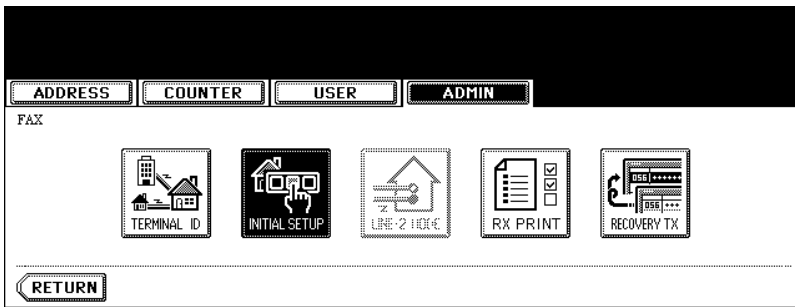

6 Press the [AUTO] or [MANUAL] button to select the reception mode, and then press the [ENTER] button.

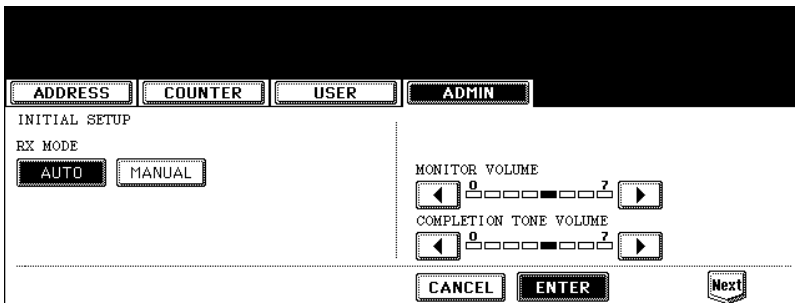

Manual reception

* An external telephone is required (not available for the European version).

1 When the bell rings, pick up the handset of the external telephone.

- If the incoming call is a telephone call, start talking with the other party.

2 If you hear a tone (Fax signal), press the [FAX] button on the control panel.

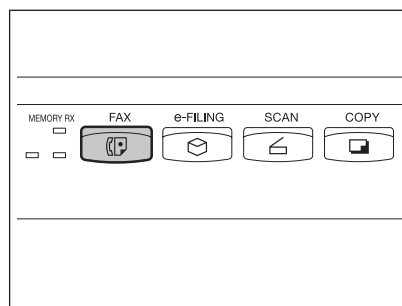

3 Press the [ADVANCED] button to enter the advanced menu, and then press the [MANUAL RECEIVE] button.

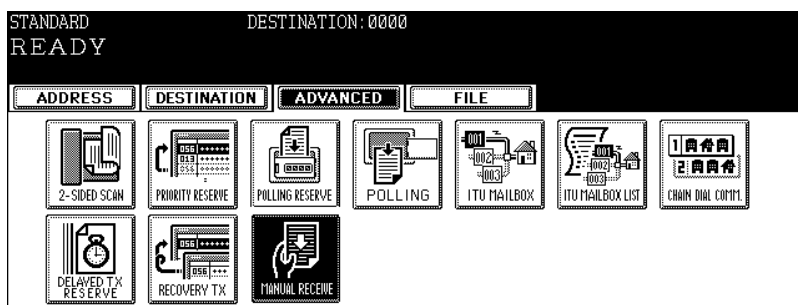

4 Make sure that "OFF HOOK RECEIVE" appears, press the [START] button and replace the handset.

3. Relationship between Original and Paper

Acceptable size of paper

Originals received by Fax can be printed on LD, LG, LT, ST, A3, B4, A4, B5 and A5 size paper, and are printed in the printing range of each size of paper. No printing will occur in the margins borders of the received originals as indicated by the gray borders on the figures below.

Tip

Set the paper in the drawers or the Large Capacity Feeder (optional).
The paper set on the bypass tray is not available.

Drawers can be set for Fax only. See the [Operator's Manual for Basic Function].

- If a specified drawer is set for Fax as a drawer by type, only the paper set in this drawer is used when the equipment receives a Fax.
- The paper that can be set in the drawer for Fax is LD, LG, LT, LT-R, A3, A4, A4-R and B4 sizes.
- * If you want to set ST-R, A5-R, B5 or B5-R size paper in the drawer for Fax, ask your service technician.

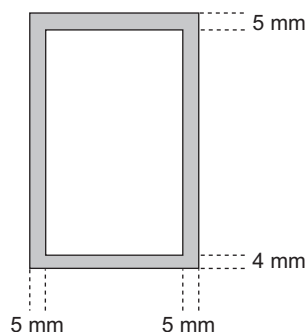
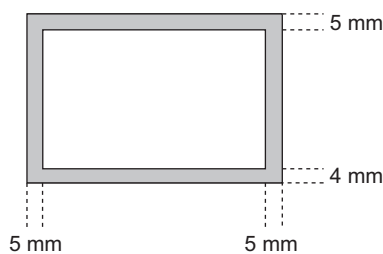

Setting RX printing during default setup

The received data are printed on paper which fits the incoming original size.































- When the incoming original is shorter or the same length as the paper printing area, it is printed in the original size.
 - When the incoming original is larger than the paper printing area, it is printed according to the following priority: (Initial setting: Discard printing ON, Reduction printing ON) To change the configuration to OFF, see [P.158](#) "4. Setting RX Printing".
1. When originals are up to 10 mm larger than the printing area; the part of the originals that exceeds the paper printing area is discarded.
 2. When originals are at least 10 mm larger than the printing area; If the original can fit on a single sheet of paper by reducing it to 90%* of its original size, it is reduced and printed on a sheet of paper (Reduction printing). If the original cannot fit on a single sheet of paper, it is printed on 2 sheets of paper.
* LG size originals are reduced to 75% to fit onto LT or LT-R paper.
 3. Originals are printed on larger size paper.

Paper priority when there is no same size paper

When RX reduction printing and discard printing are set to "ON", paper is selected according to the following priority:

1. Paper of the same size and same orientation as the received original
2. Paper of the same size but with a different orientation to the received original
3. Paper of the same orientation but larger than the received original





















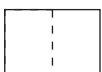



• American Size

Priority \ Size of Original being Received	Ledger	Legal	Letter	Letter	Statement	COMP
1.	 Ledger	 Legal	 Letter	 Letter	 Statement	 COMP
2.	 Ledger	 Legal	 Letter	 Letter	 Statement	 COMP
3.		 Letter Reduced to 75%	 Letter	 Letter	 Letter	 Ledger
4.		 Letter Reduced to 75%	 Ledger	 Legal	 Letter	
5.		 COMP	 Legal	 COMP	 Legal	
6.		 Ledger	 COMP	 Ledger	 COMP	
6.					 Ledger	

Tip

When the correct paper size is not available, the scanned original will be reduced by remote fax to fit an available size paper (such as LD to LT) in addition to printing a received document on a larger size paper.

• European Size

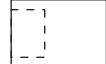
Priority \ Size of Original being Received	A3	B4	A4	A4	A5	FOLIO
1.	 A3	 B4	 A4	 A4	 A5	 FOLIO
2.		 A3	 A4	 A4	 A4	 B4
3.			 A3	 FOLIO	 A4	 A3
4.			 FOLIO	 B4	 FOLIO	 A4 Reduced to 75%
5.			 B4	 A3	 B5	 A4 Reduced to 75%
6.					 B5	
7.					 B4	
8.					 A3	

Tip

The paper priority varies according to the RX reduction printing and discard printing settings. For details, contact your service technician.

4. CHECKING AND CANCELING THE COMMUNICATIONS

1. Checking Transmission Result.....	66
• Checking reserved transmissions	66
• Checking communication status (log)	68
• Address registration from send/receive log.....	70
2. Canceling Transmissions	72

1. Checking Transmission Result

Checking reserved transmissions

You can check the following information of the transmission status (job) in the list on the touch panel.

File No.	To	Date, Time	Pages	Status
003	23	04, 14:47	1	Line1
002	USER01	04, 14:57	1	Wait

4

- File number
- Receiver
- Accepted date
- Number of originals
- Transmission status

Line1: Sending on line 1

Network: Sending via Internet Fax

Delayed: Sending via Delayed Transmission Reservation

Wait: Communication is in the standby queue.

Invalid: Under standby due to an invalid department code (N/W-Fax).

For N/W-Fax function, see the [Network Fax Guide].

4 jobs are listed on each screen (page). The job display for 100 jobs (25 pages) are available.

1 Press the [JOB STATUS] button on the control panel.

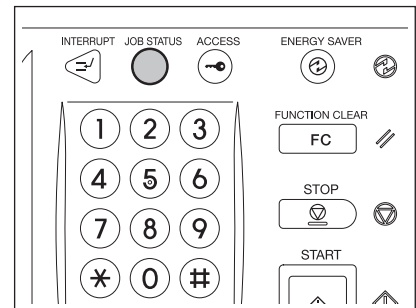

2 Press the [FAX] button.

- If the desired file columns are not displayed, press the [Prev] or [Next] button to switch the screens.
- Files are displayed in order beginning with the newest file.
- To output the list with the current reservation status, press the [RESERVATION LIST] button. (P.122 "Printing reservation list")

Tips

Releasing the department code error

In the status column of "Fax/Internet FAX JOB" list, the job which is in "Invalid" status may appear. In this case, release the invalid job as follows.

- Enter user information required to use the equipment from the control panel.
- Select the file with the invalid code, and press the [RELEASE] button on "Fax/Internet FAX JOB" list.
- The "INVALID" job is sent as a job of the department which the user who performed user authentication belongs to.

Fax/InternetFAX JOB				
File No.	To	Date,Time	Pages	Status
003	23	04,14:47	1	Invalid
002	USER01	04,14:57	1	Wait

1/1

RETURN DELETE RESERVATION LIST RELEASE

Checking communication status (log)

You can check the following information of the communication status (log) in the list on the touch panel.

File No.	To	Date,Time	Pages	Status
005	USER01	04, 14: 58	1	OK
004	USER01	04, 13: 38	0	0050
003	23	04, 11: 29	0	0050
002	USER01	04, 11: 28	0	0050

4

- File number
- Receiver or sender
- Accepted date
- Number of originals
- Communication result
OK: Transmission or reception succeeded.
4-digit error code: Transmission or reception failed. (P.122 “Error code table”)

4 jobs are listed on each screen (page). The job display for 40 jobs (10 pages) are available. The setting can be changed to display the list for 120 jobs (30 pages). (P.125 “Setting the (transmission/reception) journal output and its number”)

1 Press the [JOB STATUS] button on the control panel.

2 Press the [LOG] button to enter the log menu, and then press the [SEND] or [RECEIVE] button.

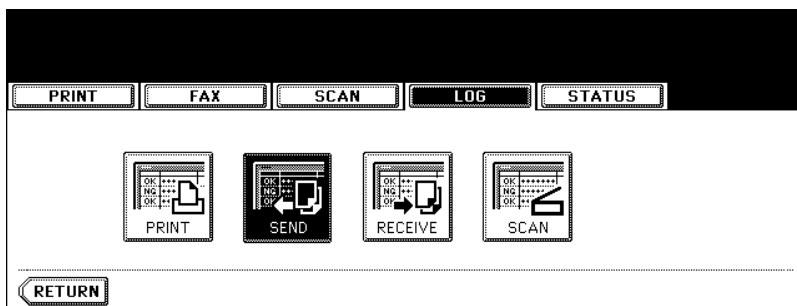

- If the desired file columns are not displayed, press the [Prev] or [Next] button to switch the screens.
- To output the list with the transmission or reception result, press the [JOURNAL] button. (P.120 "1.Manually Printing Lists & Reports")

SEND LOG				
File No.	To	Date_Time	Pages	Status
013	USER01	01,14:58	1	OK
009	USER01	01,13:38	0	0050
008	23	01,11:29	0	0050
007	USER01	01,11:28	0	0050

1/3

Address registration from send/receive log

You can register the information such as the remote Fax numbers and E-mail addresses in the address book from the send/receive log screen.

- * The following information can be registered from the Send log:
 - Remote FAX number which was dialed by direct entry using the digital keys, or which was searched for by the LDAP server
 - E-mail address which was manually entered, or which was searched for by the LDAP server
- * The following information can be registered from the Receive log:
 - Remote FAX number which was dialed by direct entry using the digital keys, or which was searched for by the LDAP server for a Polling Reception
 - E-mail address of the sender

1 Press the [JOB STATUS] button on the control panel.

2 Press the [LOG] button to enter the log menu, and then press the [SEND] or [RECEIVE] button.

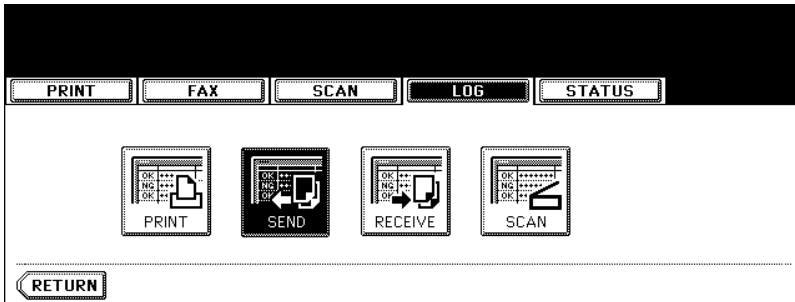

3 Select the remote Fax you want to register in the address book, and then press the [ENTRY] button.

The screenshot shows the SEND LOG screen. At the top, there are buttons for PRINT, FAX, SCAN, LOG, and STATUS. Below the buttons is a table with the following data:

File No.	To	Date,Time	Pages	Status
005	USER01	04, 14: 58	1	OK
004	USER01	04, 13: 38	0	0050
003	23	04, 11: 29	0	0050
002	USER01	04, 11: 28	0	0050

At the bottom of the screen, there are buttons for RETURN, JOURNAL, and ENTRY. The ENTRY button is highlighted. To the right of the buttons, it says 1/5 and there is a Next button.

4 Select the item button you want to register, and then enter the recipient's or sender's information.

The screenshot shows a menu with buttons for PRINT, FAX, SCAN, LOG, and STATUS. Below is the ADDRESS ENTRY screen with the following fields and buttons:

ADDRESS ENTRY		ID NO.	: 0010
FIRST NAME		E-MAIL	
LAST NAME		CORP.	
FAX NO.	23	DEPT.	
2ND FAX		KEYWORD	
OPTION CANCEL ENTER			

- See the [Operator's Manual for Basic Function] for entering letters.
- ID number is automatically numbered.
- See the [User Functions Guide] for registering and correcting the address book.

The screenshot shows the USER09 screen with a virtual keyboard. The keyboard includes buttons for punctuation, numbers, letters, and special keys like Back Space, Shift, Caps Lock, and Next. The ENTER button is highlighted.

5 Press the [ENTER] button.

The screenshot shows the ADDRESS ENTRY screen with the following data entered:

ADDRESS ENTRY		ID NO.	: 0010
FIRST NAME	USER09	E-MAIL	user09@aaa.com
LAST NAME		CORP.	AAA COMPANY
FAX NO.	23	DEPT.	Dept. 1
2ND FAX		KEYWORD	
OPTION CANCEL ENTER			

2. Canceling Transmissions

Canceling transmissions (during scanning)

When an original is being scanned on the original glass:

1 When scanning of the original is finished, press the [JOB CANCEL].

- If you press the [JOB FINISH] button or do nothing for about 45 seconds after finishing the scanning, the scanned data of the original start to be transmitted.
- To change the setting of the scanning conditions, press the [OPTION] button. (P.35 “Setting the scanning conditions for each page”)

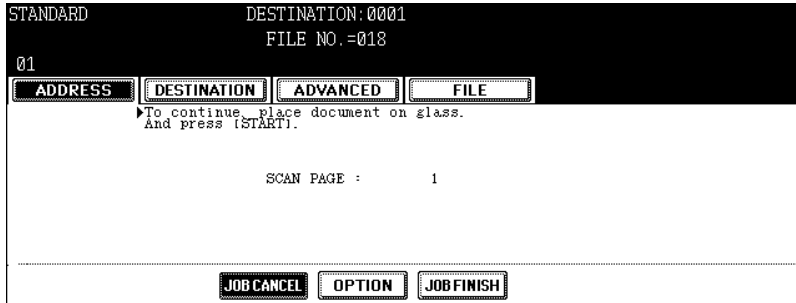

2 Press the [Yes] button.

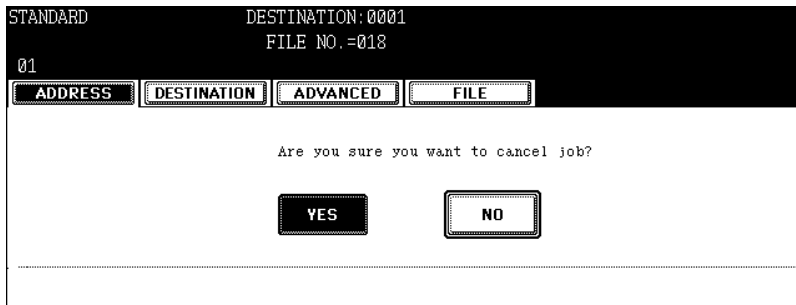

When originals are being scanned using the Reversing Automatic Document Feeder:

1 Press the [STOP] button while the multiple originals are being scanned. Scanning (storing into memory) is paused.

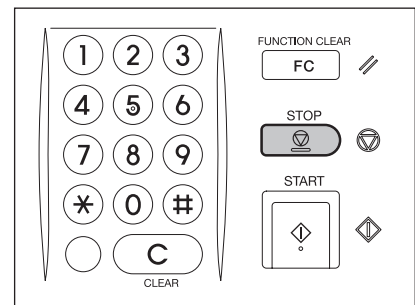

2 To cancel the job, press the [JOB CANCEL] button while scanning is paused.

- To resume scanning, press the [START] button on the control panel.
- When the [JOB FINISH] button is pressed, the scanned data of the original(s) start to be transmitted.
- To change the setting of the scanning conditions, press the [OPTION] button. (P.35 "Setting the scanning conditions for each page")
- If you do nothing for about 45 seconds after the pause of the transmission, the transmission that is currently being scanned is cleared from the memory.

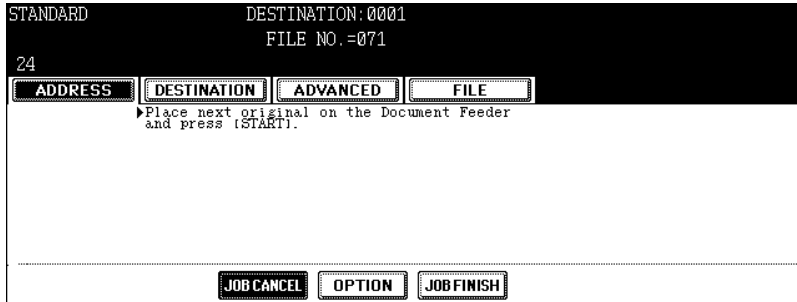

3 Press the [YES] button.

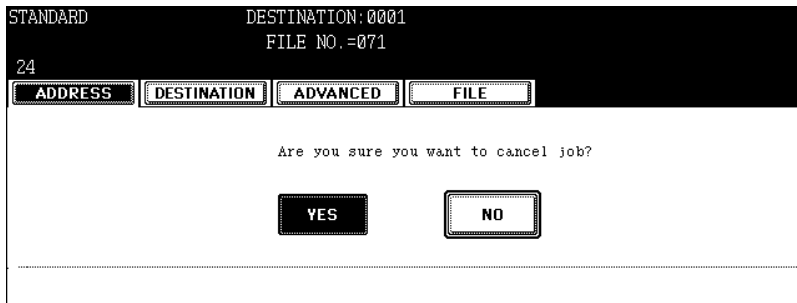

Canceling reserved memory transmissions

This function allows you to cancel reserved memory transmissions that are currently stored in the memory and waiting to be sent (including Delayed Transmission Reservation and Poling Transmission/Reception).

- 1 Press the [JOB STATUS] button on the control panel.
- 2 Press the [FAX] button.
- 3 Press the file to be canceled from memory.
- 4 Press the [DELETE] button.

Fax/InternetFAX JOB

File No.	To	Date,Time	Pages	Status
010	USER01	05,14:48	1	Wait
011	23	05,14:48	1	Wait

Navigation buttons: RETURN, DELETE, RESERVATION LIST, RELEASE. Page indicator: 1/1

- 5 When "Delete OK?" appears, press the [DELETE] button.

Delete OK?

Navigation buttons: DELETED, CANCEL

Canceling transmissions (during memory transmission)

- 1 Press the [JOB STATUS] button on the control panel.
- 2 Press the [FAX] button.
- 3 Select the file that is currently being transmitted.
 - Check that the status column indicates “Line1” (transmitting via line 1).
- 4 Press the [DELETE] button.

File No.	To	Date, Time	Pages	Status
011	23	05, 14:48	1	Line1
010	USER01	05, 14:48	1	Wait

1/1

- 5 When “Delete OK?” appears, press the [DELETE] button.

Delete OK?

DELETE CANCEL

Canceling direct transmission (during scanning)

1 Press the [STOP] button during transmission (scanning).

- The transmission (scanning) operation is stopped.

Tip

Even if you cancel transmission in the direct TX mode, the part of the original that was scanned before transmission was canceled will be sent to the remote Fax.

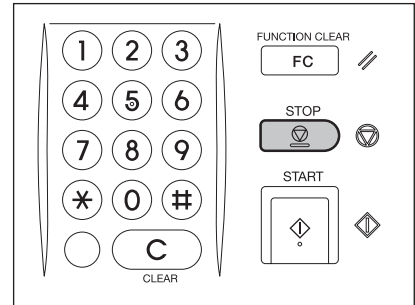

5. ADVANCED FUNCTIONS

1. Transmitting 2-Sided Originals	78
2. Priority Transmission	80
3. Polling Communication	81
4. Mailbox Communication	84
5. Chain Dial Communication	104
6. Delayed Transmission Reservation	106
7. Recovery Transmission.....	109
8. Onramp Gateway	111
9. Offramp Gateway	113
10. Save as File	115

1. Transmitting 2-Sided Originals

This function is used to scan and transmit 2-sided originals with the Reversing Automatic Document Feeder.

- **Placing 2-sided A4/LT originals**

When you place a 2-sided original on the Reversing Automatic Document Feeder, change the direction of the original depending on its bound position as follows:

1. Right-to-left (book-type) original
2. Top-to-bottom (tablet-type) original

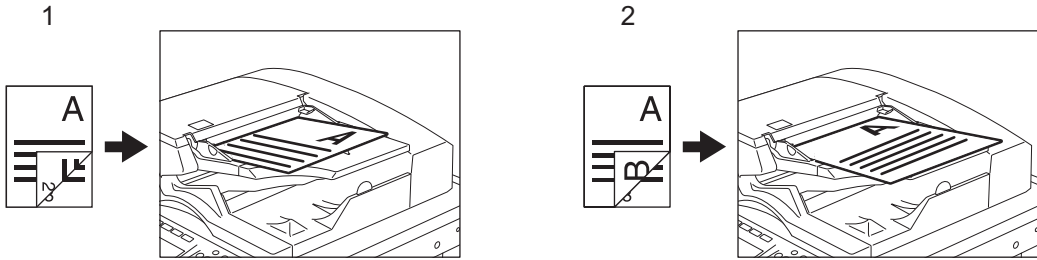

- Note that each setting will automatically return to its default setting when one transmission is completed.

5

1 Place the original(s).

- P.26 "Setting originals"

2 Press the [FAX] button on the control panel.

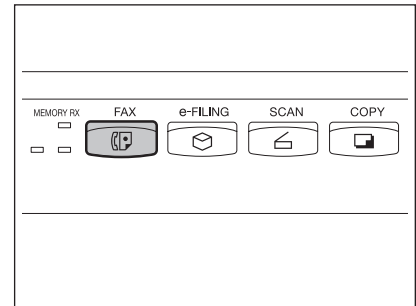

3 Press the [OPTION] button and set the transmission conditions.

- P.29 "4.Setting the Transmission Conditions"

- 4** Press the [ADVANCED] button to enter the advanced menu, and then press the [2-SIDED SCAN] button.

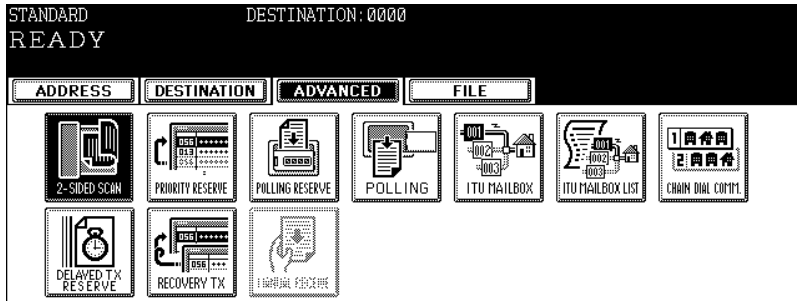

- 5** Press the [BOOK] or [TABLET] button depending on the bound position of the original(s), and then press the [ENTER] button.

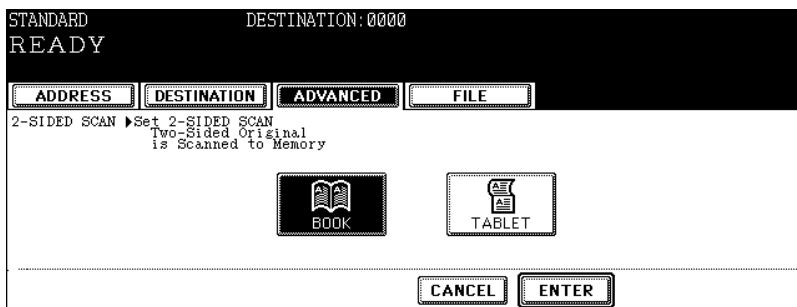

6 Specify the remote Fax

- Entering the Fax number (☞ P.37 "Direct entry with digital keys")
- Selecting from address book (☞ P.38 "Address book entry")
- Selecting by group registration (☞ P.39 "Group entry")
- Selecting using multi-address transmission (☞ P.47 "Multi-address transmission")

- 7** Press the [START] button.

2. Priority Transmission

Priority Transmission allows you to perform a transmission prior to other reserved transmissions (including redial standby).

- For this function, only a direct dialing method (with digital keys) and an address book entry method are available.
- Only one remote Fax can be specified per one transmission in this function.

1 Place the original(s).

- P.26 "Setting originals"

2 Press the [FAX] button on the control panel.

3 Press the [OPTION] button and set the transmission conditions.

- P.29 "4.Setting the Transmission Conditions"

4 Press the [ADVANCED] button to enter the advanced menu, and then press the [PRIORITY RESERVE] button.

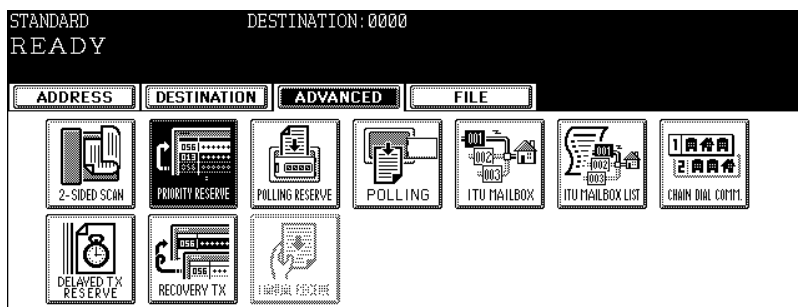

5 Press the [ENTER] button.



6 Specify the remote Fax

- Entering the Fax number (P.37 "Direct entry with digital keys")
- Selecting from address book (P.38 "Address book entry")

7 Press the [START] button.

3. Polling Communication

This function is used when you want to receive a Fax from a sender upon your request. The receiver can receive the Fax whenever he or she wants. This function is set at the sender's side by storing the data of an original into memory. This operation is called polling transmission. The polling reservation is valid for only 1 transmission; the data of the original will be cleared once it has been transmitted upon the receiver's request. The sender can limit the receiver by attaching a password and the receiver's Fax number so that any receiver not identified as the correct receiver with the password and Fax number will not receive the Fax.

* Polling communication with a password can be used only with Toshiba Fax machines.

Polling transmission

1 Place the original(s).

- P.26 "Setting originals"

2 Press the [FAX] button on the control panel.

3 Press the [OPTION] button and set the transmission conditions.

- P.29 "4.Setting the Transmission Conditions"

4 Press the [ADVANCED] button to enter the advanced menu, and then press the [POLLING RESERVE] button.

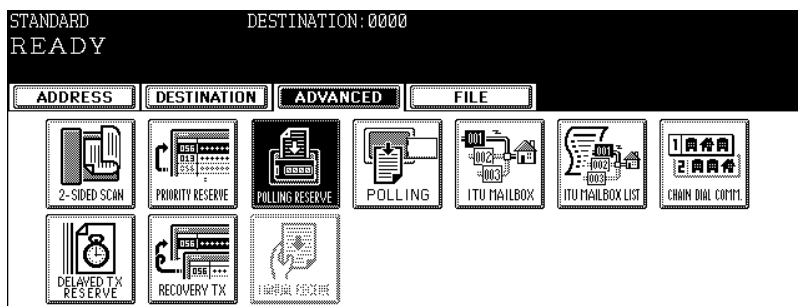

5 Key in the password (4 digits) and/or Fax number (maximum 20 digits) if necessary and then press the [ENTER] button.

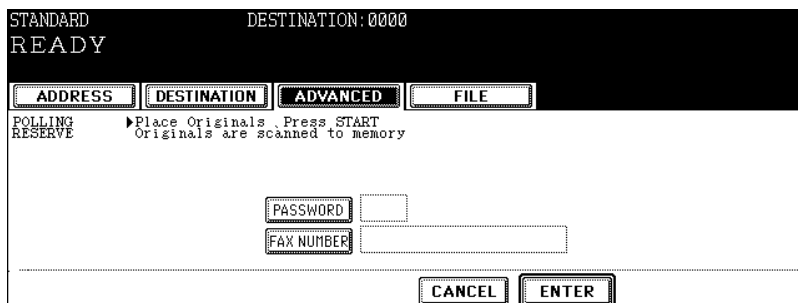

6 Press the [START] button.

- Scanning starts and the scanned data will be stored in a memory.
- Canceling the polling transmission (📖 P.74 "Canceling reserved memory transmissions")

Polling reception

There are 2 types of polling reception as follows:

- Individual polling reception: Receiving a Fax from one sender
- Multi-polling reception: Receiving a Fax from 2 or more senders in a single operation. This function can be used in combination with the direct dialing, address book entry and group entry.

1 Press the [FAX] button on the control panel.

2 Press the [ADVANCED] button to enter the advanced menu, and then press the [POLLING] button.

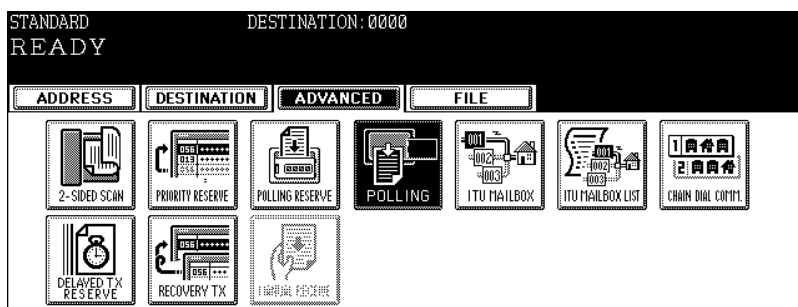

3 Key in the password (4 digits) if the password check is set for the remote Fax, and then press the [ENTER] button.

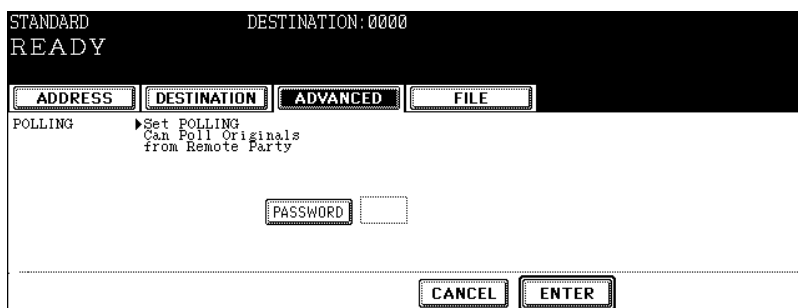

4 Specify the remote Fax

- Individual polling reception:
 - Entering the Fax number (☞ P.37 "Direct entry with digital keys")
 - Selecting from address book (☞ P.38 "Address book entry")
- Multi-polling reception:
 - Selecting by group registration (☞ P.39 "Group entry")
 - Selecting using multi-address transmission (☞ P.47 "Multi-address transmission")

5 Press the [START] button.

4. Mailbox Communication

This function is used to communicate between Fax machines compatible with a mailbox function (ITU-T compatible). The owners of these Fax machines can input or retrieve the data of originals in the mailbox. There are 3 types of mailbox; confidential mailbox, bulletin board mailbox and multi-address relay mailbox. To perform mailbox communication, the mailboxes must be set in advance. Total 300 mailboxes can be set for the 3 types listed below, and an individual password for each box can be set for security protection.

Tip

This equipment also supports the Inbound FAX routing by TSI function that designates a sender's fax number for a mailbox number. "Forward Mailbox" setting on TopAccess makes this function available, and the received document is forwarded to the specified destination (file/Email/e-Filing) according to the sender's fax number. If a mailbox has been created as "Confidential", "Bulletin Board" or "Relay", the received document is not forwarded even when the mailbox number matches the sender's fax number. For details, see the TopAccess Guide.

5

- Confidential mailbox:
Once the data of an original is retrieved from this box, this data will be deleted. If a new data is input in this box under the same box number where another data exists, the new data will be added to the existing data.
- Bulletin board mailbox:
Even if the data of an original is retrieved from this box, this data will not be deleted. If a new data is input in this box under the same box number where another data exists, the new data will overwrite the existing data.
- Multi-address relay mailbox:
A Fax machine with mailbox function transmits a Fax specifying a certain mailbox as a relay mailbox, and then the relay station forwards the Fax to the destination previously registered in the relay mailbox. In this case, the Fax machine of the original sender is called a relay originator, the Fax machine which forwards the Fax is called a relay station and the Fax machine which receives the Fax at the last stage is called a relay destination. A relay station can send a report (relay destination transmission report) to a specified Fax machine involved in the multi-address relay transmission after completing the transmission. A relay station can also print out the Fax from a relay originator always or only when the relay transmission has failed.

Tip

Example of multi-address relay mailbox

If you want to transmit the same original to several offices in New York from Los Angeles office, you can reduce the communication cost utilizing a multi-address relay mailbox function, by setting the New York office "A" as a relay station (see the figures below).

<Procedure>

1. Set a relay mailbox in the New York office "A". (P.87 "Setting up relay mailbox")
2. Transmit the original from the Los Angeles office to the relay mailbox in the New York office "A". (P.100 "Transmitting Fax to mailbox")

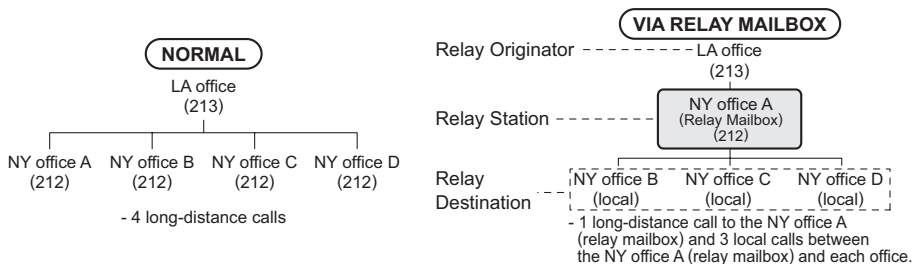

Setting up mailbox for confidential and bulletin board communication

How to create a confidential mailbox or bulletin box mailbox on sender's side is explained here.

- 1 Press the [FAX] button on the control panel.
- 2 Press the [ADVANCED] button to enter the advanced menu, and then press the [ITU MAILBOX] button.

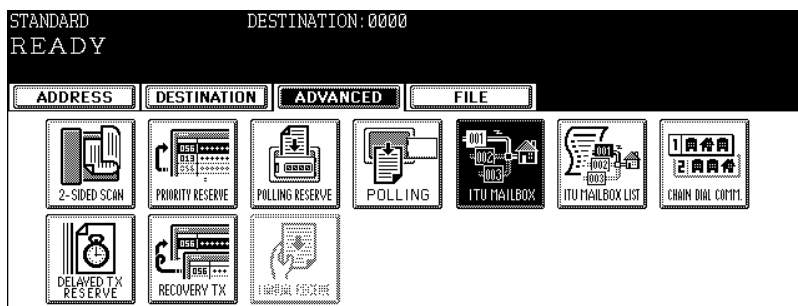

- 3 Press the [CONFIDENTIAL] (or [BULLETIN BD.]) button, and then press the [BOX SETUP] button.

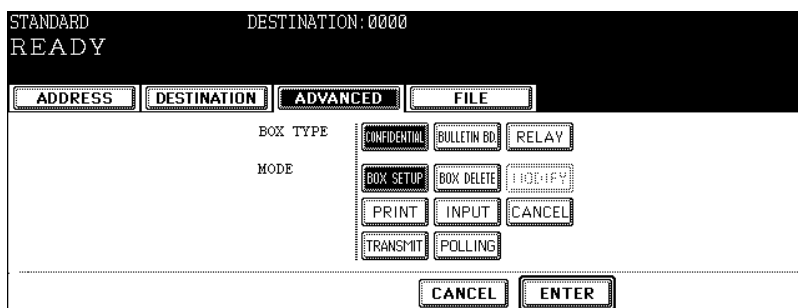

- 4 Press the [ENTER] button.

5 Press the [BOX NUMBER] button to enter the next menu, key in the box number(s) (maximum 20 digits), and then press the [ENTER] button.

- If you want to set up a password, press the [PASSWORD] button to enter the next menu, key in the password (maximum 20 digits) and then press the [ENTER] button.
- The password being entered is indicated with "*".

5

Tips

- A password is required to Transmit to a Bulletin Board Mailbox from a remote fax.
- A password is required to Poll a Confidential Mailbox from a remote fax.

6 Confirm that the registered information is correct, and then press the [ENTER] button.

- If the entered box number has already been registered, "Already assigned" appears. Press the [BOX NUMBER] button to enter the next menu, press the [Back Space] button to delete this box number and key in a new box number.

Tip

The registered mailboxes can be confirmed in a mailbox list. (📄 P.123 "Printing ITU mailbox list")

Setting up relay mailbox

How to create a relay mailbox on sender's side is explained here.

- 1 Press the [FAX] button on the control panel.
- 2 Press the [ADVANCED] button to enter the advanced menu, and then press the [ITU MAILBOX] button.

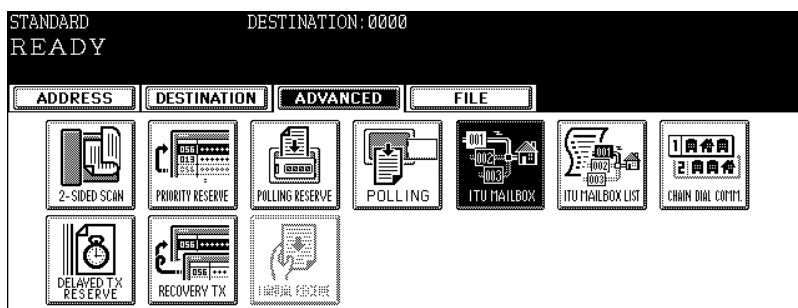

- 3 Press the [RELAY] button, and then press the [BOX SETUP] button.

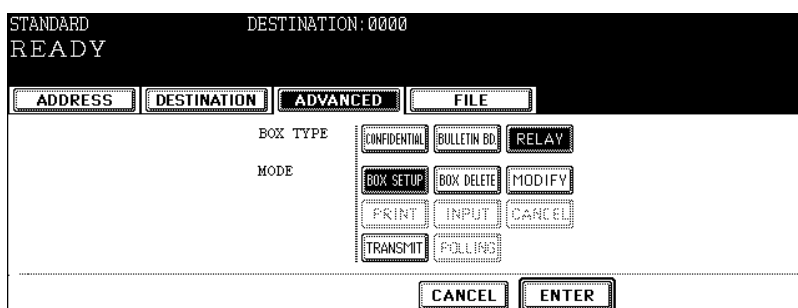

- 4 Press the [ENTER] button.

5 Press the [BOX NUMBER] button to enter the next menu, key in the box number(s) (maximum 20 digits), and then press the [ENTER] button.

- If you want to set up a password, press the [PASSWORD] button to enter the next menu, key in the password (maximum 20 digits) and then press the [ENTER] button.
- The password being entered is indicated with "*".

6 Specify the relay destination to be registered from the address book or the group list.

- Press the [GROUP] button to enter the group list menu.
- Press the [Prev] or [Next] button to scroll through the menus.
- You can search the desired destination by its ID number (P.40 "Searching by ID number") and address (P.42 "Searching by address (Search address)").

7 Confirm that the registered information is correct, and then press the [ENTER] button.

8 If you want to send the relay destination transmission report, press the [YES] button.

- If you press the [NO] button here, steps 9 and 10 are not necessary.
- For the relay destination transmission report, see P.124 “2.Automatically Printing Lists & Reports”.

STANDARD DESTINATION: 0000
RELAY END NUMBER

ADDRESS DESTINATION ADVANCED FILE

RELAY END REPORT

YES NO

CANCEL

Note

The default operation of the relay destination transmission report is "On Error". For configuration of this operation, see P.127 “Setting the communication report output”.

9 Specify the remote Fax to receive the relay destination transmission report from the address book or by a direct dialing (with the digital keys).

- Only one remote Fax can receive this report.
- To correct the selected remote Fax,
Specifying from the address book:
Press the [FAX] button of the selected remote Fax (the highlight will be cleared) and then press the [FAX] button of the correct remote Fax.
Specifying by a direct dialing:
Press the [Back Space] button to delete the wrong number and then key in the correct number.

STANDARD DESTINATION: 0001
RELAY END TERMINAL REPORT
25

ADDRESS DESTINATION ADVANCED FILE

ADDRESS BOOK

025	USER25	FAX	029		
026			030		
027			031		
028			032		

KNOWN ID
SEARCH ADDRESS
COPY

BACK SPACE MAIL ADDRESS CANCEL ENTER 2/125 Next Prev

10 Confirm that the registered information is correct, and then press the [ENTER] button.

Tip

The registered mailboxes can be confirmed in a mailbox list. (P.123 “Printing ITU mailbox list”)

- 11** Press the [ALWAYS] button to always print out the received Fax, or press the [ON ERROR] button to print it out only when the relay transmission has failed.

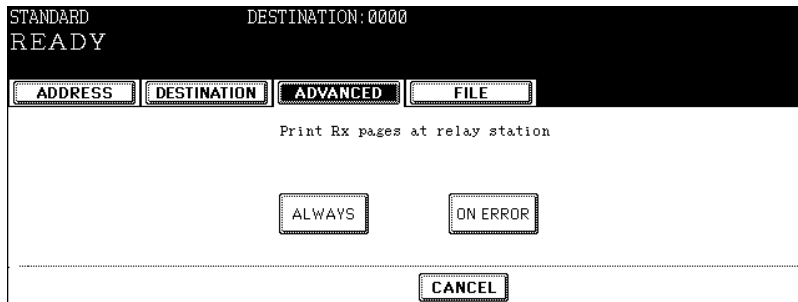

Deleting mailbox

How to delete a mailbox no longer needed is explained here.

- 1 Press the [FAX] button on the control panel.
- 2 Press the [ADVANCED] button to enter the advanced menu, and then press the [ITU MAILBOX] button.

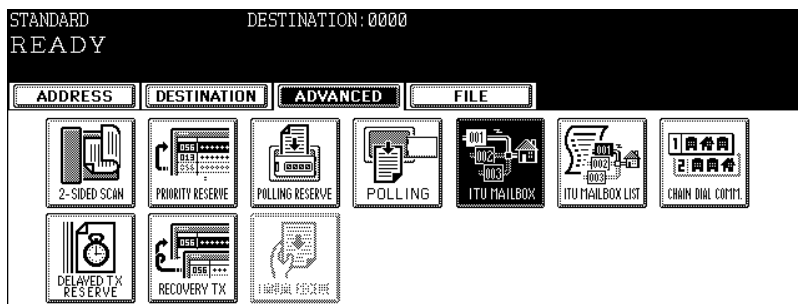

- 3 Press the [CONFIDENTIAL] (or [BULLETIN BD.] or [RELAY]) button, and then press the [BOX DELETE] button.

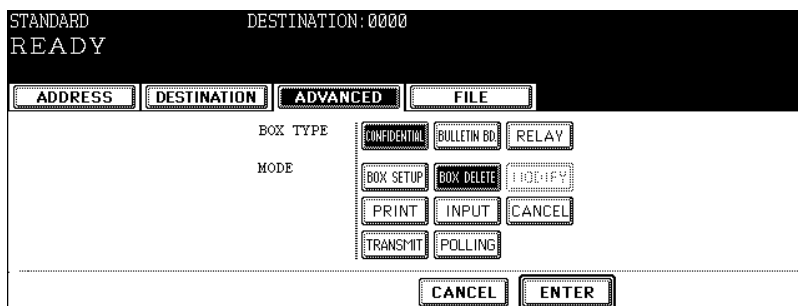

- 4 Press the [ENTER] button.
 - If the selected mailbox has not been set, "No entry" appears.

5 Press the [BOX NUMBER] button to enter the next menu, key in the box number(s) (maximum 20 digits), and then press the [ENTER] button.

- If a password has been set, press the [PASSWORD] button to enter the next menu, key in the password (maximum 20 digits) and then press the [ENTER] button.
- * You can delete the mailbox with the administrator password. Ask the administrator about the administrator password.

5

6 Press the [ENTER] button.

7 Press the [YES] button.

- In case of deleting a confidential mailbox or a bulletin board mailbox, "Not allowed now" appears if the [YES] button is pressed while some data are still in these mailboxes.
- If the box number keyed in is not correct, "No entry" appears. If the password keyed in is not correct, "Invalid number" appears. Key in the correct box number or password.

Modifying relay mailbox

How to modify the content of a relay mailbox is explained here.

- 1 Press the [FAX] button on the control panel.
- 2 Press the [ADVANCED] button to enter the advanced menu, and then press the [ITU MAILBOX] button.

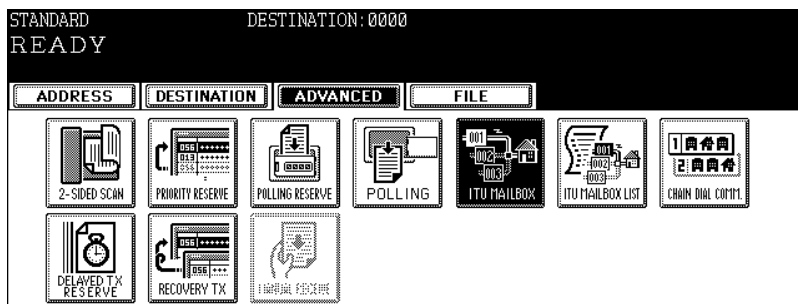

- 3 Press the [RELAY] button, and then press the [MODIFY] button.

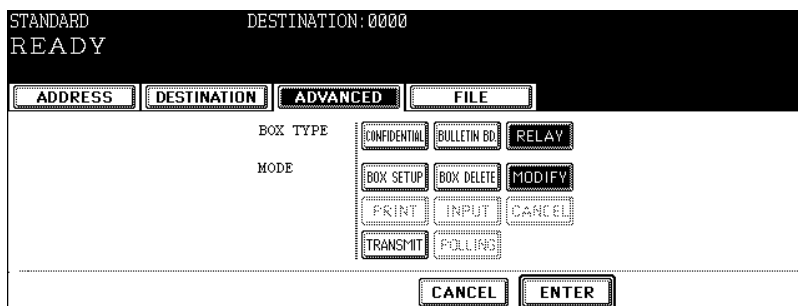

- 4 Press the [ENTER] button.
 - If the selected mailbox has not been set, "No entry" appears.

5 Press the [BOX NUMBER] button to enter the next menu, key in the box number(s) (maximum 20 digits), and then press the [ENTER] button.

- If a password has been set, press the [PASSWORD] button to enter the next menu, key in the password (maximum 20 digits) and then press the [ENTER] button.

5 Press the [ENTER] button.

- If the box number keyed in is not correct, "No entry" appears. If the password keyed in is not correct, "Invalid number" appears. Key in the correct box number or password.

7 Correct the remote Fax. (The field of the remote Fax currently selected is highlighted.)

- You can add a remote Fax from the address book or the registered group.
- To delete the remote Fax, press the [FAX] button of the highlighted field again.
- Press the [GROUP] button to enter the group list menu.
- Press the [Prev] or [Next] button to scroll through the menus.
- You can search the desired destination by its ID number (P.40) and address (P.42).

001 USER01	FAX	005 USER05	FAX	E-MAIL
002 USER02	FAX	E-MAIL	006 USER06	FAX
003 USER03	FAX	E-MAIL	007 USER07	FAX
004 USER04	FAX	E-MAIL	008 USER08	FAX
				E-MAIL

8 Confirm that the registered information is correct, and then press the [ENTER] button.

9 If you want to send the relay destination transmission report, press the [YES] button.

- If you press the [NO] button here, steps 10 and 11 are not necessary.
- For the relay destination transmission report, see (P.124 “2.Automatically Printing Lists & Reports”).

STANDARD DESTINATION: 0000
RELAY END NUMBER

ADDRESS DESTINATION ADVANCED FILE

RELAY END REPORT

YES NO

CANCEL

10 Specify the remote Fax to receive the relay destination transmission report from the address book or by a direct dialing (with the digital keys).

- Only one remote Fax can receive this report.
- To change the selected remote Fax, delete it and specify a new one.

STANDARD DESTINATION: 0001
RELAY END TERMINAL REPORT
25

ADDRESS DESTINATION ADVANCED FILE

ADDRESS BOOK

025	USER25	FAX	029		
026			030		
027			031		
028			032		

KNOWN ID
SEARCH ADDRESS
GROUP

BACK SPACE E-MAIL ADDRESS CANCEL ENTER 2/125 Next Prev

11 Confirm that the registered information is correct, and then press the [ENTER] button.

- The mailbox has been set.

12 Press the [ALWAYS] button to always print out the received Fax, or press the [ON ERROR] button to print it out only when the relay transmission has failed.

STANDARD DESTINATION: 0000
READY

ADDRESS DESTINATION ADVANCED FILE

Print Rx pages at relay station

ALWAYS ON ERROR

CANCEL

Printing Fax out of mailbox

How to print a Fax out of a confidential mailbox or a bulletin board mailbox on the sender's side is explained here.

- 1 Press the [FAX] button on the control panel.
- 2 Press the [ADVANCED] button to enter the advanced menu, and then press the [ITU MAILBOX] button.

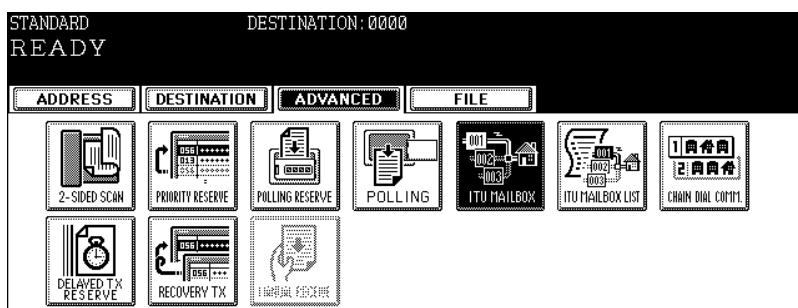

- 3 Press the [CONFIDENTIAL] (or [BULLETIN BD.]) button, and then press the [PRINT] button.

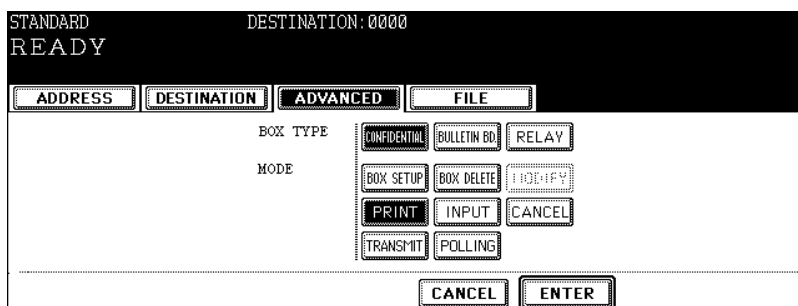

- 4 Press the [ENTER] button.
 - If the selected mailbox has not been set, "No entry" appears.

5 Press the [BOX NUMBER] button to enter the next menu, key in the box number(s) (maximum 20 digits), and then press the [ENTER] button.

- If a password has been set, press the [PASSWORD] button to enter the next menu, key in the password (maximum 20 digits) and then press the [ENTER] button.

STANDARD DESTINATION: 0000
READY

ADDRESS DESTINATION ADVANCED FILE

CONFIDENTIAL PRINT ▶Enter the Box Number and Password

BOX NUMBER 001

PASSWORD

CANCEL

6 Press the [START] button.

- If the box number keyed in is not correct, "No entry" appears. If the password keyed in is not correct, "Invalid number" appears. Key in the correct box number or password.

5

Inputting data in confidential / bulletin board mailbox

How to input a Fax data into a confidential mailbox or a bulletin board mailbox on the sender's side is explained here.

1 Place the original(s).

- P.26 "Setting originals"

2 Press the [FAX] button on the control panel.

3 Press the [OPTION] button and set the transmission conditions.

- P.29 "4.Setting the Transmission Conditions"

4 Press the [ADVANCED] button to enter the advanced menu, and then press the [ITU MAILBOX] button.

STANDARD DESTINATION: 0000
READY

ADDRESS DESTINATION ADVANCED FILE

2-SIDED SCAN PRIORITY RESERVE POLLING RESERVE POLLING ITU MAILBOX ITU MAILBOX LIST CHAIN DIAL COM1

DELAYED TX RESERVE RECOVERY TX HIGH RESERVE

5 Press the [CONFIDENTIAL] (or [BULLETIN BD.]) button, and then press the [INPUT] button.

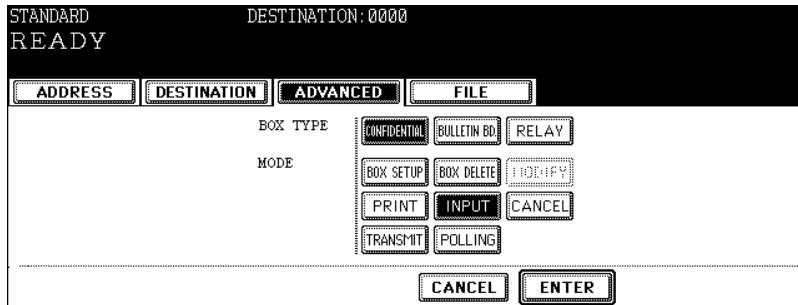

6 Press the [ENTER] button.

- If the selected mailbox has not been set, "No entry" appears.

7 Press the [BOX NUMBER] button to enter the next menu, key in the box number(s) (maximum 20 digits), and then press the [ENTER] button.

- If a password has been set, press the [PASSWORD] button to enter the next menu, key in the password (maximum 20 digits) and then press the [ENTER] button.

8 Press the [ENTER] button.

- If the box number keyed in is not correct, "No entry" appears. If the password keyed in is not correct, "Invalid number" appears. Key in the correct box number or password.

9 Press the [START] button.

- The original data is registered in the mailbox as it is scanned to memory.
- When you cancel the registration, press the [STOP] button and then press the [JOB CANCEL] button.

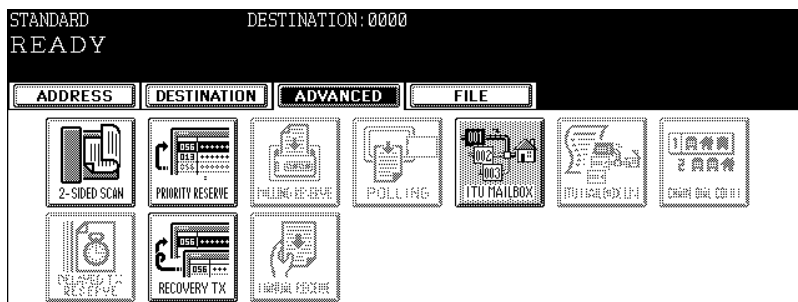

Canceling data in mailbox

How to delete Fax data in a confidential mailbox or a bulletin board mailbox on the sender's side is explained here.

- 1 Press the [FAX] button on the control panel.
- 2 Press the [ADVANCED] button to enter the advanced menu, and then press the [ITU MAILBOX] button.

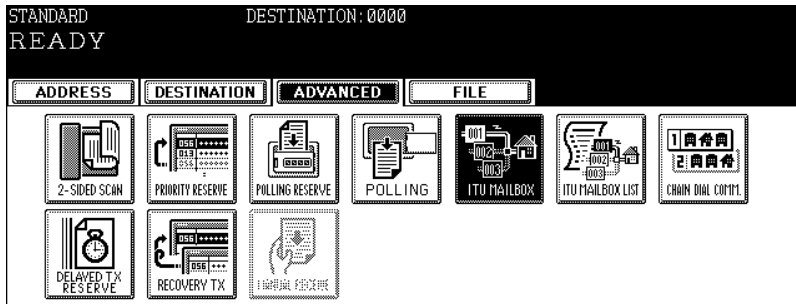

- 3 Press the [CONFIDENTIAL] (or [BULLETIN BD.]) button, and then press the [CANCEL] button.

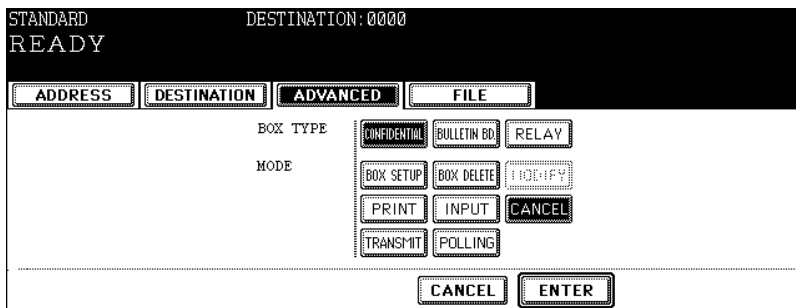

- 4 Press the [ENTER] button.
 - If the selected mailbox has not been set, "No entry" appears.
- 5 Press the [BOX NUMBER] button to enter the next menu, key in the box number(s) (maximum 20 digits), and then press the [ENTER] button.
 - If a password has been set, press the [PASSWORD] button to enter the next menu, key in the password (maximum 20 digits) and then press the [ENTER] button.
 - * You can delete a confidential mailbox or a bulletin board mailbox with the administrator password. Ask the administrator about the administrator password.

- 6 Press the [ENTER] button.

7 Press the [YES] button.

- The data has been deleted from the mailbox.
- If the box number keyed in is not correct, "No entry" appears. If the password keyed in is not correct, "Invalid number" appears. Key in the correct box number or password.



Transmitting Fax to mailbox

How to transmit and register Fax data into mailbox on receiver's side (remote Fax) is explained here.

1 Place the original(s).

- P.26 "Setting originals"

2 Press the [FAX] button on the control panel.

3 Press the [OPTION] button and set the transmission conditions.

- P.29 "4.Setting the Transmission Conditions"

4 Press the [ADVANCED] button to enter the advanced menu, and then press the [ITU MAILBOX] button.

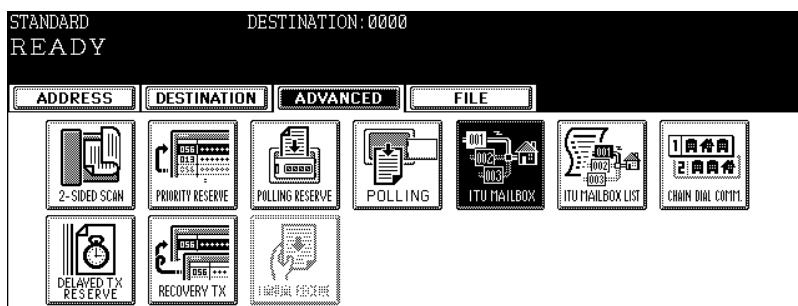

5 Press the [CONFIDENTIAL] (or [BULLETIN BD.] or [RELAY]) button, and then press the [TRANSMIT] button.

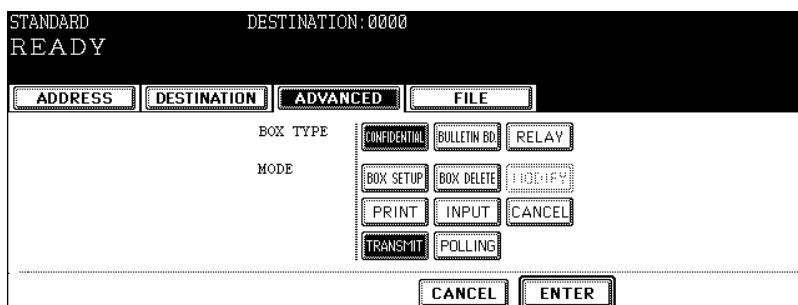

6 Press the [ENTER] button.

7 Press the [BOX NUMBER] button to enter the next menu, key in the box number(s) (maximum 20 digits), and then press the [ENTER] button.

- If a password has been set, press the [PASSWORD] button to enter the next menu, key in the password (maximum 20 digits) and then press the [ENTER] button.

Tip

A password entry is necessary for the data transmission of a bulletin board mailbox.

8 Press the [ENTER] button.

9 Specify the remote Fax

- Entering the Fax number (☞ P.37 "Direct entry with digital keys")
- Selecting from address book (☞ P.38 "Address book entry")
- Selecting by group registration (☞ P.39 "Group entry")
- Selecting using multi-address transmission (☞ P.47 "Multi-address transmission")

10 Press the [START] button.

- The original data is transmitted to the remote mailbox after it is scanned to memory.
- If you want to cancel the transmission during scanning, press the [STOP] button and then press the [JOB CANCEL] button.
- If you want to cancel the transmission while underway, press [JOB STATUS], [FAX], select the correct entry, and press [DELETE].
☞ P.75 "Canceling transmissions (during memory transmission)"

Tips

- The registered box number will be transmitted a SUB address.
- The registered password will be transmitted a SID.

Polling data out of mailbox

How to poll (retrieve) Fax data out of a confidential mailbox or a bulletin board mailbox on receiver's side (remote Fax) is explained here.

- 1 Press the [FAX] button on the control panel.
- 2 Press the [ADVANCED] button to enter the advanced menu, and then press the [ITU MAILBOX] button.

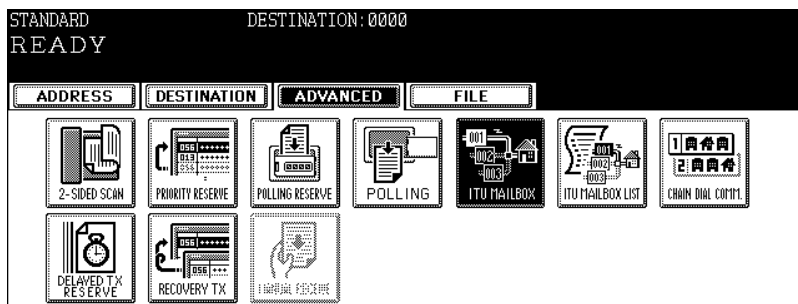

- 3 Press the [CONFIDENTIAL] (or [BULLETIN BD.]) button, and then press the [POLLING] button.
- 4 Press the [ENTER] button.

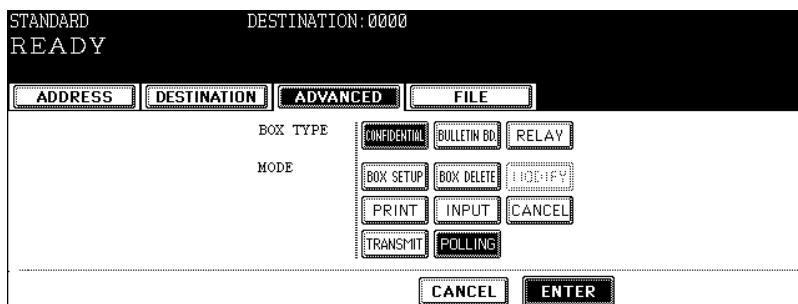

5 Press the [BOX NUMBER] button to enter the next menu, key in the box number(s) (maximum 20 digits), and then press the [ENTER] button.

- If a password has been set, press the [PASSWORD] button to enter the next menu, key in the password (maximum 20 digits) and then press the [ENTER] button.

Tip

A password entry is necessary for the data polling out of a confidential mailbox.

The screenshot shows a menu interface on a device. At the top, it says 'STANDARD' and 'DESTINATION: 0000'. Below that, 'READY' is displayed. There are four menu options: 'ADDRESS', 'DESTINATION', 'ADVANCED', and 'FILE'. The 'CONFIDENTIAL POLLING' option is selected, and a prompt says 'Enter the Box Number and Password'. Below the prompt, there are two input fields: 'BOX NUMBER' with '001' entered, and 'PASSWORD' which is empty. At the bottom, there are 'CANCEL' and 'ENTER' buttons.

5

6 Press the [ENTER] button.

7 Specify the remote Fax

- Entering the Fax number (☞ P.37 "Direct entry with digital keys")
- Selecting from address book (☞ P.38 "Address book entry")
- Selecting by group registration (☞ P.39 "Group entry")
- Selecting using multi-address transmission (☞ P.47 "Multi-address transmission")

8 Press the [START] button.

- The data is polled (retrieved) out of the mailbox and received as a Fax.

Tips

- The registered box number is transmitted as an SEP address.
- The registered password is transmitted as a PWD.

5. Chain Dial Communication

This function is used when you want to combine several numbers to select remote Fax machines using long distance carriers and specialized access lines. You can combine sets of numbers (address book entry and direct entry) by first pressing the [CHAIN DIAL COMM.] button.

* 128 digits of numbers in total can be set in this function.

1 Place the original(s).

- P.26 "Setting originals"

2 Press the [FAX] button on the control panel.

3 Press the [OPTION] button and set the transmission conditions.

- P.29 "4.Setting the Transmission Conditions"

4 Press the [ADVANCED] button to enter the advanced menu, and then press the [CHAIN DIAL COMM.] button.

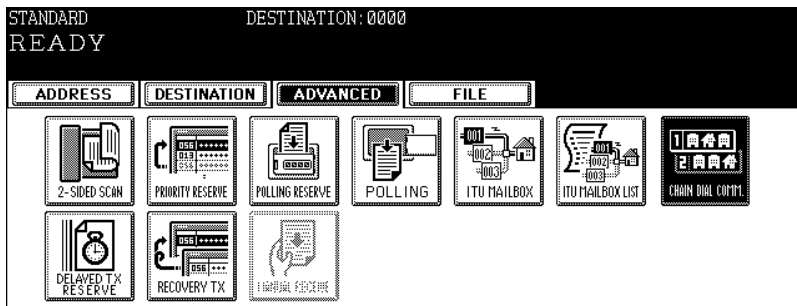

5 Specify the number to be dialed first either from the address book or by direct dialing.

- e.g. Key in the dial out number (011 if calling from the U.S.A.).

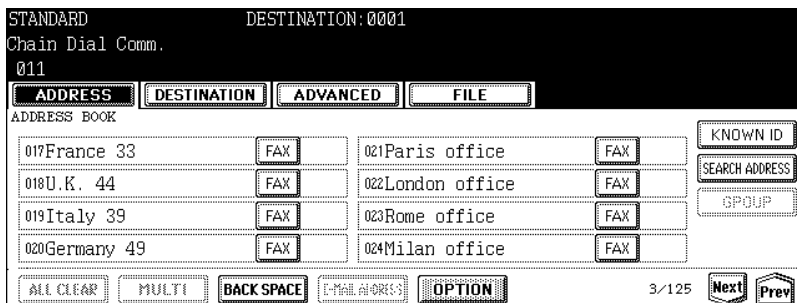

6 Specify the number to be dialed next either from the address book or by direct dialing.

- e.g. Press the [Italy 39] button in the address book as an international code, and then press the [Rome Office] button in the address book.

STANDARD DESTINATION: 0001
Chain Dial Comm.
01114

ADDRESS	DESTINATION	ADVANCED	FILE
---------	-------------	----------	------

ADDRESS BOOK

017 France 33	FAX	021 Paris office	FAX	KNOWN ID
018 U.K. 44	FAX	022 London office	FAX	SEARCH ADDRESS
019 Italy 39	FAX	023 Rome office	FAX	GROUP
020 Germany 49	FAX	024 Milan office	FAX	

ALL CLEAR MULTI BACK SPACE E-MAIL ADDRESS OPTION 3/125 Next Prev

STANDARD DESTINATION: 0001
Chain Dial Comm.
0111455

ADDRESS	DESTINATION	ADVANCED	FILE
---------	-------------	----------	------

ADDRESS BOOK

017 France 33	FAX	021 Paris office	FAX	KNOWN ID
018 U.K. 44	FAX	022 London office	FAX	SEARCH ADDRESS
019 Italy 39	FAX	023 Rome office	FAX	GROUP
020 Germany 49	FAX	024 Milan office	FAX	

ALL CLEAR MULTI BACK SPACE E-MAIL ADDRESS OPTION 3/125 Next Prev

7 Press the [START] button.

- The transmission will start in the order of the remote Fax machines entered.

6. Delayed Transmission Reservation

This function is used when you want to transmit a Fax at a specified date and time. It is useful when you want to make use of off-peak discounts (e.g. nighttime) or you want to transmit a Fax to a country which has a time difference.

- The acceptable range of reservation is up to one month later.
- The date, hour and minute of reception time can be set.
- The date and time of reception can also be set in a polling reception.

Using delayed transmission reservation

1 Place the original(s).

- P.26 "Setting originals"

2 Press the [FAX] button on the control panel.

3 Press the [OPTION] button and set the transmission conditions.

- P.29 "4.Setting the Transmission Conditions"

4 Press the [ADVANCED] button to enter the advanced menu, and then press the [DELAYED TX RESERVE] button.

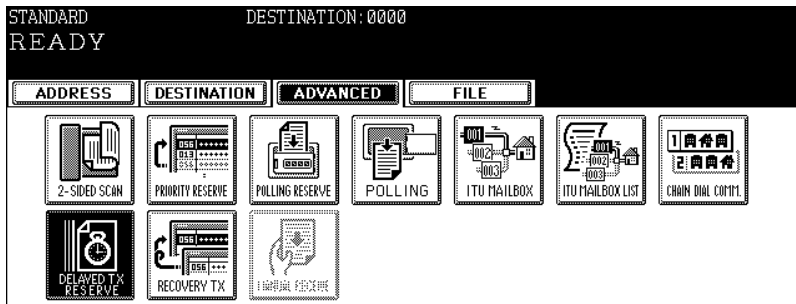

5 Key in the date, hour, and minute.

- Press the [◀] and [▶] buttons to move the cursor.
- Key in the time using the 24-hour clock system.
- To correct the entry, press the [CLEAR] button, and then key in the correct number.

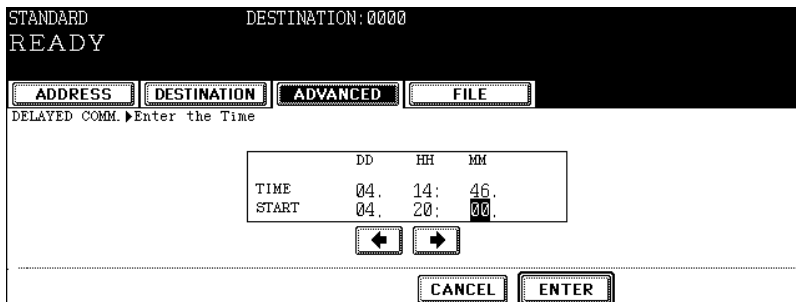

6 Press the [ENTER] button.

7 Specify the remote Fax

- Entering the Fax number (☞ P.37 "Direct entry with digital keys")
- Selecting from address book (☞ P.38 "Address book entry")
- Selecting by group registration (☞ P.39 "Group entry")
- Selecting using multi-address transmission (☞ P.47 "Multi-address transmission")

8 Press the [START] button.

- Canceling delayed transmission reservation of which status is "Wait" (☞ P.74 "Canceling reserved memory transmissions")
- Canceling delayed transmission that is currently being transmitted (☞ P.75 "Canceling transmissions (during memory transmission)")

Releasing delayed transmission reservation

How to release a delayed transmission reservation and perform a memory transmission is explained here.

1 Press the [JOB STATUS] button on the control panel.

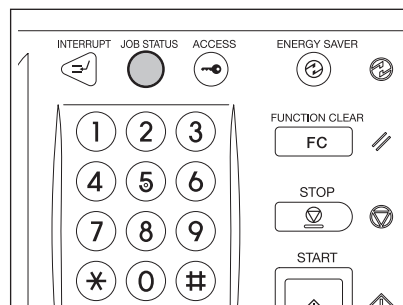

2 Press the [FAX] button.

3 Select the data to be released.

- "Delayed" appears in the status field of the subject data.

File No.	To	Date,Time	Pages	Status
011	USER01	04, 14:47	1	Delayed

PRINT FAX SCAN LOG STATUS

Fax/InternetFAX JOB

RETURN DELETE RESERVATION LIST RELEASE

1/1

4 Press the [RELEASE] button.

- The reservation is canceled and the memory transmission is performed.
- Canceling the delayed transmission reservation of which status is "Wait" (P.74 "Canceling reserved memory transmissions")
- Canceling the delayed transmission that is currently being transmitted (P.75 "Canceling transmissions (during memory transmission)")

File No.	To	Date,Time	Pages	Status
011	USER01	04, 14:47	1	Delayed

1/1

5

Tip

To cancel the delayed transmission reservation of which status is "Delayed", press the [DELETE] button.

7. Recovery Transmission

This function is used to transmit a Fax without placing an original again when the Fax was not transmitted after the specified number of redial. The Fax data of the failed transmission will be retained in a memory, and you can select and retrieve the data to transmit again in the operation on the touch panel. The retention period of the data needs to be set in advance. (P.166 “5.Setting Recovery Transmission”)

Using recovery transmission

- 1 Press the [FAX] button on the control panel.
- 2 Press the [ADVANCED] button to enter the advanced menu, and then press the [RECOVERY TX] button.

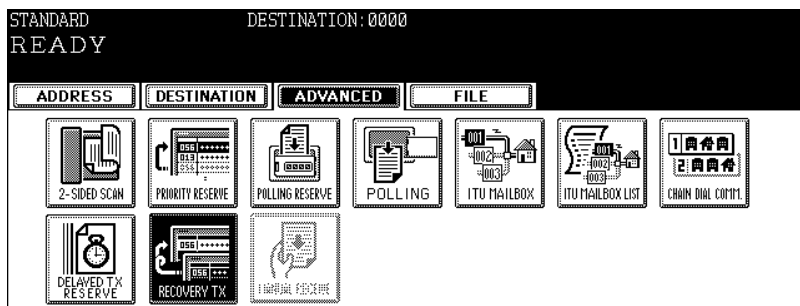

- 3 Select the data you want to retransmit.

- You can change the Fax number only when the first transmission is performed by a direct dialing. Press the [BACK SPACE] button to delete it, and then key in a new number.

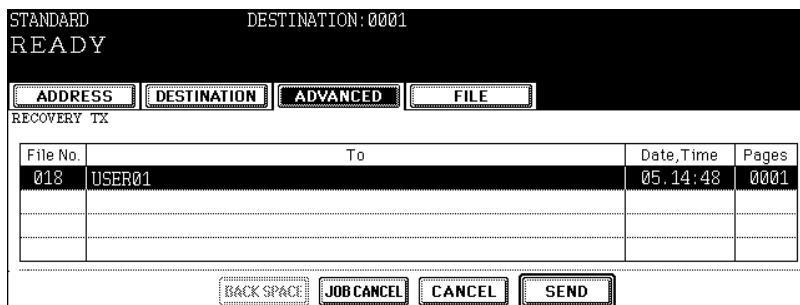

- 4 Press the [SEND] button.

Canceling recovery transmission

- 1 Press the [FAX] button on the control panel.
- 2 Press the [ADVANCED] button to enter the advanced menu, and then press the [RECOVERY TX] button.

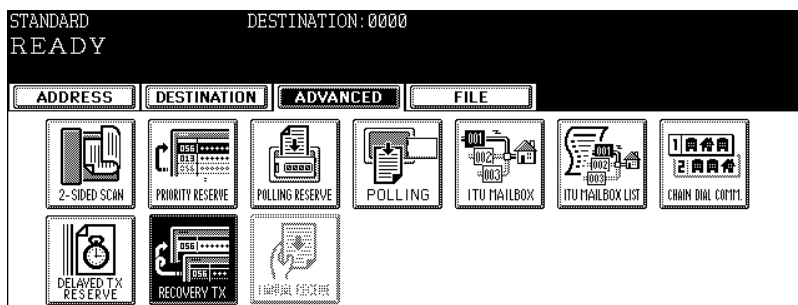

- 3 Select the data you want to cancel.
- 4 Press the [JOB CANCEL] button.

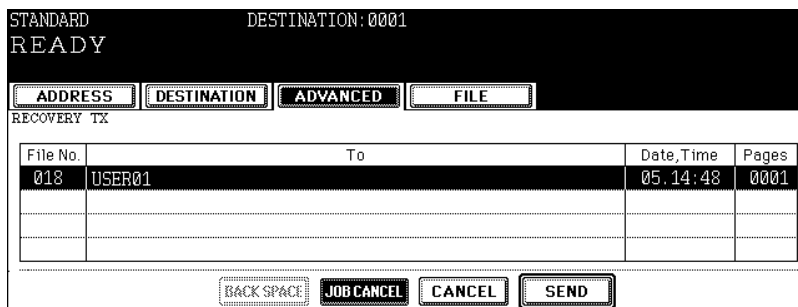

- 5 Press the [YES] button.



8. Onramp Gateway

Onramp gateway overview

This function is used to transmit a Fax from a Fax machine with a mailbox function to an E-mail address registered in the mailbox of a relay station through the relay station.

Tip

To use this function for e-STUDIO520/600/720/850, you need to install the following option: "Printer Kit (GM-1050) and Scanner Kit (GM-4010)" or "Printer/Scanner Kit (GM-2040)"

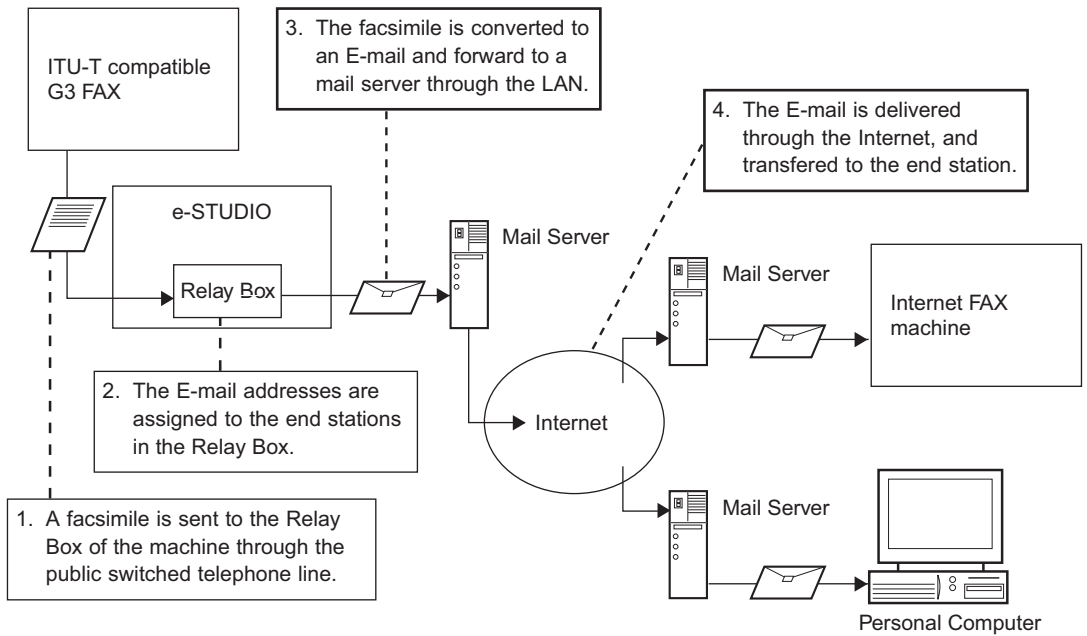

Setting relay mailbox

To use this equipment as a relay station for an onramp gateway transmission, set up a relay mailbox on this equipment and then register an E-mail address as a relay destination. When the onramp gateway function is used, all Fax machines with the mailbox function can transmit a Fax to this equipment (relay station), and this equipment can forward the Fax to the specified E-mail address as an E-mail.

You can select an E-mail address as a relay destination from the address book or group list when you set up a relay mailbox. Register the desired E-mail address into the address book before setting up the relay mailbox.

Tip

Fax numbers, as well as E-mail addresses, can be registered as relay destinations in a relay mailbox. See  P.84 “4.Mailbox Communication” for the details of mailbox communication, how to register a Fax number as a relay destination in a relay mailbox, or how to delete the mailbox. To assign an E-mail address as a relay destination, see “Setup Flow for Onramp Gateway” of the Network Administration Guide. To assign Internet FAX as a relay destination, see “Setup Flow for Internet Fax” of the Network Administration Guide.

9. Offramp Gateway

Offramp gateway overview

This function is used to convert an E-mail, received at this equipment as a relay station, into a Fax data and forward it to another Fax machine through a public telephone line. It is useful when you want to reduce communication cost by using both the Internet and public telephone lines. For example, when you want to send a document out of your city or overseas, the document can be sent as an E-mail to this equipment through the Internet, and then it will be forwarded to a target Fax machine as a Fax data through a public telephone line.

Tip

To use this function for e-STUDIO520/600/720/850, you need to install the following option: "Printer Kit (GM-1050) and Scanner Kit (GM-4010)" or "Printer/Scanner Kit (GM-2040)"

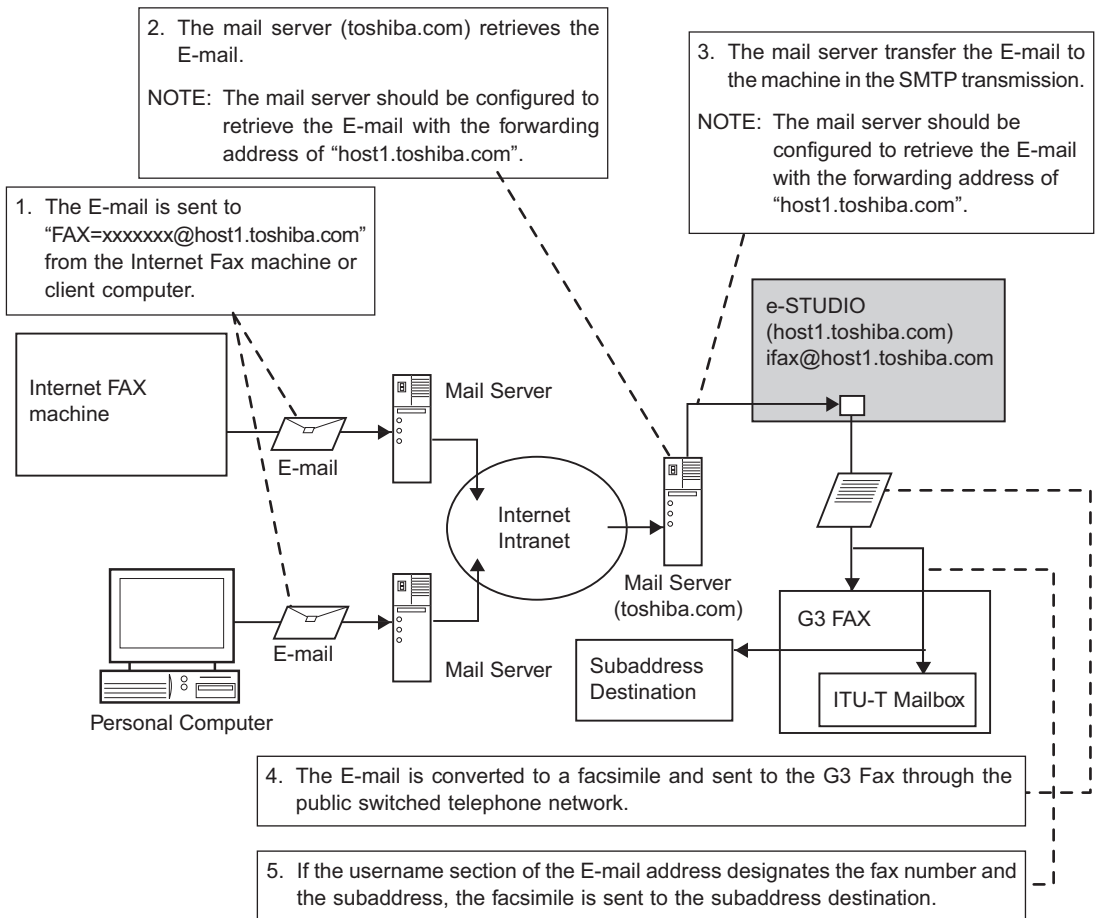

- P.114 "Transmitting data in offramp gateway"

Tip**To receive an E-mail using SMTP**

This equipment receives E-mails using a Simple Mail Transfer Protocol (SMTP) to enable the offramp gateway transmission. SMTP is a server protocol for sending E-mails from a client PC to a mail server or between servers.

When the SMTP server setting is enabled in the network setting of this equipment, this equipment can receive E-mails forwarded using SMTP.

To receive E-mails, this equipment is usually registered as a host machine. In this case, this equipment receives E-mails using POP3 server as the other client PCs do. To enable offramp gateway function, however, this equipment must receive E-mails forwarded using SMTP. Therefore this equipment should be registered as a mail server or some additional settings may be required depending on a mail server used. See the TopAccess Guide for details.

- Text data and TIFF format image data are the only file formats this equipment can receive. See the Scanning Guide for details.

5**Transmitting data in offramp gateway**

When you want to send an E-mail to this equipment with offramp gateway function or when you want to set this equipment as a relay station to perform an offramp gateway transmission, advise the sender of how to perform an offramp gateway transmission.

To set this equipment as a relay station to perform an offramp gateway transmission:

Send an E-mail to this equipment with an E-mail address including a Fax number of a relay destination. You can also attach a subaddress (mailbox subaddress).

- Sending to a Fax machine
FAX=xxxxxxx@FQDN
The Fax number of a relay destination comes at "xxxxxxx".
e.g.:
In case that the domain name (FQDN) of this equipment is "host1.toshiba.com" and the Fax number is "1212121212", the Fax should be sent at "FAX=1212121212@host1.toshiba.com".
- Sending to a subaddress
FAX=xxxxxxx/T33S=yyyy@FQDN
The Fax number of a relay destination comes at "xxxxxxx".
e.g.:
In case that the domain name (FQDN) of this equipment is "host1.toshiba.com", the Fax number is "1212121212", and the subaddress is "1234", the Fax should be sent at "FAX=1212121212/T33S=1234@host1.toshiba.com".

Tip

"T33S" in the above is a code which denotes a subaddress. When a Fax is transmitted at the subaddress of the Fax machine in the offramp gateway function, the Fax number and the subaddress number should be divided by a slash "/".

10. Save as File

This function is used to save transmitted Fax data to the shared folder of this device or a network folder you specify. Once the data is saved to the desired location, you can access the files using Windows Explorer or My Network Places.

- * To save a Fax data into a client PC, the network administrator has to make some settings in advance. See the TopAccess Guide for details.
- * The hard disk of this equipment may break down in rare cases. Be sure to back up the data in the shared folder of this equipment.

Tip

To use this function for e-STUDIO520/600/720/850, you need to install the following option: "Printer Kit (GM-1050) and Scanner Kit (GM-4010)" or "Printer/Scanner Kit (GM-2040)"

1 Place the original(s).

- P.26 "Setting originals"

2 Press the [FAX] button on the control panel.

3 Press the [FILE] button to enter the file menu, and then press the [SAVE AS FILE] button.



4 Press the [FILE NAME] button to enter the file name (maximum 45 letters) of the original to be saved, and then press the [ENTER] button.

STANDARD DESTINATION: 0000
READY

ADDRESS DESTINATION ADVANCED FILE

SAVE AS FILE

FILE NAME: DOC050411

MFP LOCAL: \\MFP850\FILE_SHARE\

PEI NOTE 1: [REDACTED]

PEI NOTE 2: [REDACTED]

FILE FORMAT: PDF(MULTI) PDF(SINGLE) TIFF(MULTI) TIFF(SINGLE)

CANCEL ENTER

- To enter letters, see the Operator's Manual for Basic Function.

DOC050411_

! " # \$ % & ' () = ~ | \ { } Back Space

* < > ? _ - ^ @ + | | ; : / \ ← →

Q W E R T Y U I O P

A S D F G H J K L

Z X C V B N M , . Shift Caps Lock

Space CANCEL ENTER Next

5 Select the location where the data is saved.

- [MFP LOCAL]: Select it when the data should be saved in the hard disk of this equipment. The data will be saved under the directory path shown on the menu.
- [REMOTE 1] and [REMOTE 2]: Select them when the data should be saved in the hard disk of a client PC through a server. The administrator has to make some settings in advance using the TopAccess function to select either of them. See the TopAccess Guide for details.

STANDARD DESTINATION: 0000
READY

ADDRESS DESTINATION ADVANCED FILE

SAVE AS FILE

FILE NAME: DOC050411

MFP LOCAL: \\MFP850\FILE_SHARE\

PEI NOTE 1: [REDACTED]

PEI NOTE 2: [REDACTED]

FILE FORMAT: PDF(MULTI) PDF(SINGLE) TIFF(MULTI) TIFF(SINGLE)

CANCEL ENTER

6 Select the file format.

- [PDF (MULTI)]: Select it when the data should be saved as a multiple-page PDF file.
 - [PDF (SINGLE)]: Select it when the data should be saved as a single-page PDF file.
 - [TIFF (MULTI)]: Select it when the data should be saved as a multiple-page TIFF file.
 - [TIFF (SINGLE)]: Select it when the data should be saved as a single-page TIFF file.
- * When the data is being saved, a folder called TXFAX folder is automatically created and the data is saved in this folder. When "TIFF (SINGLE)" or "PDF (SINGLE)" is selected, another folder with the file name entered in step 4 is automatically created and each page of the data is saved in this folder. The client PC can access the saved data by opening the shared folder in the hard disk of this equipment on the network.

STANDARD DESTINATION: 0000
READY

ADDRESS DESTINATION ADVANCED FILE

SAVE AS FILE

FILE NAME DOC050411 FILE FORMAT
MFP LOCAL \\MFP850\FILE_SHARE\ PDF(MULTI) PDF(SINGLE) TIFF(MULTI) TIFF(SINGLE)
PEI NOTE 1
PEI NOTE 2

CANCEL ENTER

5

7 Press the [ENTER] button after all the settings have been made.

8 Specify the remote Fax

- Entering the Fax number (☞ P.37 "Direct entry with digital keys")
- Selecting from address book (☞ P.38 "Address book entry")
- Selecting by group registration (☞ P.39 "Group entry")
- Selecting using multi-address transmission (☞ P.47 "Multi-address transmission")

9 Press the [START] button.



5

6. PRINTING LISTS AND REPORTS

1. Manually Printing Lists & Reports	120
2. Automatically Printing Lists & Reports	124
• Automatically printing lists & reports	124
• Setting the lists and reports output.....	125
3. Lists/Reports Samples	133

1. Manually Printing Lists & Reports

You can print the following lists and reports.

- * Lists and reports are printed on LT/A4-size paper.
If the equipment has run out of LT/A4-size paper, lists and reports will be printed on larger sized paper.
- **Transmission journal:**
List of transmissions. Outputs the latest 40 (or 120) transmissions.
Switching the number of communications output (📖 P.125 “Setting the (transmission/reception) journal output and its number”)
- **Reception journal:**
List of receptions. Outputs the latest 40 (or 120) receptions.
Switching the number of communications output (📖 P.125 “Setting the (transmission/reception) journal output and its number”)
- **Reservation list:**
List of the files in memory that are standing by to be sent.
- **Address book information:**
List of names, phone numbers of remote Faxes, E-mail address, SUB/SEP and SID/PWD entered in the address book.
To print out the list, see the [User Functions Guide].
- **Group numbers information:**
List of names and remote Faxes entered in a group. To print out the list, see the [User Functions Guide].
- **Function list:**
List of current system settings. To print out the list, see the [User Functions Guide].
- **ITU Mailbox list:**
List of the current status of mailboxes.

6

Printing transmission/reception journals

- 1 Press the [JOB STATUS] button on the control panel.

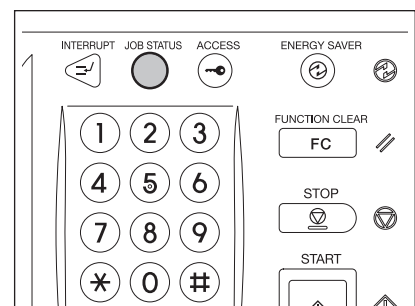

2 Press the [LOG] button to enter the log menu, and then press the [SEND] or [RECEIVE] button.

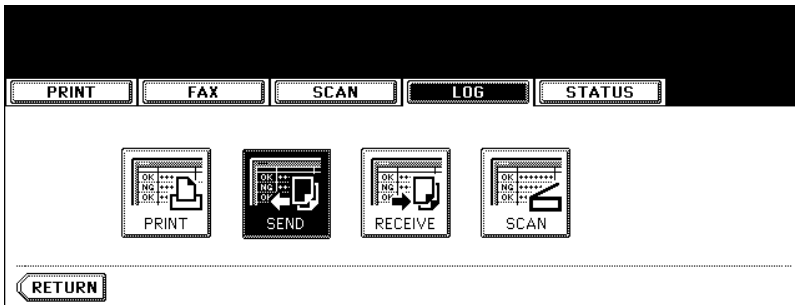

3 Press the [JOURNAL] button.

- The journals will be output.
- If the [JOURNAL] button is pressed with a file selected, the journal of the selected file for one transmission is output.

The screenshot shows the SEND LOG menu. At the top, the LOG button is highlighted. Below it is a table with the following data:

File No.	To	Date,Time	Pages	Status
005	USER01	04, 14:58	1	OK
004	USER01	04, 13:38	0	0050
003	23	04, 11:29	0	0050
002	USER01	04, 11:28	0	0050

At the bottom of the screen, there are buttons for RETURN, JOURNAL, and ENTRY. The JOURNAL button is highlighted. To the right of the buttons, it says "1/3" and a "Next" button.

Error code table

If an error occurs during communications, an error code is indicated in the transmission journal, reception journal or memory transmission journal.
See the following table for the remedy.

Error Code	Description	Remedy
0012	Original jam	Clear the jammed original.
0013	Door open	Firmly close the open door.
0020	Power interruption	Check the power interruption report.
0030	Reset	Transmission is cancelled. (The transmission is terminated by the jammed printing paper during the direct transmission.)
0033	Polling Error	Check polling options setup (Security code, etc.), and check if the polling document exists.
0042	Memory full	Make sure that there is sufficient memory before making the call again.
0050	Line busy	Retry communications.
0053	Security mismatch in relay or mail box transmission	Confirm the remote party's security code, system password, and your setup.
00B0 - 00E8	Communication Error	Retry communications.

Tip

If you encounter an error code not listed here, please repeat your communication. If this error recurs, please contact your service technician.

Printing reservation list

- 1 Press the [JOB STATUS] button on the control panel.
- 2 Press the [FAX] button, and then press the [RESERVATION LIST] button.

- The reservation list is output.

File No.	To	Date, Time	Pages	Status
003	23	04, 14:47	1	Line1
002	USER01	04, 14:57	1	Wait

1/1

Printing ITU mailbox list

- 1 Press the [FAX] button on the control panel.

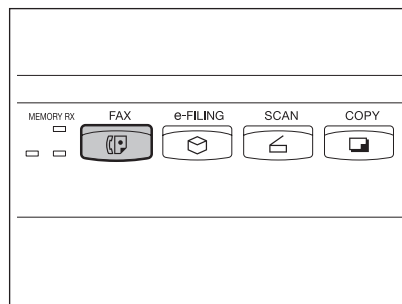

- 2 Press the [ADVANCED] button to enter the advanced menu, and then press the [ITU MAILBOX LIST] button.

- The ITU mailbox list is output.

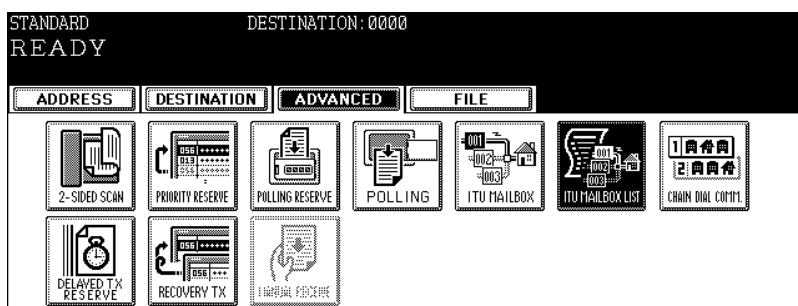

2. Automatically Printing Lists & Reports

Automatically printing lists & reports

Reports are automatically output if the conditions in the setting of the lists & reports output (📖 P.125 “Setting the lists and reports output”) are satisfied.

* Lists and reports are printed on LT/A4-size paper.

If LT/A4-size paper has run out, lists and reports will be printed on larger sized paper.

- **Transmission journal:**
Printed after every 40 (or 120) transmissions.
 - **Reception journal:**
Printed after every 40 (or 120) receptions.
 - **Memory transmission report**
After memory transmission has ended, this report is output. The reduced transmission document can be added by using “PRINT 1st PAGE IMAGE?”.
 - **Direct transmission report:**
After direct transmission has ended, this report is output.
 - **Multi transmission report:**
After multi-address transmission has ended, this report is output. The reduced transmission document can be added by using “PRINT 1st PAGE IMAGE?”.
 - **Polling report:**
After multi-polling RX has ended, this report is output.
 - **Relay transmission originator terminal report:**
When this equipment is setup as a relay originator, a status report concerning the initial transmission to the relay stations is output. The reduced transmission document can be added by using “PRINT 1st PAGE IMAGE?”.
 - **Relay transmission relay station report:**
When this equipment is setup as a relay station, a status report of the transmission to the relay destinations is output. The reduced transmission document can be added by using “PRINT 1st PAGE IMAGE?”.
 - **Relay transmission end terminal report:**
When this equipment is setup as a relay station, a report providing the final outcome of the relay transmission is transmitted to the relay originator. The reduced transmission document can be added by using “PRINT 1st PAGE IMAGE?”.
 - **Mailbox reception report:**
Printed when an original is received in a confidential or bulletin board.
 - **Relay station report:**
Printed when an original is received in a relay mailbox.
 - **Power failure list:**
The list of the jobs which were erased will be output if there is something wrong with the contents of the image memory when the main power switch is turned ON after a power failure during Fax communication.
-

Setting the lists and reports output

Setting the (transmission/reception) journal output and its number

- AUTO: ON, OFF
Setting whether the transmission/reception journal should be output automatically.
- Transmission journal: 40,120
Setting the number of communications on the transmission journal as 40 or 120.
- Reception journal: 40,120
Setting the number of communications on the reception journal as 40 or 120.

1 Press the [USER FUNCTIONS] button on the control panel.

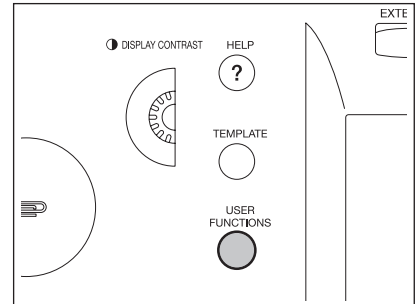

2 Press the [ADMIN] button and then press the [PASSWORD] button.

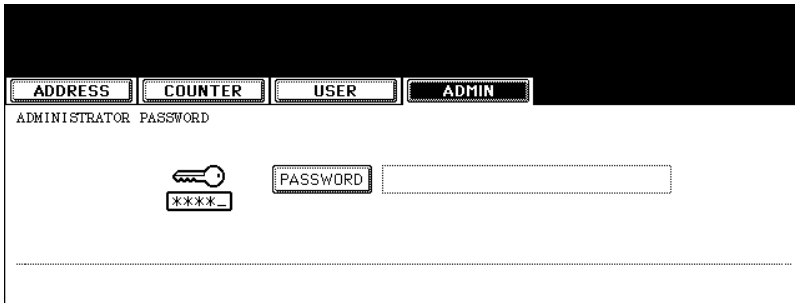

3 Enter the administrator password (6 to 10 digits), and then press the [ENTER] button.

- Ask your administrator to the administrator password.

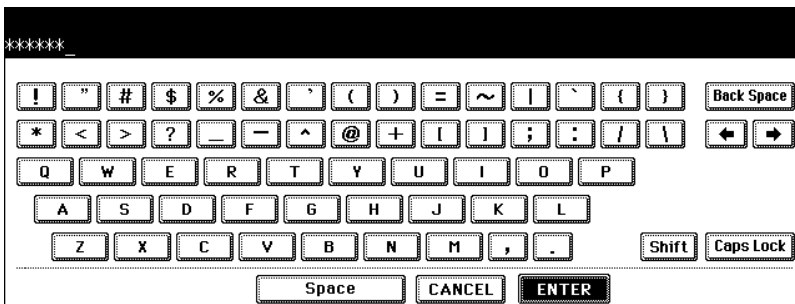

4 Press the [LIST/REPORT] button.



5 Press the [REPORT SETTING] button.

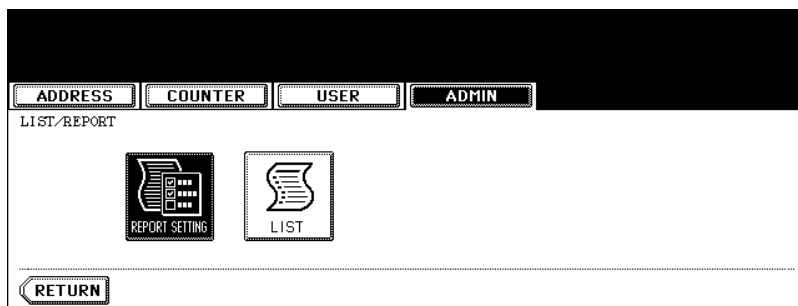

6 Press the [JOURNAL] button.

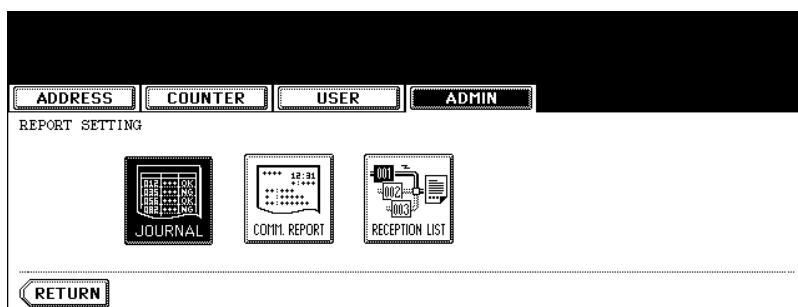

6

7 Press the [ON] or [OFF] button.

- The default setting is ON.

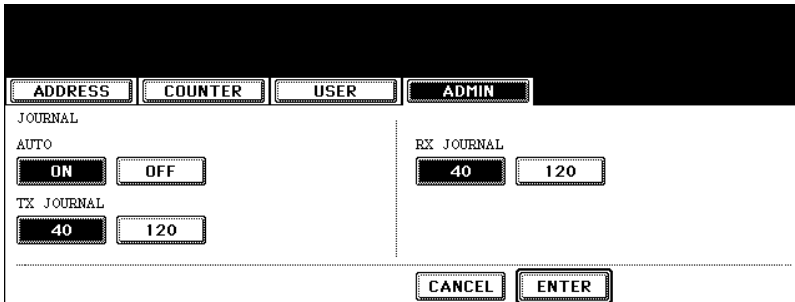

The screenshot shows a control panel with four tabs: ADDRESS, COUNTER, USER, and ADMIN. The ADMIN tab is selected. Under the JOURNAL heading, there are two sections: AUTO and TX JOURNAL. The AUTO section has two buttons: ON (highlighted) and OFF. The TX JOURNAL section has two buttons: 40 and 120. The RX JOURNAL section has two buttons: 40 and 120. At the bottom, there are CANCEL and ENTER buttons.

8 Select the desired number (either 40 or 120 communications).

- The default setting is 40.

9 Press the [ENTER] button.

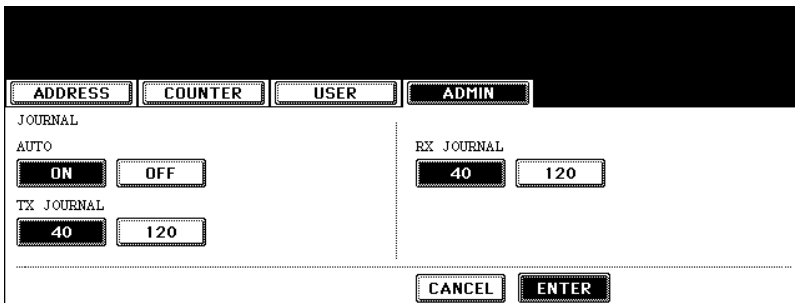

The screenshot shows the same control panel as in step 7. In the RX JOURNAL section, the '40' button is now highlighted, indicating it has been selected. The 'ON' button in the AUTO section is no longer highlighted. The 'ENTER' button at the bottom is now highlighted, indicating it should be pressed.

6

Setting the communication report output

The following conditions of the communication report output can be set.

MEMORY TX: OFF, ALWAYS, ON ERROR
DIRECT TX: OFF, ALWAYS, ON ERROR
MULTI TX: OFF, ALWAYS, ON ERROR
POLLING: OFF, ALWAYS, ON ERROR
RELAY ORIGINATOR: OFF, ALWAYS, ON ERROR
RELAY STATION: OFF, ALWAYS, ON ERROR
RELAY DESTINATION: OFF, ALWAYS, ON ERROR

If the [ALWAYS] button is selected: The report is output after every communication is completed.

If the [ON ERROR] button is selected: The report is output when a communication error has occurred.

If the OFF button is selected. The report is not output.

1 Press the [USER FUNCTIONS] button on the control panel.

2 Press the [ADMIN] button and then press the [PASSWORD] button.

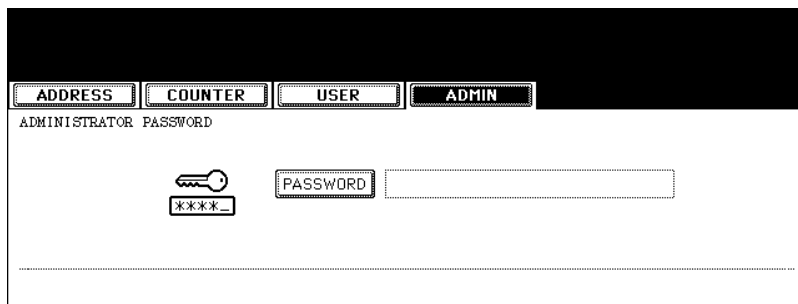

3 Enter the administrator password (6 to 10 digits), and then press the [ENTER] button.

- Ask your administrator to the administrator password.

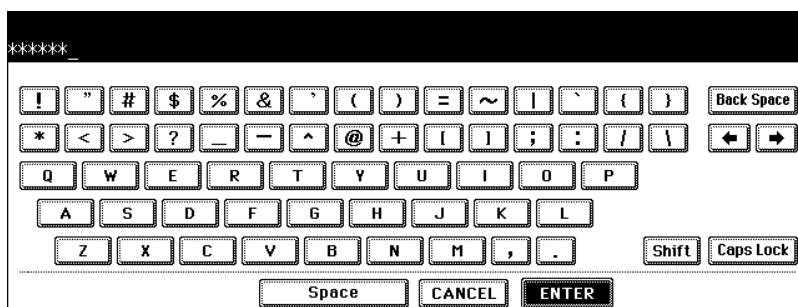

4 Press the [LIST/REPORT] button.



5 Press the [REPORT SETTING] button.

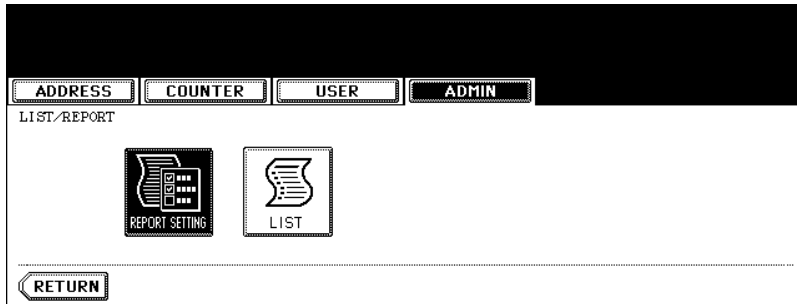

6 Press the [COMM. REPORT] button.

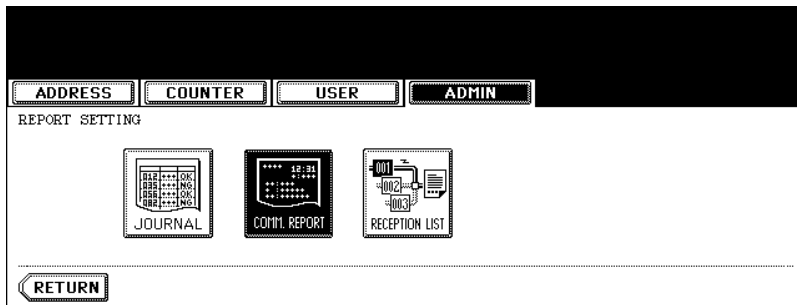

6

7 Press the desired buttons for each item.

- If the button for the desired function is not shown, press the [Next] button to switch screens.
- The icons highlighted in the screen below are the default settings. However, the [ALWAYS] buttons are selected for all reports other than "RELAY DESTINATION" as a default setting for European versions.

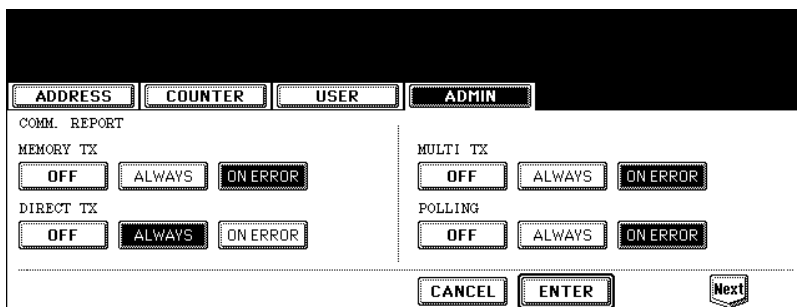

- If you select the [ALWAYS] or [ON ERROR] button for the MEMORY TX, MULTI TX, RELAY ORIGINATOR, RELAY STATION and RELAY DESTINATION, "PRINT 1st PAGE IMAGE?" appears. Press the [YES] or [NO] button.

8 Press the [ENTER] button.

The screenshot shows the 'ADMIN' menu with the following options:

- ADDRESS
- COUNTER
- USER
- ADMIN (highlighted)

Under 'COMM. REPORT':

- RELAY ORIGINATOR: OFF, ALWAYS, ON ERROR
- RELAY DESTINATION: OFF, ALWAYS, ON ERROR

Under 'RELAY STATION':

- RELAY STATION: OFF, ALWAYS, ON ERROR

At the bottom, there are buttons for CANCEL, ENTER, and a 'Prev' button with a left arrow.

Setting the reception list output

- LOCAL: ON, OFF
Setting whether the mailbox reception report should be printed when the original is stored in the local mailbox.
- REMOTE: ON, OFF
Setting whether the mailbox reception report should be printed when the original is received from the remote Fax to the local mailbox.
- RELAY STATION: ON, OFF
Setting whether the mailbox reception report should be printed when the multi-address relay transmission is received from the multi-address relay originator.

1 Press the [USER FUNCTIONS] button on the control panel.

2 Press the [ADMIN] button and then press the [PASSWORD] button.

The screenshot shows the 'ADMINISTRATOR PASSWORD' screen with the following elements:

- ADDRESS
- COUNTER
- USER
- ADMIN (highlighted)

Below the menu is the text 'ADMINISTRATOR PASSWORD'.

There is a key icon next to a 'PASSWORD' label and a text input field. The input field contains '****_'.

3 Enter the administrator password (6 to 10 digits), and then press the [ENTER] button.

- Ask your administrator to the administrator password.

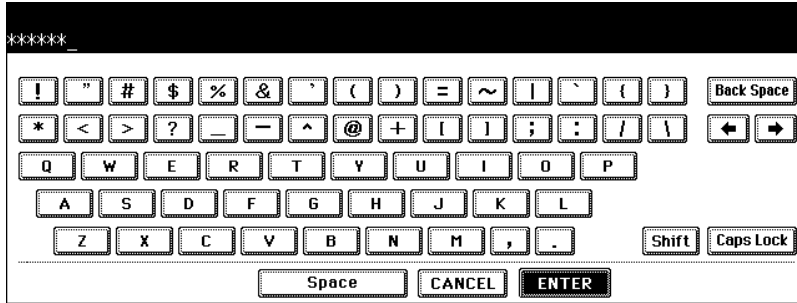

4 Press the [LIST/REPORT] button.

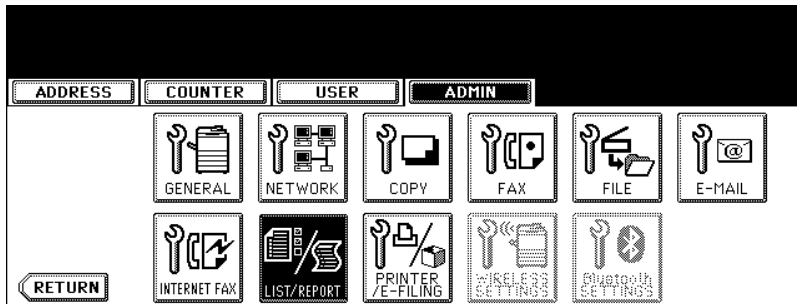

5 Press the [REPORT SETTING] button.

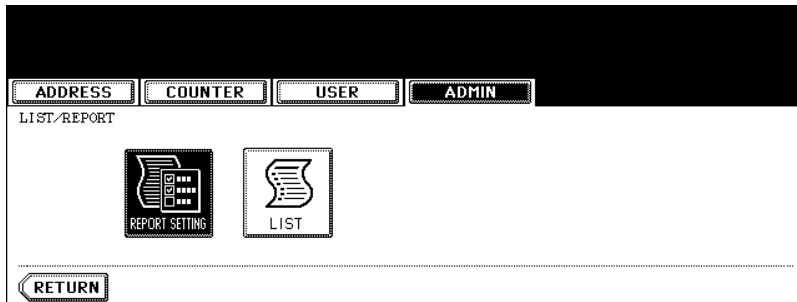

6 Press the [RECEPTION LIST] button.

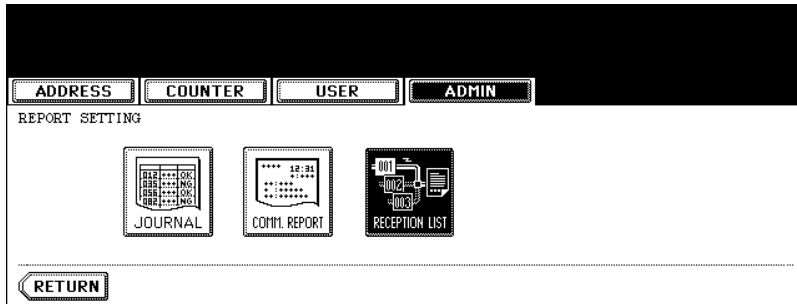

7 Press the desired buttons for each item.

- The icons highlighted in the screen below are the default settings. However, the default setting for European versions is as follows:
RELAY STATION: ON
LOCAL: OFF
REMOTE: ON

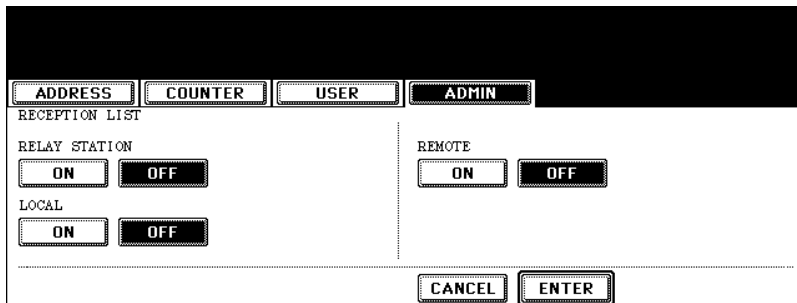

8 Press the [ENTER] button.

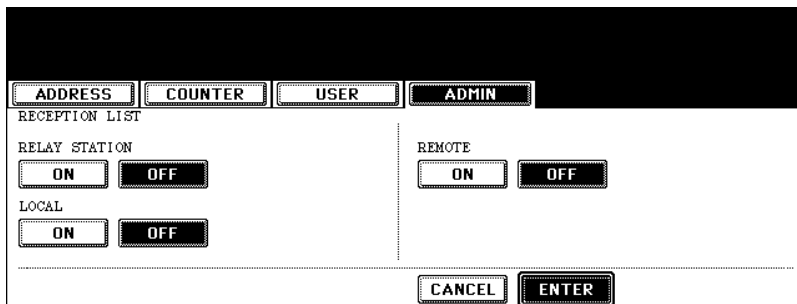

3. Lists/Reports Samples

Transmission journal (Manually and automatically output)

This is the list of the transmission-related information such as communication results and remote Fax numbers.

- Output information for the last 40 or 120 communications can be confirmed. Switching the number of communications output. (📖 P.125 “Setting the (transmission/reception) journal output and its number”)
- The mark ◆ in the “TO” column is appended when the 2nd TEL NUMBER is used for transmission.
- If any errors occur during transmission, the error code is displayed under the “STATUS” column. (📖 P.122 “Error code table”)

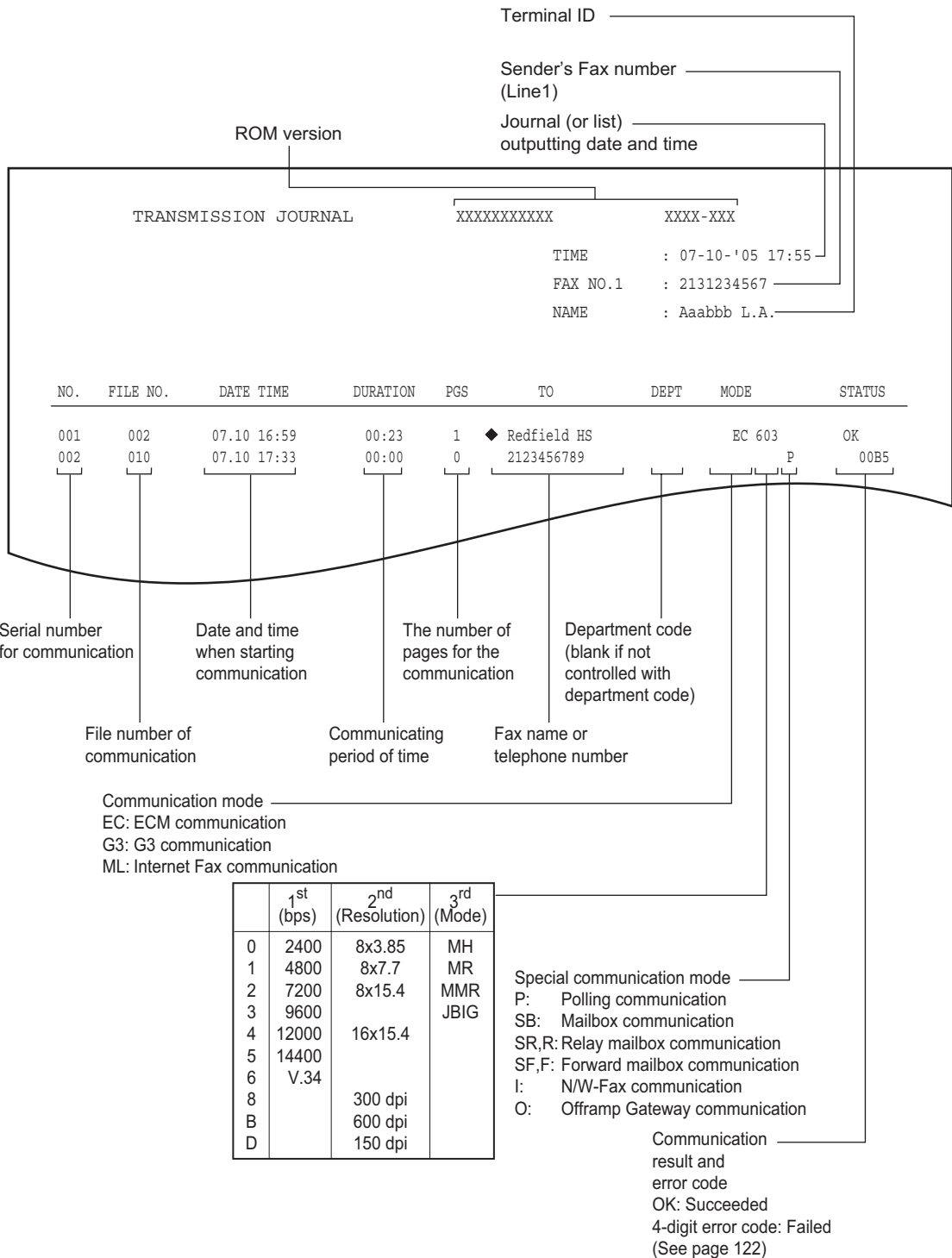

6

Reception journal (Manually and automatically output)

This is the list of the reception-related information such as communication results and remote Fax numbers.

- Output information for the last 40 or 120 communications can be confirmed. Switching the number of communications output. (📖 P.125 “Setting the (transmission/reception) journal output and its number”)
- If any errors occur during transmission, the error code is displayed under the “STATUS” column. (📖 P.122 “Error code table”)

RECEPTION JOURNAL		XXXXXXXXXX			XXXX-XXX			
					TIME	:	07-10-'05 17:55	
					FAX NO.1	:	2131234567	
					NAME	:	Aaabbb L.A.	
NO.	FILE NO.	DATE TIME	DURATION	PGS	FROM	DEPT	MODE	STATUS
001	003	07.10 14:23	00:00	0	Aaabbb USA HQ			NG 00B1
002	007	07.10 17:20	00:32	1	3109998888		EC 603	OK

Reservation list (Manually output)

This is the list of the jobs that are standing by for transmission and recovery transmission.

- The mark ☎ on the "TO" refers to a manually input telephone number.
- The mark G on the "TO" refers to a pre-programmed group.

RESERVATION LIST						
					TIME	: 07-10-'05 18:41
					FAX NO.1	: 2131234567
					NAME	: Aaabbb L.A.
<u>TX/RX</u>						
<u>FILE NO.</u>	<u>DATE</u>	<u>TIME</u>	<u>FUNCTION</u>	<u>PGS</u>	<u>TO</u>	<u>DELAY TIME</u>
017	07.10	18:41	MULTI TX	1	G ABC EXPRESS	
<u>RECOVERY TX</u>						
<u>FILE NO.</u>	<u>DATE</u>	<u>TIME</u>	<u>FUNCTION</u>	<u>PGS</u>	<u>TO</u>	<u>DELAY TIME</u>
013	07.10	18:01	MULTI TX	1	☎2153334444	
<u>PC JOB</u>						
<u>FILE NO.</u>	<u>DATE</u>	<u>TIME</u>	<u>FUNCTION</u>	<u>PGS</u>	<u>TO</u>	<u>DELAY TIME</u>
003	07.10	17:40	MULTI TX	2	Ccdddd CORPORATION	

Mailbox/relay box report (Manually output)

This is the report of the current status of the mailboxes.

MAILBOX/RELAY BOX REPORT							
					TIME	: 07-10-'05 18:00	
					FAX NO.1	: 2131234567	
					NAME	: Aaabbb L.A.	
<u>MAIL BOX</u>							
BOX NO.	BOX TYPE	PGS	FILE NO.	DATE TIME	FROM		
11222	BULLETIN BD.						
11231	CONFIDENTIAL	1	008	07.10 17:24	LOCAL		
<u>RELAY</u>							
BOX NO.	END STATION				REPLY TO NUMBER		
12345	ADDRESS	001	002	003	004	005	12345
	GROUP	001	002				
<u>FORWARD/INBOUND FAX (TSI)</u>							
BOX NO.	AGENT	DESTINATION					
22222	E-MAIL	To: ADDRESS: <input checked="" type="checkbox"/> 001					
		GROUP : <input checked="" type="checkbox"/> 001					
		Cc: ADDRESS: <input checked="" type="checkbox"/> 002 <input checked="" type="checkbox"/> 003					
		GROUP : <input checked="" type="checkbox"/> 002					

Memory transmission report (Automatically output)

After memory transmission has ended, this report is output. A reduced image of the first page of the document transmitted is appended on the report.

- This will be output "ON ERROR" or "ALWAYS". (📖 P.127 "Setting the communication report output")
- The mark **◆** on the "TO" is appended when the 2nd TEL NUMBER is used for transmission.
- The mark **☎** on the "TO" refers to a manually input the telephone number.
- The (ITU MAILBOX:) on the "FILE NO." refers to a communication using a mailbox.
- The (STORED TIME:) on the "END TIME" shows the data storing time of when the recovery transmission has been set.
- If an error occurs during memory transmission, the error code will be indicated on the "STATUS". (📖 P.122 "Error code table")

MEMORY TRANSMISSION REPORT

TIME : 07-10-'05 17:48
 FAX NO.1 : 2131234567
 NAME : Aaabbb L.A.

FILE NO. : 004 (ITU MAILBOX : 12345)
 DATE : 07.10 17:11
 TO : **◆** ABC EXPRESS
 DOCUMENT PAGES : 1
 START TIME : 07.10 17:13
 END TIME : 07.10 17:14 (STORED TIME : 07.10 23:14)
 PAGES SENT : 0
 STATUS : 0050

*** TX FAILURE NOTICE ***

FILE NO. : 005 (ITU MAILBOX : 12345)
 DATE : 07.10 17:25
 TO : **☎** 2221234555
 DOCUMENT PAGES : 1
 START TIME : 07.10 17:30
 END TIME : 07.10 17:31 (STORED TIME : 07.10 23:31)
 PAGES SENT : 1
 STATUS : OK

Transmission report (Automatically output)

After direct transmission has ended, this report is output.

- This will be output "ON ERROR" or "ALWAYS". (📖 P.127 "Setting the communication report output")
- If an error occurs during direct transmission, the error code will be indicated on the "STATUS". (📖 P.122 "Error code table")

TRANSMISSION REPORT		XXXXXXXXXX	XXXX-XXX					
		TIME	: 07-10-'05 17:55					
		FAX NO.1	: 2131234567					
		NAME	: Aaabbb L.A.					
<u>NO.</u>	<u>FILE NO.</u>	<u>DATE TIME</u>	<u>DURATION</u>	<u>PGS</u>	<u>TO</u>	<u>DEPT</u>	<u>MODE</u>	<u>STATUS</u>
002	007	07.10 17:20	00:32	1	3109998888		EC C03	OK

Multi transmission report (Automatically output)

After multi-address transmission has ended, this report is output. A reduced image of the first page of the document transmitted is appended on the report.

- This will be output "ON ERROR" or "ALWAYS". (P.127 "Setting the communication report output")
- The mark ◆ on the "TO" is appended when the 2nd TEL NUMBER is used for transmission.
- The mark ☎ on the "FAX NUMBER" refers to a manually input telephone number.
- The (STORED TIME:) next to the "END TIME" shows the data storing time of when the recovery transmission has been set.

```

MULTI TRANSMISSION REPORT

                                     TIME           : 07-10-'05 18:17
                                     FAX NO.1       : 2131234567
                                     NAME            : Aaabbb L.A.

FILE NO.          : 013
DATE              : 07.10 18:01
DOCUMENT PAGES   : 1
START TIME       : 07.10 18:01
END TIME         : 07.10 18:17 (STORED TIME : 07.11 00:17)
SUCCESSFUL
ADDRESS BOOK
001             ◆ Aaabbb ADMIN

UNSUCCESSFUL

ADDRESS BOOK           PAGES SENT
003             ☎ Cccddd USA HQ           0

```

Polling report (Automatically output)

After multi-polling reception has ended, this report is output.

- This will be output "ON ERROR" or "ALWAYS". (☞ P.127 "Setting the communication report output")
- The mark ☎ on the "FAX NUMBER" refers to a manually input telephone number.

POLLING REPORT		TIME	: 07-10-'05 18:18
		FAX NO.1	: 2131234567
		NAME	: Aaabbb L.A.
FILE NO.	: 014		
DATE	: 07.10 18:02		
START TIME	: 07.10 18:17		
END TIME	: 07.10 18:18		
SUCCESSFUL			
ADDRESS BOOK			
001	Cccddd ADMIN		
UNSUCCESSFUL			
FAX NUMBER			
	☎2139998888		
NOT AVAILABLE			

Mailbox reception report (Automatically output)

This report is output when an original is received in a confidential or bulletin board.

MAILBOX RECEPTION REPORT	
	TIME : 07-10-'05 18:22
	FAX NO.1 : 2131234567
	NAME : Aaabb L.A.
FILE NO.	: 016
DATE	: 07.10 18:22
BOX NUMBER	: 12345
BOX TYPE	: CONFIDENTIAL
DOCUMENT PAGES	: 1 (TOTAL 2)
FROM	: LOCAL

6

Relay station report (Automatically output)

This report is output when an original is received in a relay mailbox.

RELAY STATION REPORT	
	TIME : 07-10-'05 13:33
	FAX NO.1 : 2131234567
	NAME : Aaabb L.A.
FILE NO.	: 734
DATE	: 07.10 13:33
RELAY BOX	: 777
DOCUMENT PAGES	: 1
FROM	: 214

Relay transmission originator terminal report (Automatically output)

When this equipment is setup as a relay originator, the report of the transmission to the relay stations is output.

- This will be output "ON ERROR" or "ALWAYS". (📖 P.127 "Setting the communication report output")
- The mark 📞 on the "TO" refers to a manually input telephone number.

RELAY TX ORIG. TERMINAL REPORT

TIME : 07-10-'05 18:22
FAX NO.1 : 2131234567
NAME : Aaabbb L.A.

FILE NO. : 016
DATE : 07.10 18:22
TO : 📞2139998888
RELAY BOX : 12345
DOCUMENT PAGES : 1
START TIME : 07.10 18:22
END TIME : 07.10 18:22
PAGES SENT : 1
STATUS : OK

Relay transmission relay station report (Automatically output)

When this equipment is setup as a relay station, the report of the transmission to the relay destinations is output. A reduced image of the first page of the document transmitted is appended on the report.

- This will be output "ON ERROR" or "ALWAYS". (P.127 "Setting the communication report output")
- The mark ◆ on the "TO" is appended when the 2nd TEL NUMBER is used for transmission.

```

RELAY TX RELAY STATION REPORT

                                     TIME           : 07-10-'05 14:46
                                     FAX NO.1       : 2131234567
                                     NAME           : Aaabbb L.A.

FILE NO.           : 013
DATE              : 07.10 14:45
DOCUMENT PAGES    : 3
FROM              : 7141234567
START TIME       : 07.10 14:45
END TIME         : 07.10 14:46
RELAY BOX        : 12345
SUCCESSFUL
GROUP NUMBER
  002 USA 1      ADDRESS BOOK ◆001
  005 ASIA 1
UNSUCCESSFUL
ADDRESS BOOK
  001 Cccddd ADMIN
                                     PAGE SENT
                                     0

```

Relay transmission end terminal report (Automatically output)

When this equipment is setup as a relay station, the report of the transmission to the relay destinations is transferred to the destination registered. A reduced image of the first page of the document transmitted is appended on the report.

- This will be output "ON ERROR" or "ALWAYS". (📖 P.127 "Setting the communication report output")

```
RELAY TX END TERMINAL REPORT

                                     TIME           : 07-10-'05 14:46
                                     FAX NO.1       : 2131234567
                                     NAME           : Aaabbb L.A.

FILE NO.           : 013
DATE              : 07.10 14:45
DOCUMENT PAGES    : 3
FROM              : 7141234567
START TIME       : 07.10 14:45
END TIME         : 07.10 14:46
RELAY BOX        : 12345
SUCCESSFUL
ADDRESS BOOK
  005           XYZ CORPORATION

UNSUCCESSFUL
ADDRESS BOOK
  001           Cccddd ADMIN

                                     PAGES SENT
                                     0
```

Power failure list (Automatically output)

A list of the jobs which were erased will be output if there is something wrong with the contents of the image memory when the main power switch is turned ON after a power failure during Fax communication.

POWER FAILURE LIST

TIME : 07-10-'05 17:53
 FAX NO.1 : 2131234567
 NAME : Aaabbb L.A.

TX/RX

<u>FILE NO.</u>	<u>FUNCTION</u>
044	POLLING RX
045	MULTI TX

MEMORY RECEPTION

<u>FILE NO.</u>
029

PC JOB

<u>FILE NO.</u>	<u>FUNCTION</u>
049	SINGLE TX
050	MULTI TX

7. REGISTERING AND SETTING ITEMS

1. Setting the Initial Transmission Mode	148
2. Registering the Terminal ID.....	150
3. Setting the Reception Mode.....	155
4. Setting RX Printing.....	158
• Setting RX printing	158
• Setting duplex printing.....	161
• Setting the rotate sort (Alternation)	164
5. Setting Recovery Transmission	166

1. Setting the Initial Transmission Mode

Set the initial settings for the original transmission conditions and transmission type. When you send an original without changing the original conditions and transmission mode settings, the original is sent with the initial setting values.

- **Resolution:** STANDARD, FINE, U-FINE
- **MODE (Original mode)** TEXT, TEXT/PHOTO, PHOTO
- **Exposure:** AUTO, MANUAL (adjustable in 11 steps)
- **Transmission type:** MEMORY TX, DIRECT TX
- **TTI recording (Setting is not available in all product markets):** ON, OFF
You can send originals appended with a terminal ID preset to your equipment.
You can set this terminal ID in either of the memory TX or direct TX modes.
Entering the terminal ID "2.REGISTERING THE TERMINAL ID"
(📖 P.150 "2.Registering the Terminal ID")
- **RTI recording:** ON, OFF
You can print the received originals appended with time received and a remote Fax ID information (if provided).
- **ECM (Error Correction Mode):** ON, OFF (📖 P.29 "4.Setting the Transmission Conditions")

1 Press the [USER FUNCTIONS] button on the control panel.

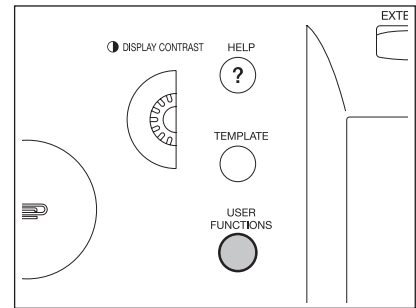

2 Press the [USER] button to enter the user menu, and then press the [FAX] button.

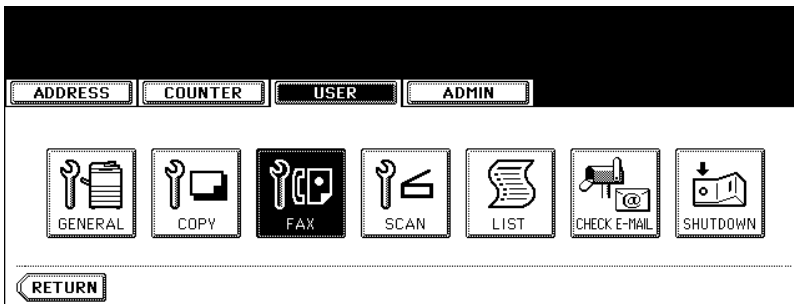

3 Press the desired buttons for each item.

- The screen below shows the default setting.
- Press the [Next] or [Prev] button to switch the screens as required.

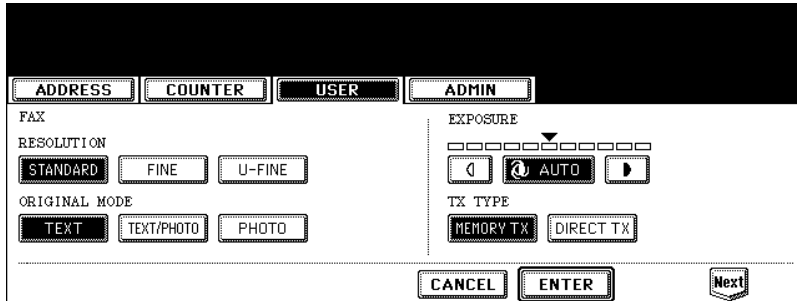

4 Press the [ENTER] button.

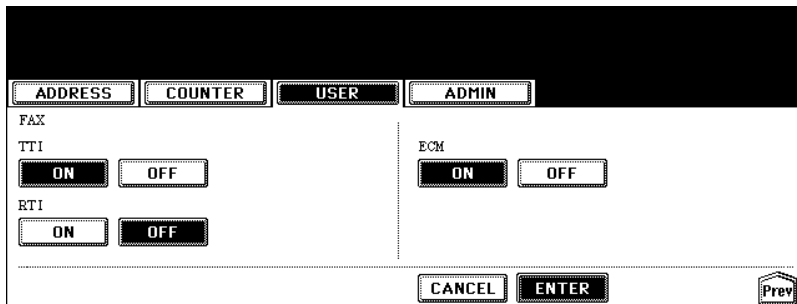

2. Registering the Terminal ID

If you register the ID name in advance, you can print sender information on the leading edge of originals that are transmitted and receiver information on the trailing edge of originals that are received.

- Details to register:
 - ID name (max. 20 characters)
 - ID number (max. 20-digit number)
 - Printing of international code (ON/OFF)

In compliance with FCC regulations (P.3 “NOTICE TO USERS”), this facsimile places your company’s name, facsimile telephone number and date & time on the top of all transmitted documents. This feature enables remote parties to easily identify your documents and the time of transmission.

(Example of how Sender Information is printed on originals received by the remote Fax)

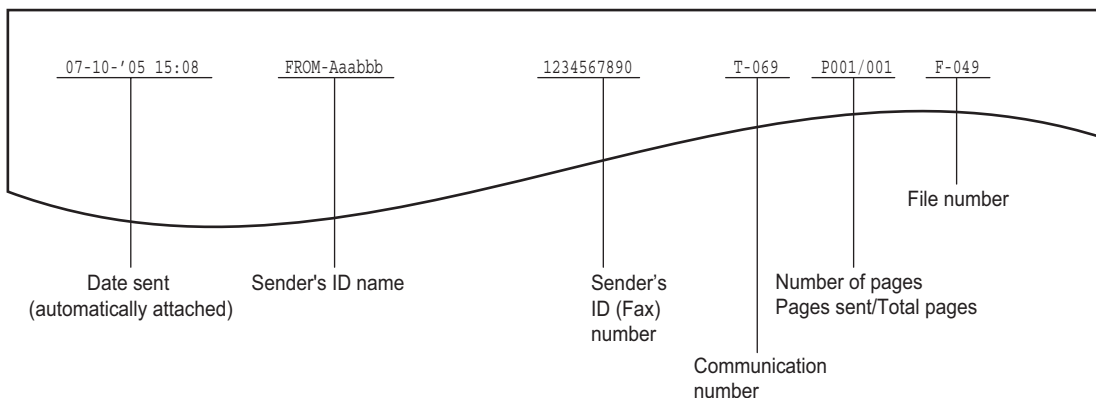

7

Tip

Sender information is printed about 5 mm from the top edge of the transmitted original.

(Example of how Receiver Information is printed on originals you receive)

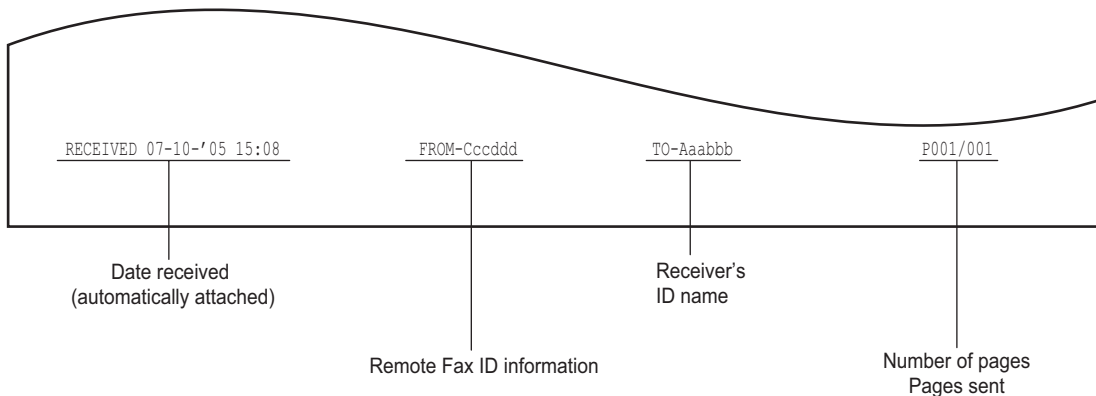

Tip

Receiver information is printed about 5 mm from the bottom edge of the received original.

1 Press the [USER FUNCTIONS] button on the control panel.

2 Press the [ADMIN] button and then the [PASSWORD] button.

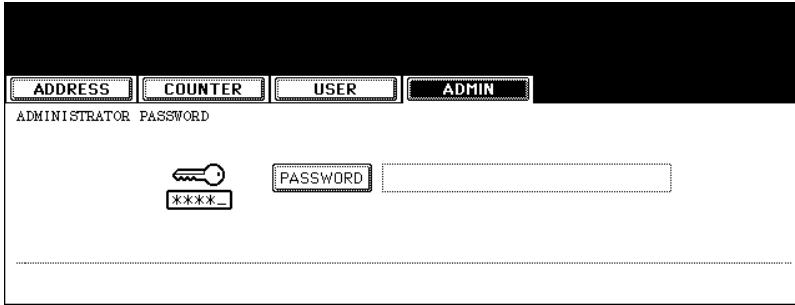

3 Enter the administrator password (6 to 10 digits), and then press the [ENTER] button.

- Ask your administrator for the administrator password.

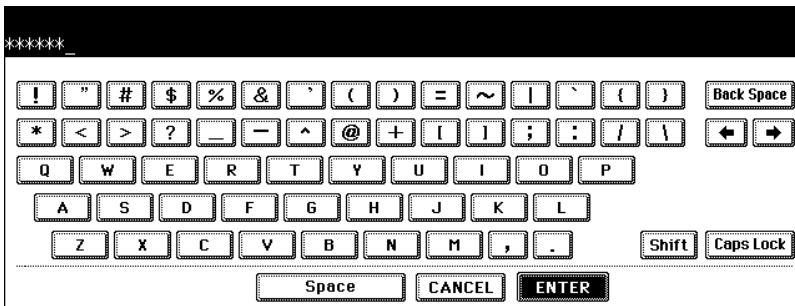

4 Press the [FAX] button.

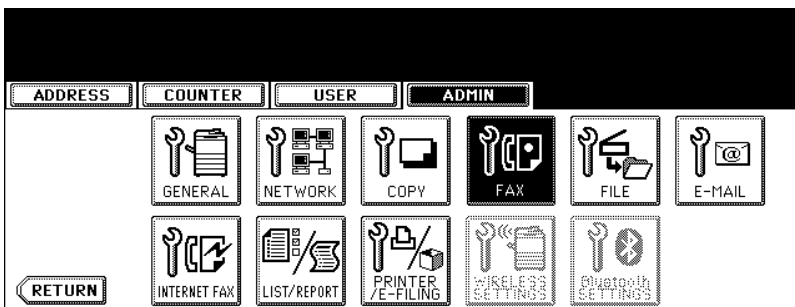

5 Press the [TERMINAL ID] button.

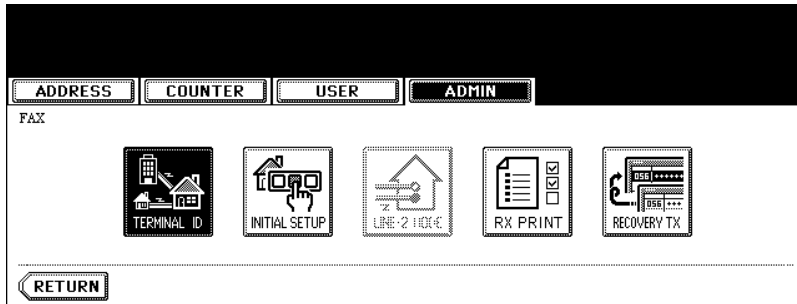

6 Press the [ID NAME] button and enter the ID name in the letter entry screen (up to 20 characters). When you have finished entering the letters, press the [ENTER] button.

- Entering letters, see the [Operator's Manual for Basic Function].

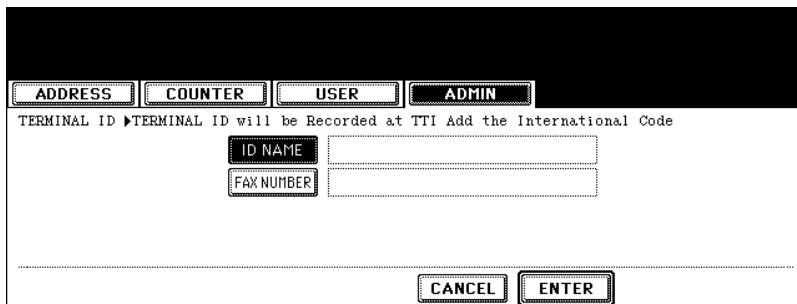

7

7 Press the [FAX NUMBER] button.

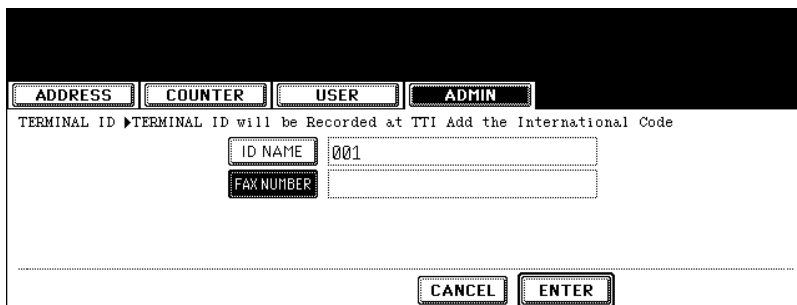

8 Press either the [YES] or [NO] button for adding the international code.

ADDRESS COUNTER USER ADMIN

Add the International Code

YES NO

CANCEL

Tip

If you add the international code (your country/region code) in advance, you can let the remote Fax know your country/region when communicating overseas.

<Example> Registration by adding international code in the terminal ID (234-567-8901).

+12345678901

If the area code starts from "0", "0" will be omitted.

International code

If you press the [YES] button in step 7, "+" is added automatically.

9 Key in the terminal number, and then press the [ENTER] button.

Tip

To enter a pause "-", press the [MONITOR/PAUSE] button.

22_

Enter the fax/tel number

Back Space

← →

CANCEL ENTER

10 Check the settings. If they are correct, press the [ENTER] button to complete entry.

- To change the settings, press the [ID NAME] or [FAX NUMBER] button again.

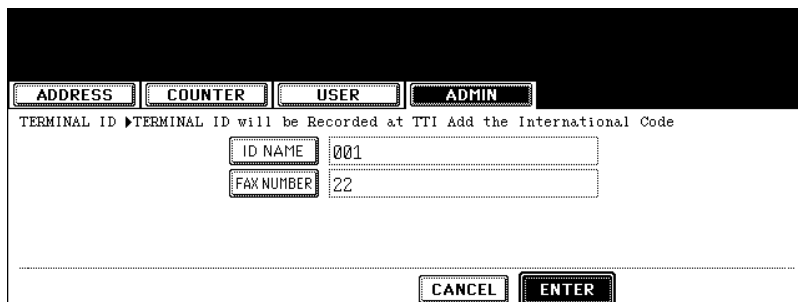

ADDRESS COUNTER USER ADMIN

TERMINAL ID > TERMINAL ID will be Recorded at TTI Add the International Code

ID NAME 001

FAX NUMBER 22

CANCEL ENTER

3. Setting the Reception Mode

Set reception mode such as the volume settings and line-related items.

- **Reception mode**
AUTO, MANUAL
- **Monitor tone volume**
Adjustable 0-7 steps (0: tone OFF)
The “monitor tone” refers to the line monitor tone when the [MONITOR/PAUSE] button is pressed.
- **Reception completion tone volume**
Adjustable 0-7 steps (0: tone OFF)
The reception “completion tone” refers to the tone made by the equipment upon printing a Fax reception. It will be heard after each Fax reception has printed.
- **Dial type (Line 1)**
DP, MF (not available for the European version)
There are 2 types of telephone lines: Dial pulse lines (DP) and multi frequency lines (MF). Change the telephone line setting to match the type of line you are using, when you first install the system or you change the connected telephone line.

1 Press the [USER FUNCTIONS] button on the control panel.

2 Press the [ADMIN] button and then the [PASSWORD] button.

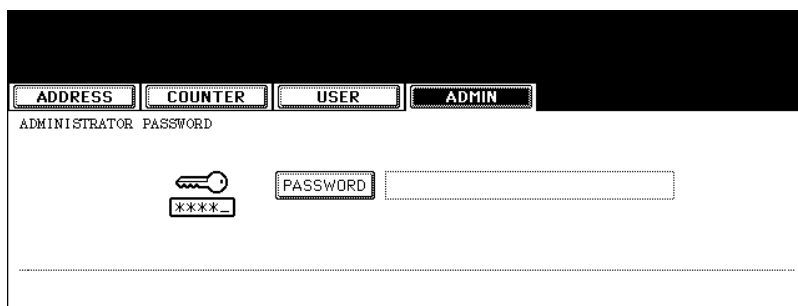

3 Enter the administrator password (6 to 10 digits), and then press the [ENTER] button.

- Ask your administrator for the administrator password.

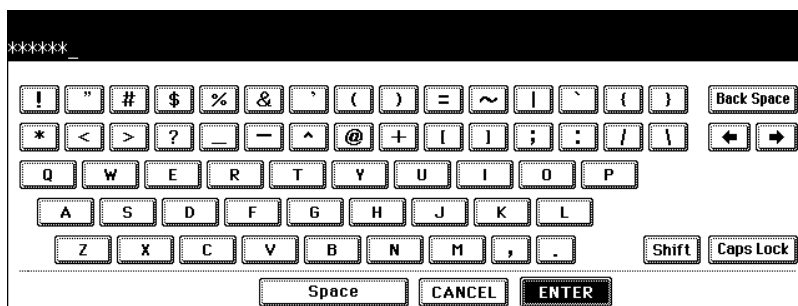

4 Press the [FAX] button.



5 Press the [INITIAL SETUP] button.

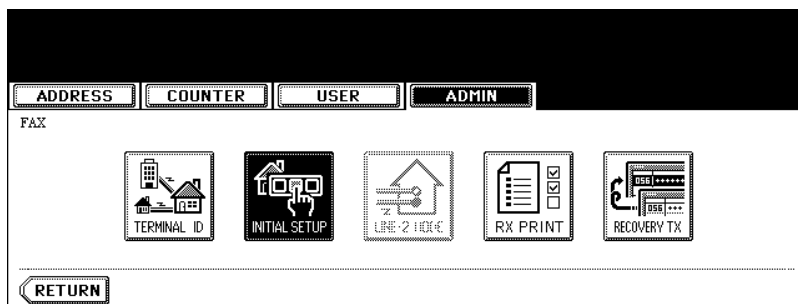

6 Press the desired buttons for each item.

- Press the [Prev] or [Next] button to switch the screens.
- The screen below shows the default settings.
- With the monitor tone volume, you can adjust the volume level used when the [MONITOR/PAUSE] button on the control panel is pressed.
- With the reception completion tone volume setting, you can adjust the volume level of the Fax reception end of print tone.
- To adjust the volume, press the [◀] or [▶] buttons. Pressing the [▶] button raises the volume, while pressing the [◀] button lowers it (When a tone is set to "0", there is no sound).

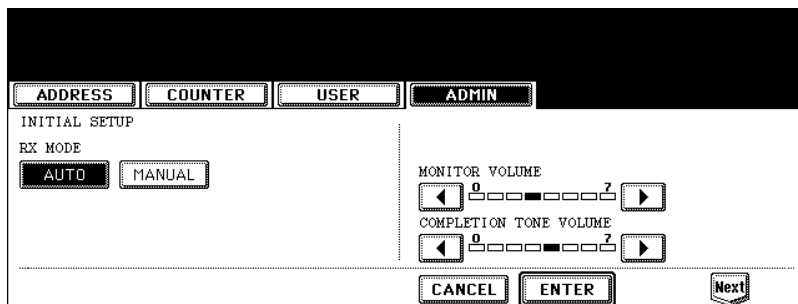

7 Press the [ENTER] button.

- The registered items can be confirmed in the Administrator's Function List. To print the list, see the [User Functions Guide].

Note

There is no second screen to display the dial types for the European version.

The screenshot shows a menu interface with four tabs: ADDRESS, COUNTER, USER, and ADMIN. The ADMIN tab is selected. Below the tabs, the text 'INITIAL SETUP' is displayed. Under 'EX MODE', there are two buttons: 'AUTO' (which is highlighted) and 'MANUAL'. To the right, there are two volume control sections: 'MONITOR VOLUME' and 'COMPLETION TONE VOLUME'. Each section has a numeric display showing '0', a progress bar, and a '7' at the end, with left and right arrow buttons for adjustment. At the bottom of the screen, there are three buttons: 'CANCEL', 'ENTER' (which is highlighted), and 'Next'.

The screenshot shows the same menu interface as above, but with the 'DIAL TYPE' section visible. It contains two buttons: 'DP' and 'MF'. The 'ENTER' button at the bottom is highlighted. The 'Next' button is replaced by a 'Prev' button.

4. Setting RX Printing

Setting RX printing

Set print settings for originals received on the Fax that are to be printed. 2 print installations are available: discard printing and RX reduction printing.

- **Discard Printing**

ON (default setting):

When originals are up to 10 mm larger than the printing area; the part of the originals that extends beyond the paper printing area is discarded.

OFF:

The received original is printed on 2 sheets of paper if its length exceeds the paper printing area.

* For the detail of DISCARD setting, contact your service technician.

- **RX reduction printing**

ON (default setting):

If the received original is longer than the recording paper, it will be vertically reduced to 90%* to fit on the installed receiving paper.

* LG size original is vertically reduced to 75% to fit on LT or LT-R paper.

OFF:

The received original is printed on 2 sheets of paper if its length exceeds the paper printing area.

* Drawers can be set for received Fax printing only. See the [Operator's Manual for Basic Function]. Be sure to use LD, LG, LT, LT-R, A3, A4, A4-R or B4.

Tip

For the relationship between the received original and the output paper, see  P.62 "3.Relationship between Original and Paper".

7

1 Press the [USER FUNCTIONS] button on the control panel.

2 Press the [ADMIN] button and then the [PASSWORD] button.

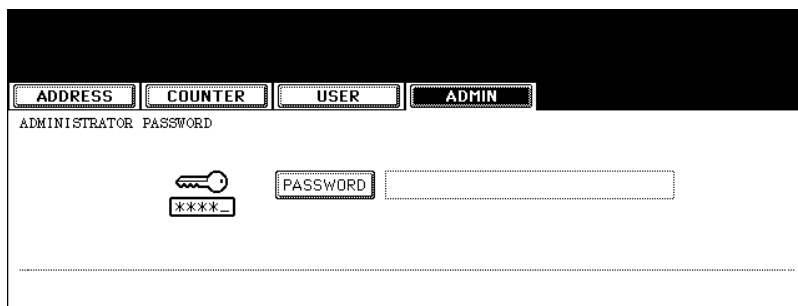

3 Enter the administrator password (6 to 10 digits), and then press the [ENTER] button.

- Ask your administrator for the administrator password.

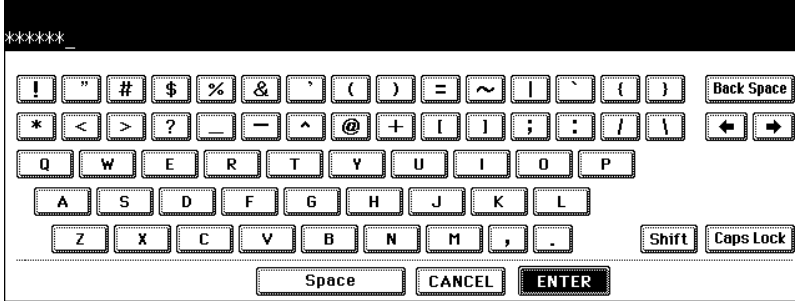

4 Press the [FAX] button.

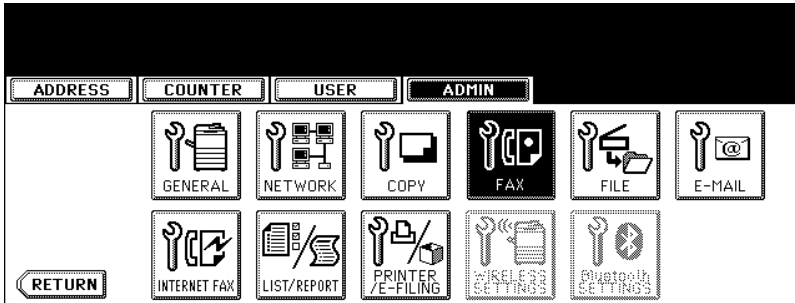

5 Press the [RX PRINT] button.

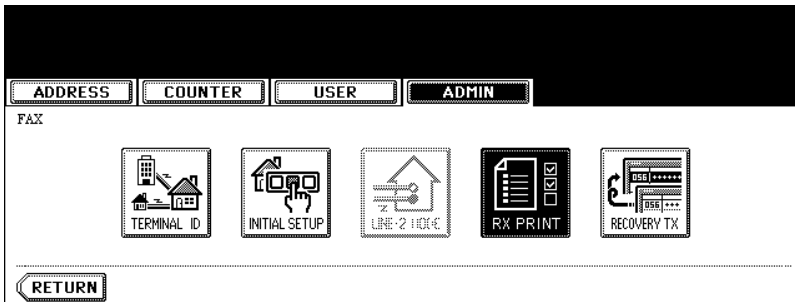

6 Press the [ON] or [OFF] button of the [DISCARD] and/or [REDUCTION], and then the [ENTER] button.

- The registered items can be confirmed in the Administrator's Function List. To print the list, see the [User Functions Guide].

The screenshot shows a menu interface with a black header bar containing four tabs: ADDRESS, COUNTER, USER, and ADMIN. The ADMIN tab is selected. Below the header, the menu is divided into two columns by a vertical dotted line. The left column contains the following options: EX PRINT, DISCARD (with ON and OFF buttons), and REDUCTION (with ON and OFF buttons). The right column contains: DUPLEX PRINT (with ON and OFF buttons) and ROTATE SORT (with ON and OFF buttons). At the bottom of the menu, there are two buttons: CANCEL and ENTER.

Setting duplex printing

This printer setting determines whether or not to print received Faxes on both sides of the paper available for Fax reception.

- Duplex printing is available only if the received original sizes and resolution are the same.
- When the paper has run out during duplex printing, the rest of the document is printed on another size paper.
- When the received original is printed on 2 sheets of paper because it exceeds the printing area, the duplex printing is not available.
- Documents received using the batch transmission function are printed on both sides of the paper as one continuous document. Pay attention to the separation of the individual documents particularly those consisting of an odd number pages.

1 Press the [USER FUNCTIONS] button on the control panel.

2 Press the [ADMIN] button and then the [PASSWORD] button.

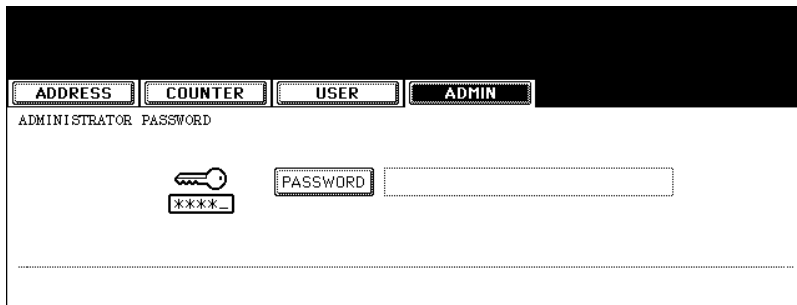

3 Enter the administrator password (6 to 10 digits), and then press the [ENTER] button.

- Ask your administrator for the administrator password.



4 Press the [FAX] button.



5 Press the [RX PRINT] button.

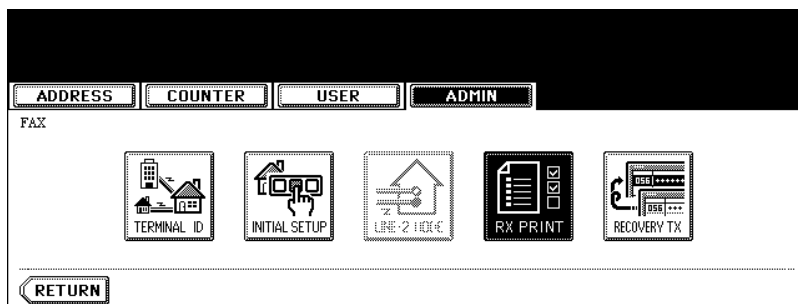

6 Press the [ON] button for the duplex print function, and then press the [ENTER] button.

- The registered items can be confirmed in the Administrator's Function List. To print the list, see the [User Functions Guide].

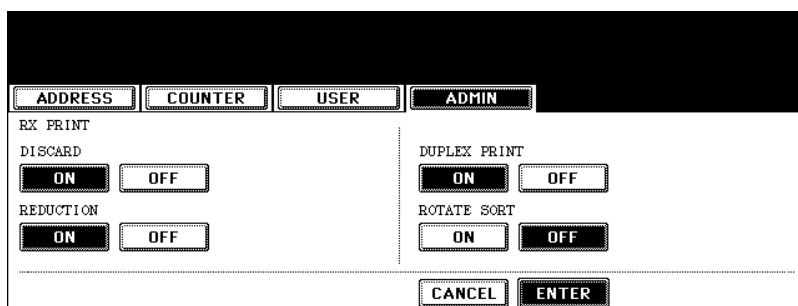

Tips

Duplex printing direction differs depending on the received original size.

1. Received LD, LG, LT, A3, A4, or B4-sized originals are printed so that they can be bound along the long edge of direction.
2. Received ST, A5 or B5-sized originals are printed so that they can be bound along the short edge of direction.

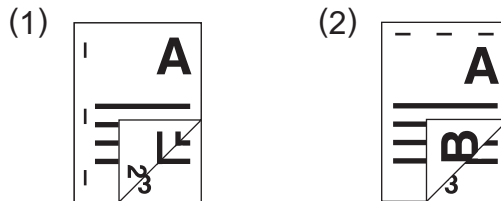

Even when “Duplex Printing” is selected, one-sided printing will be applied to the following two items.

1. Received fax documents which are relay-transmitted
2. Received fax documents which are sent to forward mailboxes

See the TopAccess Guide for details.

Setting the rotate sort (Alternation)

This printer setting determines whether or not to output each separate Fax job by rotated sort (90 degrees) alternately.

- * Rotate Sort is available only for LT/A4-sized paper. Set the LT and LT-R, or A4 and A4-R drawers.
- * If paper becomes empty during Rotate Sort, the rest of the document is printed on the remaining paper.

1 Press the [USER FUNCTIONS] button on the control panel.

2 Press the [ADMIN] button and then the [PASSWORD] button.

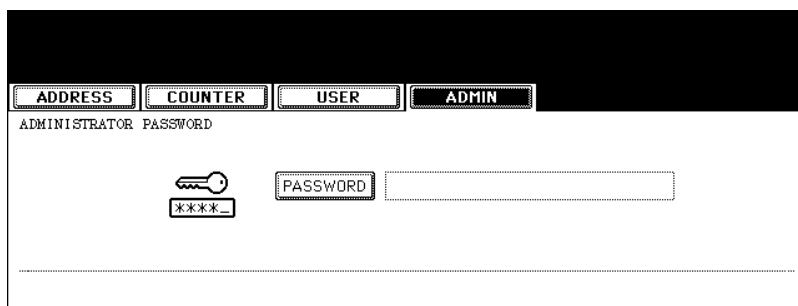

3 Enter the administrator password (6 to 10 digits), and then press the [ENTER] button.

- Ask your administrator for the administrator password.

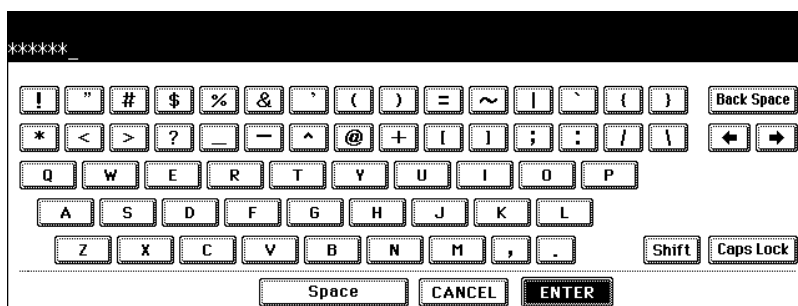

4 Press the [FAX] button.



5 Press the [RX PRINT] button.

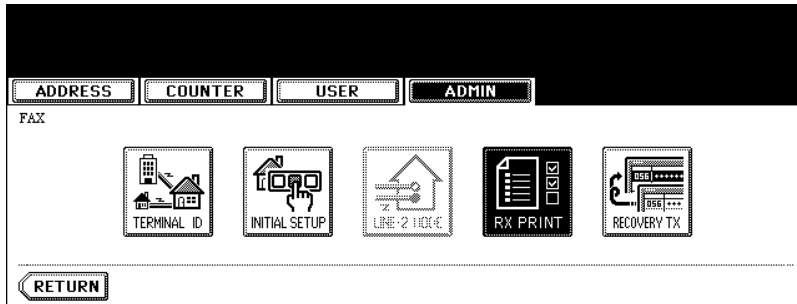

6 Press the [ON] button for the rotate sort function, and then press the [ENTER] button.

- The registered items can be confirmed in the Administrator's Function List. To print the list, see the [User Functions Guide].

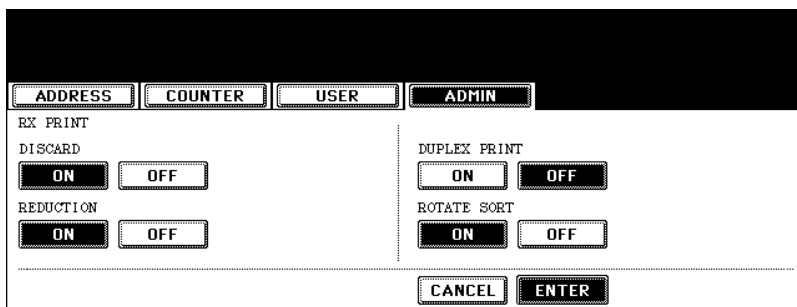

5. Setting Recovery Transmission

Setting the document-holding-time for retaining a document in memory using the Recovery Transmission function.

- 1 Press the [USER FUNCTIONS] button on the control panel.
- 2 Press the [ADMIN] button and then the [PASSWORD] button.

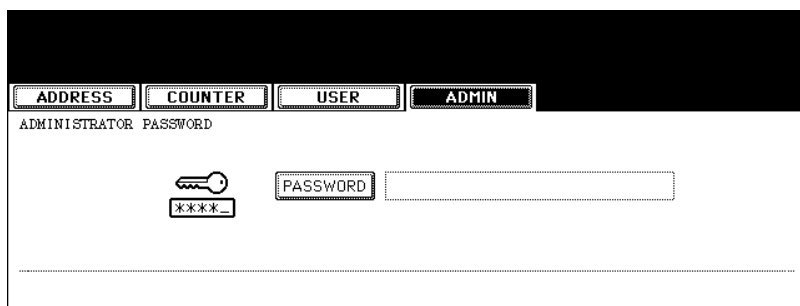

- 3 Enter the administrator password (6 to 10 digits), and then press the [ENTER] button.

- Ask your administrator for the administrator password.

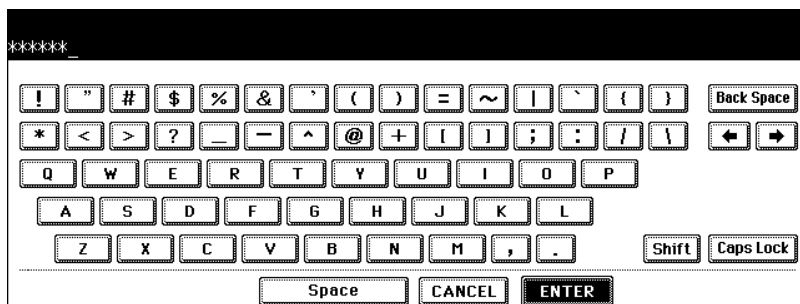

- 4 Press the [FAX] button.



5 Press the [RECOVERY TX] button.

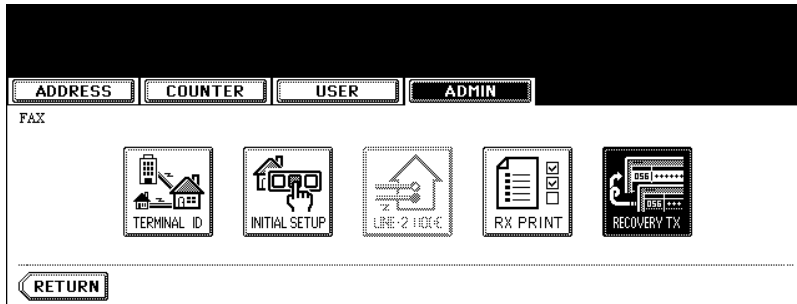

6 Change the document-stored time with the [← 1H] or [24H →] button, and press the [ENTER] button.

- The document-holding time can be changed in 1 hour increments.

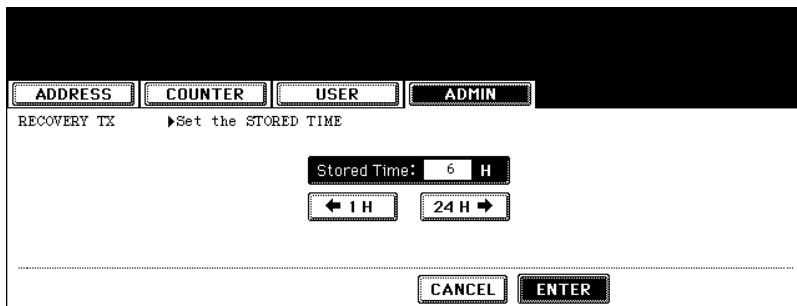



7

8. TROUBLESHOOTING

1. When The Following Messages Appear	170
2. Transmission Trouble.....	171
3. Reception Trouble.....	172

1. When The Following Messages Appear

When the following messages appear on the touch panel, press the [FUNCTION CLEAR] button to clear the error message and perform the appropriate remedy for the error. For details of messages not listed below, see the [Operator's Manual for Basic Functions].

Message	Cause	Remedy
Memory overflow	Memory overflowed when scanning documents to the memory.	Either wait for memory to be cleared, or check the jobs and delete reserved jobs to clear memory.
Communication error	Communication error occurred during direct TX.	Retry communications.
Job reservation full	The number of reserved jobs exceeded 100.	Either wait for job reservations to be completed, or check the jobs and delete reserved jobs.
Job memory full	The total number of destinations for outgoing call jobs exceeded 1,000.	Either wait for outgoing call jobs to be completed, or check the jobs and delete reserved jobs.
Sorry not possible	On-hook or direct TX was attempted during communications.	Wait for communications to end and retry communications.
Not allowed now	Further polling transmission reservation was attempted even though polling transmission was already reserved.	Either wait for polling transmission jobs to be completed, or check the jobs and delete reserved jobs.
Too Many Tel # Digits	128 digits or more were registered for a chain dial communication.	Confirm the number of digits dialed and register the numbers again.

2. Transmission Trouble

Check the following points if you are having trouble sending documents.

If you cannot rectify the problem with the points below, or the problem is not listed below, call service for assistance.

Trouble	Check Point
"TRANSMIT" is not displayed even if the [START] button is pressed.	<ul style="list-style-type: none"> • Did you replace the handset before you pressed the [START] button? When you are making a call on the handset to send a Fax, do not replace the handset until you press the [START] button. • Is the modular cord disconnected? • Is the power plug unplugged from the power outlet? • Can you receive telephone calls? • Is there any problem at the remote Fax? Check this with the party trying to receive the original.
Originals are fed diagonally.	<ul style="list-style-type: none"> • Are the document feeder slides adjusted to the width of the original that you are sending? • Does the original that you are sending match the conditions of the original that is available for sending?
2 originals are fed together.	<ul style="list-style-type: none"> • Have you placed more than the maximum number of originals that can be placed at one time? • Does the original that you are sending match the conditions of the original that is available for sending? • Have you pushed the originals into the feeder too hard?
The original is not being printed on the paper of the remote Fax even though it has been sent.	<ul style="list-style-type: none"> • Was the original placed correctly facing up?
Black lines are shown in the image that was sent.	<ul style="list-style-type: none"> • Is the scanning area of the Reversing Automatic Document Feeder clean? Clean it with a soft cloth.
Originals are not sent even if operations are carried out normally.	<ul style="list-style-type: none"> • Is the remote Fax compatible with your system? This system supports G3 communications but not G2 or G4 communications.
Originals cannot be sent overseas.	<ul style="list-style-type: none"> • Specify Quality TX and resend. (📖 P.29 "4.Setting the Transmission Conditions")

3. Reception Trouble

Check the following points if you are having trouble receiving documents. If you cannot rectify the problem with the points below, or the problem not listed below, call service for assistance.

Trouble	Check Point
Originals cannot be received even if "RECEIVE" is displayed and the [START] button is pressed.	<ul style="list-style-type: none">• Did you replace the handset before you pressed the [START] button? When you answer a call on the handset to receive a Fax, do not replace the handset until you press the [START] button.• Is the modular cord disconnected?• Is there a problem at the remote Fax? Check this with the party trying to send the original.
Paper is not output.	<ul style="list-style-type: none">• Is the equipment out of paper?
The received original is printed dark and is illegible or black stripes are printed on the original.	<ul style="list-style-type: none">• Make a local copy and confirm proper printing.• Is the original being sent a dirty copy? Check this with the party trying to send the original.• Is the trouble due to a problem or operation error at the remote Fax? Check this with the party trying to send the original.
Paper is output but not printed.	<ul style="list-style-type: none">• Is there enough toner?• Is the original placed correctly on the remote Fax? Check this with the party trying to send the original.
Paper often jams.	<ul style="list-style-type: none">• Is the paper drawer size setting correct?• Is the paper drawer properly inserted?• Is the specified paper type being use?

9. SPECIFICATIONS

1. Main Specifications 174

1. Main Specifications

Model Name	GD-1170 (For DP-5200/6000/7200/8500)
Size of Original (North America)	LD, LG, LT, LT-R, ST, ST-R, COMP
Size of Original (European)	A3, A4, A4-R, A5, A5-R, B4, B5, B5-R, FOLIO
Recording Paper Size (North America)	11" x 17" (LD), 8.5" x 14" (LG), 8.5" x 11" (LT), 5.5" x 8.5" (ST), 10. 1/8" x 14" (COMP)
Recording Paper Size (European)	297 mm x 420 mm (A3), 210 mm x 297 mm (A4), 148 mm x 210 mm (A5), 257 mm x 364 mm (B4), 182 mm x 257 mm (B5), 210 mm x 330 mm (FOLIO)
Compatibility Communication Modes	Exclusive Mode, ECM, G3
Communication Resolution	Horizontal: 8 dots/mm, 16 dots/mm, 300 dots/inch
	Vertical: 3.85 lines/mm, 7.7 lines/mm, 15.4 lines/mm, 300 dots/inch
Transmission Rate	33,600/31,200/28,800/26,400/24,000/21,600/19,200/16,800/14,400/12,000/9,600/7,200/4,800/2,400 bps
Encoding Systems	JBIG/MMR/MR/MH
Printing Method	Laser electronic printing
Memory Capacity	Transmission/Mailbox: 500 MB (HDD) Reception: 120 MB (HDD) ^{*1}
Unit Type	Desktop type, transmitting/receiving dual type
Applicable Network	Public Switched Telephone Network (PSTN)

*1 For hard drives, MB means 1 million bytes. (Total hard drive accessible capacity may vary depending on operating environment.)

When the total time that the power is turned off for 12 hours a day becomes about 5 years, the battery will be dead. If the battery is run down, ask your service technician. (Repair and replacement will be charged.)

- * Specifications and appearance are subject to change without notice in the interest of product improvement.
- * If trouble occurs, call service for assistance. (See the [Operator's Manual for Basic Function])

INDEX

A	
About Originals	25
Acceptable size of paper	62
ACCESS button	17
Address book entry	22, 38
Address book information	120
Address registration from send/receive log	70
AUTO	125
AUTO reception	59
Automatic Reception	58
Automatically Printing Lists & Reports	124
B	
Batch Transmission	23
Bulletin board mailbox	84
Bypass cover	14
Bypass tray	14
C	
Canceling data in mailbox	99
Canceling direct transmission (during scanning)	76
Canceling recovery transmission	110
Canceling reserved memory transmissions	74
Canceling transmissions	
Canceling transmissions	72
During memory transmission	75
During scanning	72
Chain Dial Communication	23, 104
Checking communication status (log)	68
Checking reserved transmissions	66
Checking Transmission Result	66
CLEAR button	17
Clearing and canceling function selected	19
Confidential mailbox	84
Configuration of options	15
Confirming the destinations	48
Connecting cables	20
Control panel	14, 16
COPY button	16
D	
Delayed Communications	23
Delayed Transmission Reservation	106
Deleting mailbox	91
Description of Each Component	14
Dial type (Line 1)	155
Digital keys	17
Direct entry with digital keys	22, 37
Direct transmission	22, 49
Direct transmission by optional setting	49
Direct transmission report	124
Discard Printing	158
Disclaimer Notice	11
Drawers	14
E	
ECM (Error Correction Mode)	29, 148
e-FILING button	16
ENERGY SAVER button	17
Error code table	122
ERROR lamp	17
Exit cover	14
Exposure	29, 148
EXTENSION button	16
F	
FAX button	16
Features of the GD-1170	9
Front cover	14
FUNCTION CLEAR button	17
Function list	120
Function setting area	18
G	
Group entry	22, 39
Group numbers information	120
H	
HELP button	16
I	
Index buttons	18
Individual polling reception	83
Inputting data in confidential / bulletin board mailbox	97
INTERRUPT button	16
ITU Mailbox list	120
J	
JOB STATUS button	17
L	
Lists/Reports Samples	133
Log	68
M	
Mailbox Communication	84
Mailbox reception report	
Automatically output	142
Mailbox reception report	124
Mailbox Transmission	22
Mailbox/relay box report (Manually output)	137
Main components	14
Main Specifications	174
Manual reception	59, 61
Manually Printing Lists & Reports	120
Memory Reception	58
MEMORY RX / FAX communication lamps	16
Memory transmission	22, 51
Memory transmission report	
Automatically output	138
Memory transmission report	124
Message area	18

-
- MODE (Original mode) 148
 Modifying relay mailbox 93
 Monitor tone volume 155
 MONITOR/PAUSE button 17
 Multi transmission report
 Automatically output 140
 Multi transmission report 124
 Multi-address relay mailbox 84
 Multi-address transmission 22, 47
 Multi-polling reception 83
- N**
 NOTICE TO USERS 3
- O**
 Off-hook transmission 22, 54
 Offramp gateway overview 113
 On-hook transmission 22, 53
 Onramp gateway overview 111
 Operator's Manual pocket 14
 Original cover 14
 Original glass 14
 Original Mode 29
 Original scale 14
 Original scanning range 25
 Original size 25, 29
- P**
 Paper feed cover 14
 Paper priority when there is
 no same size paper 63
 Paper size indicator 14
 PDF (MULTI) 117
 PDF (SINGLE) 117
 Polling Communication 81
 Polling data out of mailbox 102
 Polling reception 58, 83
 Polling report
 Automatically output 141
 Polling report 124
 Polling transmission 22, 81
 Power failure list
 Automatically output 146
 Power failure list 124
 Power switch 14
 Precautions for using the Reversing
 Automatic Document Feeder 27
 Preparation for Transmission 24
 PRINT DATA lamp 17
 Printing Fax out of mailbox 96
 Printing ITU mailbox list 123
 Printing reservation list 122
 Printing transmission/reception journals 120
 Priority Transmission 22, 80
- Q**
 Quality TX 30
- R**
 Reception completion tone volume 155
 Reception journal
 Manually and automatically output 135
 Reception journal 120, 124, 125
 Reception mode 58, 155
 Reception Settings 59
 Recovery Transmission 22, 109
 Redialing 23
 Registering the Terminal ID 150
 Relationship between Original and Paper 62
 Relay station report 124
 Relay transmission end terminal report
 Automatically output 145
 Relay transmission end terminal report 124
 Relay transmission originator terminal report
 (Automatically output) 143
 Relay transmission relay station report
 Automatically output 144
 Relay transmission relay station report 124
 Releasing the department code error 67
 Reservation list
 Manually output 136
 Reservation list 120
 Resolution 29, 148
 Reversing Automatic Document Feeder 14
 RTI recording 148
 RX reduction printing 158
- S**
 Save as File 115
 SCAN button 16
 Scanning area 14
 Searching address using LDAP server 45
 Searching by address (Search address) 42
 Searching by ID number 40
 Sending different width originals 33
 Sending Originals 49
 Setting duplex printing 161
 Setting originals 26
 Setting Recovery Transmission 166
 Setting relay mailbox 112
 Setting RX printing 158
 Setting RX printing during default setup 62
 Setting the (transmission/reception)
 journal output and its number 125
 Setting the communication report output 127
 Setting the Initial Transmission Mode 148
 Setting the lists and reports output 125
 Setting the reception list output 130
 Setting the Reception Mode 155
 Setting the rotate sort (Alternation) 164
 Setting the scanning conditions for each page ..35
 Setting the transmission conditions 31

Setting up mailbox for confidential and bulletin board communication	85
Setting up relay mailbox	87
SID/PWD	30
Specifying the Remote Fax	37
START button	17
STOP button	17
SUB/SEP	30
Subject, Body	30
Switching to the Fax mode	24
T	
TEMPLATE button	17
TIFF	
MULTI	117
SINGLE	117
To receive an E-mail using SMTP	114
Toner cartridge	14
Toner cartridge holder	14
Toner cover	14
Touch panel	14, 17, 18
Touch panel contrast adjustment dial	14, 16
Touch-button area	18
Transfer/Transport unit	14
Transmission journal	
Manually and automatically output	133
Transmission journal	120, 124, 125
Transmission Mode	22
Transmission report (Automatically output)	139
Transmission type	29, 148
Transmitting 2-Sided Originals	78
Transmitting data in offramp gateway	114
Transmitting Fax to mailbox	100
TTI recording (Setting is not available in all product markets)	
	148
U	
USER FUNCTIONS button	17
V	
Variety of optional functions	29
W	
When power failure occurs	10
When setting originals on the glass	26
When the use of the equipment is managed under certain functions such as department management	24
When using the Reversing Automatic Document Feeder	28

MULTIFUNCTIONAL DIGITAL SYSTEMS
Operator's Manual for Facsimile Function

GD-1170

TOSHIBA TEC CORPORATION

2-17-2, HIGASHIGOTANDA, SHINAGAWA-KU, TOKYO, 141-8664, JAPAN



Percentage of Waste Paper pulp 100%

