

051790

OPERATING INSTRUCTIONS

Label Dispenser

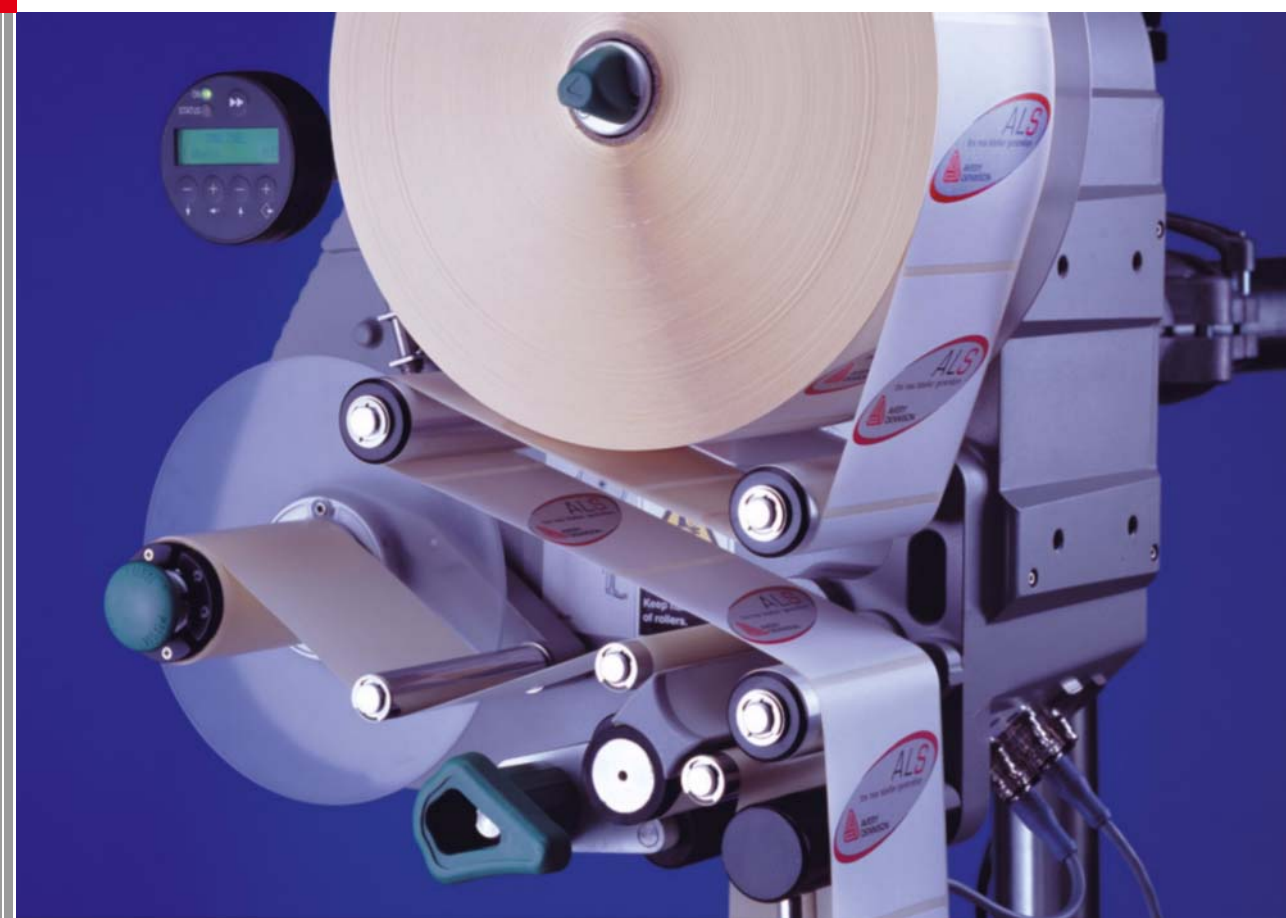

ALS

204/206

256

Edition 04/2007

1	Please note	
1.1	General notes	
1.1.1	Validity and binding effect of this manual	1
	Contents	1
	Technical status	1
	Copyright	1
	Manufacturer	1
1.1.2	Illustrations and descriptions	2
	Signs and symbols	2
	Dangers and risk notes	2
	Figures	2
	Button symbols	2
	Parameters	2
	Supplementary information	2
1.2	Safety instructions	
1.2.1	Information and qualifications	3
	Follow the instructions	3
	Keep the product information at hand	3
	Ensure the required qualifications are met	3
1.2.2	Operational safety of the unit	4
	Proper usage	4
	Protection against injuries by electrical current	4
	Protection against injuries by mechanical action	5
	Protection against injuries by chemicals	5
1.2.3	Before beginning production	6
	Due diligence of the operating company and the service technician	6
	Due diligence of the user	6
1.2.4	Safety notes on the unit	7
2	Product description	
2.1	Overview	
2.1.1	Components	8
2.1.2	Control panel	10
	Operating LED	10
	Error LED	10
	LCD display	10
	Buttons	10
2.1.3	Connection arrangement	11
	Connections on the back of the device	11
	Sensor connections	12
2.1.4	Mode of operation	13
2.1.5	Technical specifications	14
	Characteristics	14
	Labels	14
	Label sensor	14
	Power supply	14
	Electronics	15
	Interfaces	15
	Internal Interfaces	15
	Status messages, test functions, product profiles	15
	Dimensions	16
	Environmental conditions	16
	Integration	16
	Certificates	16
2.1.6	Design models	17
	Right-handed version	17
	Left-handed version	17
2.2	Options	
	External control panel	18
	Fixed dispensing edge	18
	Swivelling dispensing edge	18
	Spring-loaded dispensing edge	18
	Pneumatic dispensing edge	19
	V-shape dispensing edge	19
	Adjustable dispensing edge holder	19
	Outer Diameter control sensor	20
	Printer	20
	Applicator	20
	Applicator interface	20
	Dust/Splash guard	20
2.3	Operating modes	
2.3.1	Dispensing mode	21
	Stopping/Continuing the dispensing mode	21
	Changing the counter reading	21
	Starting the unit in configuration mode	21
	Counting labels backwards	21
	Online settings	22
2.3.2	Configuration mode	23
	Function of the double-arrow button	23
	Menus	23
	Functions	24
2.4	Function descriptions	
2.4.1	Function overview	25
2.4.2	Notes on function descriptions	27
2.4.3	LABEL SETUP menu	27
2.4.4	MACHINE SETUP menu	27
2.4.5	SERVICE DATA menu	28
	> MODULE FW VERS. submenu	28
	> OPERATIONAL DATA submenu	28
	>POWER SUPPLY DATA submenu	28

> CPU BOARD DATA submenu	28	Material end	44
> DISPLAY DATA submenu	28	Material tear	44
> CF CARD SLOT submenu	28		
> PERIPHERAL DATA submenu	28		
>MEMORY DATA submenu	28		
3 Before operation		4.3 Using product profiles	
3.1 Electrical connections		4.3.1 What are product profiles?	45
3.1.1 Power supply connection	29	4.3.2 Loading a product profile	45
Checking the power supply setting	30	4.3.3 Storing a product profile	45
Connecting the power cable	30	Selecting the memory location	45
3.1.2 Connecting sensors	31	Entering profile names	45
3.2 Inserting label material		4.3.4 Deleting a product profile	46
3.2.1 Prerequisites	32	5 After operation	
3.2.2 Inserting a label roll	33	5.1 Maintenance and cleaning	
Removing spent backing paper	33	5.1.1 Replacing fuses	47
Removing glue residue	33	5.1.2 Cleaning agents	48
Inserting a new label roll	33	5.1.3 Regular maintenance	49
3.2.3 Threading the label roll	34	Removing paper debris	49
Threading guide	34	Renewal of the dust filter liner (ALS 256)	49
Threading the label roll at the dispensing edge	35	6 Operational failures	
Threading the label roll onto the drive roller	36	6.1 Error messages	
Fastening the label roll to the rewinder	36	6.1.1 Reporting errors	50
3.3 Mechanical settings		6.1.2 List of error messages	50
3.3.1 Adjusting the unwinder's core diameter	37	7 Appendix	
3.3.2 Positioning the pressure roller	37	7.1 EU Declaration of Conformity	
3.3.3 Positioning the label sensor	38		
4 Operation			
4.1 Start-up and shutdown			
4.1.1 Turning on the unit	39		
4.1.2 Starting label dispensing	39		
Dispensing with a product sensor	39		
Dispensing without a product sensor	39		
4.1.3 Stopping the dispensing process	40		
4.2 Configuration and monitoring			
4.2.1 Function menu settings	41		
Label pitch	41		
Label stop position	41		
Dispensing speed	42		
Label position on the product	43		
4.2.2 Monitoring functions	44		
Missing labels	44		

1.1 GENERAL NOTES

1.1.1 Validity and binding effect of this manual

Contents

The present manual refers exclusively to the ALS 204, ALS 206 and ALS 256 label dispensers. It is written for the purpose of ensuring professional usage and calibration of the unit.

Prerequisites for the use and adjustment are the professional installation and configuration of the unit.

For any technical questions you may have that are not described in this manual, see:

- The service manual of the label dispenser
or
- Request a technician from one of our sales partners.
- Our sales representatives are available to assist you, particularly with configuring the unit as well as in the case of malfunctions.

Technical status

Technical status: 04/2007

Software version: 1.02

Avery Dennison reserves the right:

- To make modifications to construction parts, components and software, as well as to employ comparable components in place of the parts specified, in keeping with technical advances.
- To modify information in this document.

No commitment will be made to expand these modifications to include any units delivered earlier.

Copyright

Avery Dennison holds all rights to this manual and its appendices. Reproduction, reprinting or any other types of duplication, even of portions of this manual, may only be carried out with express written consent. Third persons, in particular competitors, should not be given access to the information in this manual.

Printed in Germany

Manufacturer

Avery Dennison Deutschland GmbH
Ohmstrasse 3
85386 Eching, Germany
Phone: +49-8165-925-0
Fax: +49-8165-3143
<http://www.machines.averydennison.com>

1.1 GENERAL NOTES

1.1.2 Illustrations and descriptions

Signs and symbols

Various information types are indicated in different ways within the document in order to simplify readability and comprehension.

Sentences starting with an arrow are instructions and guidelines.

→ Perform the instructions one after another in the specified order.

The following information begins with a dash:

- Lists
- Mode descriptions
- Descriptions of prior steps
- Prerequisites for following actions

Dangers and risk notes

Important directions that you must absolutely observe are particularly emphasized:



WARNING!

A warning refers to risks that can lead to serious injury or death! The warning contains safety measures to protect the relevant persons.

→ Always follow the instructions.



CAUTION!



A caution indicates risks that can lead to property damage or injuries to persons (minor injuries). The caution note contains instructions for preventing damages.

→ Always follow the instructions.

Figures

Texts are accompanied by figures where necessary. Figures are indicated using figure numbers in [square brackets]. A capital letter after a figure number, for example [12A], refers to a specific section of the figure. Generally, the label dispenser shown is an ALS 104 right-handed version. The left-handed version is only shown where it is necessary to differentiate between the two.

Button symbols

- The buttons of the control panel are depicted as symbols.
- The symbols are depicted with a '+' (PLUS SIGN) between them if more than one button is to be pressed.  + 

Parameters

Parameters are displayed in grey in the text with the following structure, MENU NAME > Function name.

Supplementary information



The expert symbol indicates actions that are only to be performed by qualified and specially trained personnel.



The information symbol indicates notes and recommendations, as well as additional information.



Equipment:

- Equipment, for example lubricants or cleaning agents

1.2 SAFETY INSTRUCTIONS

1.2.1 Information and qualifications

Follow the instructions



WARNING!

Safe and efficient operation of the label dispenser can only be guaranteed if you observe all necessary information.



Product liability and warranty claims can only be asserted if the unit was operated in accordance with the directions in the manual.

- Before operating the unit, read the operating instructions and all other notes carefully.
- Observe the additional safety and warning notes on the label dispenser.
- Only permit competent people to operate and configure the label dispenser.

Keep the product information at hand



With respect to this manual:

- It should be kept at the location where the unit is installed and be available to the operator.
- It should always be legible.
- If the unit is sold, the manual should be made available to the new owner.
- The safety and warning notes affixed to the unit itself must be kept clean and legible. Missing or damaged signs must be replaced.

Ensure the required qualifications are met

- Ensure that only trained and authorized personnel operate, configure and service the unit.
- Only allow qualified and well-trained expert personnel or service technicians to perform configurations.
- The responsibilities with regard to operation, configuration and maintenance should be clearly defined and consistently maintained.
- In addition, personnel should also be instructed on a regular basis in matters of occupational safety and environmental protection.

Qualification for operation

The instruction of personnel using the unit must ensure that:

- The operating personnel can use the unit on their own and safely.
- The operating personnel can remedy small operational disruptions on their own.
- At least two people must be instructed in the unit's usage.
- Enough label material must be provided for testing and instructional purposes.

Qualifications for configuring



The configuration of the controls requires qualified expertise:

- Personnel configuring the unit must be acquainted with the functionality of the label dispenser.
- Personnel configuring the unit must be acquainted with the modes of operation within the facility in which the label dispenser is integrated.
- The personnel configuring the unit must be able to use the additional menus properly and appropriately for specific project requirements.

1.2 SAFETY INSTRUCTIONS

1.2.2 Operational safety of the unit

Proper usage

The ALS 20x Label Dispenser is a fully automatic unit for attaching self-adhesive labels to products or packaging. The company operating the unit must install it with suitable equipment to protect operating personnel from danger; for example, the danger of the hands or fingers being crushed by reaching in between the product and the dispensing edge.



WARNING!

Improper usage of the unit can cause accidents, property damage and production downtime!

- Only use the unit in accordance with the instructions specified in this manual.
- Do not operate the unit without the required safeguards.
- Only configure the unit in accordance with this manual and with the required care.
- Only use original accessories.
- Do not make any modifications or alterations to the unit.
- Repairs to the device may only be performed by authorised specialists who are aware of the risks involved.

Protection against injuries by electrical current



WARNING!

The machine operates using mains voltage! Touching live electrical parts may expose you to hazardous electrical currents and may lead to burns.

- Only operate the unit once the housing has been reassembled properly.
- Only connect the unit to a properly fitted power socket that is grounded.
- Before cleaning, switch off the unit and remove the power cable from the socket.
- Only link the unit to devices that fulfil the SELV (safety extra-low voltage) circuit requirements specified in EN 60950.



WARNING

The unit is not protected against splashing water in its standard model.

- Keep the unit dry.
- If liquids have penetrated the unit, switch it off and disconnect or unplug the power cable immediately. Inform a service technician.



WARNING

The device is *only* completely disconnected from the mains if the power cable *is unplugged*.

- Make sure the power supply socket is accessible.
- In case of emergency, switch off the device and disconnect the power cable.



CAUTION

A too high or low supply voltage can damage the unit.

- Only operate the device using the system voltage indicated on the nameplate.
- Ensure that the mains voltage set on the unit is the same voltage as that provided by the electricity supplier.

1.2 SAFETY INSTRUCTIONS

Protection against injuries by mechanical action



WARNING!

Risk of injury due to moving and rapidly rotating parts!

- Long hair, loose jewellery, long sleeves, and so on are not permissible when using the unit.
- Sufficient protective clothing must be worn.
- Keep moving parts free from obstructions even when the unit is not switched on, if there is a chance the machine might be turned on.
- Switch off the machine before making any mechanical settings.
- Do not wear ties, loose clothing, jewellery, wrist watches or similar items on your person when near the operating unit.



WARNING!

There is a risk that you may get your fingers or hands crushed on the dispensing edge by products on the conveyor belt!

- Never reach between the product and the dispensing edge while the unit is in operation or ready for operation.
- Never reach behind the safety guard or remove it while the unit is in operation.

Protection against injuries by chemicals



CAUTION!

Operating materials such as cleaning agents or the solvents in glues can be damaging to health.

- Always follow the instructions, use and safety regulations specified by the manufacturer!

1.2 SAFETY INSTRUCTIONS

1.2.3 Before beginning production

Due diligence of the operating company and the service technician

- Ensure that the following prerequisites are fulfilled in accordance with the service instructions:
 - The machine is installed properly and configured in accordance with the guidelines.
 - All required safety mechanisms have been installed.
 - The unit has performed at least one successful test run.
 - The unit is connected to the power supply.
- The users have the required personal protective equipment, for example, a hairnet. Ensure that the protective equipment is utilised correctly.

Due diligence of the user

- Check that the safety installations are working properly.
- Inspect the machinery for any visible damage. Report any ascertained defects immediately.
- Use the required personal protective equipment correctly, for example, wear a hairnet.
- Remove any unnecessary materials and objects from the operating area of the unit.
- Ensure that only authorised persons are within the operating range of the machine.
- Ensure that starting up the machine will not injure anyone.

1.2 SAFETY INSTRUCTIONS

1.2.4 Safety notes on the unit

- CAUTION!**
Warning notes on the unit represent important information for the personnel using it.
- Do not remove warning notes.
 - Replace any missing or illegible warnings.

The 'Pinch Point' warning [1] note warns you of the danger posed by the machine's rotating parts; they can trap items and draw them in.

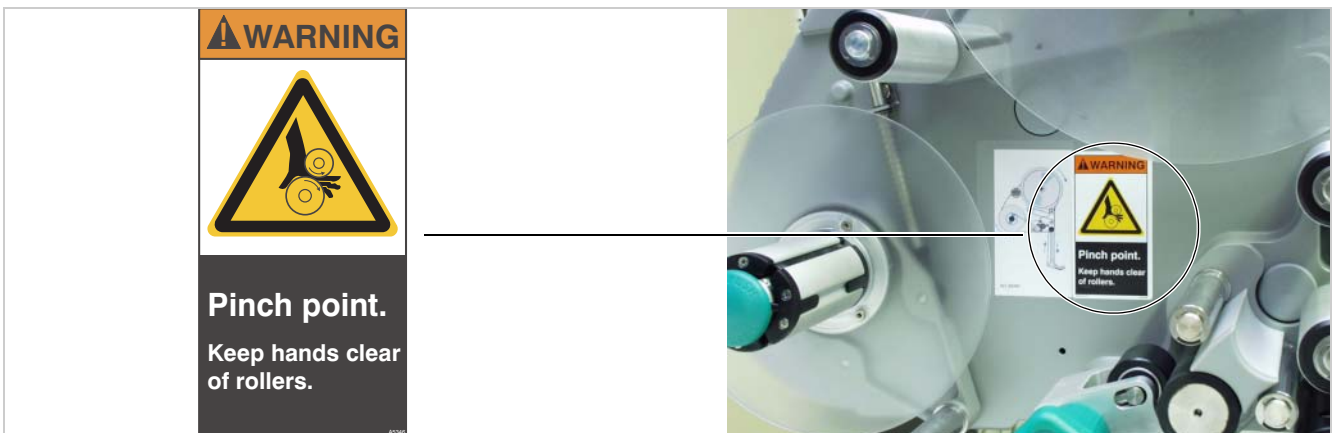

[1] Left: 'Pinch Point' warning. Right: Position of the warning note on the ALS 20x. Item number of the label: A5346.

The blue label 'Read manual' [2] demands that users read the unit instructions.

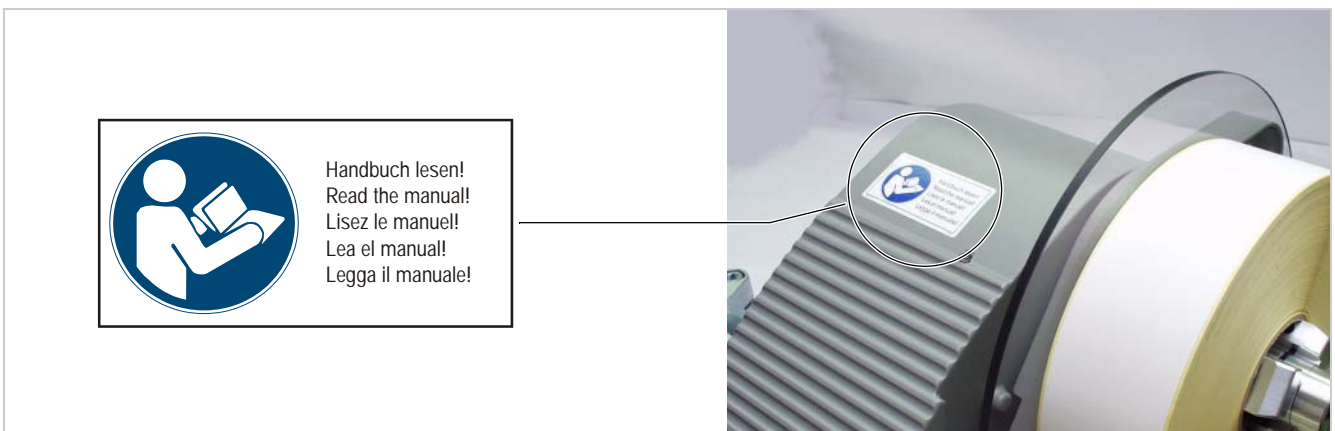

[2] Left: 'Read manual' notice. Right: Position of the notice on the ALS 20x. Item number of the label: A5331.

2.1 OVERVIEW

2.1.1 Components

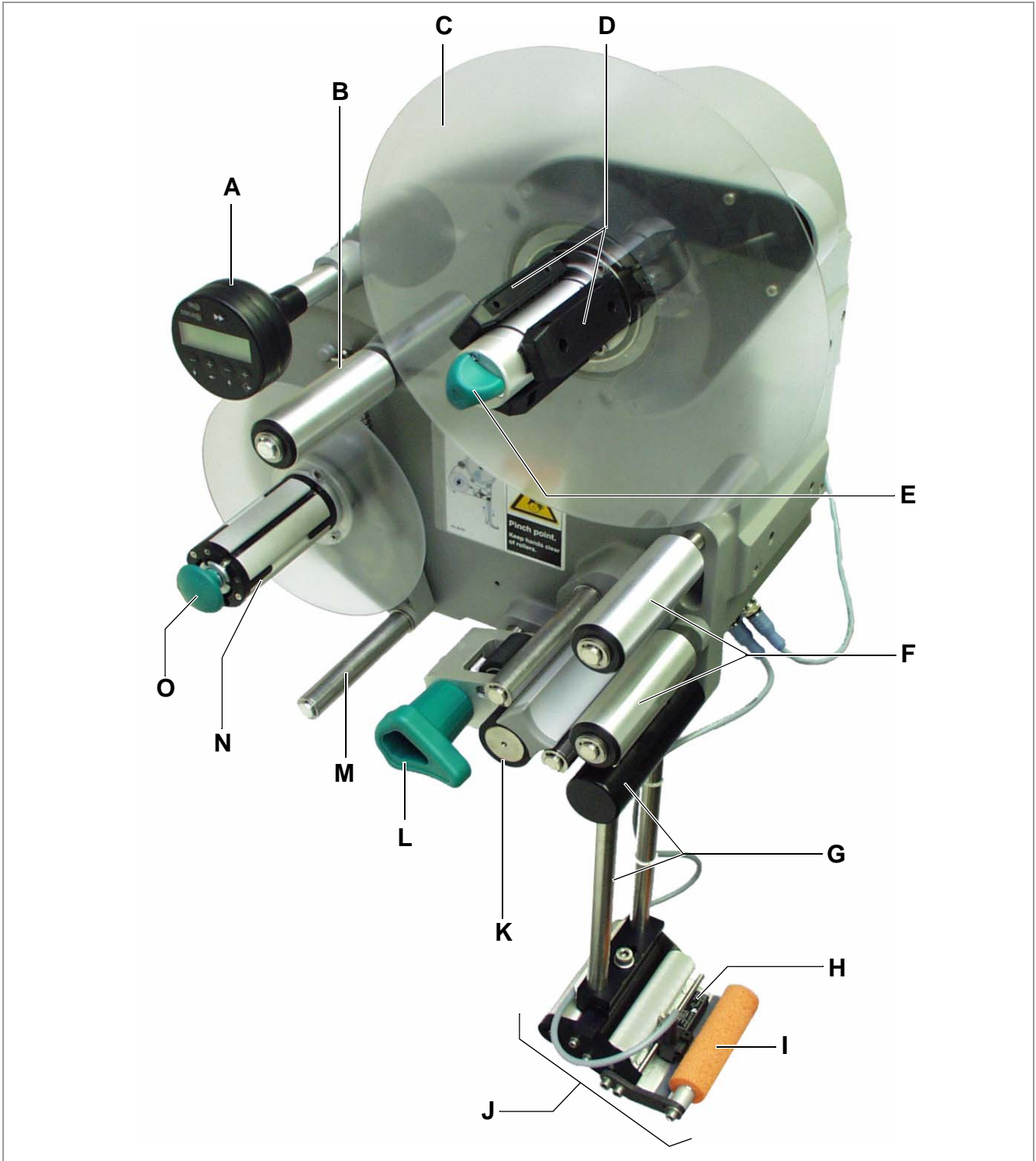

[3] ALS 204 Label Dispenser (right-handed version)

2.1 OVERVIEW

- A Control panel
 - For sending commands to the device and for displaying operating states and error messages.
 - An optional external control panel can also be connected to the device.
- B Dancer arm
 - Keeps the label material stretched tight evenly.
 - Arrests the rotation of the material roll if tension diminishes.
- C Dispenser
 - Dispenser mandrel grasps the label roll.
- D Core diameter adapter
 - For adjusting the diameter of the dispenser mandrel to match the core diameter of the label roll.
- E Adjusting knob
 - Turning this in a clockwise direction secures the label roll on the dispenser.
- F Deflection rollers
- G Dispensing edge bracket
- H Label sensor
 - Stops the label feed after a label has been dispensed.
- I Pressure roller
 - Prints the label once it is stuck to the product.
- J Dispensing edge
 - Standard: (non-adjustable) L-shaped dispensing edge
 - The following options are available: V-shaped dispensing edge, adjustable L-shaped dispensing edge, spring-loaded L-shaped dispensing edge, pneumatic L-shaped dispensing edge
- K Drive roller
 - Drives the label material forwards.
- L Pressure mechanism
 - Presses the pressure roller against the drive roller.
 - Prevents the backing paper from slipping through.
 - Releases automatically once the backing paper has been drawn around the drive roller.
- M Dancer arm
 - Controls the rewind speed.
- N Rewinder
 - Rolls up the used backing paper.
- O Release button
 - Pressing this button reduces the diameter of the rewinder core.
 - Allows the easy removal of the rewound backing paper.

2.1 OVERVIEW

2.1.2 Control panel

Operating LED

Lights up green when the device is switched on.

Error LED

Lights up red when an error occurs.

LCD display

- Displays functions, configured values, operating states and error messages.
- What is displayed at any one time depends on the operating status of the device; these screens are explained in the section “Operating modes” on page 21.

Buttons

The functions of the buttons depend on the operating status of the device; these functions are explained in the section “Operating modes” on page 21.

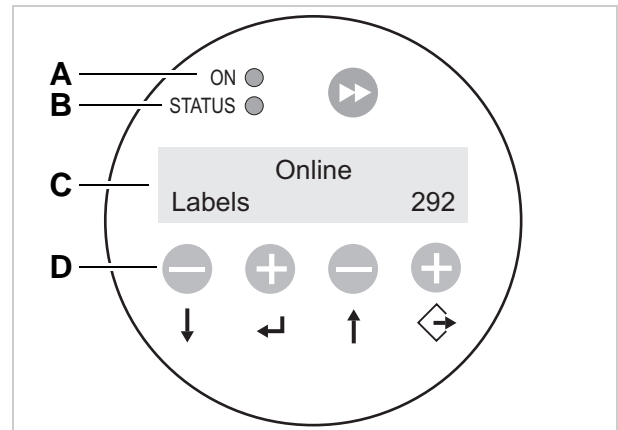

[4] The ALS 20x control panel (in dispensing mode)

- A Operating LED
- B Error LED
- C LCD display
- D Buttons

2.1.3 Connection arrangement

Connections on the back of the device

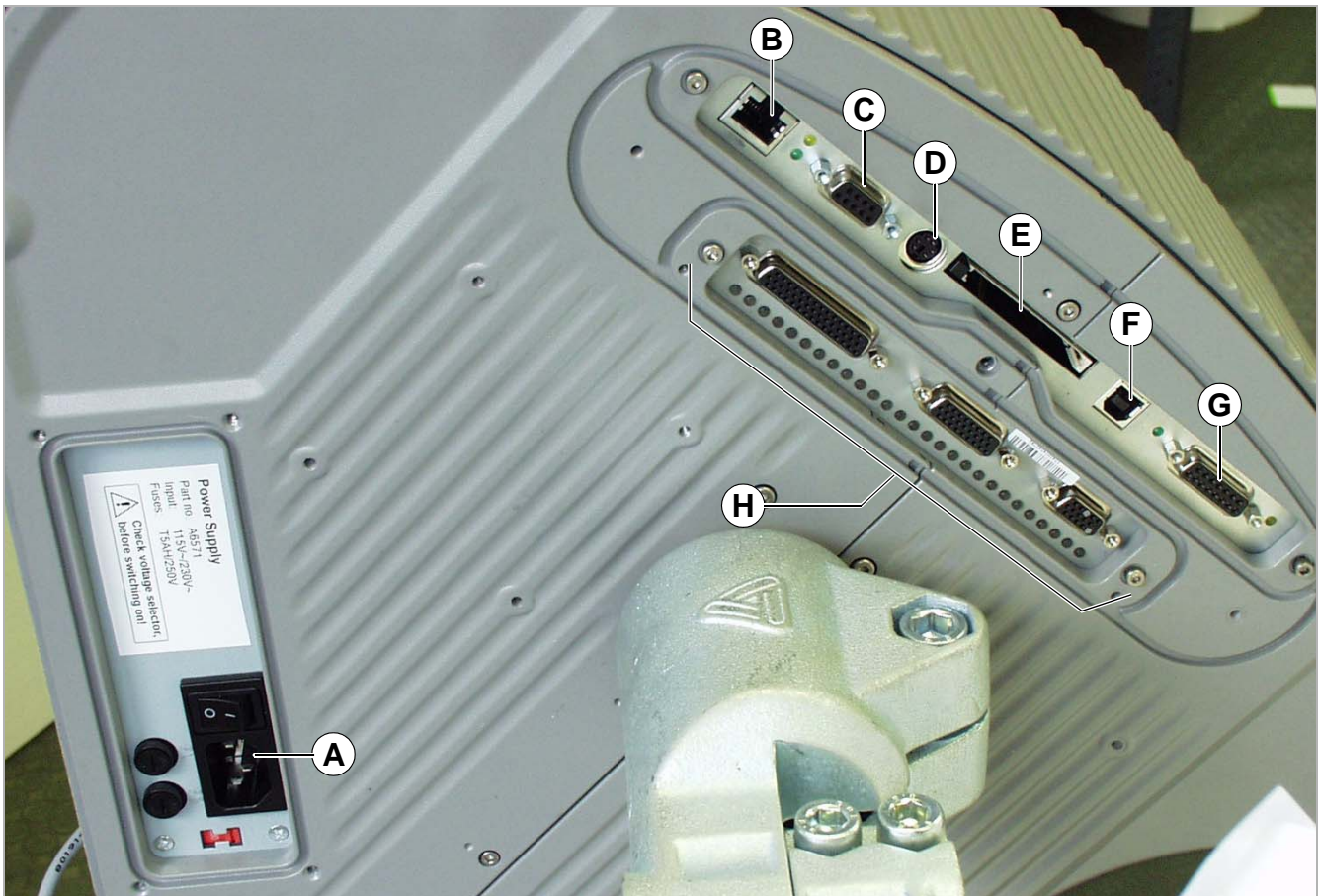

[5] Connections on the back of the device (ALS 20x):

- A Power supply connection
- B Network connection (Ethernet 10/100)
- C Serial interface (RS232)
- D Connection for external control panel (RS485)

- E Plug-in card slot (CompactFlash cards)
- F USB device interface
- G PLC signal interface
- H Optional: Applicator interface

i For information on connecting the unit, see section "Power supply connection" on page 29.

Sensor connections



[6] Sensor connections on the ALS 20x (RH)

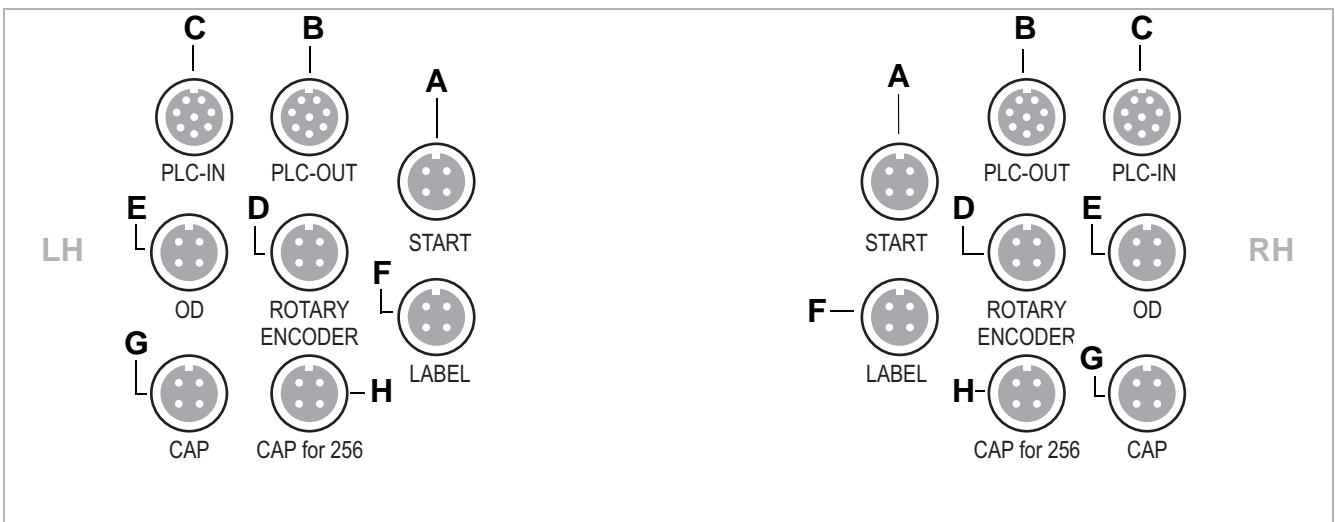

[7] Arrangement of the sensor connections (schematic) on the LH (left figure) and RH (right figure) devices:

- A Product sensor
- B Signal outputs (optional)
- C Signal inputs (optional)
- D Rotary encoder (for automatic speed adaption)
- E Roll diameter sensor
- F Label sensor
- G (ALS 20x) Alternative label sensor
- H (ALS 256) Alternative label sensor



For information on connecting the sensors, see section "Connecting sensors" on page 31.

2.1 OVERVIEW

2.1.4 Mode of operation

In labelling mode, the strip is first pulled from the label roll around the dancer arm [8A], which consistently maintains even tension in the label strip. The feed roller [8D] behind the dispensing edge [8C] draws the strip across the dispensing plate. The label is unfixed from the backing paper on the dispensing plate and is pressed onto the product by the pressure roller [8B].

The feed roller drives the label strip forwards the length of one label and stops until the next product arrives at the dispensing plate. The strip feed is started by the product sensor mounted on the conveyor belt. The stop control provided by the label sensor on the dispensing edge ensures the feed is halted as soon as a gap is detected between two labels.

The spent backing paper runs from the dispensing edge around the drive roller [8D] to the rewinder [8E]. The dancer arm regulates the rewinding speed.

The entire operation of the label dispenser is controlled and monitored electronically. If errors occur, the device controls output an appropriate notification for the operator. If necessary, the labelling operating mode is halted automatically. An electronic signal is output at the same time. The signal can be fed to an external controller and evaluated.

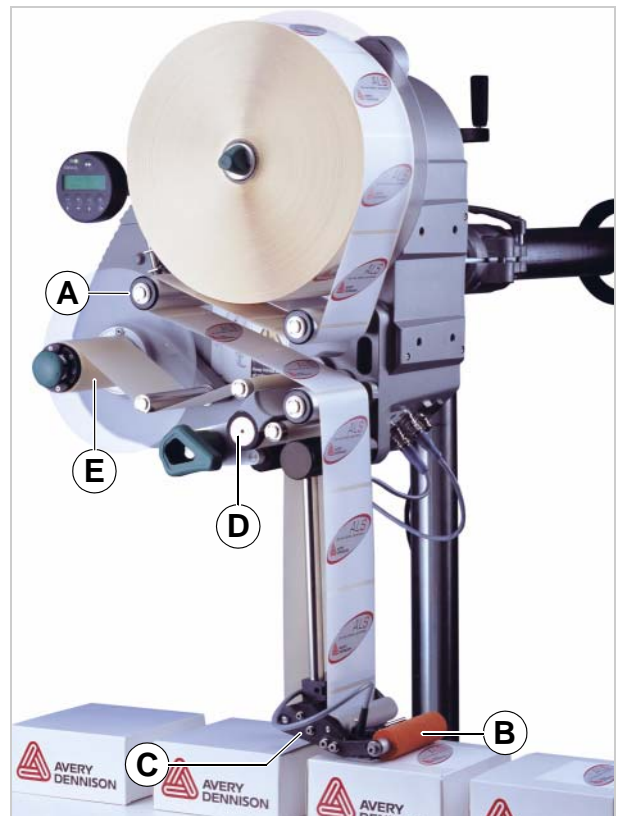

[8] The ALS 20x Label Dispenser is ready for operation in its idle mode.

- A Dancer arm
- B Pressure roller
- C Dispensing edge
- D Drive roller
- E Rewinder

2.1.5 Technical specifications

Characteristics

Dispensing speed ¹⁾ :	
ALS 204	max. 40 m/min
ALS 206	max. 30 m/min
ALS 256	max. 50 m/min
Labelling halt precision ²⁾ at the peeling edge:	
	±1 mm
Speed control:	Fixed setting or automatic speed adaption via the rotary encoder

1) The maximum usable dispensing speed depends on the label geometry. For details see separate performance matrix.

2) At a dispensing speed range of 5 m/min to the max. speed

Labels

Label material:	Converted self-adhesive label material with liner
Internal rewinding	yes
Material width (including backing paper) ³⁾ :	
ALS 204	up to 110 mm
ALS 206	up to 160 mm
ALS 256	up to 160 mm
Label length:	5 to 600 mm
Label roll:	
Winding direction	inner or outer
Dispenser (outer) Ø:	up to 300 mm
Rewinder (outer) Ø:	up to 200 mm
Core (inner) Ø:	38.1 / 76.2 / 101.6 mm (1.5 / 3 / 4")

3) Depending on the dispensing edge width.

Label sensor

Distance to peel edge	
L-shape dispensing edge:	19 mm
V-shape dispensing edge:	77 mm
Transmission sensor:	Wenglor OPT242-P800 optical, NPN

Power supply

System voltage:	
ALS 20X	110 V (AC) at 60 Hz power frequency (permissible tolerance ±10%) 230 V (AC) at 50 Hz power frequency (permissible tolerance ±10%)
ALS 256	100-240 V (AC) at 50-60 Hz power frequency (permissible tolerance ±10%)
Power consumption:	
ALS 20X	max. 460 VA
ALS 256	max. 560 VA
Fuses:	
ALS 20X	F1, F2: T5AH 250 V ⁴⁾
ALS 256	Fuses integrated in the power supply ⁵⁾

4) For more information on fuses, see section "Replacing fuses" on page 47.

5) Not accessible for user or service technician.

Electronics

Processor:	32 Bit CPU MIPS Core
RAM:	16 MB
ROM:	4 MB
Control panel:	graphical display with 128 x 32 pixels, 2/4 lines, 5 buttons

Interfaces

Sensor interfaces for external sensors	(plug in each case 4-pin M12)
Label sensor:	Wenglor OPT242-P800 optical, NPN, 24 V, controllable sensitivity
Alternative label sensor:	PNP/NPN, 24 V
Product sensor:	PNP/NPN, 24 V
APSF-sensor (Rotary encoder):	single-phase/two-phase, PNP/P-P, 24 V, max. 20 kHz
Stock sensor:	PNP, 24 V
Internal sensor interfaces:	
Material unwinder	Light barrier
Pressure roller	not used
Dancer arm	bi-phase light barrier encoder
PLC interface	Sub D15, optically insulated, optionally via two 8-pin M12 (separate inputs/outputs in each case)
Outputs:	4x PNP, 24 V, a maximum of 500 mA/channel, total permissible output current: 1500 mA
Inputs:	3x PNP/NPN, 24 V

Data interfaces:

Serial:	RS232C (Sub-D9), max. 115 200 Baud
Ethernet:	10/100 BaseT (RJ45)
USB:	Device V1.1 (USB B), 'Full speed' operating mode, 12 MBit/s
CF card:	Slot for 1 CompactFlash card
Control panel interface:	RS 485 (Mini DIN 6 connection) for remote control

Internal Interfaces

RFID	Connection for RFID read/write unit (special equipment) ⁶⁾
Applicator Interface	Connection for Applicator Interface (AI) board (special equipment)
Connector for additional motor driver	not used

6) Not yet available

Status messages, test functions, product profiles

Automatic halt, if	... the label roll is spent or no gap was found. ...the max. admissible number of missing labels is reached.
Test functions:	Automatic diagnostics check when switched on Output of system data via data interface
Status indicators:	Label counter Operating hours counter
Storage locations for product profiles:	up to 16

Dimensions

Width x height x depth: ⁶⁾

ALS 204	492 x 488 x 353 mm
ALS 206	492 x 488 x 403 mm
ALS 256	492 x 488 x 403 mm

Weight:

ALS 204	36 kg
ALS 206	38 kg

6) Measurements without the dispensing edge bracket and dispensing edge

Environmental conditions

Operating temperature:	5 to 40 °C
Humidity:	30 to 85%, (non-condensing)
Noise (at a distance of 1 m):	72 dB(A)
Protection class:	IP 21 IP 65 special equipment for ALS 20X

Integration

Mounting positions:	side / bottom / rear
Labelling positions:	top / side / bottom
Dispensing edges:	V-shape L-shape fixture 90° pivoting, for all L-shape types (4" L-shape disp. edge: material width up to 100 mm only)

Certificates

- CE, TÜV/GS, FCC, CCC, GOST, NRTL, US/CA
- The *regulation DIN EN 55022* demands for class A devices the following text to be printed in the manual:

„WARNING: This is a class A product. In a domestic environment this product may cause radio interference in which case the user may be required to take adequate measures.“

- The *FCC regulation* demands the following information text for class A devices:

„NOTE: This equipment has been tested and found to comply with the limits for a Class A digital device, pursuant to Part 15 of the FCC Rules. These limits are designed to provide reasonable protection against harmful interference when the equipment is operated in a commercial environment. This equipment generates, uses and can radiate radio frequency energy and, if not installed and used in accordance with the instruction manual, may cause harmful interference to radio communications. Operation of this equipment in a residential area is likely to cause harmful interference in which case the user will be required to correct the interference at his own expense“

2.1 OVERVIEW

2.1.6 Design models

The ALS 20X and ALS 256 label dispensers are available in two designs for differing conveyor belt directions.

Right-handed version

- The products are transported from left to right [9].
- The dispensing edge is located on the right side.
- Abbreviation: RH

Left-handed version

- The products are transported from right to left [10].
- The dispensing edge is located on the left side.
- Abbreviation: LH

i The label dispenser operation described in this manual is based on the right-handed version. The left-handed version is only taken into account if the explanations or figures of the designs differ significantly.

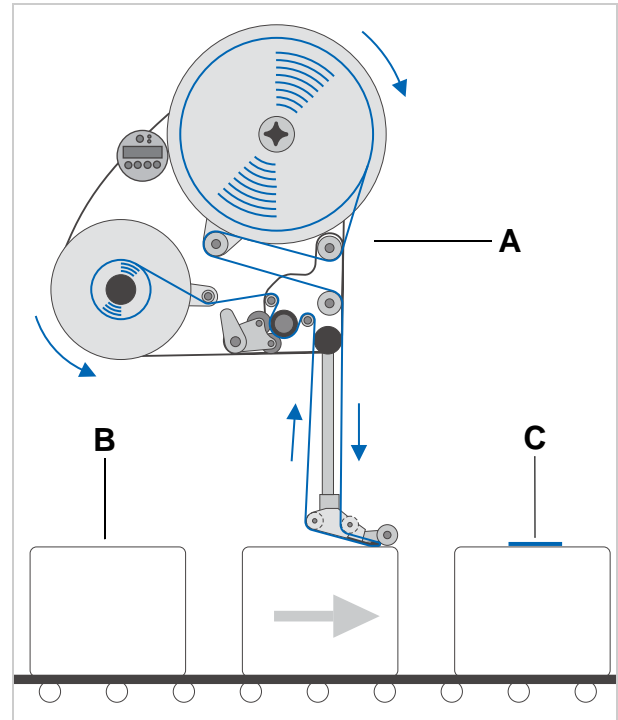

[9] Right-handed version
A ALS 20X
B Product on the conveyor belt
C Labelled product

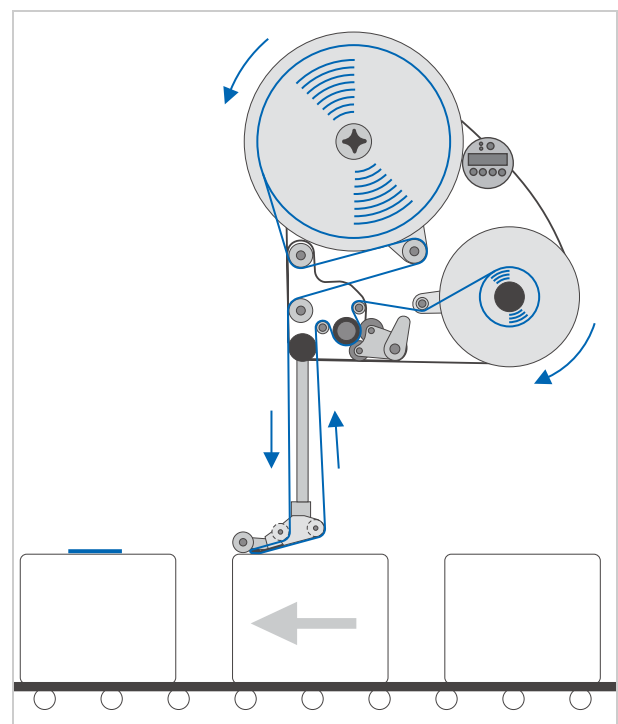

[10] Left-handed version

2.2 OPTIONS

External control panel

- An external control panel can be connected in addition to the integrated control panel.
- An external control panel is useful if the standard control panel is difficult to access due to the position in which the unit is installed.



[11] External control panel

Fixed dispensing edge

- The dispensing edge has a fixed connection to the brackets.
- To adjust the vertical position, lift/lower the entire device.
- The slope angle can be adjusted by rotating the brackets (see the service manual for further details).

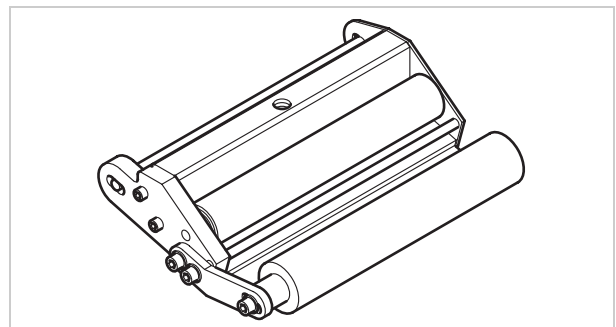

[12] Standard dispensing edge

Swivelling dispensing edge

- The position of the dispensing edge can be adjusted vertically.
- The device need not be moved to adjust the position of the dispensing edge; the device's mounting need not be dismantled.

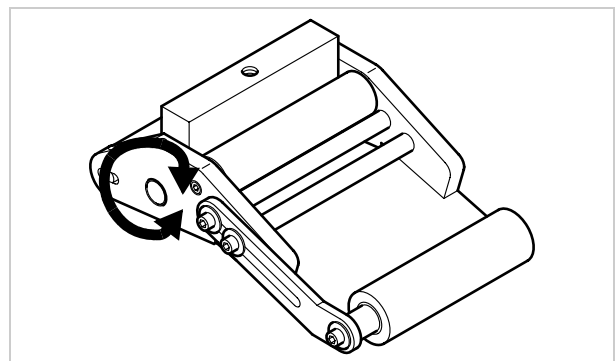

[13] Swivelling dispensing edge

Spring-loaded dispensing edge

- The dispensing edge is pivoted. A torsion spring in the dispensing head presses the dispensing edge downwards and onto the surface of the product.
- Allows compensation for height differences between the products or on the product surface.

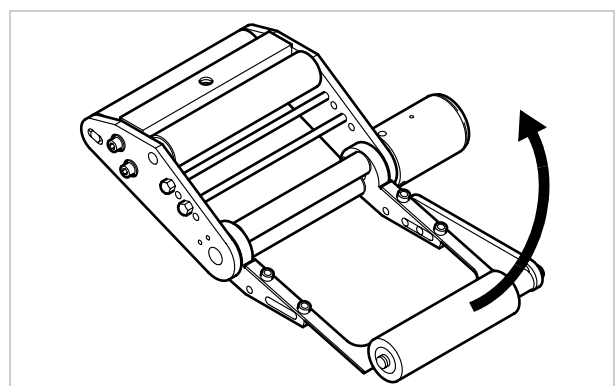

[14] Spring-loaded dispensing edge

2.2 OPTIONS

Pneumatic dispensing edge

- The dispensing edge is pivoted in the dispensing head. Compressed air presses the dispensing edge onto the surface of the product.
- Allows compensation for height differences between the products or on the product surface.

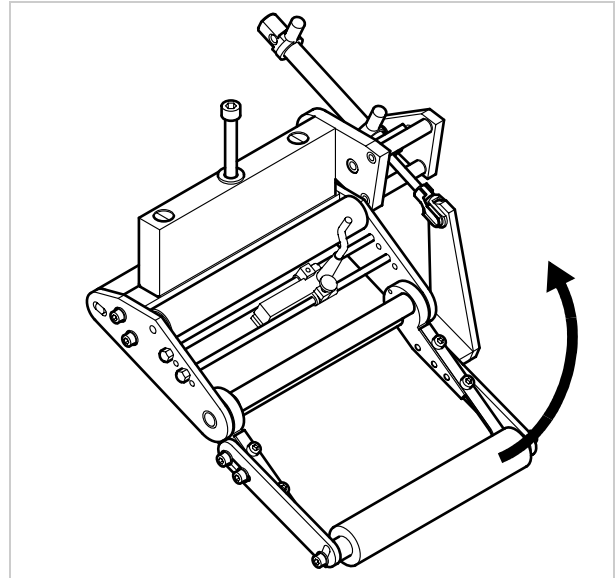

[15] Pneumatic dispensing edge

V-shape dispensing edge

- An alternative for applications which do not leave enough space for the standard dispensing edge holder, which juts out to the bottom side.
- Is attached directly to the machine

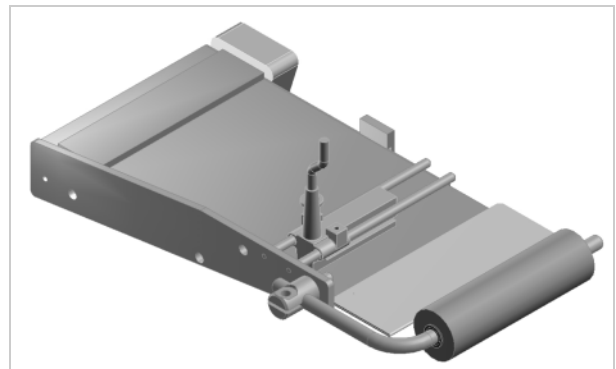

[16] V-shape dispensing edge

Adjustable dispensing edge holder

Enables a vertical fine adjustment of the dispensing edge towards the product without moving the machine.



[17] Adjustable dispensing edge holder (pictured red resp. dark gray)

2.2 OPTIONS

Outer Diameter control sensor

The outer diameter control sensor (OD sensor) triggers a warning, if the label roll outer diameter falls below a certain, adjustable value.

Printer

- If necessary, you can mount a hot stamp printer (not available from Avery Dennison) onto the holder brackets of the dispensing edge.
- Example of use: Printing consecutive numbers onto labels.

Applicator

If it is not possible to label directly from the dispensing edge, you can fit an applicator to the label dispenser. Various types of applicators are available that depend on the given requirements.

Simple applicators can be controlled directly via the PLC signal interface [5G] that is available as standard.

Applicator interface

Additional board [5H]; allows almost all types of applicators to be controlled.

Dust/Splash guard

Available only for ALS 20X.

Additional sealing of the electrical connections and of the housing fulfils the requirements of the IP65 protection class [19].

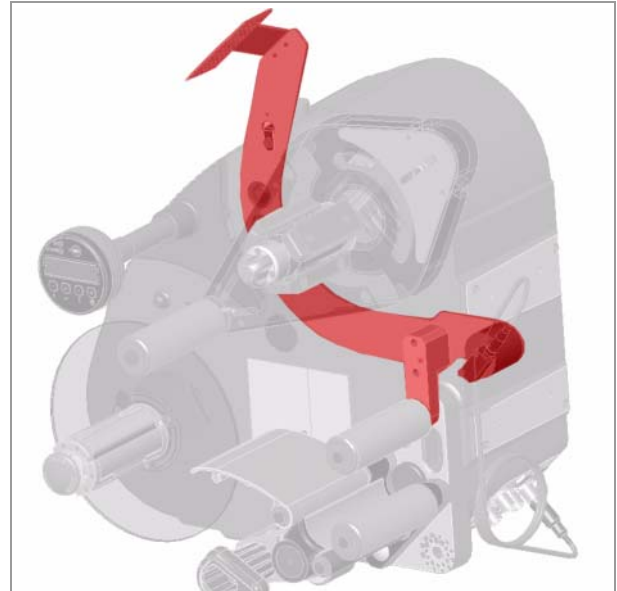

[18] OD sensor (pictured red resp. dark gray)

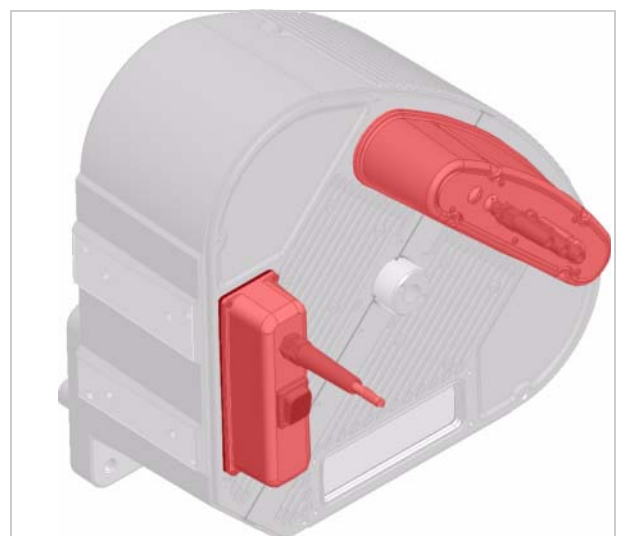

[19] Dust/splash guard of the electrical connections (pictured red resp. dark gray)

2.3 OPERATING MODES

2.3.1 Dispensing mode

This is the operating mode of the unit when switched on. You can carry out the functions listed below.

- i** If text such as 'Prof 5 xxxxxxxx' is displayed instead of 'ONLINE':
- The 'xxxxxxx' product profile (memory location 5) is activated.
 - For more information, see the 'Using product profiles' section.

Stopping/Continuing the dispensing mode

Stopping the dispensing mode:

- Press the  button.
- Display:

ONLINE	
Stopped:	xxx

Continuing the dispensing mode:

- Press the  button.

Changing the counter reading

- Set the counter reading using the MACHINE SETUP > Dispense counter function.

Starting the unit in configuration mode

To start the unit in configuration mode:

- Set MACHINE SETUP > Turn-on mode to 'Offline'.

Counting labels backwards

To count dispensed labels backwards from a starting value to zero:

- Set LABEL SETUP > Stop count. mode to 'Enabled'.
- Use the LABEL SETUP > Label stop quan. function to define the starting value.

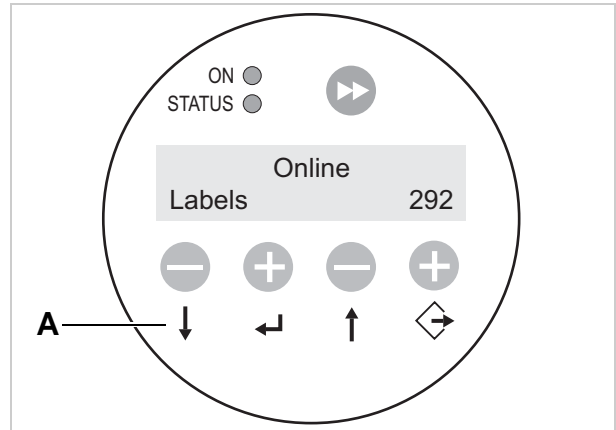

[20] Control panel in dispensing mode (292 labels dispensed)
A Explanation of buttons in dispensing mode

Online settings

The machine is in dispensing mode.

To switch to the online settings mode:

→ Press the  button.

- The display shows the dispensing speed [21A] and the start offset [21C].
- The button assignments are as shown *on the buttons*.
- You can increase ('+' button) or lower ('-' button) both settings in the dispensing mode [21D].

Dispensing speed:

- Setting range:
ALS 204: [2.0...40.0] m/min
ALS 206: [2.0...30.0] m/min
- Display *fix*: The dispensing speed is constant.
- Display *var*: The dispensing speed automatically adjusts to the speed of the conveyor belt ('speed adaption').



Start offset:

- Setting range: [0.0...999.9] mm
- The start offset indicates the distance between the product sensor and the dispensing edge.

Dispensing manually

- To manually trigger the dispensing of individual labels:
→ Press the  button.
- Dispensing speed: As specified in the setting (see above).

To switch back to dispensing mode:

→ Press the buttons  + .

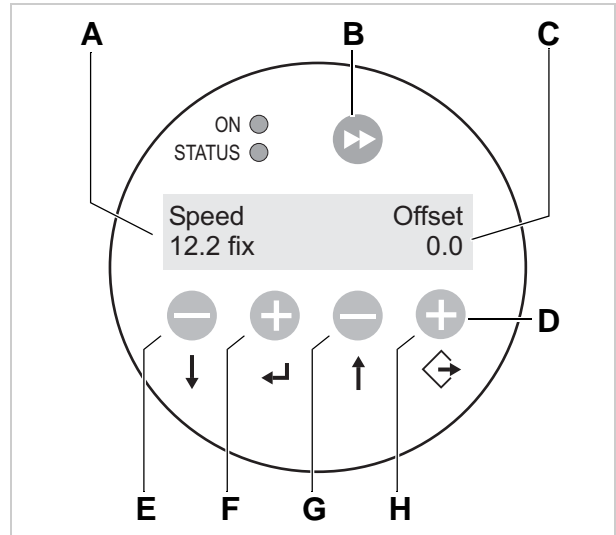

[21] Control panel in the online settings mode

- A Dispensing speed display (here: 12.2 m/min constant)
- B Dispense label button
- C Start offset display (here: 0 mm)
- D Explanation of buttons in online settings mode
- E Button to lower dispensing speed
- F Button to increase dispensing speed
- G Button to lower start offset
- H Button to increase start offset

2.3 OPERATING MODES

2.3.2 Configuration mode

The machine is in dispensing mode.

Switching to configuration mode:

- Press the  button twice.
- Display:

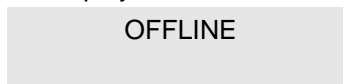

- Press the  button.
- Display:

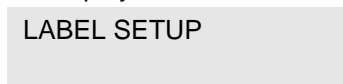

- LABEL SETUP is the name of the first menu that is currently active.
- In configuration mode, the button assignments are as shown *below the buttons*.

Function of the double-arrow button

To dispense individual labels:

- Press the  button *briefly* (less than two seconds).
- Dispensing speed: As specified in the configuration; 'Speed Adaption' is not active.

To automatically calibrate the label length:

- Hold down the button  for a while (longer than two seconds).

Menus

In configuration mode, you have access to several menus providing a fixed sequence of functions that can be carried out.

You can set the unit so that some of the menus are not shown.

Figure [22] shows the button functions for switching between the individual menus and for leaving them.

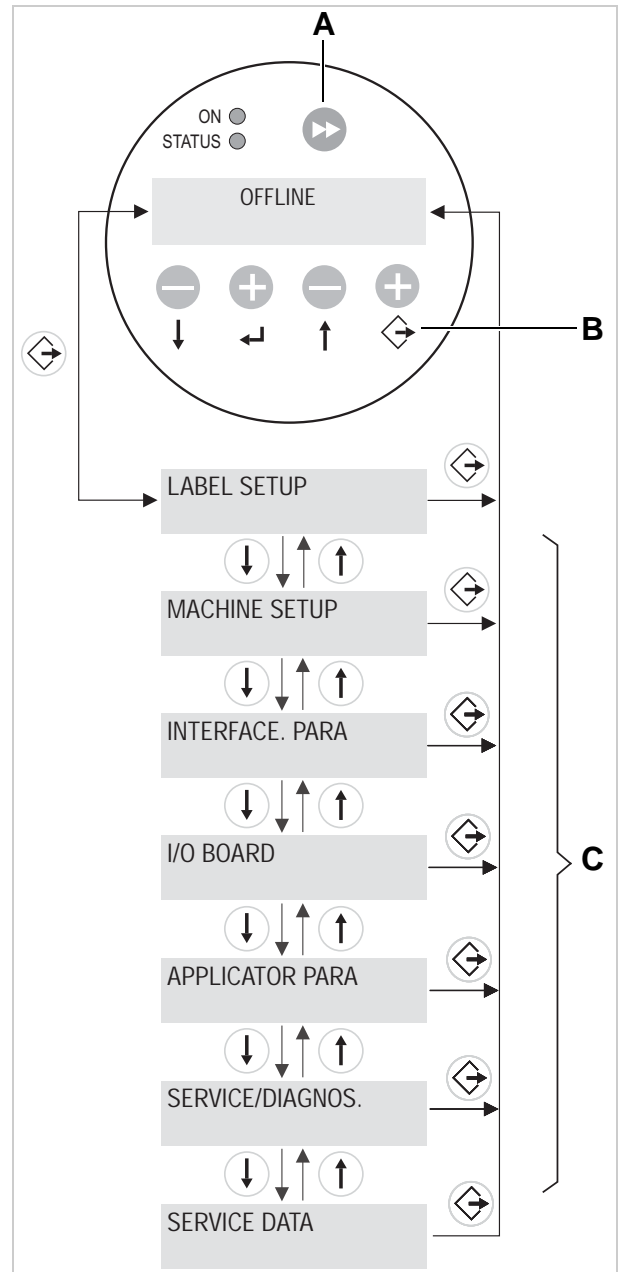

[22] Menu selection and button functions in configuration mode.
A Button for triggering a dispensing procedure and for starting the measurement of lengths.
B Explanation of buttons in configuration mode
C Menus

2.3 OPERATING MODES

Functions

Every submenu contains functions for setting the unit controls.

Figure [23] shows the button functions for changing settings using the MACHINE SETUP > Language function as an example.

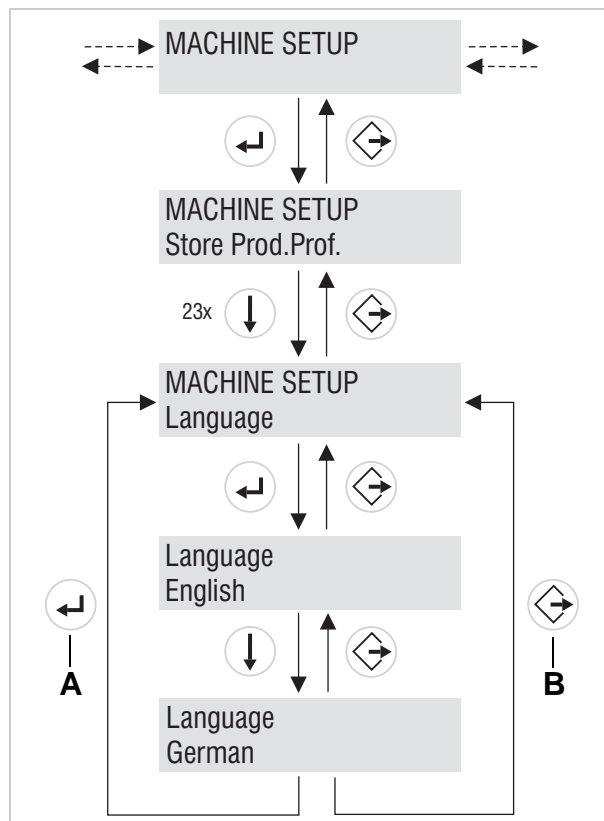

[23] Button functions for setting the MACHINE SETUP > Language function.

- A Button to 'Accept changes'
- B Button to 'Cancel changes'

2.4 FUNCTION DESCRIPTIONS

2.4.1 Function overview

LABEL SETUP	MACHINE SETUP	INTERFACE PARA	PLC INTERFACE	APPLICATOR PARA
Load prod. profil	Store prod.prof.	> EASYPLUGINTERPR	End dispense mod	Applicator type
Dispense speed	Del. prod.profil	Interface	Disp. end delay	Apply mode
Slew speed	Sensor Adjust	Spooler mode	Disp. end time	Blow on time
Label pitch	Dispense counter	Printer ID no.		Restart delay
Lab. stop offset	Factory settings	Spooler size		Position timeout
Start offset	Parameter to CF	Interface delay		Start error stop
Product length	Auto Sensor Adj.			
Miss. label tol.	Sensor Adjust	> COM1 PORT		
Stop count. mode	Speed Adaption	Baud rate		
Label stop quan. ¹⁾	Encoder Type	No. of data bits		
	Encoder Resol.	Parity		
	Encoder Diameter	Stop bits		
	Tandem Operation	Data synch.		
	Tandem Synch.	Frame error		
	Tandem Distance			
	Light sens. type	> NETWORK PARAM.		
	Labelsens. In.Typ	IP Addressassign.		
	Act. apl.interf.	IP address		
	Startsens. In.Typ	Net mask		
	Start disp. mode	Gateway address		
	Start error stop	Port address		
	Turn-on mode	Ethernet speed		
	Language	MAC Address		
	Access authoriz.	SNMP Agent		
	Material end err	FTP server		
	OD Sensor	WEB server		
		WEB display refr		
		DHCP host name		

1) Appears only when LABEL SETUP > Stop count. mode = 'Enabled'

[24] Function menu ALS 20X and ALS 256 – Part 1.

2.4 FUNCTION DESCRIPTIONS

SERVICE/DIAGNOS.	SERVICE DATA	(continued)
Sensor Test	> MODULE FW VERS.	> MEMORY DATA
Compactflashtest	System version	Ram memory size
Test functions		Flash mem size
	> OPERATIONAL DATA	Default values
	Service operations	
	Material feed	
	Dispensing cycl.	
	Operation time	
	> POWER SUPPLY DATA	
	Type	
	> CPU BOARD DATA	
	CPU identifier	
	PCB Revision	
	FPGA version	
	MAC Address	
	Serial number	
	Production date	
	PCB part number	
	Board part numb.	
	> DISPLAY DATA	
	Remote Disip. vers	
	> CF CARD SLOT	
	Card in slot	
	> PERIPHERAL DATA	
	Applicator int. ¹⁾	

1) Only with integrated applicator interface.

[25] Function overview in the ALS20x menu – Part 2.

2.4 FUNCTION DESCRIPTIONS

2.4.2 Notes on function descriptions

These operating instructions only describe those functions that are necessary for operating an ALS 20x that has been configured and set up. These functions are highlighted in grey in the function overview.



Only qualified service technicians may change the settings of the other functions. These functions are described in the service manual.



The settings range or the individual settings for a function are shown in square brackets.

- The default value is italicised for functions that have individual settings.
- Settings that consist of several words are shown in quotation marks.

2.4.3 LABEL SETUP menu

Load prod. profil function:

- Loads product profiles from the internal database.
- Product profiles contain product-specific settings.
- You can select a maximum of 16 product profiles.
- You can only select product profile numbers that have profiles already stored for them.

Dispense speed function:

- The speed at which the label is dispensed
- Setting range:
 - ALS 204: [0.0...40.0] m/min; default: 10.0
 - ALS 206: [0.0...30.0] m/min; default: 10.0
 - ALS 256: [0.0...50.0] m/min; default: 10.0

Slew speed function:

- Feed speed during initialisation
- Setting range:
 - ALS 204: [0.0...40.0] m/min; default: 1.0
 - ALS 206: [0.0...30.0] m/min; default: 1.0
 - ALS 256: [0.0...50.0] m/min; default: 1.0

Label pitch function:

- Label pitch = label length+space
- Setting range: [5.0...600.0] mm

Lab. stop offset function:

- Stop position of the label on the dispensing plate
- Setting range: [0.0...999.9] mm; default: 20.0

Start offset function:

- Distance between the product sensor and the top of the dispensing plate
- Setting range: [15.0...999.9] mm; default: 15.0

Product length function:

- Setting range: [0.0...1999.9] mm; default: 0.0

Miss. label tol. function:

- Missing label tolerance
- The maximum permissible number of successive missing labels on the label strip
- Setting range: [0...10] mm; default: 1

Stop count. mode function:

- Settings: [enabled, *disabled*]

Enabled: Dispenser counter counts backwards, starting with the value that has been set using the **MACHINE SETUP > Dispense counter** function. When the counter reaches zero, no further labels are dispensed.

Disabled: The dispenser counter counts forwards, which means that the dispenser counter is incremented with each label that is dispensed.

2.4.4 MACHINE SETUP menu

Start error stop function:

- Determines how the machine responds in the event of a product start error. A product start error occurs when a new start signal arrives before the current dispensing cycle has ended.
- Settings: [On, Off]
 - On: Start errors are issued. If a start error occurs, the device stops and displays a relevant error message.
 - Off: Start errors are ignored.

Turn-on mode function:

- The operating mode of the unit after it is turned on.
- Settings: [*Online*, Offline]
 - Online: Dispensing mode
 - Offline: Configuration mode

Language function:



- Language of the displayed text
- Settings: [*English*, French, German, Spanish, Italian, Dutch, Danish]

2.4 FUNCTION DESCRIPTIONS

2.4.5 SERVICE DATA menu



If the displayed text is longer than the line length of the display:

- Press the  button to move the text to the left.
- Press the  button to move the text to the right.

> MODULE FW VERS. submenu

System version function:

- Shows the firmware version of the labeller

> OPERATIONAL DATA submenu

Service operations function:

- Displays the number of service operations that have been implemented.
- Increment the counter using the `SERVICE/DIAGNOS. > Service` function.
- Maximum number: four billion

Material feed function:

- Displays the entire material feed, in other words, the 'distance covered' by the drive roller.
- Maximum number: four billion metres

Dispensing cycl. function:

- Counts the number of dispensed labels.

Operation time function:

- Displays the entire on-time

> POWER SUPPLY DATA submenu

Type function:

- Displays the type of power supply

> CPU BOARD DATA submenu

CPU identifier function:

- Displays the identification of the processor in use.

PCB Revision function:

- Displays the layout revision and the part number of the CPU board.

FPGA version function:

- Displays the FPGA version.

MAC Address function:

- Displays the MAC address, which is a fixed and unique board address for the Ethernet interface and is programmed by the manufacturer of the board.

Serial number function:

- Displays the serial number that is programmed by the board manufacturer.

Production date function:

- Displays the production date of the CPU board

PCB part number function:

- Displays the part number of the unpopulated board.

Board part numb. function:

- Displays the part number of the populated board

> DISPLAY DATA submenu

Remote Disp.vers function:

- Displays the version of the external operator panel

> CF CARD SLOT submenu

Card in slot function:

- Tests whether the CF card is inserted in the device's card slot.
- If the result is 'Yes', then the CF card is in the slot.
- If the result is 'No', then there is no CF card in the slot.

> PERIPHERAL DATA submenu

Applicator int. function:

- The function is only available when an applicator interface is integrated.
- Displays the firmware version of the applicator interface.

> MEMORY DATA submenu

Ram memory size function:

- Displays the amount of RAM available.

Flash mem size function:

- Displays the amount of Flash memory available.

Default values function:

- Values that are used for a factory reset (standard or 'User defined', see `MACHINE SETUP > Default values`).

3.1 ELECTRICAL CONNECTIONS

3.1.1 Power supply connection

WARNING!

This machine operates using mains voltage! Touching live electrical parts may expose you to hazardous electrical currents and may lead to burns.

- Make sure that the device is switched off before you connect the power cable.
- (ALS 20X) Only operate the device with the mains voltage set on the voltage selector switch.
- (ALS 20X) Ensure that the unit is set to receive the mains voltage supplied by your electricity provider.
- (ALS 256) Only operate the device using the system voltage indicated on the nameplate.
- Only connect the unit to a grounded power socket fitted to authorised standards.
- The power cable should not be more than 3 m long.

The device is *only completely disconnected from the mains if the power cable is unplugged*. Therefore:

- Make sure the power supply socket is accessible.
- In case of emergency, switch off the device and disconnect the power cable!

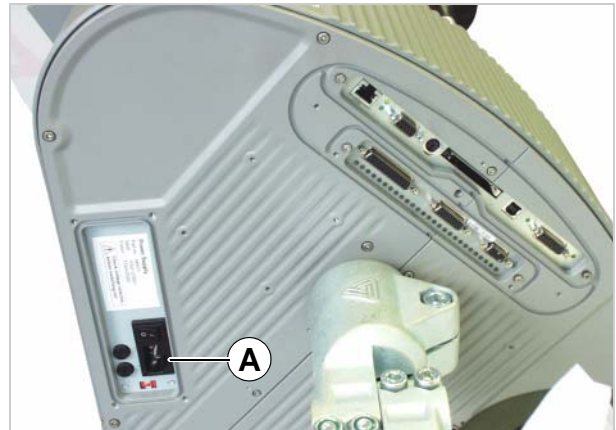

[26] Power supply (A) on the ALS 20X

3.1 ELECTRICAL CONNECTIONS

Checking the power supply setting



ALS 256: A power supply setting is not required.

The ALS 20X Label Dispenser is suitable for operation with a power supply of 230 V (AC) or 110 V (AC).



If you are unsure of what mains voltage your local electricity supplier provides, refer to a qualified service technician.

→ Check to see that the voltage that has been set conforms to the local mains voltage.

Switch setting	Permissible mains voltage
115	100–120 V (AC)
230	200–240 V (AC)

[28] Permissible mains voltages for both positions on the voltage selector switch.

Changing the voltage setting:

- Make sure that the power cable is disconnected.
- Slide the switch [27A] to the respective opposite position.
- Insert a small screwdriver into the groove [27B] and move the red insert horizontally to the opposite stop position (to the left in Figure [27]).

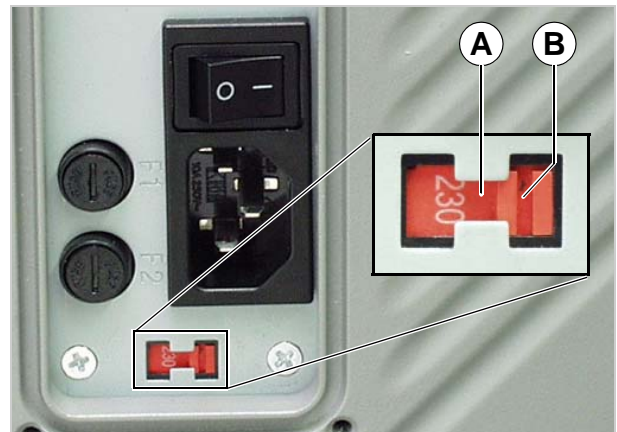

[27] Voltage selector switch on the ALS 20X (set to 230 V in the figure)

Connecting the power cable.

- Make sure that the power switch [29A] is set to 'O' (off).
- Using the supplied power cable, plug the unit into a socket connected to the mains supply.



For more information on fuses, see section "Replacing fuses" on page 47.

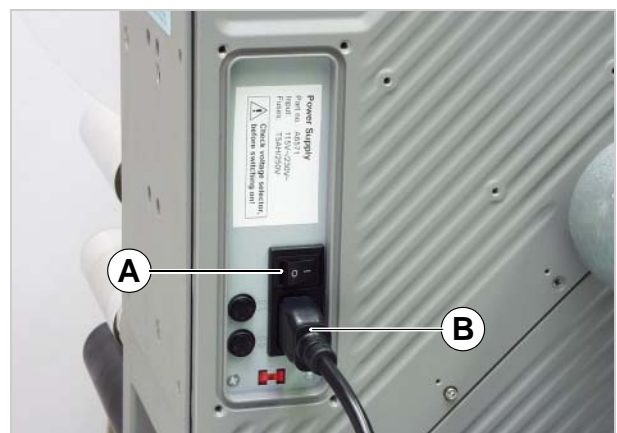

[29] Power cable (B) plugged in.

3.1 ELECTRICAL CONNECTIONS

3.1.2 Connecting sensors

→ Check whether the required sensors are connected before turning on the unit [30].

The minimum required sensors:

- Label sensor (installation location: dispensing edge)
- Product sensor (installation location: conveyor belt)

Additional optional sensors:

- Rotary encoder (required for speed adaption)
- External outer diameter checking sensor (provides advance warning of the end of a label roll)
- Alternative label sensor; for example, capacitive sensor, used to detect transparent labels.

 You can find further information regarding suitable sensor types, pin assignments, and so on in the service manual.

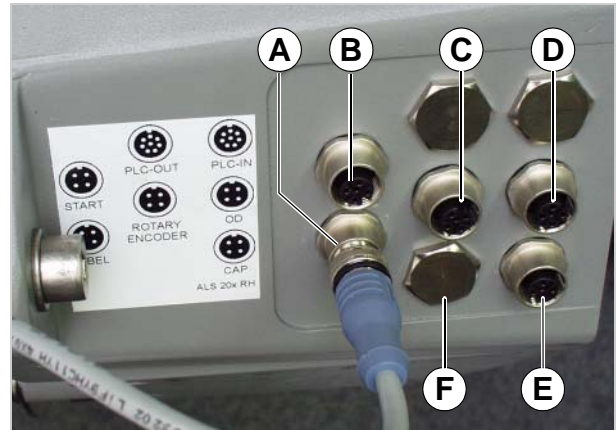

[30] Sensor connectors:

- A Label sensor
- B Product sensor
- C Optional: Rotary encoder
- D Optional: Roll diameter check
- E (ALS 20x) Optional: Alternative label sensor
- F (ALS 256) Optional: Alternative label sensor

3.2 INSERTING LABEL MATERIAL

3.2.1 Prerequisites

- The label dispenser is turned off at the main switch [31A] (switch set to 'O').
- Check that the safety installations are working properly.
- Inspect the machinery for any visible damage. Report any defects immediately.
- Remove any unnecessary materials and objects from the operating area of the unit.
- Make sure that only authorised persons are within the operating range of the machine.
- Use the required personal protective equipment correctly; for example, wear a hairnet, safety glasses.

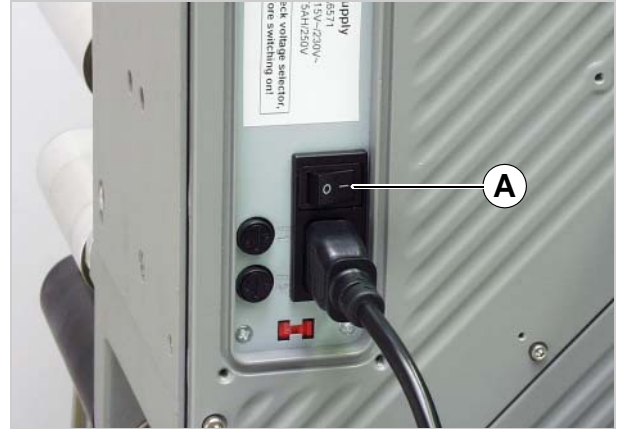

[31] Main switch on the housing.

3.2 INSERTING LABEL MATERIAL

3.2.2 Inserting a label roll



WARNING!

Risk of injury due to moving and rapidly rotating parts!

- Before inserting the label roll, ensure that the device is turned off at the main switch.
- Do not under any circumstances turn the device on before the label strip is threaded in completely.

Removing spent backing paper

Assuming backing paper has gathered on the rewinder [32A] :

- Press the release button [32B].
- The tensioning mechanism of the rewinder is slackened.
- Remove the rewound backing paper.

Removing glue residue

- If necessary, clean the following components:
 - Dispensing plate
 - Deflection rollers
 - Drive rollers
 - Pressure roller
- Follow the directions provided in section “Maintenance and cleaning” on page 47.

Inserting a new label roll

- Push the material roll [33A] onto the unwinder as far as it will go.
- Rotate the rotary knob [33B] in a clockwise direction until the label roll sits tightly.
- Run the label strip around the dancer arm as shown in the figure [33C].

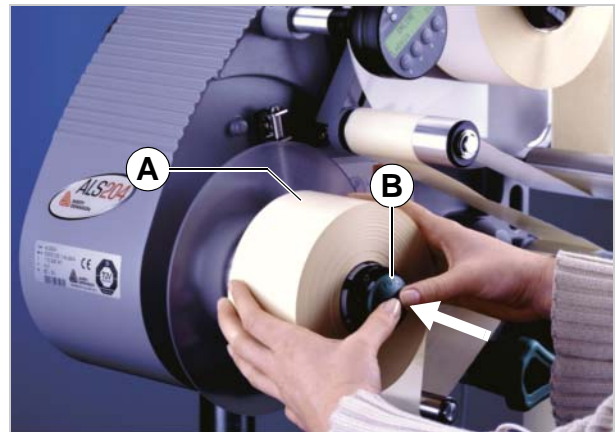

[32] A Rewound backing paper
B Release button
C Backing paper path

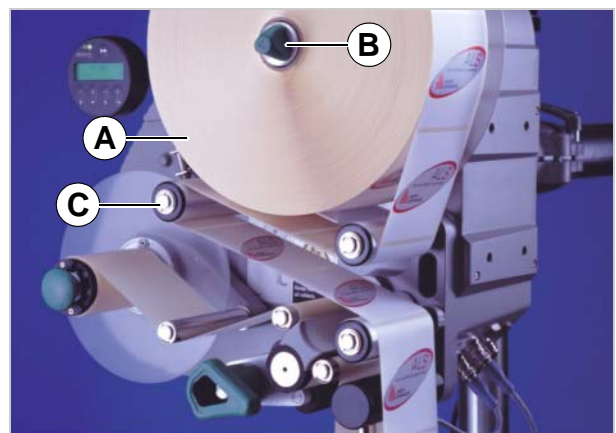

[33] Inserting the material roll – Part 1.

3.2 INSERTING LABEL MATERIAL

3.2.3 Threading the label roll

Threading guide

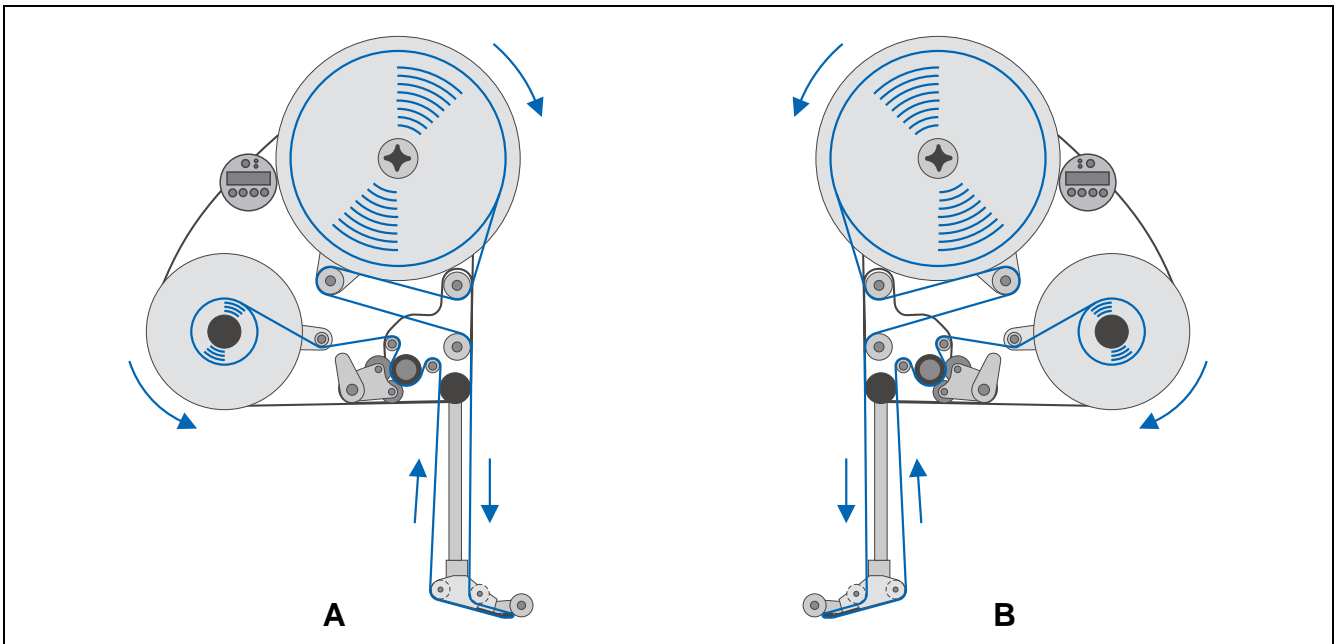

[34] Threading guide for label rolls with labels facing outwards.
A Right-handed version

B Left-handed version

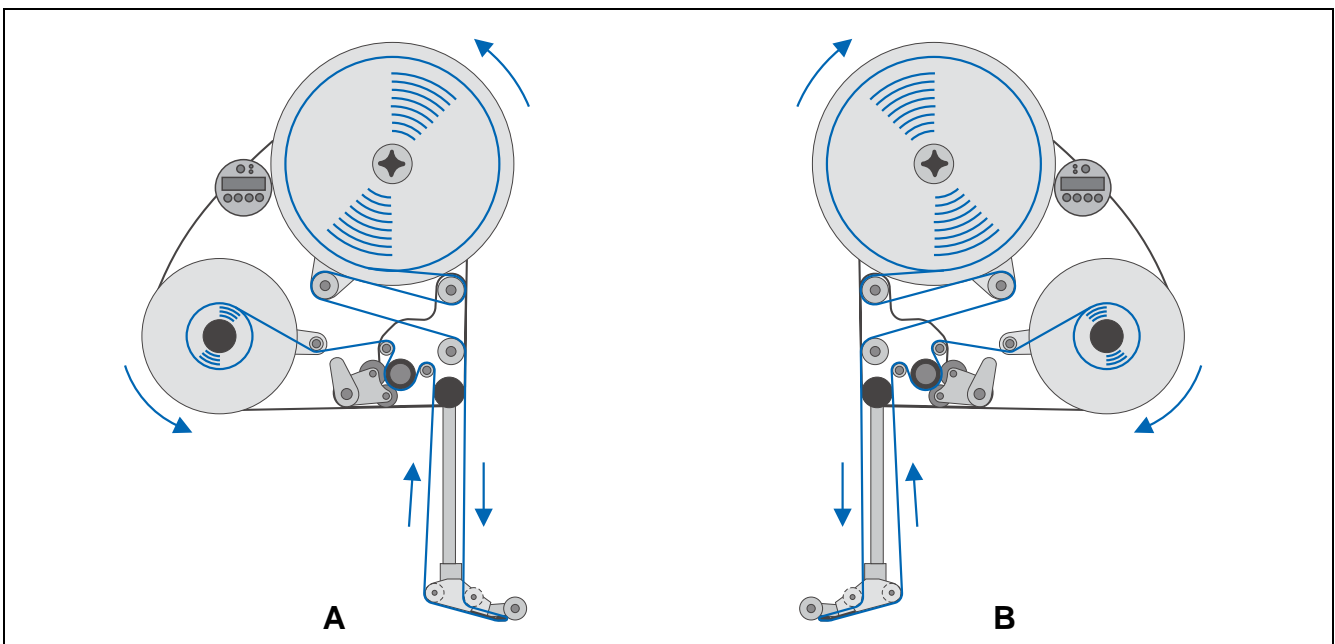

[35] Threading guide for label rolls with labels facing inwards.
A Right-handed version

B Left-handed version

3.2 INSERTING LABEL MATERIAL

Threading the label roll at the dispensing edge

- Unroll around 1 m of label strip and remove the labels from it.
- Pass the backing paper around the first deflection roller [36A] and through the slot in the sensor [36B].
- Feed the backing paper under the pressure roller [36C] to the dispensing plate [36D].
- Feed the backing paper around the dispensing plate to the second deflection roller [36E].

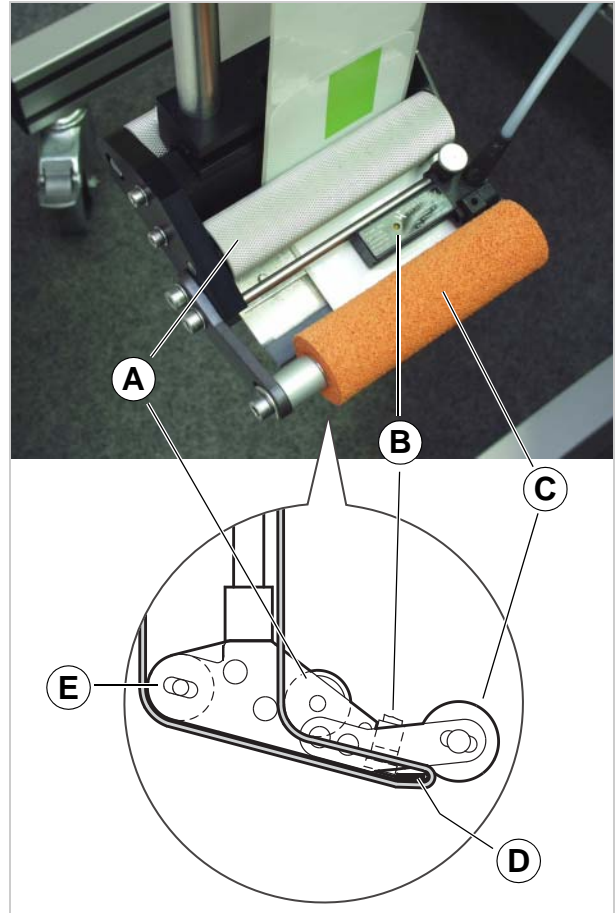

[36] Path of the label strip at the dispensing edge.

- A 1st deflection roller
- B Label sensor
- C Pressure roller
- D Dispensing plate
- E 2nd deflection roller

3.2 INSERTING LABEL MATERIAL

Threading the label roll onto the drive roller

- Open the pressure roller. To do so, rotate the lever [37D] in a clockwise direction.
- Feed the backing paper around the deflection roller [37B], drive roller [37C] and the dancer arm [37A].
- Close the pressure roller. To do so, rotate the lever until it snaps in noticeably.

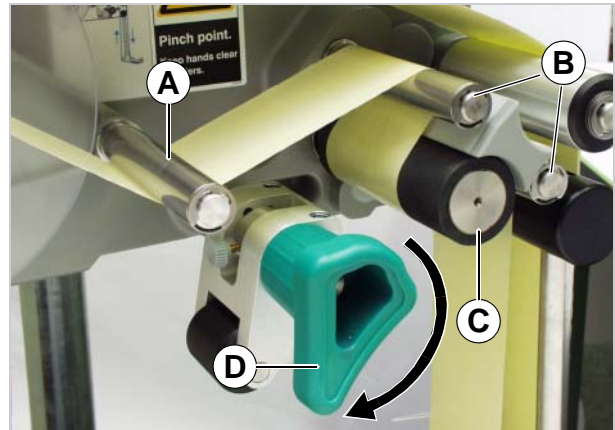

[37] Open the pressure roller.



[38] Close the pressure roller.

Fastening the label roll to the rewinder

- Clamp the backing paper to the rewinder as shown and tighten it [39].
- Manually rotate the rewinder by one turn.

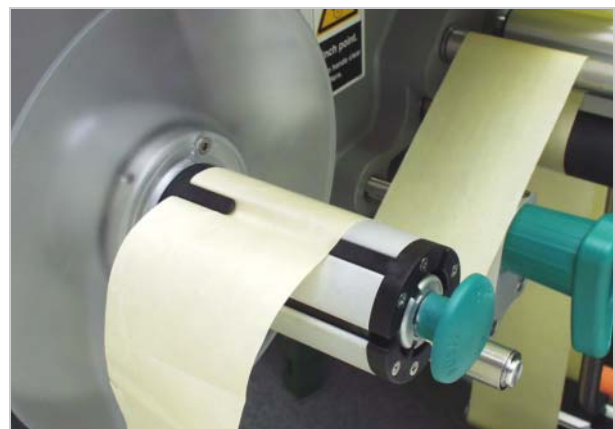

[39] Fastening the backing paper to the rewinder.

3.3 MECHANICAL SETTINGS

3.3.1 Adjusting the unwinder's core diameter

Tool:

- 3 mm hexagon (Allen) screwdriver

The unwinder can be adjusted with core adapters [40B] to fit the inner diameter of the label roll. The adapters must be fitted and dismantled in different ways depending on this diameter:

- 38.1 mm (1") core
 - Unscrew the screws [40A] (3 for each adapter) and remove the adapters.
- 76.2 mm (3") core
 - Screw on the adapters, as is shown in Figure [40].
- 101.6 mm (4") core
 - Screw on the adapters, as is shown in Figure [41].

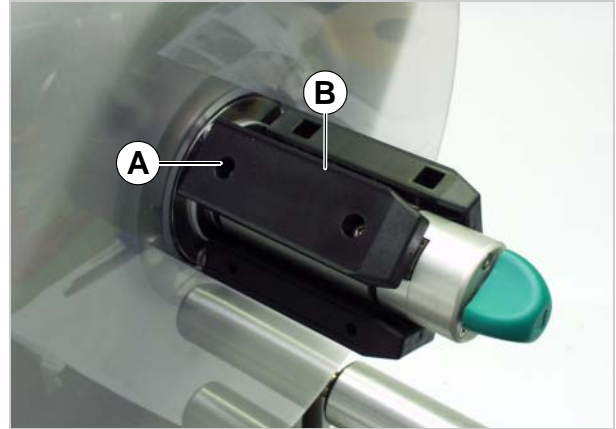

[40] Core adapter positions for a core diameter of 76.2 mm.



[41] Core adapter positions for a core diameter of 101.6 mm.

3.3.2 Positioning the pressure roller

- Open the pressure roller [42B]. To do so, rotate the lever [42C] until the roller snaps up.
- Release thumb screw [42A].
- Align the pressure roller over the backing paper so that it is centred.
- Close the pressure roller.
- Screw the thumb screw tight.

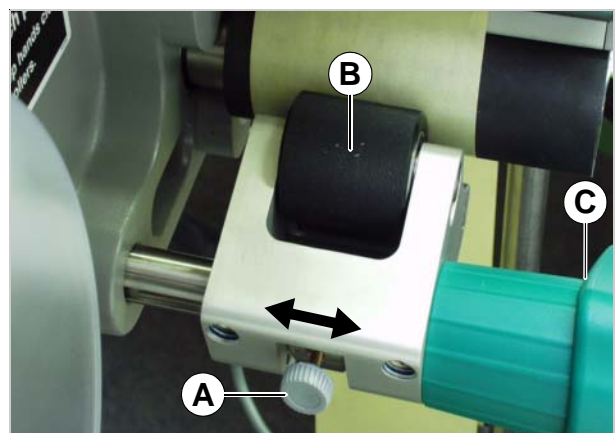

[42] Setting the position of the pressure roller (B).

3.3 MECHANICAL SETTINGS

3.3.3 Positioning the label sensor

- Release the thumb screw.
- Position the sensor along the axle in such a way as to allow it to register the spaces between the labels.



The LED [43A] lights up when the sensor is positioned over a label.

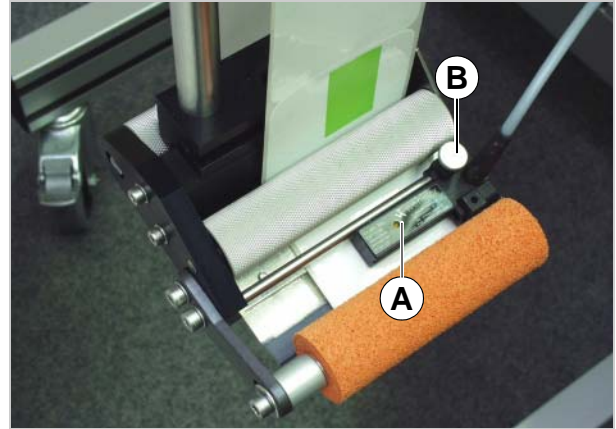

[43] Label sensor from Wenglor, model OPT242-P800

4.1 START-UP AND SHUTDOWN

4.1.1 Turning on the unit

- Set the main switch [44A] of the unit to 'I' (On).
- The following messages are displayed during the start process:

```
ALS204 RH:
  V 1.00
```

(machine type and firmware version)

```
Memory:      16 MB
Flashcard    48 MB
```

(the machine's RAM, as well as the CF card's memory, if a card is inserted)

```
ONLINE
Label        0
```

- Once switched on, the ALS 20x is in dispensing mode; in other words, triggering the product sensor will cause a label to be dispensed.
- You can find more information on the dispensing mode in the section "Spendebetrieb" on page 18.



[44] Main switch (A) of the ALS 20x

4.1.2 Starting label dispensing

Dispensing with a product sensor



Once switched on, the ALS 20x is in dispensing mode; this means that triggering the product sensor will cause a label to be dispensed.

Prerequisites:

- The label length must be specified.
- The product sensor must be connected.
- The sensors must be configured correctly (PNP/NPN).

Dispensing without a product sensor

It is also possible to trigger the dispensing process without a product sensor:

- The machine is in dispensing mode:
 - Press the  button.
- The machine is in configuration mode:
 - Press the  button *briefly* (less than two seconds).

4.1 START-UP AND SHUTDOWN

4.1.3 Stopping the dispensing process

- The machine is in dispensing mode:
- Press the  button.
- Display:

ONLINE	
Stopped:	xxx

- The dispenser stops.

4.2 CONFIGURATION AND MONITORING

4.2.1 Function menu settings

Label pitch

→ Switch to configuration mode

Calibrating the label pitch automatically:

→ Hold down the button  for a while (longer than two seconds).

Or: Enter the label pitch manually:

→ Measure the label pitch [45C].

→ Call the LABEL SETUP > Label pitch function.

→ Enter the measured value in millimetres.

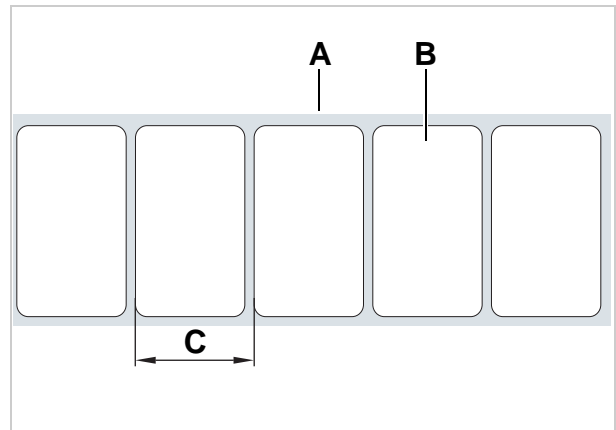

[45] **A** Label web
B Label
C Label pitch

Label stop position

Prerequisites:

– The label length must be specified.

The next label to be dispensed waits in the label stop position. Here it is useful if the label protrudes over the dispensing edge a little [46].



ALS 20X and ALS 256 labellers are pre-configured for use with the supplied label sensor. If this sensor is employed, the label stop position setting will only require minimal correction.

Correcting the default setting:

→ Call the LABEL SETUP > Lab. stop offset function.

→ Increase the value to increase the overhang or lower the value to reduce the overhang.

The value '0' will cause the label to stop with its front edge directly under the label sensor.

The front edge of the next label to be dispensed should be flush with the dispensing edge:

→ Enter the distance [46A] between the label sensor and the dispensing edge.

The front edge of the label to be dispensed should overhang:

→ Add the length of the overhang to the distance between the label sensor and the dispensing edge.

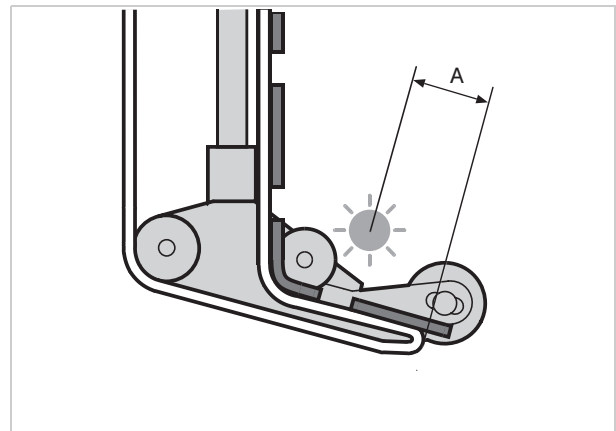

[46] Label stop position (A)

4.2 CONFIGURATION AND MONITORING

Dispensing speed

You can set the dispensing speed to a fixed value or you can configure it to automatically adjust to the speed of the conveyor belt (speed adaption). The second option requires you to connect a rotary encoder that measures and relays the conveyor speed to the dispenser.

Configuring a *fixed value*:

→ Use the two left buttons to set the speed in dispensing mode (online settings) (see “Online settings” on page 22).

Or use the function menu settings:

→ Call the LABEL SETUP > Dispense speed function and set the speed you require.

Configuring *speed adaption*:

→ Turn the function on by setting MACHINE SETUP > Speed Adaption to ‘Yes’.

→ Set MACHINE SETUP > Encoder Resol. and MACHINE SETUP > Encoder Diameter as appropriate for the employed rotary encoder.



– See the service manual for information on suitable rotary encoders.

4.2 CONFIGURATION AND MONITORING

Label position on the product

Prerequisites:

- The label length must be specified.
- The label stop position must be set.

Configuration in dispensing mode:

→ Use the two right buttons to set the start offset (see "Online settings" on page 22).

Or use the function menu settings:

→ Call the LABEL SETUP > Start Offset function and set the start offset.

- The label should be flush with the front edge of the product:
- Enter the distance between the product sensor and the dispensing edge [47A].

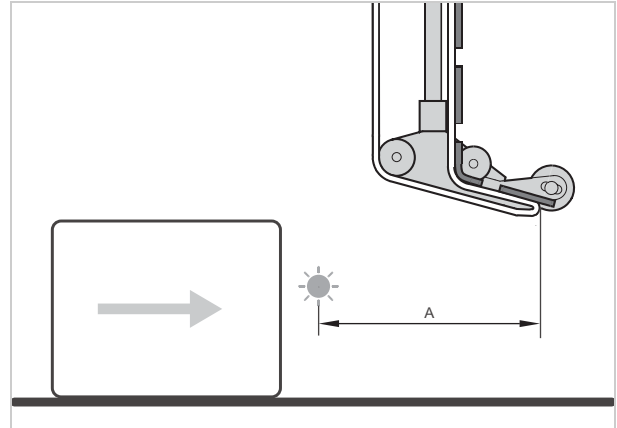

[47] Distance between the product sensor (left) and the dispensing edge (right).

- The label should be stuck at a distance from the front edge of the product:
- Increase the start offset by the distance [48A] to the product's front edge.

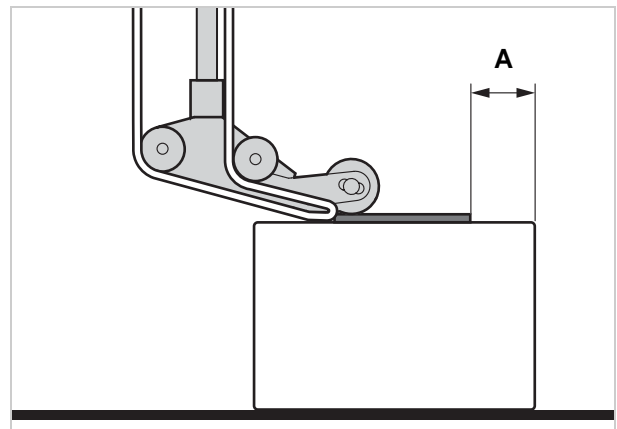

[48] Distance (A) between the label and the product's front

4.2 CONFIGURATION AND MONITORING

4.2.2 Monitoring functions

While in dispensing mode, an electronic controller monitors the following functions:

Missing labels

A label missing from the label roll does not normally affect the dispensing operation, because the label feed continues until a label's edge passes under the label sensor.

Nonetheless, it can be important that missing labels are reported. By configuring the function LABEL SETUP > Miss. label tol., you can specify whether an error message is triggered after one or several missing labels.

Material end

The following message appears when the material roll is empty:

Status num:	5002
Material end	

- The machine stops.
- Press the button  to delete the message.
- Remove the rewound backing paper.
- Insert a new material roll (see "Inserting label material" on page 32).

Material tear

If the material path tears, one of these two messages appears:

Status num:	5002
Material end	

Status num:	5140
Rewinder control	

- Which message appears depends on where the material path is torn.
- The machine stops.
- Press the  button.

4.3 USING PRODUCT PROFILES

4.3.1 What are product profiles?

Product profiles are memory locations that can store all the settings for the machine controls. For recurring production jobs, they allow you to quickly set the machine to the respective product.

- Number of memory locations: 16
- The memory locations are numbered. In addition, you can also enter a text identifier for each memory location (with a maximum of eight alphanumeric characters).

4.3.2 Loading a product profile



CAUTION!

Incorrect settings may lead to production problems and damage both the unit and the equipment.

→ **Only staff who are qualified and specially trained should set up product databases.**

→ Call the LABEL SETUP > Load prod. profil function.

- The following message appears when no memory location is occupied:

```
Load prod. profil
No setup avail.
```

- Only occupied memory locations are displayed.
- When memory locations are occupied, the memory location that was loaded last is displayed first:

```
Load prod. profil
Prof 1 xxxxxx
```

Above example: The profile with the 'xxxxxx' text identifier has been stored at the first memory location.

- Press the or the button until the profile you require appears.
- Press the button to load the profile.
- The unit restarts afterwards.
- Display after the restart:

```
Prof 1 xxxxxx
Label          0
```

(in dispensing mode, 'ONLINE' is replaced by the current profile name).

4.3.3 Storing a product profile

Selecting the memory location

- Call the MACHINE SETUP > Store prod.prof. function.
- Display shown when all memory locations are unoccupied:

```
Store prod.prof.
Prof 1 Product 1
```

- When memory locations are already occupied, the memory location that was last active is displayed:

```
Store prod.prof.
Prof 5*customer_xyz
```

- A '*' occurring after the memory location number indicates that the memory location is already occupied (here by the 'customer_xyz' profile).
- Press the or the button until you retrieve the memory location you require (1–16).
- Press the button to activate the memory location.
- The profile name flashes, and you can now replace the name using any text you choose.

Entering profile names

Accepting the profile name 'Product 1' without changing it:

- Press the button twice.
- The profile is saved.
- Display:

```
Store prod.prof.
Storing...
```

Changing a profile name:

- Press the button.
- Display:

```
Store prod.prof.
Prof x_
```

- The underscore marks the active position.
- Press the or the button to scroll through the available characters until the character you require appears.
- Press the button to accept the character.
- The underscore jumps to the next character.
- Enter the next character in the same way.
- When you have entered the last character, press the

4.3 USING PRODUCT PROFILES

 button.

- The profile is saved.
- Display:

```
Store prod.prof.  
Storing...
```

- The product profile has now been saved.

4.3.4 Deleting a product profile

→ Call the MACHINE SETUP > Del. prod.profil function.

- The memory location that was active last is displayed.

→ Press the  or the  button until you retrieve the memory location you require (1–16).

→ Press the  button to delete the memory location:

- Display:

```
Del prod.profil  
Clearing...
```

- The product profile has now been deleted.

5.1 MAINTENANCE AND CLEANING

5.1.1 Replacing fuses



This section counts only for ALS 20X. The fuses at the ALS 256 cannot be replaced.



WARNING!

The machine operates using mains voltage! Touching live electrical parts may expose you to hazardous electrical currents and may lead to burns.

→ **Make sure that the machine is switched off and the power cable is unplugged before removing the fuse insert.**



CAUTION!

Risk of fire, if a wrong fuse type is inserted.

→ **Only replace fuses with the type and rating specified in this manual.**



The F1 and F2 fuses protect the primary side of the transformer. At any given time, only one of the two fuses is active. Which fuse is active depends on the switch setting of the voltage selector switch.

Active fuse	Mains voltage	Switch setting
F1	230 V	230
F2	110 V	115

[49] Relation between the switch setting of the voltage selector switch and the active fuse.

The CPU board and sensors are protected by a separate fuse in the switching power supply that must/may never be replaced.

If either of the two fuses is not working properly, only the drive motors are affected; the display and sensors continue to operate as normal.



Tool: Screwdriver

- Turn off the unit. Unplug the power cable.
- Rotate the fuse holder a few degrees anticlockwise.
 - The fuse holder pops up.
- Take the fuse out of the fuse holder.
- Replace defective fuse.
- Replace the fuse holder and rotate it clockwise, while applying light pressure, until the slot is vertically positioned.



Required fuse type:

- T5AH 250 V

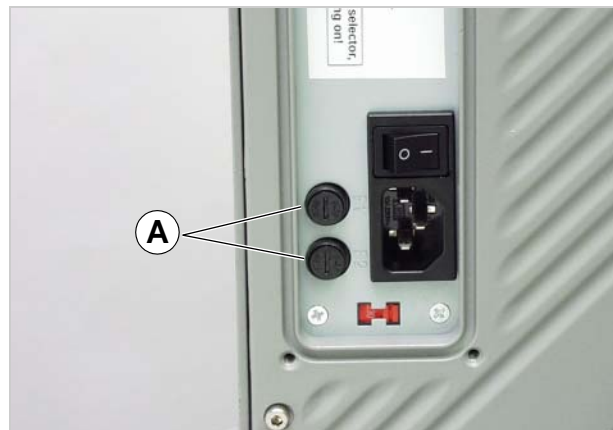

[50] Fuse holder (A) of the ALS 20x.

5.1 MAINTENANCE AND CLEANING

5.1.2 Cleaning agents



Cleaning agents for rubber rollers:

- Roller cleaner, order number 98925.
If other cleaning agents are used, there is a chance the rubber may corrode.

Cleaning agents for metal deflection rollers:

- Cleaning solvent, alcohol-based solvent, isopropyl alcohol, spray for removing labels

Cleaning the unit's housing:

- Commercially available neutral cleaning liquid



WARNING!

Cleaning solvent, alcohol-based solvent and isopropyl alcohol are highly inflammable!

- **Keep the cleaning agents, as well as any used cleaning cloths, away from open flames and other sources of ignition.**
- **Do not smoke.**
- **Observe the safety instructions on the container.**



CAUTION!

Unsuitable cleaning agents can cause considerable damage to the unit!

- **Do not use any cleaning agent that could damage or destroy the resin surface, labelling, display, nameplates, electrical components, etc. Observe the instructions of the cleaning agent manufacturer.**
- **Do not use any abrasive or plastic-corroding cleaning agents.**
- **Do not use any acidic or alkaline solutions.**

5.1 MAINTENANCE AND CLEANING

5.1.3 Regular maintenance

The label dispenser is designed to be maintenance-free. However, you should service the unit regularly in order to ensure reliable long-term operating results.

Depending on operating conditions, you should perform the following at least once a week:

- Carry out the cleaning and maintenance work described below.

Removing paper debris

- Wipe the paper residue from the rollers and edges.
- Clean the sensor lenses with a soft brush or cloth.

Renewal of the dust filter liner (ALS 256)

CAUTION!
An exhausted filter liner can cause the machine to overheat and to break down.

- Replace the filter liner regularly, at least in monthly intervals.

In case of overheating the machine, the error message „5026 MotorProtect CPU“ appears, see “List of error messages” on page 50.

- Screw out the four thumb screws [51A]. Remove the filter cover [51B].
- Replace filter liner (article no. A8697).
- Assemble the filter cover and fix it using the thumb screws.

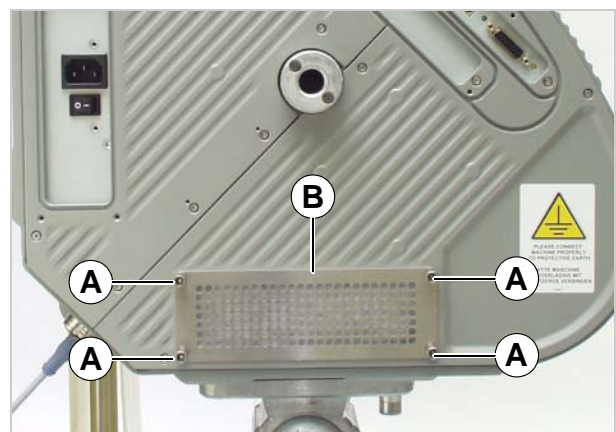

[51] Dust filter at an ALS 256.
A Thumb screws
B Filter cover

6.1 ERROR MESSAGES

6.1.1 Reporting errors

When an error occurs, the machine stops immediately and displays an error message on the control panel.

Error messages are displayed as follows:

Status num: 5144
Rewinder init20x 256

[52] An example of an error message:
5144 = status number; this number makes it easier to identify the message.
'Rewinder init' = status text; a brief description of the error.

Error messages that are not described here may only be resolved by a qualified service technician.

When an error occurs that is not described here:

- Press the button  to delete the message.
- Switch the device off, wait 30 seconds and then switch it on again.



If the error reoccurs:

- Request a service technician.









Error messages that are not mentioned here are described in the service manual.

6.1.2 List of error messages



Status	Status text	Cause	Action to take
5000	Bus device	<ul style="list-style-type: none"> – Device at I²C Bus cannot be contacted. – In most cases, this message appears as the first in a series of two or three messages which narrow down the error more precisely. 	<ul style="list-style-type: none"> → Delete the message by pressing the -key. → Switch the machine off, wait 30 seconds and switch it back on. → If the error message appears repeatedly, call in a servicing technician.
5001	No gap found	<ul style="list-style-type: none"> – The maximum limit for missing labels was exceeded (LABEL SETUP > Miss. label tol.). – The machine is not correctly set for the type of label (MACHINE SETUP > Light sens. type). – Label length is not correctly set (LABEL SETUP > Label distance). – Photoelectric label sensor is dirty. – Photoelectric label sensor is incorrectly positioned. – Photoelectric label sensor is not connected correctly. – Photoelectric label sensor is defective. – Rotary encoder is not adjusted correctly. 	<ul style="list-style-type: none"> → Check the points listed above and correct if necessary. → Press the  key to confirm the error message.
5002	Rewinder full	The (internal) roll diameter control has calculated that the end of the material roll has been reached.	→ Insert new label roll.

[53] List of error messages

6.1 ERROR MESSAGES

Status	Status text	Cause	Action to take
5026	MotorProtect CPU	<ul style="list-style-type: none"> – (ALS 256) Dust filter liner exhausted. This leads to overheating the machine. – (ALS 20X) Voltage selection switch set faulty. – There are some more possible causes, which require a qualified service technician to cure. 	<ul style="list-style-type: none"> → Renew the dust filter liner. → Check setting of the voltage selection switch. → If none of the above listed actions is successful, search for technical assistance.
5140	Rewinder control	<p>Rewinder control</p> <p> During problem-free operation, the rewind unit dancer arm only moves a minimal distance around the "control position". This is the position the dancer arm takes up after initialisation of the machine.</p> <ul style="list-style-type: none"> – Any force applied that moves the dancer arm from its control position. <p>Example: The feed motor is blocked; the backing paper is not conveyed quickly enough; as a result the dancer arm is pulled upwards.</p> <p>Example: The backing paper is torn; the dancer arm springs downwards.</p>	<ul style="list-style-type: none"> → Press the  key. – This reinitialises the dancer arm control; the dancer arm moves back into the control position.
5143	Rewinder Stop	<ul style="list-style-type: none"> – This message appears when the dancer arm was held against its upper stop for more than two seconds. <p>Effect: Power to the rewinder motor is switched off, so that the rewinder can be turned easily by hand.</p> <p> This effect is helpful when installing a new label roll, because the rewinder can be turned easily.</p>	<ul style="list-style-type: none"> → Press the  key to confirm the error message.
5145	Material feed	<p>The maximum permitted diameter (205 mm) for the rewinder roll has been reached.</p> <p> This error can only occur if the end of a new label roll was glued on to backing paper that had already been wound onto the rewinder.</p>	<ul style="list-style-type: none"> → Remove the rewound backing paper → Press the  key to confirm the error message.

6.1 ERROR MESSAGES

Status	Status text	Cause	Action to take
5147	Tandemsynch. Init	 This message can only appear during tandem operation. <ul style="list-style-type: none"> – Communication between the master and slave machines is not functioning. 	<ul style="list-style-type: none"> → Check tandem interface cable. <ul style="list-style-type: none"> – Is it a) in place and b) correctly connected? → Check the settings on both machines. <ul style="list-style-type: none"> – Siehe “Setting up tandem operation” auf Seite 112.
5200	Home position	 This message may appear when operating the applicator. The applicator did not reach its home position (upper end position) within the intended time-frame. <ul style="list-style-type: none"> – The applicator is stuck – Compressed air applicator: Compressed air supply interrupted or switched off – Cable not correctly connected. 	<ul style="list-style-type: none"> → Remove any obstructions → Check compressed air connection and reconnect correctly if necessary → Check cable and connect correctly if necessary.
5201	Touch Down	The applicator lower end position (Touch Down) was not reached in time.	
6002	New prog. vers.	New firmware has been loaded. This is a message from the labeller that new firmware is available.	<ul style="list-style-type: none"> → Press the Online button to confirm. <ul style="list-style-type: none"> – All parameters are reset to their factory settings.
6031	New Parameters	New firmware was loaded with the result that new functions have been added to the menu.	<ul style="list-style-type: none"> → No action necessary. The message is for information only.
6207	No file card	No compact flash card was found.	<ul style="list-style-type: none"> → Check whether a compact flash card is connected. If the compact flash card was not connected until after the machine was switched on: Switch the machine off and back on again.
9022	No network link	This status message can only appear when Ethernet address assignment is set to DHCP (INTERFACE PARA > NETWORK PARAM.> IP Addressassign). The cause is almost invariably an incorrectly plugged-in network connector.	<ul style="list-style-type: none"> → Check whether the network connector is plugged in correctly, correct if necessary.

[53] List of error messages

7.1 EU DECLARATION OF CONFORMITY

We,

Avery Dennison Deutschland GmbH
Ohmstrasse 3
85386 Eching, Germany

herewith assert that we have designed and built the device described in the following to conform with the basic safety and health requirements of the relevant EU directives.

Name of the devices:	ALS 204, ALS 206, ALS 256
Device type:	Label dispenser
Serial number:	Consists of a sequential number (five-digit) + date code (YYMM) + ending (device name): -ALS204, -ALS206 or -ALS256 (Example: 040060309-ALS204)
Relevant EU directives:	89/336/EEC (EMC Directive) 73/23/EEC (Low Voltage Directive)
Other applicable, harmonised norms, in particular:	EN 60 950-1: 2001 + A11 (Information technology equipment safety) EN 55 022:98 + A1:2000 + A2:03 (Information technology equipment - Radio disturbance characteristics - Limits and methods of measurement) EN 61 000-6-2: 2001 (Immunity standard for industrial environments) EN 61 000-3-2: 2000 (Limits for harmonic current emissions) EN 61 000-3-3: 1995 + A1:2001 (Limitation of voltage changes, voltage fluctuations and flicker)

Eching, 21 March 2006



Markus Roderer (General Manager)



051790

Avery Dennison Deutschland GmbH

Ohmstrasse 3
85386 Eching
Germany
Phone: +49-8165-925-0
<http://www.machines.averydennison.com>



Link information to your product