

SONY®

3-079-664-11(1)

Digital Still Camera

Bluetooth Function Operating Instructions

Before operating the unit, please read this manual thoroughly, and retain it for future reference.

Owner's Record

The model and serial numbers are located on the bottom. Record the serial number in the space provided below. Refer to these numbers whenever you call upon your Sony dealer regarding this product.

Model No. DSC-FX77

Serial No. _____

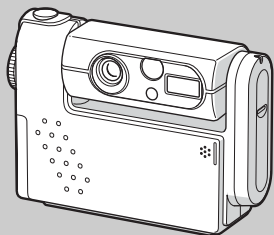

DSC-FX77

Cyber-shot
Digital Still Camera



MEMORY STICK™



InfoLITHIUM™



TYPE



Bluetooth™

Getting started _____

Sending images _____

Receiving images _____

Using your camera as the remote camera _____

Printing images _____

Authentication/Deleting the record _____

Additional information _____

Index _____

Introduction

This camera is designed to connect with a device equipped with the Bluetooth function, such as a digital still camera, a computer, or a printer. You can send/receive images without a cable. You can use your camera as a remote camera of your computer to perform remote shooting from the computer.

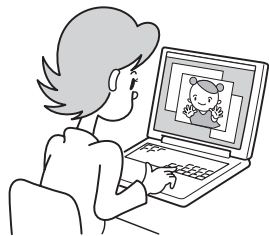

- Sending/receiving images with a Sony VAIO (pages 10, 13)
- Using your camera as a remote camera (page 14)



Printing images with a printer (page 16)

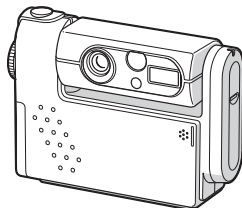

Sending/receiving images with another digital still camera (pages 8, 12)

To connect with your digital still camera, the Bluetooth device must be compatible with the “Image Push Feature” or the “Remote Camera Feature” of the “Basic Imaging Profile” (BIP). For details, see page 4.

Table of contents

Getting started

Introduction	2
The Bluetooth wireless technology	4
The “Basic Imaging Profile”	4
Bluetooth operation	4
Naming your camera	5

Sending images

Discovering devices (New search)	7
Sending images to a camera	8
On the single screen	8
On the Index (nine-image) screen	9
On the Index (triple-image) screen	10
Sending images to a Sony VAIO	10

Receiving images

Receiving images from a camera	12
Receiving images from a Sony VAIO	13
Preparing your camera	13
Preparing the VAIO	13

Using your camera as the remote camera

Using your camera as the remote camera of a Sony VAIO	14
Preparing your camera	14

Preparing the VAIO	15
--------------------------	----

Printing images

Printing images	16
Sending images to a printer	16

Authentication/Deleting the record

Authentication	17
Entering the passkey	17
Deleting the record	18

Additional information

File types that can be sent/received	19
Sending	19
Receiving	19
Troubleshooting	20
Warnings and messages	29
Menu items	31
SET UP items	32
Bluetooth specifications	33
The LCD screen	34

Index

Index	36
-------------	----

The Bluetooth wireless technology

The Bluetooth wireless technology allows communication between various Bluetooth devices without using cables. Devices which can use this technology include PCs, computer peripheral devices, PDAs, and mobile phones. This omnidirectional communication system enables communication even if the Bluetooth device is in a bag or if there are obstacles between the devices.

Also, the Bluetooth wireless technology has advanced security functions, such as scrambled frequencies and data encryption.

- When using the Bluetooth function, the distance between the camera and the device you intend to connect must be within 10 m (3.3 feet) without obstacles.
- When using the Bluetooth function, actual remaining time and time indicated with the battery remaining indicator may be different.

The “Basic Imaging Profile”

The “Basic Imaging Profile” (BIP) is the specification used when sending or receiving images between Bluetooth devices. The main features of the BIP enable sending or receiving images, use of the remote shutter feature of a digital still camera.

To connect with your camera, the Bluetooth device must be compatible with the “Image Push Feature” or the “Remote Camera Feature” of the “Basic Imaging Profile” (BIP).

Before using the Bluetooth device, check the BIP specifications of the device.

Bluetooth operation

Pressing the  Bluetooth button opens the Bluetooth menu. The  Bluetooth lamp turns blue during Bluetooth operations.

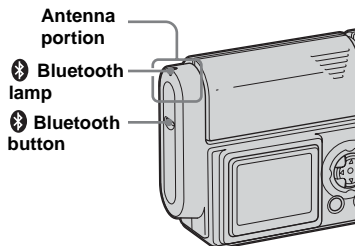

- Do not cover the antenna portion during a Bluetooth connection.
- Removing the battery pack during a Bluetooth connection may cause a malfunction.

Naming your camera

MODE dial: SET UP

You can name your camera with a name containing up to 24 characters. This name is used when the camera is searched for and discovered by other Bluetooth devices.

“SONY Cyber-shot” is the default name. We recommend you rename your camera with an easy-to-understand name.

Control button



MODE dial

MENU

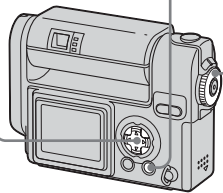

- Be sure to enter one or more characters when naming your camera.

1 Set the MODE dial to SET UP.

2 Select  (Bluetooth SETUP) with \blacktriangledown , select [CHANGE NAME] with \blacktriangleright , select [OK] with $\blacktriangle/\blacktriangleright$, then press \bullet .

The following screen appears.

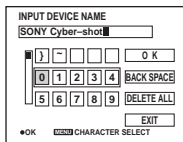

3 When renaming the camera for the first time, select [DELETE ALL] with $\blacktriangle/\blacktriangleright$, then press \bullet .

The default name is deleted.

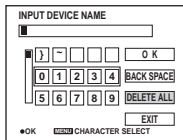

4 Select the desired character with $\blacktriangle/\blacktriangledown/\blacktriangleleft/\blacktriangleright$, then press \bullet .

The selected character is entered.

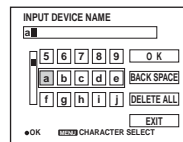

5 Repeat Step **4** as many times as needed to name the camera.

6 Select [OK] with $\blacktriangle/\blacktriangleright$, then press \bullet .

Renaming is completed and the  (Bluetooth SETUP) screen appears again. Confirm the name on the screen.

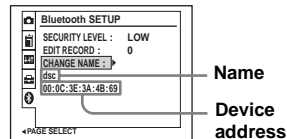

- Identify the camera with a name and device address so that it can be located during a device discovery.

To change the character type

Each time you press the MENU button, the character type changes as follows: number

→ lowercase letters → uppercase letters

→ symbols

To delete one character

Select [BACK SPACE], then press ●. The last character is deleted. Only the last character in a series can be deleted using [BACK SPACE].

To delete all the characters

Select [DELETE ALL], then press ●. All the characters are deleted.

To cancel the renaming operation

Select [EXIT], then press ●. The previous name is not changed.

Discovering devices

– New search

MODE dial: ►

You have to discover a Bluetooth device when the camera has not been connected to the device previously or when the camera does not have information on the device in the record for the connected device.

Before operation

Be sure to set the Bluetooth device to allow it to be connected.

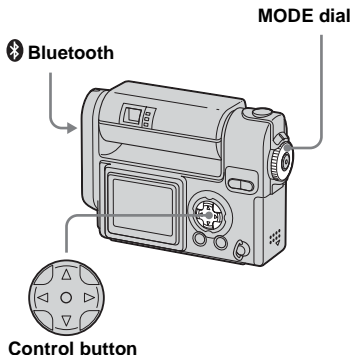

1 Set the MODE dial to ► and display the image you want to send.

2 Press Bluetooth.

The Bluetooth menu appears.

<Your camera>

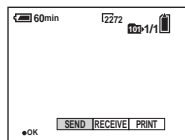

3 Select [SEND] with ◀, then press ●.

The Bluetooth function starts up and the SELECT THE RECEIVER screen appears.

<Your camera>



4 Select [NEW SEARCH] with ▼, then press ●.

“SEARCHING Bluetooth DEVICE” is indicated and the number of Bluetooth devices discovered is indicated.

<Your camera>



The device discovery operation is completed, the SELECT THE RECEIVER screen appears again.

<Your camera>

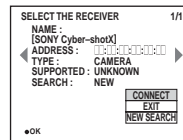

To cancel the new search

Select [STOP], then press ● in Step **4**. The devices discovered up to the point you stop the discovery operation are added to the SELECT THE RECEIVER screen.

- You may not be able to discover the desired device if the setting of the device is not discoverable. If you cannot discover the desired device by repeating a new search, check the setting of the device.
- The maximum number of devices that can be discoverable during a new search is 10 devices.
- The result of new search is displayed along with the record.

Sending images to a camera

MODE dial: 

You can send images to a camera equipped with the BIP-compatible Bluetooth function.

Before operation

Be sure to set the receiving camera to enable it to receive images (page 12).

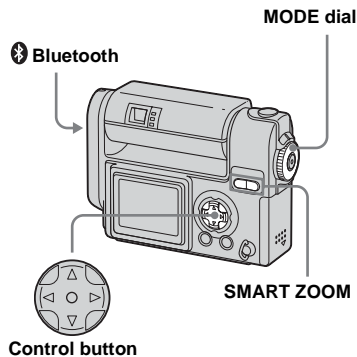

- This explanation is given using the DSC-FX77 model.
- For the image types you can send, see page 19.

On the single screen

1 Set the **MODE dial** to  and display the image you want to send.

2 Press  **Bluetooth**.

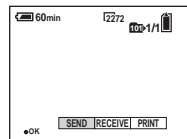

The Bluetooth menu appears.

<Sending camera>



3 Select **[SEND]** with , then press .

The Bluetooth function starts up and the **SELECT THE RECEIVER** screen appears.

4 Display the record of the receiving camera with /  or perform a new search (page 7).

5 Select **[CONNECT]** with , then press .

“SENDING” is indicated and the selected image is sent to the receiving camera.

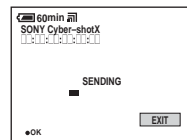

<Sending camera>

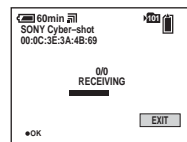

<Receiving camera>



- If passkey entry is required on the sending and receiving cameras, enter the passkey (page 17).
- If you run past the time limit for the passkey entry (30 seconds), connect again.

6 To send other images, display the desired image with , then press .

To cancel the sending operation

Sending camera

Select **[EXIT]**, then press  in Step **5** or **6**. The Bluetooth function is turned off and the Bluetooth menu appears again.

On the Index (nine-image) screen

1 Set the MODE dial to , then press the SMART ZOOM W button once to switch to the Index (nine-image) screen.

2 Press  Bluetooth.

The Bluetooth menu appears.

<Sending camera>



3 Select [SEND] with , then press .

4 Select [SELECT] with , then press .

5 Select the image you want to send with , , , or , then press .

A  mark is attached on the selected image.

<Sending camera>





At this time, the image has not been sent.



6 To send other images at the same time, repeat Step **5**.

• The maximum number of images you can send at a time is 54.

7 Press  Bluetooth.

8 Select [OK] with , then press .

The Bluetooth function starts up and the SELECT THE RECEIVER screen appears.

9 Display the record of the receiving camera with ,  or perform a new search (page 7).

10 Select [CONNECT] with , then press .

“SENDING” is indicated and the selected image is sent to the receiving camera.

<Sending camera>

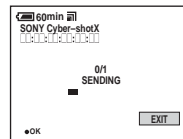

<Receiving camera>

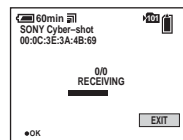

- If passkey entry is required on the sending and receiving cameras, enter the passkey (page 17).
- If you run past the time limit for the passkey entry (30 seconds), connect again.

When the images have been sent, “SENT” is indicated on the sending camera.

11 Select [EXIT], then press .

The Bluetooth function turns off and the Bluetooth menu appears again.

To cancel the sending operation
Sending camera

Select [EXIT], then press  in Step **10**. The Bluetooth function is turned off and the Bluetooth menu appears again.

On the Index (triple-image) screen

1 Set the MODE dial to , then press the SMART ZOOM W button twice to switch to the Index (triple-image) screen.



2 Move the image you want to send to the center with / .

3 Press  Bluetooth.



The Bluetooth menu appears.

<Sending camera>



4 Select [SEND] with , then press .

The Bluetooth function starts up and the SELECT THE RECEIVER screen appears.

5 Display the record of the receiving camera with /  or perform a new search (page 7).

6 Select [CONNECT] with , then press .

“SENDING” is indicated and the selected image is sent to the receiver camera.

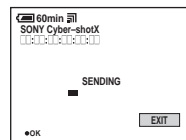

<Sending camera>

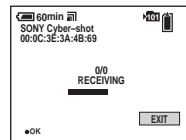

<Receiving camera>



- If passkey entry is required on the sending and receiving cameras, enter the passkey (page 17).
- If you run past the time limit for the passkey entry (30 seconds), connect again.

7 To send other images, move the desired image to the center with / , then press .

To cancel the sending operation
Sending Camera

Select [EXIT], then press  in Step **6** or **7**. The Bluetooth function is turned off and the Bluetooth menu appears again.

Sending images to a Sony VAIO

MODE dial: 

You can send images to a VAIO equipped with the BIP-compatible Bluetooth function.

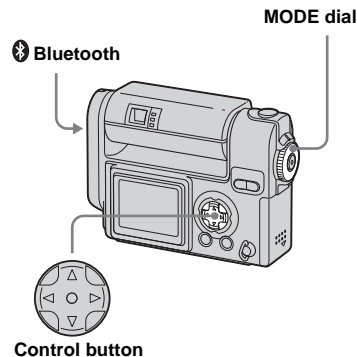

- For the latest information about connection using a VAIO, see the following URL: <http://www.sony-imaging.com/support/>
- You can also operate with the index (nine- or triple-image) screen.
- For the image types you can send, see page 19.

1 Turn on your VAIO and turn on the Bluetooth function.

2 Start up “BlueSpace.”

For details on this operation, refer to the HELP of the VAIO.

3 Set the MODE dial on the camera to  and display the image you want to send.

4 Press  Bluetooth on the camera.

The Bluetooth menu appears.

5 Select [SEND] with , then press .

The Bluetooth function starts up and the SELECT THE RECEIVER screen appears.

6 Display the record of the receiver with  or perform new search (page 7).

7 Select [CONNECT] with , then press .

“SENDING” is indicated on the camera and the selected image is sent to the VAIO.

<Sending camera>

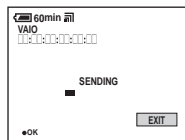

- If passkey entry is required on your camera and the VAIO, enter the passkey (page 17).
- If you run past the time limit for the passkey entry (30 seconds), connect again.

8 To send other images, display the desired image with , then press .

To cancel the sending operation Your camera

Select [EXIT], then press  in Step **7** or

8. The Bluetooth function is turned off and the Bluetooth menu appears again.

Receiving images from a camera

MODE dial:

You can receive images from a camera equipped with the BIP-compatible Bluetooth function.

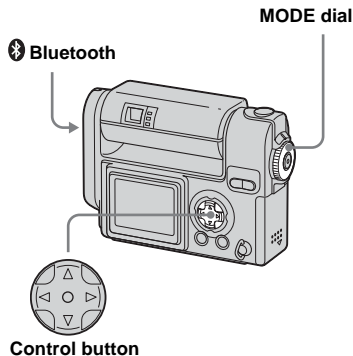

- You can also perform this operation with the index (nine- or triple-image) screen.
- For the image types you can receive, see page 19.

1 Set the MODE dial to

2 Press Bluetooth.

The Bluetooth menu appears.

<Receiving camera>

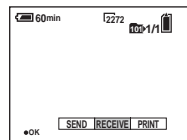

3 Select [RECEIVE] with , then press .

The Bluetooth function starts up and "WAITING FOR CONNECTION" is indicated. The camera is then connectable.

<Receiving camera>

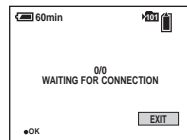

4 Discover the receiving camera with the sending camera, and send images.

"RECEIVING" is indicated and the image is sent to the receiving camera. After recording the image in the receiving camera, the receiving camera turns back to be receivable (WAITING TO RECEIVE).

<Receiving camera>

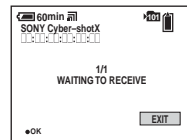

To cancel the receiving operation

When [EXIT] is indicated on the screen, you can cancel the receiving operation at any time. Select [EXIT], then press . The Bluetooth function is turned off and the Bluetooth menu appears again. The file currently being received is not saved.

When the sending camera turns off the Bluetooth function

The following screen appears.

<Receiving camera>

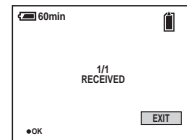

If you want to receive other images, select [EXIT] to turn off the Bluetooth function. Then, repeat Steps **3** and **4**.

Receiving images from a Sony VAIO

MODE dial:

You can receive images from a VAIO equipped with the BIP-compatible Bluetooth function.

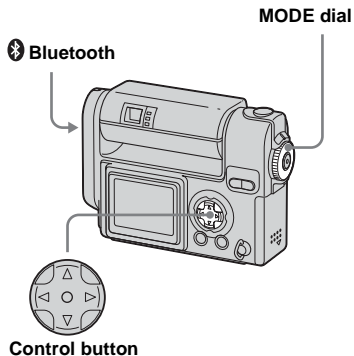

- For the latest information about connection using a VAIO, see the following URL: <http://www.sony-imaging.com/support/>
- For the image types you can receive, see page 19.

Preparing your camera

- 1 Set the MODE dial to .
- 2 Press  Bluetooth.

The Bluetooth menu appears.

<Your camera>

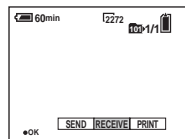

- 3 Select [RECEIVE] with / , then press .

The Bluetooth function starts up and "WAITING FOR CONNECTION" is indicated. The camera is then connectable.

<Your camera>

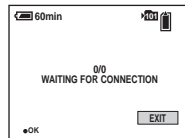

Preparing the VAIO

- 1 Turn on the VAIO and turn on the Bluetooth function.
- 2 Start up "BlueSpace."

For details on the following operations, refer to the HELP of the VAIO or URL: <http://www.sony-imaging.com/support/>

Using your camera as the remote camera of a Sony VAIO

MODE dial: / P/SCN

You can perform remote shooting from a VAIO equipped with the BIP-compatible Bluetooth function.

The maximum time you can use the camera as a remote camera is three hours. The camera automatically turns off after three hours.

Do not use the camera for hours as a surveillance camera and such. This may cause a malfunction.

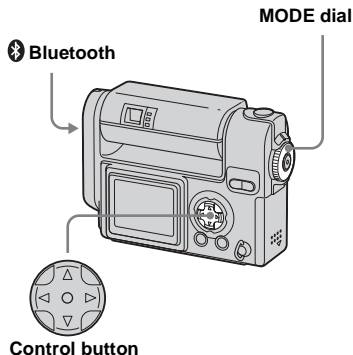

- For the latest information about connection using a VAIO, see the following URL: <http://www.sony-imaging.com/support/>
- When [SECURITY LEVEL] of your camera is set to [HIGH], passkey entry may be required (page 17).

Preparing your camera

1 Set the MODE dial on the camera to ,  P, or SCN.

2 Press  Bluetooth.

The Bluetooth menu appears.

<Your camera>

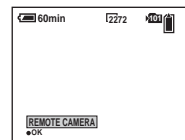

3 Press  to execute [REMOTE CAMERA].

The Bluetooth function starts up and "WAITING FOR CONNECTION" is indicated. The camera is then connectable.

<Your camera>

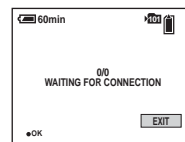

- When [MODE] (REC MODE) is set to [VOICE], you cannot select [REMOTE CAMERA].
- You cannot use the self-timer function.

Preparing the VAIO

1 Turn on the VAIO and turn on the Bluetooth function.

2 Start up “BlueSpace.”

For details on the following operations, refer to the HELP of the VAIO or URL: <http://www.sony-imaging.com/support/>

Printing images

MODE dial: ►

You can send images to a printer equipped with the BIP-compatible Bluetooth function and print images.

Before operation

Turn on the printer, and be sure to set the printer to allow it to be connected.

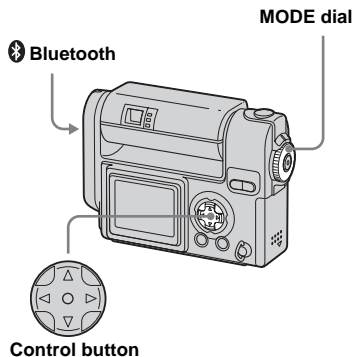

- You can also perform this operation with the index (nine- or triple-image) screen.
- For the image types you can send, see page 19.

Sending images to a printer

1 Set the **MODE** dial on the camera to ► and display the image you want to print.

2 Press **Bluetooth**.

The Bluetooth menu appears.

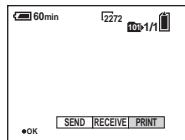

3 Select **[PRINT]**, then press ●.

The Bluetooth function starts up and the SELECT THE PRINTER screen appears.

4 Display the record of the printer with ◀/▶ or perform a new search (page 7).

5 Select **[CONNECT]** with ▲, then press ●.

"PRINTING" is indicated on the camera and the selected image is sent to the printer.

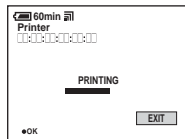

- If passkey entry is required, enter the same passkey as that of the printer (page 17).
- If you run past the time limit for the passkey entry (30 seconds), connect again.
- The printer may have a predetermined passkey or its passkey may have been set beforehand. For details on the passkey setting of the printer, refer to the operating instructions supplied with the printer.

6 To send other images, display the image you want to print with ◀/▶, then press ●.

- The number of images you can send in a row depends on the printer.

To cancel the sending operation

Select **[EXIT]**, then press ● in Step **5** or **6**. The Bluetooth function is turned off and the Bluetooth menu appears again.

- The camera cannot cancel the printing operation after the image has been sent to the printer. For details to stop the printing, refer to the operating instructions supplied with the printer.
- The edges of the image may not be printed depending on the printer setting.
- It may take a lot of time to print images, depending on the image size or the printer.

Authentication

What's a passkey

Passkey is used to authenticate two Bluetooth devices that have not previously connected to each other and create a trusted relationship between them.

You need to enter the same characters (passkey) to each device on passkey authentication process.

Once authentication of the device has been confirmed, the camera registered the device as a record. Since then you can connect the device without entering a passkey.

- **To ensure proper security, the passkey entry has a time limit (30 seconds), based on the Bluetooth standards.**
- The passkey entry may be required when the authentication valid period of the camera on other device is expired, the record is deleted, or the security setting is changed.
- Passkey entry may be required, depending on devices, each time you intend to connect.
- This "Passkey" is also referred to as a "Bluetooth passkey" etc. "PIN" is also used with the same meaning.

When the passkey entry screen appears on your camera before it appears on the other device

Enter the desired passkey on your camera. Then, enter the same passkey on the other device.

When the passkey entry screen appears on the other device before it appears on your camera

Enter the desired passkey on the other device. Then, enter the same passkey on your camera.

When the passkey entry screen appears on your camera and the other device at the same time

You can enter the passkey on either one. Enter the same passkey on your camera and the other device.

Entering the passkey

Enter the passkey when the passkey entry screen appears.

- 1 Select the desired character with ▲/▼/◀/▶, then press ●.**

The selected character is entered.

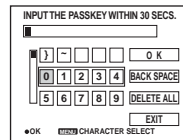

- 2 Repeat Step 1 as many times as needed to enter the desired passkey.**

- 3 Select [OK] with ▲/▶, then press ●.**

The passkey entry is completed.

- You can enter a passkey with up to 16 characters, however, you have to enter the passkey within the time limit (30 seconds). Due to the time limit, we recommend you use about a four-character passkey.
- The character types and the number of characters available depend on the device.

To change the character type

Each time you press the MENU button, the character type changes as follows: number → lowercase letters → uppercase letters → symbols

To delete one character

Select [BACK SPACE], then press ●. The last character is deleted. Only the last character in a series can be deleted using [BACK SPACE].

To delete all the characters

Select [DELETE ALL], then press ●. All the characters are deleted.

- If you select [EXIT], authentication is canceled and the connection is not established.

If you fail to enter the passkey

If you run past the time limit for the passkey entry (30 seconds) or enter a different passkey, confirm error messages then connect again.

Deleting the record

Your camera stores access history and information about the devices once connected as an item called the record. Since you can select a desired device from the record, you do not have to perform a new search each time you connect. The camera can store records on up to seven devices, and when you try to store another record on a device, the oldest item is automatically deleted from the list.

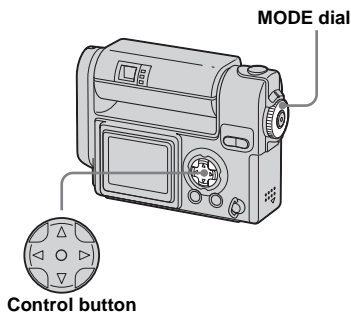

- 1** Set the MODE dial to SET UP.
- 2** Select  (Bluetooth SETUP) with ▼, [EDIT RECORD] with ▲/▼/▶, [OK] with ▲/▶, then press ●.

The SELECT RECORD screen appears.

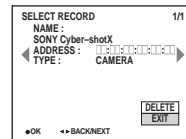

- 3** Display the record you want to delete with ◀/▶.
- 4** Select [DELETE] with ▲, then press ●.
- 5** Select [OK] with ▲, then press ●.
The selected record is deleted.
- 6** To delete other records, display the record you want to delete with ◀/▶, select [DELETE], then press ●.

To cancel the deletion

Select [CANCEL] in Step **5** or [EXIT] in Step **6**, then press ●.

File types that can be sent/received

Sending

The types of files you can send using your camera are as follows:

- Still image files shot normally.
 - In Multi Burst mode
- Still image files shot in
 - E-MAIL mode
 - VOICE mode.

- The files you can send using your camera are only JPEG files.
- The image may be resized or only the thumbnail file may be sent depending on the connected device.
- The settings for DPOF and protect are not valid in received images.
- File name and storage destination depend on the connected device.

Received image file storage destinations and file names on a VAIO

For details, refer to the HELP of the VAIO.

Receiving





- The only files you can receive using your camera are JPEG files.
- Received images are recorded in the recording folder. The file name format used is as follows:
“NETO□□□□.JPG”* and used it depends also on the setting of [FILE NUMBER] in  (SETUP 2).
* □□□□ stands for any number within the range from 0001 to 9999.
- The settings for DPOF and protect are not valid in received images.

Troubleshooting



If you have trouble with your camera, try the following solutions.

For details on your VAIO, refer to the **HELP** of the VAIO or the following URL: <http://www.sony-imaging.com/support/>



Sending/Printing images



Symptom	Cause	Solution
The Bluetooth button does not work.	<ul style="list-style-type: none">• The MODE dial is not set to .• The playback zoom function is being used.	<ul style="list-style-type: none">→ Set the MODE dial to  (see the operating instructions).→ Cancel the playback zoom function (see the operating instructions).
[SEND] or [PRINT] in the Bluetooth menu cannot be selected.	<ul style="list-style-type: none">• The MODE dial is not set to .• No “Memory Stick” is inserted.• No images are in the selected folder.• A movie or Clip Motion file is selected.	<ul style="list-style-type: none">→ Set the MODE dial to  (see the operating instructions).→ Insert a “Memory Stick” (see the operating instructions).→ Select the folder where the image is stored (see the operating instructions).→ Select an image file other than Movie or Clip Motion files.
The desired Bluetooth device cannot be discovered.	<ul style="list-style-type: none">• The device is not turned on.• The device is not connectable.• The device ran past the time limit.• The device is placed outside of radio wave range• The antenna portion of your camera or the device is covered with your hand etc.• The desired device is now connecting to another device.• The name of the device has been changed.• More than 10 Bluetooth devices are found around your camera.• The name of the device is not found.	<ul style="list-style-type: none">→ Turn on the device. For details, see the operating instructions supplied with the device.→ Check that the Bluetooth function of the device is started up and the device is connectable.→ Set the device so that it is connectable and perform a new search (page 7).→ Move the device closer to your camera.→ Do not cover the antenna portion (page 4).→ Wait until the connection is finished and perform a new search (page 7).→ Check the name of the device.→ The maximum number of devices discoverable using a new search is 10. The order in which devices are discovered depends on existing conditions. Turn off all devices except the desired device, or repeat new searches until the desired device is found.→ When a new search is canceled, the name of the device you are searching for may not be found. A substitute name (e.g., Device1) may be displayed instead. Identify the device address and type (page 35) and select it again or perform the new search again.



Symptom	Cause	Solution
You cannot connect to the desired device.	<ul style="list-style-type: none"> • The device is not turned on. • The device is not connectable. • The device ran past the time limit. • The device is placed outside of radio wave range. • The antenna portion of your camera or the device is covered with your hand etc. • The desired device is now connecting to another device. • Passkey authentication failed. • You did not enter the passkey on the device. • The device you intend to connect to is different. • The connection has been rejected. • Since passkey authentication has failed repeatedly, the connection may be rejected for a while. • The device is not BIP-compatible. 	<ul style="list-style-type: none"> → Turn on the device. For details, refer to the operating instructions supplied with the device. → Check that the Bluetooth function of the device is started up and the device is connectable. → Set the device so that it is connectable and perform a new search (page 7). → Move the device closer to your camera. → Do not cover the antenna portion (page 4). → Wait until the connection is finished and perform a new search (page 7). → Connect again and enter the same passkey both on your camera and the device (page 17). → Whether the passkey entry screen first appears on your camera or the device you intend to connect depends on the setting and the device. Connect again and enter the same passkey (page 17). → Check the name on the SELECT THE RECEIVER screen. → Set the device so that it is connectable. For details, refer to the operating instructions supplied with the device. → Try to connect again after a while. → The camera can connect to only a BIP-compatible device (page 4).
You cannot select the desired image.	<ul style="list-style-type: none"> • A movie or Clip Motion file has been selected. • No images in the selected folder. 	<ul style="list-style-type: none"> → Select an image other than Movie or Clip Motion file. → Select the folder where the image is stored (see the operating instructions).

Symptom	Cause	Solution
You cannot send an image to the desired device.	<ul style="list-style-type: none"> • The capacity of the media of the device (e.g., a “Memory Stick” or hard disk) is full. • The device disconnected the connection. • The device is placed outside of radio wave range. • The antenna portion of your camera or the device is covered with your hand etc. • The application of the device suddenly stops. • The MODE dial is not set to . • Your camera has been turned off by rotating the lens portion or for some other reason. • The number of jobs to be printed by the printer is over the limit. • There is no paper in the printer. • There is no ink in the printer. 	<ul style="list-style-type: none"> → Delete data from the media (e.g., a “Memory Stick” or hard disk) or replace it with a new one (see the operating instructions). → Check the status of the device and try to connect to the device again. For details on the device, refer to the operating instructions supplied with the device. → Move the device closer to your camera. → Do not cover the antenna portion (page 4). → Check the status of the device. For details on the device, refer to the operating instructions supplied with the device. → Set the MODE dial to  and connect again (pages 8, 10). → Turn on your camera and connect to the device again (pages 8, 10). → The number of images acceptable at one time depends on the printer. Wait until the printer is ready to accept images, then send images. For details, refer to the operating instructions supplied with the printer. → Supply the printer with paper. For details, refer to the operating instructions supplied with the printer. → Change the printer with ink. For details, refer to the operating instructions supplied with the printer.
DPOF or protect setting is not valid.	<ul style="list-style-type: none"> • The settings for DPOF or protect are not valid in the received images. 	—









Receiving





Symptom	Cause	Solution
The  Bluetooth button does not work.	<ul style="list-style-type: none"> • The MODE dial is not set to . • The playback zoom function is being used. 	<ul style="list-style-type: none"> → Set the MODE dial to  (see the operating instructions). → Cancel the playback zoom function (see the operating instructions).

Symptom	Cause	Solution
[RECEIVE] in the Bluetooth menu cannot be selected.	<ul style="list-style-type: none"> • The MODE dial is not set to . • No “Memory Stick” is inserted. • The write-protect switch on the “Memory Stick” is set to the LOCK position. • The capacity of the “Memory Stick” is insufficient. 	<ul style="list-style-type: none"> → Set the MODE dial to  (see the operating instructions). → Insert a “Memory Stick” (see the operating instructions). → Set the write-protect switch to the recording position (see the operating instructions). → Delete the images saved in the “Memory Stick,” or format it (see the operating instructions). → Replace the “Memory Stick” (see the operating instructions).
You cannot receive an image from the desired device.	<ul style="list-style-type: none"> • The sent file is not a JPEG file. • The capacity of the “Memory Stick” is insufficient. • The sent file is too large. • The device is placed outside of radio wave range. • The antenna portion of your camera or the device is covered with your hand etc. • The desired device is now connecting to another device. • Passkey authentication has failed. • The device you intend to connect to is different from the currently selected. 	<ul style="list-style-type: none"> → Send the JPEG file. → Delete the images saved in the “Memory Stick,” or format it (see the operating instructions). → Replace the “Memory Stick” (see the operating instructions). → Large size files may not be acceptable. → Move the device closer to your camera. → Do not cover the antenna portion (page 4). → Wait until the connection is finished and perform a new search (page 7). → Connect again and enter the same passkey both on your camera and the device (page 17). → Check the name on the SELECT THE RECEIVER screen.

Symptom	Cause	Solution
You cannot receive an image from the desired device (disconnected).	<ul style="list-style-type: none"> • The capacity of the “Memory Stick” is insufficient. • The device disconnected the connection. • The device is placed outside of radio wave range. • The antenna portion of your camera or the device is covered with your hand etc. • The device disconnected the Bluetooth connection. • The MODE dial is not set to . • The “Memory Stick” was removed. • The camera has been turned off by rotating the lens portion or for some other reason. 	<ul style="list-style-type: none"> → Delete images saved in the “Memory Stick,” or format it (see the operating instructions). → Replace the “Memory Stick” (see the operating instructions). → Check the status of the device and try to connect to the device again. For details on the device, refer to the operating instructions supplied with the device. → Move the device closer to your camera. → Do not cover the antenna portion (page 4). → Set the device so that it is connectable. For details, refer to the operating instructions supplied with the device. → Set the MODE dial to  and connect again (pages 12, 13). → Insert the Memory Stick” and connect again (pages 12, 13). → Turn on the camera and connect to the device again (pages 12, 13).
No request from the sending device.	<ul style="list-style-type: none"> • The device is now connecting to another device. • The camera ran past the time limit (about five minutes). 	<ul style="list-style-type: none"> → Make a connection with your camera. → Set the camera so that it is connectable again (pages 12, 13).
You cannot play back received images.	<ul style="list-style-type: none"> • Incompatible JPEG files or files shot using other cameras may not be properly played back on your camera. • The image is corrupted. 	—
Thumbnail files on the index screen are displaced in blue.	<ul style="list-style-type: none"> • The received file has no thumbnail. 	→ There are some cases that JPEG files received from a VAIO or other devices have no thumbnails. Such files are displayed in blue on the index screen. However, this does not affect the actual image received.
DPOF or protect settings are not valid.	<ul style="list-style-type: none"> • The settings for DPOF or protect are not valid in the received images. 	—
Black bands surround the image.	<ul style="list-style-type: none"> • The image size does not correspond to that of your camera. 	→ When the image size does not corresponds to that of your camera, black bands may appear around the image.

Remote camera

Symptom	Cause	Solution
The Bluetooth button does not work.	<ul style="list-style-type: none"> The MODE dial is not set to ,  P, or SCN. The camera is in quick review mode. 	<ul style="list-style-type: none"> → Set the MODE dial to ,  P, or SCN (see the operating instructions). → Exit the quick review mode (see the operating instructions).
[REMOTE CAMERA] in the Bluetooth menu cannot be selected.	<ul style="list-style-type: none"> The MODE dial is not set to ,  P, or SCN. No “Memory Stick” is inserted. The write-protect switch on the “Memory Stick” is set to the LOCK position. The capacity of the “Memory Stick” is insufficient. [MODE] (REC MODE) is set to [VOICE]. 	<ul style="list-style-type: none"> → Set the MODE dial to ,  P, or SCN (see the operating instructions). → Insert a “Memory Stick” (see the operating instructions). → Set the write-protect switch to the recording position (see the operating instructions). → Delete the images saved in the “Memory Stick,” or format it (see the operating instructions). → Replace the “Memory Stick” (see the operating instructions). → Set [MODE] (REC MODE) to a position other than [VOICE] (see the operating instructions).
No request from the desired device.	<ul style="list-style-type: none"> The device (controller) is now connecting to another device. You did not enter the passkey on the device. The device you intend to connect to is different from the one selected. The device is not a BIP-compatible. The device is placed outside of radio wave range. The antenna portion of your camera or the device is covered with your hand etc. The camera ran past the time limit (about five minutes). 	<ul style="list-style-type: none"> → Connect the controller to your camera. → Connect again and enter the correct passkey. → Check the name on the SELECT THE RECEIVER screen. → The camera can connect to only a BIP-compatible device (page 4). → Move the device closer to your camera. → Do not cover the antenna portion (page 4). → Set the camera so that it is connectable again (page 14).

Symptom	Cause	Solution
The connection is disconnected.	<ul style="list-style-type: none"> • The capacity of the “Memory Stick” is insufficient. • The MODE dial is not set to ,  P, or SCN. • The “Memory Stick” was removed. • The camera has been turned off by rotating the lens portion or for some other reason. • The device disconnected the connection. • The device is placed outside of radio wave range. • The antenna portion of your camera or the device is covered with your hand etc. • The device is disconnected the Bluetooth connection. • The camera ran past the time limit of the remote camera time limit (about three hours). 	<ul style="list-style-type: none"> → Delete images saved in the “Memory Stick,” or format it (see the operating instructions). → Replace the “Memory Stick” (see the operating instructions). → Set the MODE dial to ,  P, or SCN (see the operating instructions). → Insert the Memory Stick” and connect again (page 14). → Turn on the camera and connect to the device again (page 14). → Check the status of the device and connect to the device again. For details on the device, refer to the operating instructions supplied with the device. → Move the device closer to your camera. → Do not cover the antenna portion (page 4). → Set the device so that it is connectable. For details, refer to the operating instructions supplied with the device. → The maximum time you can use the camera as a remote camera is three hours. The camera automatically turns off after three hours.
The shutter clicks even if you set it not to click.	<ul style="list-style-type: none"> • The shutter always clicks during the remote camera mode. 	—
The buttons do not function.	<ul style="list-style-type: none"> • The buttons do not function during the remote camera mode except for SMART ZOOM, POWER, and the MODE dial . 	—
The self-timer is canceled.	<ul style="list-style-type: none"> • The self-timer cannot be used in the remote camera mode. 	—
You cannot perform remote shooting.	<ul style="list-style-type: none"> • The flash is being charged. • The capacity of the “Memory Stick” is insufficient. 	<ul style="list-style-type: none"> → Wait until the charging is finished and perform remote shooting (see the operating instructions). → Delete the images saved in the “Memory Stick,” or format it (see the operating instructions). → Replace the “Memory Stick” (see the operating instructions).

Entering a passkey

Symptom	Cause	Solution
The passkey entry is requested.	<ul style="list-style-type: none"> • The security level of the camera or the device has been changed. • The record has been deleted from the camera or the device to which you intend to connect. • The authentication valid period of your camera is expired on the device you intend to connect to. • The device you intend to connect to is different from the one selected. 	<ul style="list-style-type: none"> → When raising the security level, passkey entry may be required even if you have connected to the device before. Enter the passkey (page 17). → When deleting the record, the passkey entry may be required even if you have connected to the device before. Enter the passkey (page 17). → When the authentication valid period of your camera is expired, passkey entry may be required even if you have connected to the device. Enter the passkey (page 17). → Check the name on the SELECT THE RECEIVER screen.
The connection is disconnected from the desired device.	<ul style="list-style-type: none"> • You ran past authentication time limit (30 seconds). • The same passkey is not entered. • The device disconnected or ended the connection. • You did not enter the passkey on the other device. • The camera is turned off by rotating the lens portion or for some other reasons. 	<ul style="list-style-type: none"> → Enter the same passkey both in the camera and the device within 30 seconds (page 17). → Enter the same passkey both in the camera and the device within 30 seconds (page 17). → Set the device so that it is connectable. For details, refer to the operating instructions supplied with the device (page 17). → Whether the passkey entry screen first appears on the camera or the device depends on the setting and the device. Connect again and enter the passkey. → Turn on the camera and connect to the device again.
Authentication failed.	<ul style="list-style-type: none"> • You ran past the authentication time limit (30 seconds). • The same passkey was not entered. • The device disconnected or ended the connection. • The device you intend to connect to used a character not valid for the camera as a part of passkey. 	<ul style="list-style-type: none"> → Enter the same passkey both in the camera and the device within 30 seconds (page 17). → Enter the same passkey both in the camera and the device within 30 seconds (page 17). → Check the status of the device and try to connect to the device again. For details, refer to the operating instructions supplied with the device (page 17). → Enter only valid characters (page 17).

Others

Symptom	Cause	Solution
Data transmission speed is too slow.	<ul style="list-style-type: none"> The antenna portion of your camera or the connected device is covered with your hand etc. 	<ul style="list-style-type: none"> → Do not cover the antenna portion (page 4). → Data transmission speed depends on the distance between your camera and the device, obstacles, radio wave conditions, application software, or the OS. Change the position of your camera or set your camera closer to the device.
Since the distance between the camera and the desired device is within 10 m (3.3 feet), the connection cannot be established.	<ul style="list-style-type: none"> The antenna portion of your camera or the device is covered with your hand etc. <hr/> <ul style="list-style-type: none"> The desired device is now connecting to another device. The device is not connectable. 	<ul style="list-style-type: none"> → Do not cover the antenna portion (page 4). → Data transmission speed depends on the distance between the camera and the device, obstacles, radio wave conditions, application software, or the OS. Change the position of your camera or set your camera closer to the device. → When the device is connecting to another device, the device may not be displayed as an available device or be connectable at that time. → Set the device so that it is connectable. For details, refer to the operating instructions supplied with the device.

Warnings and messages

The following messages appear on the LCD screen.

Message	Meaning/ Corrective Action
FAIL TO CERTIFICATE INPUT THE SAME LETTERS INTO THE DEVICE TO BE CONNECTED AND THIS DEVICE WITHIN 30 SECS.	<ul style="list-style-type: none">You did not enter the passkey within 30 seconds. Enter it within 30 seconds (page 17).
NO REQUEST FROM THE SENDER	<ul style="list-style-type: none">If the camera does not receive any requests of connection or sending images from the device for five minutes, the connection is disconnected or the camera becomes non-connectable. Connect again.
NO REQUEST FROM THE CONTROL	
NO RESPONSE FROM THE RECEIVER	<ul style="list-style-type: none">If the camera does not receive any responses from a receiver/printer for 10 minutes, the connection is disconnected. Check the device status.
NO RESPONSE FROM THE PRINTER	
DISCONNECTED	<ul style="list-style-type: none">Since the device disconnected for some reason or the distance between the camera and the device is too great far, the connection was disconnected.
REFUSED TO CONNECT	<ul style="list-style-type: none">The connection was rejected by the device you intend to connect to by the setting or operations of that device. Change the setting of the device.
REFUSED BY THE RECEIVER	<ul style="list-style-type: none">The request to send an image, or the image itself was rejected.You are trying to send or print an incompatible image.
REFUSED BY THE PRINTER	
RECEIVER'S SERVICE IS NOT SUPPORTED	<ul style="list-style-type: none">The device is not compatible with BIP features (page 4).
PRINTER'S SERVICE IS NOT SUPPORTED	
NOT FOUND ENABLE THE RECEIVER	<ul style="list-style-type: none">The camera could not discover the desired device. Set the device to be connectable .
NOT FOUND ENABLE PRINTER TO RECEIVE	

Message	Meaning/ Corrective Action
FAIL TO CERTIFICATE INPUT THE SAME LETTERS INTO THE DEVICE TO BE CONNECTED AND THIS DEVICE	<ul style="list-style-type: none"> • The connection failed because a wrong passkey was entered. Enter the same passkey both on the camera and on the device you intend to connect to (page 17).
COMMUNICATIONS ERROR	<ul style="list-style-type: none"> • Communication error occurred. Connect again.
UNABLE TO CONNECT ENABLE THE RECEIVER	<ul style="list-style-type: none"> • The desired device cannot be discovered because the device is turned off, is too far away to be discovered, or other reasons.
UNABLE TO CONNECT ENABLE PRINTER TO RECEIVE	
NOT ENOUGH MEMORY	<ul style="list-style-type: none"> • The file size of the selected image is too large.
NOT ENOUGH MEMORY	
ENABLE THE RECEIVER	<ul style="list-style-type: none"> • The camera could not discover the desired device. Set the device to be connectable.
ENABLE PRINTER TO RECEIVE	
NO RECORD FOR CONNECTED DEVICE TRY A NEW SEARCH	<ul style="list-style-type: none"> • There is no record. Perform a new search (page 7).

Menu items

Menu items of the Bluetooth function to make changes depend on the position of the MODE dial. The LCD screen shows only the items you can use based on the current position of the MODE dial.

When the MODE dial is set to , P or SCN

Item	Description
REMOTE CAMERA	Uses the camera as a remote camera.

When the MODE dial is set to

Item	Description
SEND	Sends an image to a BIP-compatible Bluetooth device (page 8).
RECEIVE	Receives an image from a BIP-compatible Bluetooth device (page 12).
PRINT	Sends an image to a BIP-compatible Bluetooth printer to print the image (page 16).

When the MODE dial is set to  or SET UP, the Bluetooth menu is not displayed.

SET UP items

Set the MODE dial to SET UP. The SET UP screen appears.

Factory settings are indicated by ■.

(Bluetooth SETUP)

Item	Setting	Description
SECURITY LEVEL	HIGH / ■LOW	Sets the security level for a Bluetooth connection. When set to [HIGH], passkey entry is required for connecting to other devices for the first time (page 17).
EDIT RECORD	OK / CANCEL	Deletes the record (page 18).
CHANGE NAME	OK / CANCEL	Renames the camera (page 5).

- The device address (page 5) is unique for each device. You cannot change this address.

Bluetooth specifications

Communication type

Bluetooth standards, ver. 1.1

Maximum transmission speed¹⁾

About 723 Kbps

Output

Bluetooth standards, Power Class 2

Communication distance²⁾

About 10 m (3.3 feet) without
obstacles

Compatible Bluetooth profile³⁾

Basic Imaging Profile (Image Push
Initiator, Image Push Responder,
Remote Camera Responder)

Frequency band

2.4 GHz (2.400 to 2.4835 GHz)

- 1) Maximum data transmission speed based on Bluetooth standards, ver. 1.1.
This speed depends on the distance between the devices, obstacles, radio wave conditions, application software, or the OS.
- 2) This distance depends on the obstacles between the devices, radio wave conditions, application software, or the OS.
- 3) This specification is in accordance with the intended use between two Bluetooth devices.
This is defined by the Bluetooth standards.

The LCD screen

Sending/receiving/printing/ using as a remote camera

- 12 Playback folder indicator
- 13 Change folder indicator
- 14 Message area

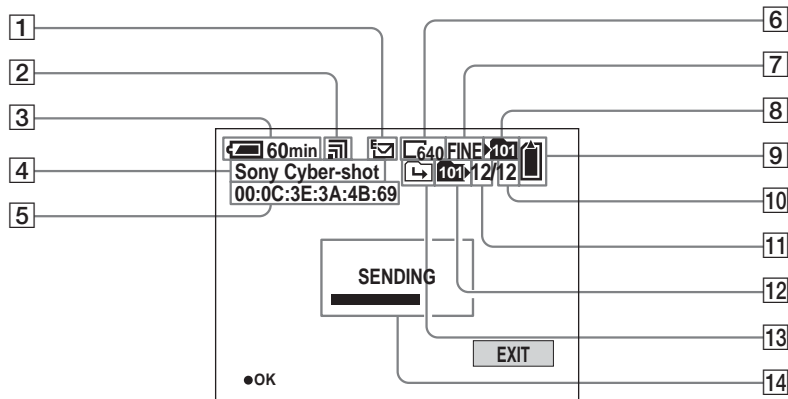

- 1 Recording mode indicator
- 2 Radio wave indicator
(Wi-Fi, NFC, Bluetooth) (Use this as a guide)
- 3 Battery remaining indicator
- 4 Device name of the connected device (5)
- 5 Device address of the connected device (5)
- 6 Image size indicator
- 7 Image quality indicator
- 8 Recording folder indicator
- 9 Remaining "Memory Stick" capacity indicator (4)
- 10 Number of images recorded in the playback folder
- 11 Image number
- 12 Playback folder indicator
- 13 Change folder indicator
- 14 Message area

Selecting the receiver/editing the record

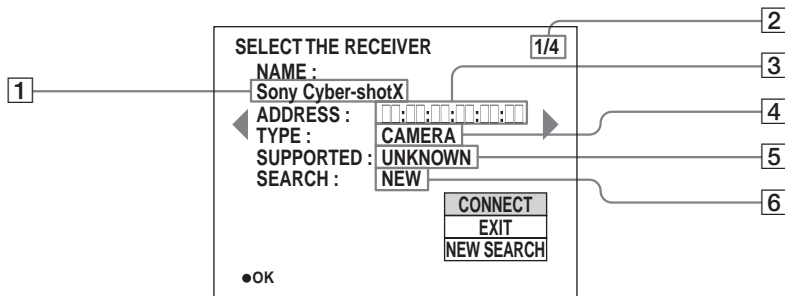

- 1 Device name** (5)
- 2 Record number/Total number of records**
- 3 Device address** (5)
- 4 Device type**
- 5 Supported service**
- 6 Search result** (7)

“UNKNOWN” is indicated when a device has not been connected.

After you perform a new search, “SEARCH” is added. A newly discovered device is indicated as “NEW.”

Index

A

Antenna portion 4

B

BIP

Image Push Feature 4

Remote Camera Feature 4

Bluetooth button 4

Bluetooth lamp 4

Bluetooth wireless technology 4

C

Changing the name 32

Communication distance 33

D

Device address 5

Device name 5

F

File

File name 19

Storage destination 19

Frequency band 33

I

Image Push Feature 4

J

JPEG 19

N

Naming your camera 5

New search 7

O

Output 33

P

Passkey

Passkey entry 17

Print 16

Time limit 17

R

Receive

Image file types 19

Receiving 12

Record 18

Remote camera 14

Remote Camera Feature 4

S

Search result 35

Security level 32

Send

Image file types 19

New search 7

Sending to a camera 8

Sending to a VAIO 10

T

Thumbnail image 19

Time limit

Passkey entry 17

Using as a remote camera 14

Type 35

W

Warning messages 29



Printed on 100% recycled paper
using VOC (Volatile Organic
Compound)-free vegetable oil
based ink.

<http://www.sony.net/>

Sony Corporation Printed in Japan

Additional information on this product and answers to frequent
asked questions can be found at our Customer Support Website.