



DONE TO PERFECTION.

INSTALLATION & OPERATIONAL MANUAL

VK SERIES GAS FRYERS With KleenScreen *PLUS*® Filtration Systems



1VK45C Shown

MODELS:

1VK45A	ML-136885
1VK45D	ML-136886
1VK45C	ML-136887
1VK65A	ML-136888
1VK65D	ML-136889
1VK65C	ML-136890
1VK85A	ML-136891
1VK85D	ML-136892
1VK85C	ML-136893
1VK45AF	ML-136894
1VK45DF	ML-136895
1VK45CF	ML-136896
1VK65AF	ML-136897
1VK65DF	ML-136898
1VK65CF	ML-136899
1VK85AF	ML-136900
1VK85DF	ML-136901
1VK85CF	ML-136902
2VK45AF	ML-136903
2VK45DF	ML-136904
2VK45CF	ML-136905
2VK65AF	ML-136906
2VK65DF	ML-136907
2VK65CF	ML-136908
2VK85AF	ML-136909
2VK85DF	ML-136910
2VK85CF	ML-136911
3VK45AF	ML-136912
3VK45DF	ML-136913
3VK45CF	ML-136914
3VK65AF	ML-136915
3VK65DF	ML-136916
3VK65CF	ML-136917
3VK85AF	ML-136918
3VK85DF	ML-136919
3VK85CF	ML-136920
4VK45AF	ML-136921
4VK45DF	ML-136922
4VK45CF	ML-136923

For additional information on Vulcan-Hart or to locate an authorized parts and service provider in your area, visit our website at www.vulcanequipment.com

VULCAN-HART
DIVISION OF ITW FOOD EQUIPMENT GROUP, LLC
WWW.VULCANEQUIPMENT.COM

3600 NORTH POINT BLVD.
BALTIMORE, MD 21222
F-32971 REV. F (December 2011)

IMPORTANT FOR YOUR SAFETY

THIS MANUAL HAS BEEN PREPARED FOR PERSONNEL QUALIFIED TO INSTALL GAS EQUIPMENT, WHO SHOULD PERFORM THE INITIAL FIELD START-UP AND ADJUSTMENTS OF THE EQUIPMENT COVERED BY THIS MANUAL.

POST IN A PROMINENT LOCATION THE INSTRUCTIONS TO BE FOLLOWED IN THE EVENT THE SMELL OF GAS IS DETECTED. THIS INFORMATION CAN BE OBTAINED FROM THE LOCAL GAS SUPPLIER.

IMPORTANT

IN THE EVENT A GAS ODOR IS DETECTED, SHUT DOWN UNITS AT THE MAIN SHUTOFF VALVE AND CONTACT THE LOCAL GAS COMPANY OR GAS SUPPLIER FOR SERVICE.

FOR YOUR SAFETY

DO NOT STORE OR USE GASOLINE OR OTHER FLAMMABLE VAPORS OR LIQUIDS IN THE VICINITY OF THIS OR ANY OTHER APPLIANCE.

WARNING

Improper installation, adjustment, alteration, service or maintenance can cause property damage, injury or death. Read the installation, operating and maintenance instructions thoroughly before installing or servicing this equipment.

TABLE OF CONTENTS

IMPORTANT FOR YOUR SAFETY.....	2
INTRODUCTION.....	4
GENERAL.....	4
ORDERING PARTS.....	4
FRYER CAPACITIES.....	4
UNPACKING.....	5
INSTALLATION.....	5
Clearances.....	5
Location	5
CODES AND STANDARDS.....	6
ASSEMBLY	6
FLUE CONNECTION.....	7
ELECTRICAL CONNECTION.....	7
GAS CONNECTION.....	8
Quick-Disconnect for Units on Casters.....	8
GAS PRESSURE.....	8
TEST GAS SUPPLY.....	8
FRYERS WITH CASTERS.....	8
LEVELING THE FRYER.....	9
OPERATION.....	10
OVER-TEMPERATURE SHUTDOWN.....	10
BEFORE FIRST USE.....	10
Cleaning.....	10
FILLING TANK WITH SHORTENING.....	10
BASIC FRYING INSTRUCTIONS.....	11
Fry Basket Guidelines.....	11
EXTENDED SHORTENING LIFE.....	12
TURNING ON THE FRYER	12
PROGRAMMING THE SOLID STATE KNOB (A) CONTROL.....	13
PROGRAMMING THE SOLID STATE (D) CONTROL.....	14
PROGRAMMING THE COMPUTER (C) CONTROL.....	15
TURNING OFF THE FRYER	16
EXTENDED SHUTDOWN.....	16
FILTERING THE OIL.....	16
DRAINING THE TANK.....	17
BOIL OUT PROCEDURE.....	17
CLEANING.....	18
Daily.....	18
KLEENSCREEN <i>PLUS</i> ® INSTALLATION & OPERATION MANUAL....	19
GENERAL	19
ASSEMBLY.....	19
REMOVE & REPLACE KLEENSCREEN <i>PLUS</i> ® FILTER ENVELOPE...	21
OPERATION.....	22
FILTERING PROCEDURE.....	22
FILTERING SOLID STATE KNOB (A) CONTROLS.....	23
FILTERING SOLID STATE (D) CONTROLS.....	24
FILTERING COMPUTER (C) CONTROLS.....	25
FILTERING TIP.....	26
REMOVING EXCESS DEBRIS FROM THE FILTER.....	26
FLUSH AND DISCARD.....	26
BOIL OUT BYPASS™.....	27
THERMAL OVERLOAD PROTECTION RESET BUTTON.....	27
MAINTENANCE.....	28
FLUE VENT INSPECTION.....	28
Service in the US and Canada.....	28
Alarms and Error Messages.....	28
TROUBLESHOOTING.....	29
Troubleshooting Chart.....	29

INTRODUCTION

GENERAL

Vulcan Fryers are produced with quality workmanship and material. Proper installation, usage and maintenance will result in years of satisfactory performance.

Before installing the fryer, thoroughly read this manual and carefully follow all instruction.

This manual is applicable to model listed on the cover page. Procedures in this manual will apply to all models unless specified. Pictures and illustrations can be of any model unless the picture or illustration needs to be model specific.

ORDERING PARTS

Customers may order parts directly from their local authorized service center. If not known, call Vulcan Customer Service at 800-814-2028.

To speed up your order, provide the model number, serial number, gas type, part needed, item part number (if known) and quantity needed.

UNPACKING

This fryer was carefully inspected before leaving the factory. Upon acceptance of the shipment, the transportation company assumes full responsibility for safe delivery.

Immediately after unpacking the fryer, check for possible shipping damage. If the fryer is damaged, save the packaging material and contact the carrier within 15 days of delivery.

Check that the following have been included:

- ◆ Crumb Rack(s)
- ◆ Basket Hanger(s)
- ◆ Tank Brush
- ◆ Adjustable Casters (4) two locking, two non-locking for freestanding fryers. Fryer Batteries with the KleenScreen *PLUS*® Filtration System have casters installed from the factory.
- ◆ Drain Pipe Extension for freestanding fryers only.
- ◆ Twin Fry Baskets (2) per fry tank
- ◆ Cleanout Rod
- ◆ Fryer Batteries with the KleenScreen *PLUS*® Filtration System
 - Filter Pan
 - Suction Tube
 - Screen Assembly
 - Complimentary Pack of Micro-Filtration Envelopes
 - High temperature discard hose
- ◆ Manual, Quick Start Guide(s), and Warranty – Keep in safe place for future reference.

INSTALLATION

Do not use the door or its handle to lift the fryer.

Before installing the fryer, verify that the type of gas (natural or propane) agrees with the specifications on the fryer data plate, which is located on the inside of the door panel. Make sure the fryer is configured for the proper elevation.

Record your fryer model, device, and serial numbers for future reference in the space provided below. This information can be found on the fryer data plate.

Fryer Model No: _____

Device: _____

Serial No: _____

Clearances

- ◆ Minimum clearance from combustible construction:
 - 6" (15 cm) from the sides of the fryer
 - 6" (15 cm) from the back of the fryer
 - The fryer may be installed on combustible floors
- ◆ Minimum clearance from noncombustible construction:
 - 0" from the sides of the fryer
 - 0" from the back of the fryer
- ◆ Between the fryer and any open-top flame units:
 - 16" (41 cm)
- ◆ Allow space for servicing and operation.

Location

- ◆ Install fryer in an area with sufficient air supply for gas combustion.
- ◆ Do not obstruct the flow of combustion and ventilation air.
- ◆ Provide adequate clearance for air openings into the combustion chamber.
- ◆ Do not permit fans to blow directly onto fryer.
- ◆ Keep the fryer area free and clear from combustibles.
- ◆ Avoid wall-type fans, which create cross-currents within a room. Avoid open windows next to sides or back.

CODES AND STANDARDS

The fryer must be installed in accordance with:

In the United States:

- ◆ State and local codes, or in the absence of local codes, with:
- ◆ National Fuel Gas Code, ANSI-Z223.1/NFPA #54 (latest edition). Copies may be obtained from The American Gas Association Accredited Standards Committee Z223, @ 400 N. Capital St. NW, Washington, DC 20001 or the Secretary Standards Council, NFPA, 1 Batterymarch Park Quincy, MA 02169-7471.
- ◆ NFPA Standard #96 Vapor Removal from Cooking Equipment, latest edition, available from the National Fire Protection Association, Batterymarch Park, Quincy, MA. 02169-7471.
- ◆ National Electrical Code, ANSI/NFPA-70 (latest edition). Copies may be obtained from The National Fire Protection Association, Batterymarch Park, Quincy, MA. 02169-7471.
- ◆ In the commonwealth of Massachusetts all gas appliances vented through a ventilation hood or exhaust system with a damper or with a power means of exhaust shall comply with 248 CMR.

In Canada:

- ◆ Local codes
- ◆ CAN/CSA-B149.1 Natural Gas and Propane Installation Code (latest edition), available from the Canadian Standards Association, 155 Queen Street, Suite 1300, Ottawa, Ontario Canada K1P 6L1.
- ◆ CSA C22.1 Canadian Electric Code (latest edition), available from the Canadian Standards Association, 155 Queen Street, Suite 1300, Ottawa, Ontario Canada K1P 6L1.

ASSEMBLY

The fryer must be restrained to prevent tipping and the splashing of hot liquid. The means of restraint may be the manner of installation, such as connection to a battery of appliances, installing the fryer in an alcove, or by separate means such as adequate ties.

FLUE CONNECTION

Make the flue connection as follows:

- ◆ Comply with *Vapor Removal from Cooking Equipment*, ANSI-NFPA Standard #96 (latest edition), available from the National Fire Protection Association, Batterymarch Park, Quincy, MA 02269.
- ◆ Locate the fryer under a hood with adequate connection to an exhaust duct. The hood must extend 6" (15 cm) beyond fryer on both sides.
- ◆ Clearance above the fryer should be adequate for combustion byproducts to be removed efficiently.
- ◆ An 18" (46 cm) minimum clearance should be maintained between the flue vent and the filters of the hood venting system.
- ◆ Never make flue connections directly to the fryer.
- ◆ Do not obstruct the flow of the gases from the appliance. Proper air balance should be maintained in the room.
- ◆ Ensure that your ventilation system does not cause a down draft at the fryer's flue opening. Down drafts will not allow the fryer to exhaust properly and will cause overheating which may cause permanent damage. Damage caused by down drafts will not be covered under equipment warranty. NEVER allow anything to obstruct the flue of combustibles or ventilation exiting from the fryer flue. DO NOT put anything on top of flue area.

ELECTRICAL CONNECTION

WARNING

Electrical Grounding Instructions:

This appliance is equipped with a three prong (grounding) plug for your protection against shock hazard and should be plugged directly into a properly grounded three-prong receptacle. Do not cut or remove the grounding prong from this plug. Fryer must be electrically grounded in accordance with local codes, or in the absence of local codes, with the National Electrical Code, ANSI/NFPA 70, or the Canadian Electrical Code, CSA C22.2, as applicable.

Electrical diagram located on inside of door.

GAS CONNECTION

NOTICE All gas supply connections and any pipe joint compound must be resistant to the action of propane gases.

The gas inlet is located on the lower rear of the fryer. Codes require that a gas shutoff valve be installed in the gas line ahead of the fryer.

The gas supply line must be at least the equivalent of ½" (12.7 mm) iron pipe for single units and 1-1/4" (31.75 mm) for batteries. If using the optional quick-disconnect flex hose, ¾" (19 mm) iron pipe for single units and 1-1/4" (31.75 cm) iron pipe for batteries.

Make sure the pipes are clean and free of obstructions, dirt, and piping compound. A battery requires one or two connections of appropriate size for the gas requirement.

▲ WARNING Prior to lighting, check all joints in the gas supply line for leaks. Use soap and water solution. Do not use an open flame.

After piping has been checked for leaks, fully purge gas pipes to remove air.

GAS PRESSURES (ALL MODELS):

The gas pressure should be set at .08" W.C. (Water Column) (0.02 kPa) for natural gas and .08" W.C. (.02 kPa) for propane gas. If incoming pressure exceeds ½ PSI (3.45 kPa), an additional pressure regulator must be installed.

TESTING THE GAS SUPPLY PIPING SYSTEM:

When test pressures exceed ½ PSI (3.45 kPa), the fryer and its individual shutoff valve must be disconnected from the gas supply piping system.

When test pressures are ½ PSI (3.45 kPa) or less, the fryer must be isolated from the gas supply piping system by closing its individual shutoff valve.

Fryers with Casters:

Separate instructions for installing casters are included with the casters:

- ◆ The installation shall be made with a connector that complies with the Standard for Connectors for Movable Gas Appliances, ANSI Z21.69, CAN/CGA-6.16, and a quick-disconnect device that complies with the Standard for Quick-Disconnect Devices for Use with Gas Fuel, ANSI z21.41.CSA 6.9 or Quick-Disconnect Devices for Use with Gas Fuel.

- ◆ When installing a quick disconnect you must also install a means for limiting the movement of the fryer. This device will prevent the gas line or quick disconnect from being strained. The restraining device should be attached to the cutout on the back panel. See illustration for location.

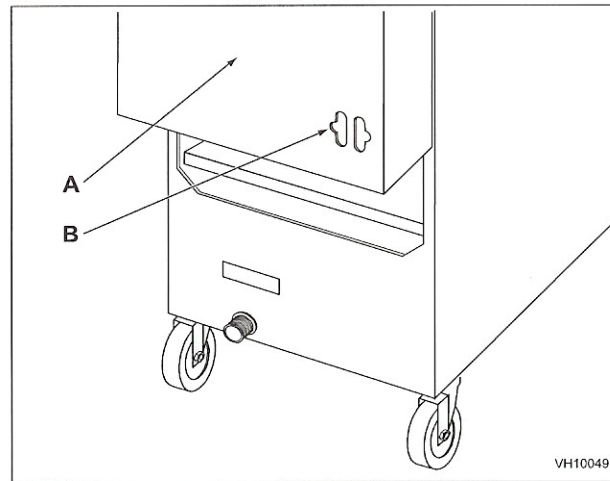

- A Rear of Fryer
- B Strain Relief Chain Connection
(Chain supplied by others)

- ◆ The fryer must be installed with a connector (not supplied by Vulcan) complying with the above codes.
- ◆ The fryer must be installed with restraining means to guard against transmission of strain to the connector. See illustration.
- ◆ The fryer must be installed with the casters provided.
- ◆ If the restraint is ever to be disconnected, first turn the gas supply off. If disconnection of the restraint is necessary, to reconnect this restraint after the fryer has been returned to its originally installed position.

LEVELING THE FRYER

Check the level of the fryer by placing a level on top of the fryer after gas connections have been made.

Ensure that the fryer is level front-to-back and side-to-side in the final installed position.

If using casters, lock the wheels after unit is level.

OPERATION

⚠ WARNING Hot oil and parts can cause burns. Use care when operating, cleaning and servicing the fryer.

⚠ WARNING Spilling hot frying compound can cause severe burns. Do not move fryer without draining all frying compound from the tank.

⚠ WARNING Fryer is not to be used during a power outage.

OVER-TEMPERATURE SHUTDOWN

If the shortening becomes overheated, a high-temperature shutoff device will turn the gas valve off.

If the fryer shuts down due to overheating, DO NOT power up the fryer until the shortening temperature is below 300°F (149°C).

If an overheating situation persists, contact your local Vulcan-Hart authorized service office.

BEFORE FIRST USE

Cleaning

New units are wiped down at the factory to remove any visible signs of dirt, oil, grease, etc. remaining from the manufacturing process.

Before any food preparation, thoroughly wash the protective oil from all surface parts and the tank interior with hot soapy water to remove any film residue and dust or debris.

NOTICE Do not use chlorine or sulfate/sulfide cleaners.

- ◆ Wash any accessories shipped with unit.
- Rinse fryer and accessories thoroughly and drain the fryer.
- ◆ Wipe tank completely dry with a soft, clean cloth.
- ◆ Close the drain valve.
- ◆ Fill the fryer tank with liquid shortening.
- ◆ Shortening level should be between the min and max lines in the fryer tank.
- ◆ Shortening will expand when heated. Do not fill the fryer tank past the MAX line.
- ◆ Add fresh shortening as needed to maintain oil level.

BASIC FRYING INSTRUCTION

- ◆ Set the desired temperature and allow shortening to heat up to that temperature.
- ◆ Fry items that are the same size to ensure equal doneness.
- ◆ Drain or wipe dry raw or wet foods to minimize splatter when lowering into hot shortening.
- ◆ Add fresh shortening as needed.

Fry Basket Guidelines

- ◆ Do not overfill baskets. (See table for recommended basket capacities below) Carefully lower basket into oil.
- ◆ When frying doughnuts and fritters, turn product only once during frying.
- ◆ When cooking French fries or onion rings, shake the basket several times.
- ◆ Batter covered foods should be dropped carefully, one by one, into shortening or basket. If you use the basket, first dip the basket into the shortening to reduce batter-build up on basket surfaces.
- ◆ When frying is completed, remove basket or product. Hang basket on rear hanger.

Fry Basket Capacity:

1VK45: Recommended pounds per basket are 2.5 lbs. (1.1 kg).

1VK65: Recommended pounds per basket are 3.0 lbs. (1.4 kg).

1VK85: Recommended pounds per basket are 3.5 lbs. (1.6 kg).

EXTENDING SHORTENING LIFE

Shortening life can be extended by the following guidelines:

- ◆ Do not salt foods over the fryer.
- ◆ Use good-quality shortening.
- ◆ Filter shortening daily (at a minimum).
- ◆ Replace shortening if it becomes poorly flavored.
- ◆ Keep equipment and surrounding clean. Use tank covers when not in use. (accessory).
- ◆ Set thermostat correctly.
- ◆ Remove excess moisture and particles from food products before placing on fryer.

TURNING ON THE FRYER

VKA solid state knob control:

- ◆ Open the door to the fryer. Turn the power switch to the on position.

Indicator Lights
(On/Start/Heating)

Temperature Knob Control

Power Switch

Start Button

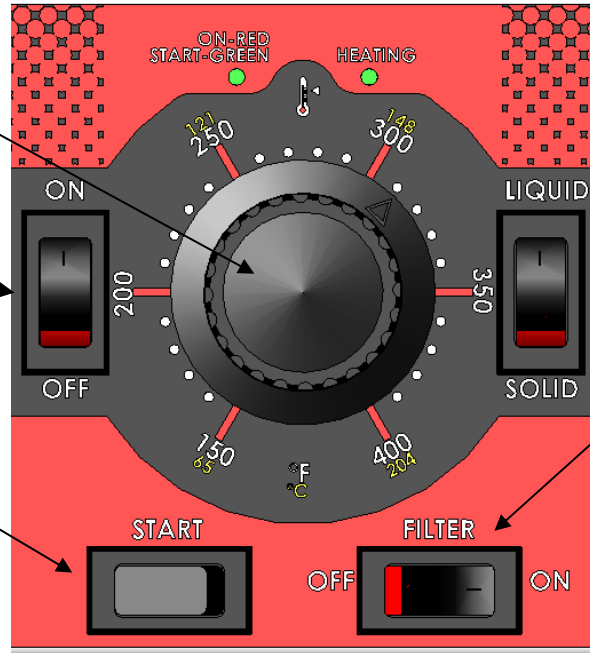

Melt Switch

Filter Switch

(For those models with KleenScreen
PLUS® Filter Systems)

- Open the door to the fryer. Select Liquid or Solid Shortening pressing the switch to the desired selection.
- Set temperature by turning the knob to the desired temperature.
- Press the power switch to the ON position. The burners will not light until the next step is completed.
- Press the START switch once for the burners to light. The START switch is a momentary switch and will reset after being pressed. The indicator light will change from Red to Green. Heating light will glow Yellow.
- The power burner will cycle on and off throughout the melt cycle. When the fry tank oil reaches 135° F the burners will stop cycling and remain on until the set temperature is reached. Once set temperature is reached the burners will cycle on and off to maintaining the set temperature.

VKD solid state digital and VKC programmable controls:

For solid state digital and programmable computer controls the power burner will light automatically. The power burner will cycle on and off throughout the melt cycle and continue afterwards maintaining the set temperature.

VULCAN FRYERS

SOLID STATE CONTROLS GUIDE



START UP in 4 Easy Steps

STEPS 1-4 TURNING ON THE FRYER



1 Fill fry tank with oil. Press the power switch **ON**. The red light will come on.



2 Set temperature knob to the desired set temperature.



3 Move the **MELT** switch to the correct shortening being used: Solid or Liquid.



4 Press the **START** switch and fryer will begin to heat. The burners or heating elements will cycle on and off through the melt cycle. When temperature reaches 135° F the burner or heating element will stay on until set temperature is reached. The red light will change to green. When the fryer calls for heat the yellow light will come on.

TURNING OFF THE FRYER



1 Open the door to the fryer. Press the power switch to the **OFF** position

SOLID STATE KNOB CONTROLS GUIDE

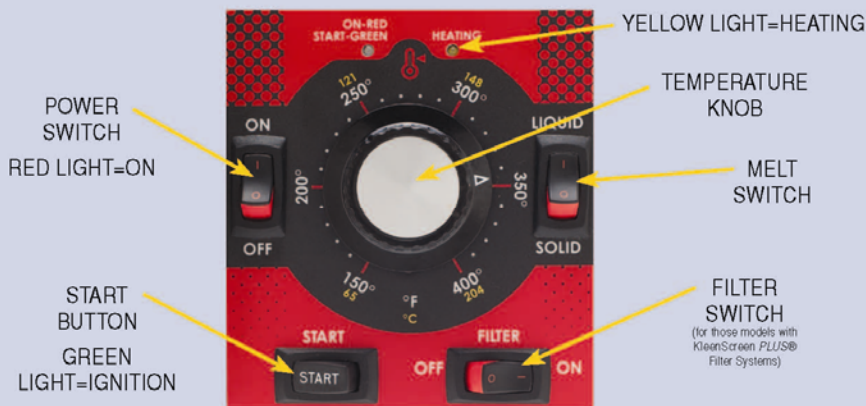

WARNING

⚠ HOT FRYING COMPOUND AND PARTS CAN CAUSE BURNS. USE CARE WHEN OPERATING, CLEANING, OR SERVICING THE FRYER. USE CARE WHEN FILTERING. DO NOT LEAVE UNATTENDED.

⚠ SPILLING HOT FRYING COMPOUND CAN CAUSE SEVERE BURNS. DO NOT MOVE THE FRYER WITHOUT FIRST DRAINING ALL FRYING COMPOUND FROM TANK.

[NOTICE] IF POWER IS MISTAKENLY TURNED OFF DURING THE FILTERING OPERATION, THE CORRECTIVE ACTION IS AS FOLLOWS:

1. CLOSE DRAIN VALVE
2. TURN POWER SWITCH ON
3. IMMEDIATELY OPEN DRAIN VALVE
4. CONTINUE FILTERING OPERATION PER STEPS 1-7 USING FILTERING GUIDE

Programming the Solid State Control





VULCAN FRYERS SOLID STATE CONTROLS GUIDE



PROGRAMMING in 8 Easy Steps (for revisions V4.00 or higher)

STEP 1

Fill fry tank with oil and then turn power on

Display will scroll through VULCAN > FRYERS > Rev. No. > MELT CYCLE LIQUID

STEP 2-8

PROGRAMMING MODES

To make changes to your program:

1. If display is locked it must be unlocked using the unlock code.
2. After unlocking go to steps 2 – 8



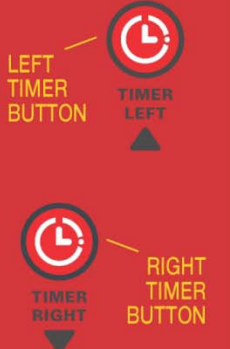

TO STOP A TIMER ONCE THE COUNTDOWN SEQUENCE HAS STARTED:

Press and hold the timer button until timer is reset and flashing light goes OFF.





2



Press  program button to enter the program mode: LEFT TIMER displays

Press  to increase time.

Press  to decrease time.

Press  to go to Step 3.

3



RIGHT TIMER displays

Press  to increase time.

Press  to decrease time.

Press  to go to Step 4.

4



COMPENSATING TIME

Press  to change to "N" OFF.

Press  to go to Step 5.

5



TEMPERATURE SETTING displays

Press  to increase temp.

Press  to decrease temp.

Press  to go to Step 6.

6



MELT CYCLE displays

Press  to change to "S" Solid.

Press  to change to NO MELT.

Press  to change to "L" Liquid.

Press  to go to Step 7.

7



UNLOCK displays

Press  to LOCK.

Press  to UNLOCK.

Press  to go to Step 8.

Note: VULCAN recommends keeping the controls LOCKED after programming to prevent altering

8



Press  button and HOLD FOR 3-5 seconds to save and exit program mode.

Note: Programming modes can be initiated while the fryer is ON by pressing the  button. If 'LOCKED' appears refer to 'UNLOCK' code.

OPTIONAL DISPLAY MODE

After the program mode is completed, the following screen will be displayed.

TEMPERATURE SETTING RESULTS

Results of programming for oil temperature is at set temperature



Display shows ACTUAL TEMPERATURE

OPTIONAL DISPLAY MODES

After the program mode is completed, one of the following screens will be displayed.

MELT CYCLE RESULTS

Results of programming MELT L



Display will say MELT L if oil temperature is below 135 degrees F

Results of programming MELT S



Display will say MELT S if oil temperature is below 135 degrees F

Results of programming NO MELT



VULCAN FRYERS

COMPUTER CONTROLS GUIDE



PROGRAMMING in 7 Easy Steps (for revisions V1.06 or higher)

START

Fill fry tank with oil and then turn power on.

Display will scroll through VULCAN FRYER ▶ Rev. No. ▶ MELT CYCLE LIQUID

STEP 1-7

PROGRAMMING MODES

UNLOCK CODE
 1. If display is locked it must be unlocked using the unlock code.

To UNLOCK this control, press buttons **1 2 3 4** while the word 'LOCKED' is displayed.

2. After unlocking go to steps **1 - 7**

1

Press program button **7** USER SETTINGS displays. To set cook temperature, press **1**. The current temperature will begin to flash. Type in the revised temperature. Press **7** to save your new cook temperature.

2

To set the melt cycle, press **2**. The LIQUID display will begin to flash. Press the **0** button to select, LIQUID, SOLID, and NO MELT options. Press **7** to save your melt cycle.

3

To set Cook Time manually, press **3**. SELECT MENU ITEM will display.

Select an item to be edited by pressing the corresponding number 1-10. The menu will change to allow edits to the menu item selected using the MENU ITEM SETTINGS in the right display.

3a

Press **1** to edit the NAME of the menu item and follow the directions on the right display. To change the letters press button **1** move towards the beginning of the alphabet and button **2** to move towards the end of the alphabet. The LED above the button selected for the menu item to be edited will be lit and the available parameters for editing will be listed in the right display. Press **7** to save the new NAME of the menu item.

3b

Press **2** to change the COOK TIME. The current time will flash. Type in the new COOK TIME. Press **7** to save your new COOK TIME.

3c

Press **3** to edit the SHAKE TIME. The current shake time will flash. Type in the new SHAKE TIME. Press **7** to save your new SHAKE TIME.

3d

Press **4** to change the HOLD TIME. The HOLD TIME will flash. Type in the new HOLD TIME. Press **7** to save your new HOLD TIME.

3e

Press **6** to choose COMPENSATING TIME or ACTUAL TIME. YES will begin to flash. Press the **0** button to select YES for COMP. TIME or NO for ACTUAL TIME. Press **7** to save your selection. Press **7** again to exit MENU ITEM SELECTION and return to SELECT MENU ITEMS.

4

Press the program button **7**. USER SETTINGS displays. To Lock control or keep the computer UNLOCKED press **1**. The current setting will flash and will sound. Press the **0** button to select YES or NO. Press **7** to save your selection.

5

To adjust the Beeper VOLUME, press **5**. The current setting will flash and will sound. Press the **0** button to select 1, 2 or 3. Press **7** to save your selection.

6

To set Language, press **6**. The current setting will flash. Press the **0** button to select ENGLISH, SPANISH, or FRENCH. Press **7** to save your selection.

7

To set the IDLE SETBACK, press **7**. The current time will flash. Type in the new IDLE TIME (10-99 minutes). Press **7** to save your new IDLE SETBACK time. Press **7** again to SAVE ALL OF YOUR SETTINGS and exit the programming mode. MENU ITEMS will display.

DISPLAY PANEL CONTROL GUIDE

TO REVIEW SETTINGS:

To REVIEW SETTINGS, press the OIL TEMP button. ACT temperature displays. Set temperature displays.

Hit **←** LEFT or **→** RIGHT arrow, followed by desired product key **1 - 0**. Display will scroll through settings for Time, Shake, Hold, and Cook Cycle.

OPERATION TIPS:

- To scroll through Menu Items 1-10 press the **0** button.
- To activate a cook cycle timer press a button **1 - 0**. First push the desired cook timer button and then press **1** or **0** corresponding to which basket is being used. Example: **2 1 0**. NOTE: You can use the same button for both **1** and **0** baskets. For example, **4 1 0**.
- To cancel a cook timer, press and release the **L** or **R** button and the corresponding number button **1 - 0**. The timer will stop and reset.
- With single basket lift fryers only press timer buttons **1 - 0** to activate the basket lift. There is no need to use the **L** and **R** buttons. To cancel the timer, press the same button again and the basket will raise up.
- Product keys blink when activated and are solid when programming.
- To silence alarm when timer is complete, press flashing menu item.
- VULCAN recommends keeping the controls LOCKED after programming to prevent altering.

OFFLINE PROGRAMMING WITH SOFTWARE MENU PROGRAM:

(Desktop or Laptop computer required. Menu Programming Software supplied with fryer).

To load a new product menu using the software menu program offline with a desktop or laptop computer:

1. Press **7** USER SETTING displays.
2. Select **3**. MENU ITEMS.
3. Insert USB memory drive with the new product menu files into USB Port.
4. Press **0** button to display available product menu files by saved name.
5. Press **1 - 0** to select the new product menu name.
6. Press arrows **←** **→** to confirm selection within 23 seconds while the menu selected is flashing.
7. Remove USB memory drive.

TURNING OFF THE FRYER

1. Press the power switch to the off position.

FILTERING THE OIL

⚠ WARNING Hot oil and hot parts can cause burns. Use care when operating, cleaning, and servicing the fryer.

Filter shortening at least once a day.

1. Do NOT turn off the power to the fryer. Leave power on.
2. Insert the drain extension into the drain valve. Tighten only hand tight.
3. Direct the drain extension into the mobile filtering device that you want to use.
4. A cold fryer will not drain easily. Always filter shortening between 250°F and 350°F. The shortening in the cold zone area will remain hard if the heat is only on for a few minutes. If necessary, use the clean-out rod to carefully move the hard shortening to an area above the cold zone where it will melt.
5. Slowly open the drain valve to allow oil to flow from the fry tank to the filter pan. Then open the drain valve all the way. Please note the gas power burner will automatically turn off at this point. DRAINING will appear on the digital display for solid state digital (D) and DRAINING OIL will display on computer models (C).
6. When fry tank is empty use the tank brush to remove any additional debris.
7. Close the drain valve. The display will change to; FILL TANK for solid state digital models (D) and FILL TANK for computer models (C).
8. Fill tank with new shortening. Fill to a minimum of the MIN level but no higher than halfway between MIN and MAX. Oil will expand as it is heated.
9. On solid state digital models (D) and computer models (C) models, the display will ask if the tank is full; TANK FULL, HIT TEMP. If the tank is full, press the Temp Button on the display. Once pressed, the gas power burner will ignite and begin heating the oil to desired temperature.
10. Press the START button for solid state knob control (A) and gas power burner will ignite and begin heating the oil.

DRAINING THE TANK

Free Standing Models:

1. Turn off fryer.
2. Insert the drain extension into the drain valve. Tighten only hand tight.
3. Direct the drain spout into the container that you want to drain the shortening into.
4. Open the drain valve. The oil will drain into the container. When the container is full or the fryer tank is empty, close the drain valve. Repeat this step until the fryer is empty. Remove the drain extension and place it back into the provided holder.
5. It is recommended to now boil out your fry tank. Follow the Boil Out procedure. Then perform the weekly clean-out as described under CLEANING.
6. Once tank is completely empty, boiled out and cleaned, add new shortening. Turn on the power switch to begin heating the oil to desired temperature.

BOIL OUT PROCEDURE

Weekly or when oil is replaced:

Free Standing Models:

1. Drain the tank as described under FILTERING THE OIL.
2. Close the drain valve and fill tank with water. Use a boil out solid degreaser low which can be ordered from your local dealer. Follow the instructions on the side of the package.

NOTICE Do not use chlorine or sulfate/sulfide cleaners.

3. Solution level must be between the MIN and MAX levels on the fryer tank.
4. Turn the power switch to the on position. With solid state knob controls (A), set the temperature knob to 200°F. Press the start button. Water boils at 212°F. For solid state digital models (D) and computer models (C) models, the temperature will automatically set for 195-200°F. Do not bring water temperature to an overly active boil.
5. Use the tank brush; clean the sides, bottom and heat exchanger tubes.
6. Place the drain extension in the drain valve and hand tighten only. Drain the cleaning solution from the tank into a container.
7. Close the drain valve and refill the tank with water. Add 1 cup (1/4 L) of vinegar to neutralize alkaline left by the cleaner. Solution level must be between the MIN and

MAX level on the fryer tank. Press the start button for (A) and Temp Button for (D) and C) models, to allow the solution to heat up. Allow solution to stand for a few minutes.

8. Drain the tank according to DRAINING THE TANK. Rinse thoroughly with clear, hot water. All traces of cleaner must be removed. Dry the tank thoroughly.
9. Close the drain valve and add shortening. Follow the FILLING TANK WITH SHORTENING procedure in this manual. The fryer is now ready for use. Press the start button for (A) and Temp Button for (D) and C) models, to allow the solution to heat up.

CLEANING

▲ WARNING Hot oil and hot parts can cause burns. Use care when operating, cleaning, and servicing the fryer.

Daily

Clean your fryer regularly with the tank brush along with a damp cloth, and polish with a soft dry cloth. If regular cleaning is neglected, grease will be burned on and discolorations may form.

Fingerprints are sometimes a problem on highly polished surfaces of stainless steel. They can be minimized by applying a cleaner that will leave a thin oily or waxy film.

- ◆ Clean all exterior surfaces of your fryer at least once daily.
- ◆ Use a damp cloth with warm water and a mild soap or detergent.

NOTICE Do not use chlorine or sulfate/sulfide cleaners.

- ◆ Rinse thoroughly, and then dry with a soft dry cloth.
- ◆ Keep the fryer exterior clean and free of accumulated grease to prevent stubborn stains from forming. If regular cleaning is neglected, grease will be burned on and discolorations may form.
- ◆ Remove discolorations by washing with any detergent or soap and water.
- ◆ Use a self-soaping, non-metallic scouring pad for particularly stubborn discolorations.
- ◆ Always rub with the grain of the stainless steel.
- ◆ Do not use a metallic scoring pad or harsh cleaners.

KleenScreen *Plus*® Filtration System Installation & Operational Manual for “VKAF”, VKDF” and “VKCF” Models

General

The KleenScreen *PLUS*® filtration system filters the oil as it is pumped back into its' respective tank(s). Only one tank can be drained and filtered at a time. Under no circumstances should both tanks be drained at the same time.

Assembly

- After unpacking, wash the filter pan, crumb basket and filter screen assembly. Make sure you remove the insert located inside the filter screen. Use dishwashing detergent and warm water, (parts are dishwasher safe). Rinse the filter pan, crumb basket and filter screen components completely and wipe all parts dry with a clean cloth.
- Pull out the filter drawer all the way leaving the filter pan opening exposed.
- Place the filter tank into the filter drawer making sure that the pins on the bottom of the filter pan line up with the holes in the filter drawer. Position the filter screen assembly into the suction tube clip in the filter pan positioning the filter screen assembly flat on the bottom of the filter pan. Place the primary crumb basket onto the left handle of the filter pan.
- Carefully line up the suction tube nozzle so that it mates with the oil receptacle block mounted on the frame of the fryer battery. Close the drawer. See Figures 1, 2 3 and 4

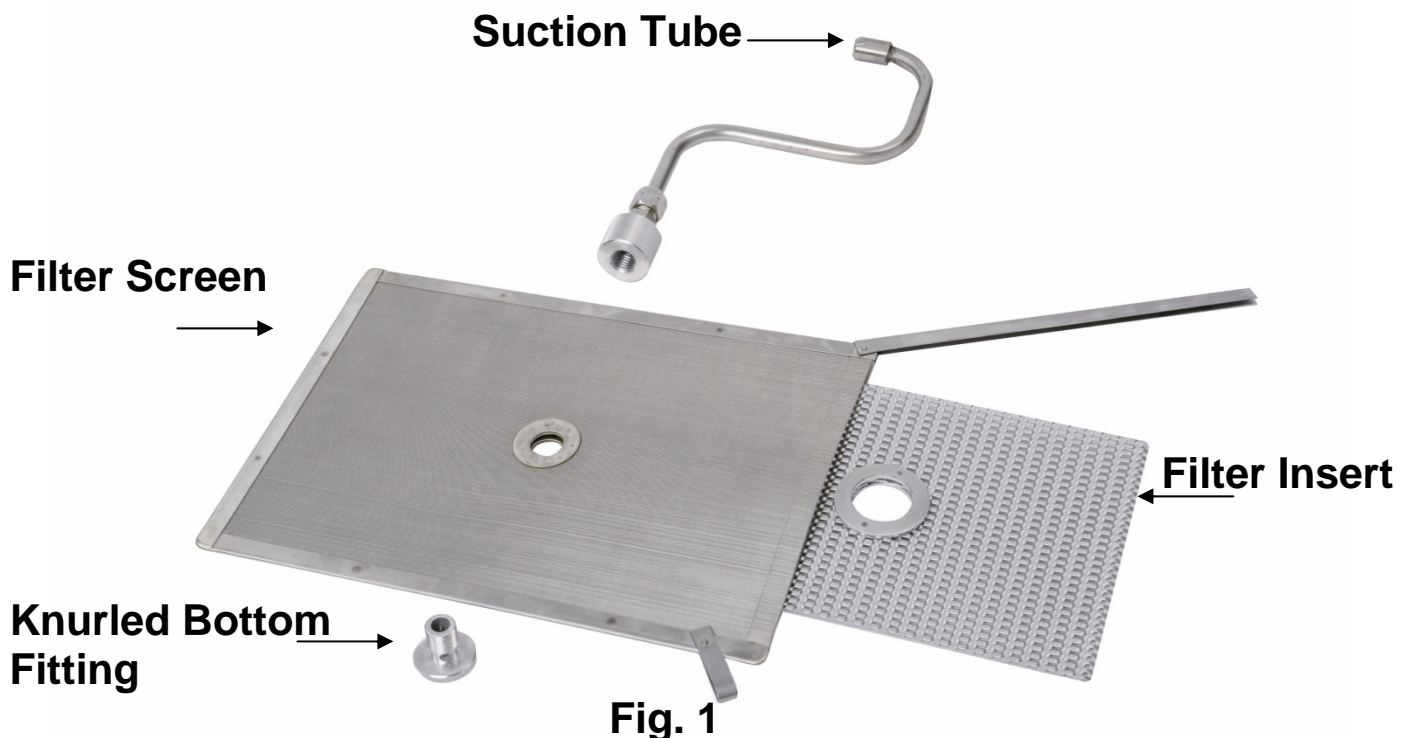

Fully assembled filter screen assembly:



Fig. 2

Secure Tube with Suction Tube Clip

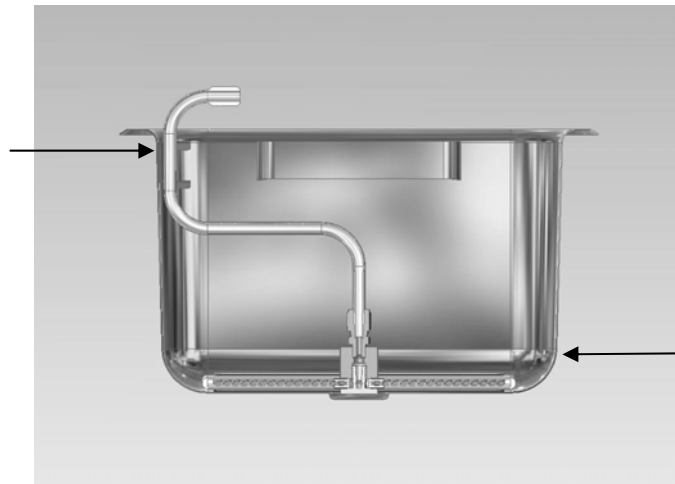

Filter Screen Lays Flat On Bottom of Filter Pan

Fig. 3

Micro-Filtration Fabric Envelope Assembly:

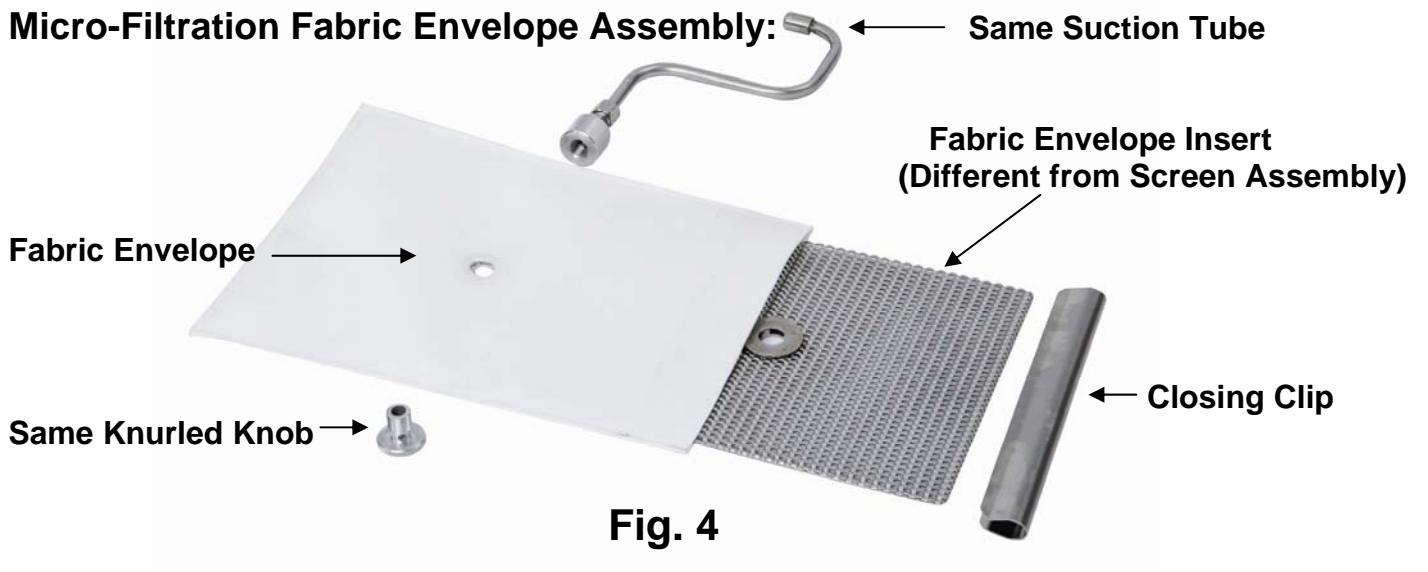

Fig. 4

INSTRUCTIONS TO REMOVE & REPLACE KLEENSCREEN *PLUS*® FILTER ENVELOPE

FOR ABSOLUTE FILTRATION & MAXIMUM FLOW RATE WE RECOMMEND YOU CHANGE YOUR FILTER ENVELOPES AT EVERY OIL CHANGE (10-14 DAYS DEPENDING ON OIL USAGE).



Step 1

Discard all oil from the filter vessel, (see pages 23 or 24). When the filter pan is empty, use a spatula and scrape off all debris left on the filter envelope and in the filter pan.



Step 2

Unscrew "S" Tube from filter by turning the Bottom Knurled fitting counter- clockwise.



Step 3

Remove SST Closure Clip by lifting off one side.



Step 4

Remove SST Filter Screen Insert and wash insert with hot water and dry thoroughly. The Filter Screen Insert is dishwasher safe. Place the insert into a new KleenScreen *PLUS*® Filter envelope.

DO NOT WASH FABRIC ENVELOPE



Step 5

Place Filter Screen Insert into the fabric envelope making sure that the holes line up. Fold over the other end of the envelope and place SST Closure Clip on – hinge over and firmly press clip all the way down to secure and seal filter assembly. Making sure that the folded end is face down; screw "S" Tube Assembly onto the Filter Assembly. Tighten the Bottom Knurled fitting. When tightened, the "S" Tube assembly should be perpendicular to the long side of the filter assembly.

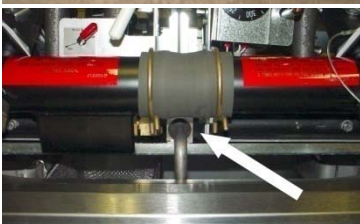

Step 6

Reposition the filter tube into the provided clip. Align filter tube so that the end of the "S" Tube engages the Oil Receptacle fitting each time the drawer is opened and closed.

Operation

▲ WARNING Hot oil and parts can cause burns. Use care when operating, cleaning and servicing the fryer.

▲ WARNING Spilling hot frying compound can cause severe burns. Do not move fryer without draining all frying compound from the tank.

NOTICE Never run water or boil out solution through filter and motor / pump. Doing so will void your fryer warranty.

FILTERING PROCEDURE

Oil Temperature should be 300-350° F. Use the provided crumb scoop to remove and suspend crumbs on the bottom of the tank before proceeding to Step 1.

1. Do not turn off the Fryer. The power must be on throughout the entire filtering process.

NOTICE Do **NOT** heat the fryer during the filtering procedure. Permanent damage to your fry tank may occur and warranty may be voided.

2. Vulcan recommends adding an oil treatment media to the oil prior to filtering.
3. Make sure that the filter drawer is closed completely and that the suction tube and receptacle block are in the correct position. Fig. 5

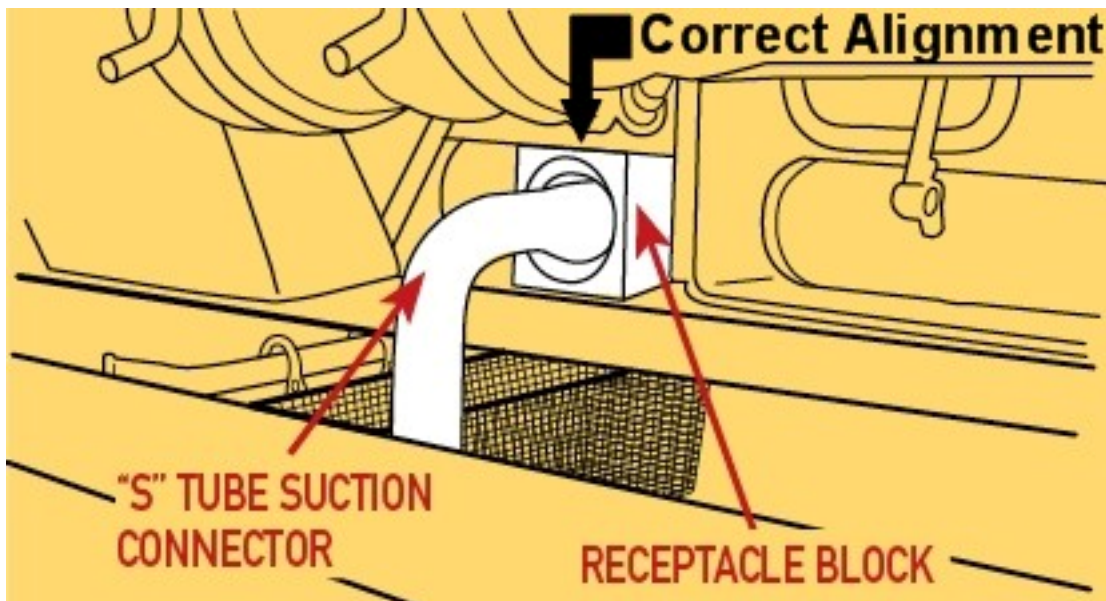

Fig. 5

VULCAN FRYERS

SOLID STATE KNOB CONTROLS GUIDE



FILTERING in 7 Easy Steps

STEPS 1-4

TIP: Use provided crumb scoop to remove and suspend crumbs on the bottom of tank before proceeding to Step 1.



1 Make sure that the Power is on. Do NOT turn off the power to the fryer.

- Vulcan recommends adding an oil treatment media to the oil prior to filtering.
- Make sure that the filter drawer is closed completely and that the suction tube and receptacle block are in the correct position.

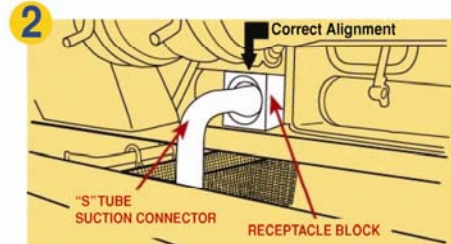

2 Open the fryer doors and ensure that the filter drawer is pushed back into place under the fryer with the "S" Tube Suction Connector and Receptacle Block engaged.



3 Open the drain valve slowly allowing the oil to drain down into the filter pan. The burners or heating elements will automatically turn off.

TIP: Use the provided tank brush to clean and remove food particles from the fry tank.



4 Press **FILTER** switch to engage the motor/pump. Allow the oil to cycle for a few minutes until the oil and fryer are clean.

STEPS 5-7



5 Close the drain valve slowly allowing the oil to fill the fry tank with clean oil. The burners or heating elements will not turn on at this point. Allow the oil to fill back into the fry tank from the filter pan. It is normal to see a few air bubbles during this process.



6 When the filter pan is empty push the **FILTER** switch to turn off the motor / pump. Oil level should be between the MIN and MAX lines.



7 Once the level of the oil has been checked and verified, press the **START** switch. The red light will turn to green. The burners or heating elements will automatically turn back on and the fryer will resume heating. Yellow light will display when heating.

DRAINING AND DISCARDING OIL FROM THE FRYER

- Follow filtering instructions steps **2-3**, however DO NOT put oil treatment media into fryer. Drain the fryer oil into the filter pan.
- Attach the quick disconnect hose to the discard male quick disconnect fitting. Do not connect hose while motor/pump is running.
- Place other end of the discard hose into a container that is large enough to retain the discarded shortening.
- To start the discard operation, filter switch behind door must be in the "use hose to discard only" position.
- Before pressing the **FILTER** button located behind the door, hold the hose firmly and point to the discard container. Press the **FILTER** button and the motor/pump will start immediately. Oil will begin to flow through the hose into the container.
- To turn off the motor/pump, simply push the **FILTER** button on the control again. Push the filter switch behind the door back to the "use hose to rinse & fill" position. Disconnect the discard hose. Be careful to let the hose drain before putting away. Close the drain valve and refill the fry tank with new oil.

NOTICE If discard vessel is not large enough to hold the entire shortening amount, stop the flow by pushing the **FILTER** button to turn the motor/pump off. Empty the container and resume discard operation by pushing the **FILTER** button and holding it for approximately 3 seconds.

NOTICE Open the filtering drawer approximately 1" to allow any oil in the return line to run back into the filter pan. This will take about 30 seconds to complete. Then open the drawer completely to clean filter components.
THESE INSTRUCTIONS ARE FOR FRYERS WITHOUT REAR OIL RECLAMATION CONNECTIONS.

WARNING

HOT FRYING COMPOUND AND PARTS CAN CAUSE BURNS. USE CARE WHEN OPERATING, CLEANING, OR SERVICING THE FRYER. USE CARE WHEN FILTERING. DO NOT LEAVE UNATTENDED.

SPILLING HOT FRYING COMPOUND CAN CAUSE SEVERE BURNS. DO NOT MOVE THE FRYER WITHOUT FIRST DRAINING ALL FRYING COMPOUND FROM TANK.

NOTICE IF POWER IS MISTAKENLY TURNED OFF DURING THE FILTERING OPERATION, THE CORRECTIVE ACTION IS AS FOLLOWS:

- CLOSE DRAIN VALVE
- TURN POWER SWITCH ON
- IMMEDIATELY OPEN DRAIN VALVE**
- CONTINUE FILTERING OPERATION PER STEPS 1-7

NOTICE NOT RECOMMENDED TO BE USED WITH SOLID SHORTENING.

Filtering Instructions for Solid State Controls

VULCAN FRYERS

SOLID STATE CONTROLS GUIDE



FILTERING in 7 Easy Steps (for revisions V4.00 or higher)

STEPS 1-3

TIP: Use provided crumb scoop to remove and suspend crumbs on the bottom of tank before proceeding to Step 1.

1 Make sure that the Power Switch is in the "ON" position. Fryer must have power to operate the motor/pump. Fryer Temperature should be between 300-350 Degrees Fahrenheit. **RECOMMENDED: ADD OIL TREATMENT MEDIA.**

2 Open the fryer doors and ensure that the filter drawer is pushed back into place under the fryer with the "S" Tube Suction Connector and Receptacle Block engaged.

3

- Turn the drain valve to allow the oil to drain into the filter pan below. The burners will automatically turn off.
- While draining the tank, use the provided tank brush to move the residue at the bottom and sides of the tank down into drain tube.
- To turn on the filter motor/pump, push the FILTER button located on the control panel, holding it for approximately 3 seconds.
- Allow the oil to cycle through the filtering operation for about 3 minutes or until satisfied that the oil and fry tank are clean. **DRAINING displays.**

TIP: Use provided tank brush to clean and remove food particles on the fry tank.

STEPS 4-7

4 When filtering is finished, close the red drain valve by turning the red drain handle. **FILL VAT displays.**

5 Allow all of the oil to flow back into the fryer from the filter pan. It is normal to see air bubbles in the tank towards the end of filtering. When the filter pan is empty, push the FILTER button to turn off the motor/pump. Oil level should be between the Min/Max lines on the tank back. **VAT FULL displays. (Display is asking if the tank is full).**

6 Once the oil level has been checked and verified, press the TEMP button. The burners will automatically turn back on and the fryer will resume heating. **HIT TEMP displays.**

7 After pressing the TEMP button the fryer resumes heating. **HEATING displays.**

DRAINING AND DISCARDING OIL FROM THE FRYER

A Follow filtering instructions steps **2 - 4**, however **DO NOT** put oil treatment media into fryer. Drain the fryer oil into the filter pan.

B Attach the quick disconnect hose to the discard male quick disconnect fitting. Do not connect hose while motor/pump is running.

C Place other end of the discard hose into a container that is large enough to retain the discarded shortening.

D To start the discard operation, filter switch behind door must be in the "use hose to discard only" position.

YOU MUST USE THE FILTER BUTTON ON THE DIGITAL CONTROL TO DISCARD THE OIL. Press the FILTER button on the digital control and hold for approximately 3 seconds to activate the motor/pump. Oil will begin to flow through the hose and into the container. **PLEASE NOTE** that the display will not change for this operation.

E To turn off the motor/pump, simply push the FILTER button on the digital control again. Push the filter switch behind door back to the "use hose to rinse & fill" position. Disconnect the discard hose. Be careful to let the hose drain before putting away. Close the drain valve and refill the fry tank with new oil.

WARNING: Hose connection will be HOT. Use protective heat resistant gloves when handling.

NOTE: If discard vessel is not large enough to hold the entire shortening amount, stop the flow by pushing the FILTER button to turn the motor/pump off. Empty the container and resume discard operation by pushing the FILTER button and holding it for approximately 3 seconds. **THESE INSTRUCTIONS ARE FOR FRYERS WITHOUT REAR OIL RECLAMATION CONNECTIONS.**

NOTICE: Open the filtering drawer approximately 1" to allow any oil in the return line to run back into the filter pan. This will take about 30 seconds to complete. Then open the drawer completely to clean filter components. **THESE INSTRUCTIONS ARE FOR FRYERS WITHOUT REAR OIL RECLAMATION CONNECTIONS.**

WARNING

- HOT FRYING COMPOUND AND PARTS CAN CAUSE BURNS. USE CARE WHEN OPERATING, CLEANING, OR SERVICING THE FRYER. USE CARE WHEN FILTERING. DO NOT LEAVE UNATTENDED.
- SPILLING HOT FRYING COMPOUND CAN CAUSE SEVERE BURNS. DO NOT MOVE THE FRYER WITHOUT FIRST DRAINING ALL FRYING COMPOUND FROM TANK.

IMPORTANT:
IF POWER IS MISTAKENLY TURNED OFF DURING THE FILTERING OPERATION, THE CORRECTIVE ACTION IS AS FOLLOWS:

1. CLOSE DRAIN VALVE
2. TURN POWER SWITCH ON
3. **IMMEDIATELY** OPEN DRAIN VALVE
4. CONTINUE FILTERING OPERATION PER STEPS 1-6

NOTE: NOT RECOMMENDED TO BE USED WITH SOLID SHORTENING.

Filtering Instructions for KleenScreen PLUS® Fryers with Computer Controls

VULCAN FRYERS COMPUTER CONTROLS GUIDE



FILTERING in 6 Easy Steps (for revisions V2.70 or higher)

STEPS 1-3

TIP: Use provided crumb scoop to remove and suspend crumbs on the bottom of tank before proceeding to Step 1.

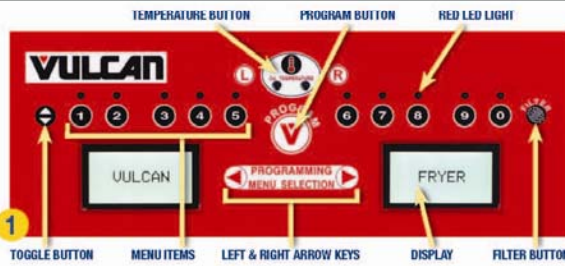

Make sure that the Power Switch is in the "ON" position. Fryer must have power to operate the motor/pump. Fryer Temperature should be between 300-350 Degrees Fahrenheit. **RECOMMENDED: ADD OIL TREATMENT MEDIA.**

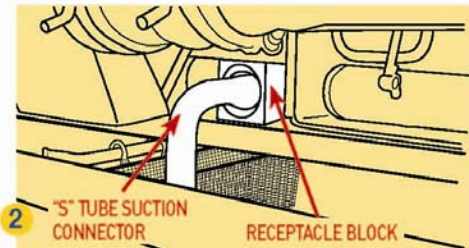

Open the fryer doors and ensure that the filter drawer is pushed back into place under the fryer with the "S" Tube Suction Connector and Receptacle Block engaged. Filter switch behind the door must be in the filter position (not on hose).



- Turn the drain valve to allow the oil to drain into the filter pan below. The fryer will automatically turn off.
- While draining the tank, use a crumb scoop to move the residue at the bottom and sides of the tank down into drain tube.
- To turn on the filter motor/pump, push the FILTER button located on the control panel, holding it for approximately 3 seconds.
- Allow the oil to cycle through the filtering operation for about 3 minutes or until satisfied that the oil and fry tank are clean. **DRAINING OIL** displays.

TIPS: Use provided tank brush to clean and remove food particles on the fry tank. Use provided clean-out rod to clear drain if clogging occurs.

STEPS 4-6



- When filtering is finished, close the red drain valve by turning the red drain handle. **FILL VAT** displays.
- Allow all of the oil to flow back into the fryer from the filter pan. It is normal to see air bubbles in the tank toward the end of filtering.



- When the filter pan is empty, push the FILTER button to turn off the motor/pump.
- Oil level should be between the Min/Max lines on the tank back. **VAT FULL ? PUSH TEMP** displays. (Display is asking if the tank is full.)



Once the oil level has been checked and verified, press the TEMP button. The fryer will automatically turn back on and the fryer will resume heating. **HEATING** displays if oil temperature is below set temperature.

DRAINING AND DISCARDING OIL FROM THE FRYER

A Follow filtering instructions steps 2 - 4, however **DO NOT** put oil treatment media into fryer. Drain the fryer oil into the filter pan.

- B** Attach the quick disconnect hose to the discard male quick disconnect fitting. Do not connect hose while motor/pump is running.
 - C** Place other end of the discard hose into a container that is large enough to retain the discarded shortening.
 - D** To start the discard operation, filter switch behind door must be in the "use hose to discard only" position.
- YOU MUST USE THE FILTER BUTTON ON THE COMPUTER CONTROL TO DISCARD THE OIL.** Press the FILTER button on the computer control and hold for approximately 3 seconds to activate the motor/pump. Oil will begin to flow through the hose and into the container. PLEASE NOTE that the display will not change for this operation.
- E** To turn off the motor/pump, simply push the FILTER button on the computer control again. Push the filter switch behind door back to the "use hose to rinse & fill" position. Disconnect the discard hose. Be careful to let the hose drain before putting away. Close the drain valve and refill the fry tank with new oil.

WARNING: Hose connection will be HOT. Use protective heat resistant gloves when handling.

NOTE: If discard vessel is not large enough to hold the entire shortening amount, stop the flow by pushing the FILTER button to turn the motor/pump off. Empty the container and resume discard operation by pushing the FILTER button and holding it for approximately 3 seconds. **THESE INSTRUCTIONS ARE FOR FRYERS WITHOUT REAR OIL RECLAMATION CONNECTIONS**

NOTICE Open the filtering drawer approximately 1" to allow any oil in the return line to run back into the filter pan. This will take about 30 seconds to complete. Then open the drawer completely to clean filter components. **THESE INSTRUCTIONS ARE FOR FRYERS WITHOUT REAR OIL RECLAMATION CONNECTIONS..**

WARNING

HOT FRYING COMPOUND AND PARTS CAN CAUSE BURNS. USE CARE WHEN OPERATING, CLEANING, OR SERVICING THE FRYER. USE CARE WHEN FILTERING. DO NOT LEAVE UNATTENDED.

SPILLING HOT FRYING COMPOUND CAN CAUSE SEVERE BURNS. DO NOT MOVE THE FRYER WITHOUT FIRST DRAINING ALL FRYING COMPOUND FROM TANK.

IMPORTANT: IF POWER IS MISTAKENLY TURNED OFF DURING THE FILTERING OPERATION, THE CORRECTIVE ACTION IS AS FOLLOWS:
 1. CLOSE DRAIN VALVE
 2. TURN POWER SWITCH ON
 3. IMMEDIATELY OPEN DRAIN VALVE
 4. CONTINUE FILTERING OPERATION PER STEPS 1-6

NOTE: NOT RECOMMENDED TO BE USED WITH SOLID SHORTENING.

FILTERING TIP:

Open the filtering drawer approximately 1" to allow any oil in the return line to run back into the filter pan. This will take about 30 seconds to complete. Then open the drawer completely to clean filter components.

REMOVING EXCESS DEBRIS FROM THE SCREEN FILTER:

1. Pull the filter drawer out and remove the crumb basket and empty any debris into the trash.
2. Remove the filter screen assembly. Scrape debris from the filter screen. Then remove the insert by unlatching the latch. Clean all parts thoroughly as mentioned in the Assembly section on page 19.
3. Scrape debris from the bottom of the filter pan and discard in the trash. Clean all parts thoroughly as mentioned in the Assembly section on page 19. Clean all parts thoroughly as mentioned in the Assembly section on page 19.
4. Reassemble all filter components after being dried thoroughly as in the Assembly section on page 19.

FLUSH AND DISCARD:

1. Follow filtering instructions 1-3, however do not put oil treatment media into the fryer. Drain the fryer oil into the filter pan.
2. Attach the quick disconnect hose to the discard male quick disconnect fitting, (hose not supplied with fryer – Accessory Option).
3. Place other end of the discard hose into a container that is large enough to retain the discarded shortening.
4. With the power switch still ON; press the discard/flush switch on. Press and hold the filter button for at least 3 seconds and the Motor/Pump will begin to operate. NOTE: Oil will come out immediately out of the nozzle end of the hose.
5. Once the oil has been discarded completely and the filter pan is empty, press the filter button to turn off the Motor/ Pump. Then press the discard/flush switch off.
6. Disconnect the discard hose. The hose connection will be hot due to the temperature of the oil that was discarded. Be careful to let the hose drain before putting away. Close the drain valve and fill the fry tank with new oil.
- 7.

BOIL OUT PROCEDURE:

Use the Boil Out By-Pass™ drain extension allowing the boil out solution to exit the fry tank without using the filtering system. Do NOT allow water to run through the motor / pump. Drain the boil out solution into a bucket or place a high temperature rated water hose on the end of the drain extension allowing the other end to flow into a floor drain. In Fig. 6 the arrow is pointing to the drain extension. It is threaded into the top coupling of the oil drain tube. Drain extension needs to be only hand tightened.

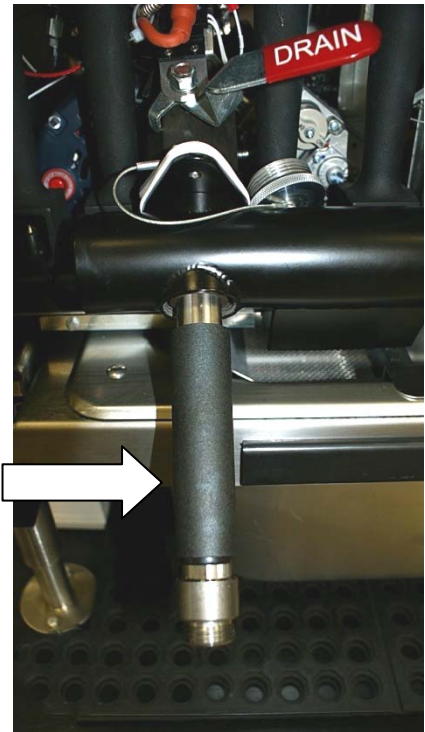
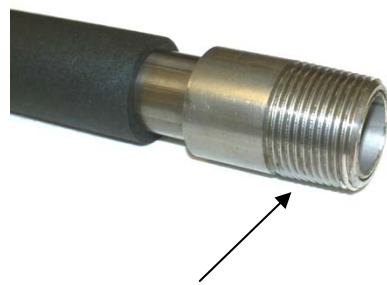

Fig. 6



Standard Hose End



Drain Tube End

THERMAL OVERLOAD PROTECTION BUTTON:

The motor/pump supplied with the filtering system has a thermal overload protection circuit that senses when excess heat occurs. This can occur due to filtering for long periods of time or under heavy load prior to discarding debris buildup. If the thermal overload protection is tripped, wait 5 minutes and then reset the motor by pushing in the red button. The arrow in Figure 7 shows the location of the reset button; located on the front of the motor / pump facing towards you.

⚠ WARNING Hot oil and hot parts can cause burns.

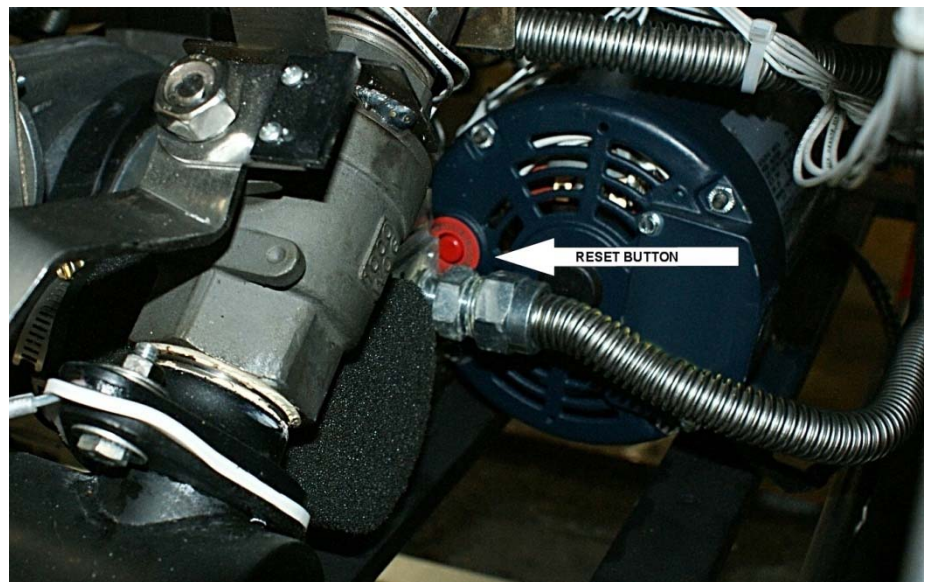

Fig. 7

MAINTENANCE

▲ WARNING Hot oil and hot parts can cause burns. Use care when operating, cleaning, and servicing the fryer.

▲ WARNING Spilling hot fryer compound can cause severe burns. Do not move fryer without draining all frying compound from the tank.

FLUE VENT INSPECTION

When the fryer is cool, inspect annually. Check the flue and clear any obstructions.

Service in the US and Canada

Contact you local Vulcan-Hart Service office or address on the front of this manual.

ALARMS AND ERROR MESSAGES

NO OR LOW GAS SUPPLY – If no action is taken after 90 seconds, an alarm sounds continuously, the heat demand is disabled and any running cooking cycles are cancelled. The digital display the following message:

“D” Solid State – IGNITION LOCKOUT

“C” Computer – IGNITION LOCKOUT CHECK GAS SUPPLY

The fryer must be turned off, then back on to re-initialize the control and to have normal functions resumed.

OPEN PROBE – If an open probe is detected, the heat demand is disabled and any running cooking cycles are cancelled. All operator buttons are disabled. The digital control displays the following message:

“D” Solid State – OPEN PROBE

“C” Computer – PROBE OPEN

SHORTED PROBE – If a shorted probe is detected, the heat demand is disabled and any running cooking cycles are cancelled. All operator buttons are disabled. The digital control displays the following message:

“D” Solid State – SHORTED PROBE

“C” Computer – PROBE SHORT

Hi TEMPERATURE – If the temperature is greater than or equal to 415°F (212°C), the heat demand is disabled and any running cooking cycles are cancelled. All operator buttons are disabled. The control displays the following message:

“D” Solid State – HIGH TEMP

“C” Computer – HIGH TMP HIGH TMP

Troubleshooting Chart:	
Problem:	Probable Cause:
No Heat:	Power switch not turned on. Gas supply not turned on. Wire connections loose (call service) Wires connections need cleaning High Limit (call service)
Insufficient or too much heat:	Temperature not set to desired temperature. High limit tripped (call service) Temperature probe (call service)
Tank will not drain:	Shortening too cold. Drain pipe clogged with debris.
Motor / pump will not pump oil:	Suction tube not seated correctly in receptacle block. Filter screen is clogged and needs cleaning. Shortening is too thick / cold. Heat oil up to min. 300° F. Discard valve lever not fully engaged either for filtering or discarding.