

*Sunbeam*

# Classic® Electric Fryware Range

Instruction/Recipe Booklet

This book covers the use and care of the following Sunbeam Electric Fryware:

FP5500P	Classic®	28cm (11")	Square Frypan & Roaster
FP5610P	Classic® Super Deep	28cm (11")	Square Non-stick Deep Frypan & Roaster
FP5900P	Family Banquet™	38cm (15")	Rectangle Non-stick Deep Frypan & Roaster
FP5910	Classic® Banquet	38cm (15")	Rectangle Non-stick Deep Frypan
FP5920	Minerale Classic® Banquet	38cm (15")	Rectangle Non-stick Deep Frypan
SK4200P	Classic® Skillet	25cm (10")	Round Non-stick Skillet

Please read these instructions carefully and retain for future reference.



# Contents

<b>Sunbeam's Safety Precautions</b>	<b>1</b>
<b>Features of your Sunbeam Fryware</b>	
<b>Sunbeam Classic® Frypan – FP5500P</b>	<b>2</b>
<b>Sunbeam Classic® Super Deep Frypan – FP5610P</b>	<b>4</b>
<b>Sunbeam Family Banquet™ Frypan – FP5900P</b>	<b>6</b>
<b>Sunbeam Classic® Banquet Frypan – FP5910, FP5920</b>	<b>8</b>
<b>Sunbeam Classic® Skillet – SK4200P</b>	<b>10</b>
<b>DuPont Teflon® Platinum Pro non-stick</b>	<b>12</b>
<b>Temperature setting guide</b>	<b>13</b>
<b>Using your Sunbeam Fryware</b>	<b>14</b>
<b>Cooking with your Sunbeam Fryware</b>	<b>15</b>
<b>Care and Cleaning</b>	<b>17</b>
<b>Frypan Recipes</b>	<b>18</b>
<b>Skillet Recipes</b>	<b>30</b>

تأكد من تفهم احتياطات السلامة المذكورة اعلاه

請務必理解上述的安全預防措施。

Assurez-vous que les précautions ci-dessus relatives à la sécurité sont bien comprises

Versichern Sie sich daß die obenstehenden Sicherheitsmaßnahmen Verstanden werden

Βεβαιώστε πως οι παραπάνω προφυλάξεις ασφαλείας γίνονται κατανοητές

Pastikan bahwa tindakan-tindakan keselamatan seperti di atas dimengerti anda

Accertatevi che le suddette norme di sicurezza siano comprese a dovere

上記の注意事項をよくお読みになり、安全を御確認ください

Уверете се дека погоре споменатите мерки на претпазливост се добро разбрани

Asegúrese de que las precauciones de seguridad precedentes sean bien comprendidas

کاری بکنید کہ احتیاطهای بالا حتماً درک بشوند

ต้องแน่ใจว่า ข้อควรระวังเรื่องความปลอดภัยข้างต้น เป็นที่เข้าใจกันดี

Yukarda belirtilen güvenlik önlemlerinin anlaşıldığından emin olunuz

Xin kiểm chắc rằng những biện pháp làm an toàn kể trên được hiểu rõ

# Sunbeam's Safety Precautions

## SAFETY PRECAUTIONS FOR YOUR SUNBEAM FRYPAN.

- Use your frypan at least 200mm away from walls and curtains.
- Do not immerse the control probe in water.
- If using a plastic spatula do not leave in cooking vessel when hot.
- The frypan must only be used with the control probe provided.
- Avoid using on metal surfaces e.g. sink, hotplate.
- Remove the control probe before cleaning the frypan.
- After cleaning the frypan ensure that the control probe Inlet area is completely dry before using again.

**Sunbeam is very safety conscious when designing and manufacturing consumer products, but it is essential that the product user also exercise care when using an electrical appliance. Listed below are precautions which are essential for the safe use of an electrical appliance:**

- Read carefully and save all the instructions provided with an appliance.
- Always turn the power off at the power outlet before you insert or remove a plug. Remove by grasping the plug - do not pull on the cord.
- Turn the power off and remove the plug when the appliance is not in use and before cleaning.
- Do not use your appliance with an extension cord unless this cord has been checked and tested by a qualified technician or service person.
- Always use your appliance from a power outlet of the voltage (A.C. only) marked on the appliance.
- This appliance is not intended for use by persons (including children) with reduced physical, sensory or mental capabilities, or lack of experience and knowledge, unless they have been given supervision or instruction concerning use of the appliance by a person responsible for their safety.
- Children should be supervised to ensure that they do not play with the appliance.
- The temperature of accessible surfaces may be high when the appliance is operating.
- Never leave an appliance unattended while in use.
- Do not use an appliance for any purpose other than its intended use.
- Do not place an appliance on or near a hot gas flame, electric element or on a heated oven.
- Do not place on top of any other appliance.
- Do not let the power cord of an appliance hang over the edge of a table or bench top or touch any hot surface.
- Do not operate any electrical appliance with a damaged cord or after the appliance has been damaged in any manner. If damage is suspected, return the appliance to the nearest Sunbeam Appointed Service Centre for examination, repair or adjustment.
- For additional protection, Sunbeam recommend the use of a residual current device (RCD) with a tripping current not exceeding 30mA in the electrical circuit supplying power to your appliances.
- Do not immerse the appliance in water or any other liquid unless recommended.
- Appliances are not intended to be operated by means of an external timer or separate remote control system.
- This appliance is intended to be used in household and similar applications such as: staff kitchen areas in shops, offices and other working environments; farm houses; by clients in hotels, motels and other residential type environments; bed and breakfast type environments.

If you have any concerns regarding the performance and use of your appliance, please visit [www.sunbeam.com.au](http://www.sunbeam.com.au) or contact the Sunbeam Consumer Service Line.

Ensure the above safety precautions are understood.

# Features of your Sunbeam Classic® Frypan – FP5500P

## **Integrated knob and adjustable steam vent**

Allows you to accurately control moisture levels during cooking.

## **Adjustable lid holder**

A stepped catch on the side of the lid enables the lid to be tilted above the frypan, to help maintain the temperature selected. Both hands are then free for stirring and turning foods. When the lid is in position it acts as a splatter shield. The lid can rest on either of the sides without handles.

## **Cool touch handles and lid knob**

For safer cooking and carrying of the frypan.

## **Tough wearing cooking surface**

A durable, multi-purpose finished aluminium cooking surface.

## **Dishwasher safe**

The pan and base are dishwasher safe and fully immersible making cleaning a breeze.

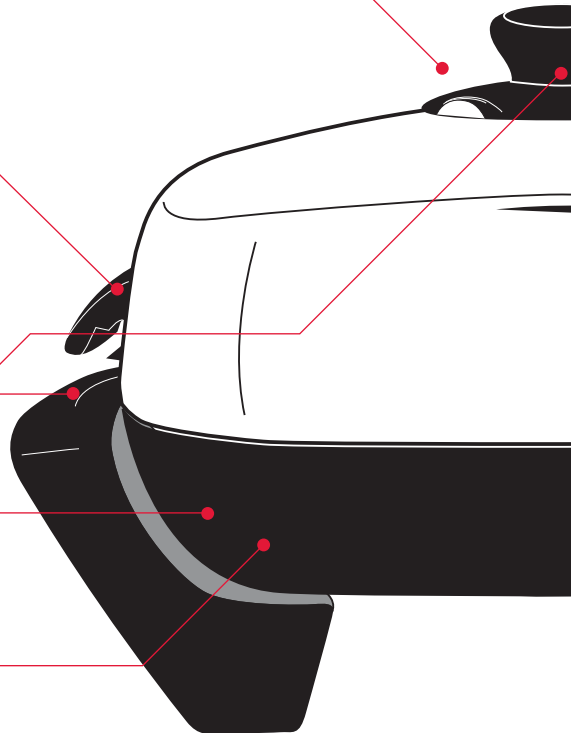

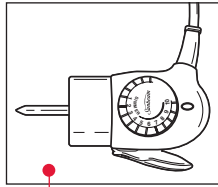
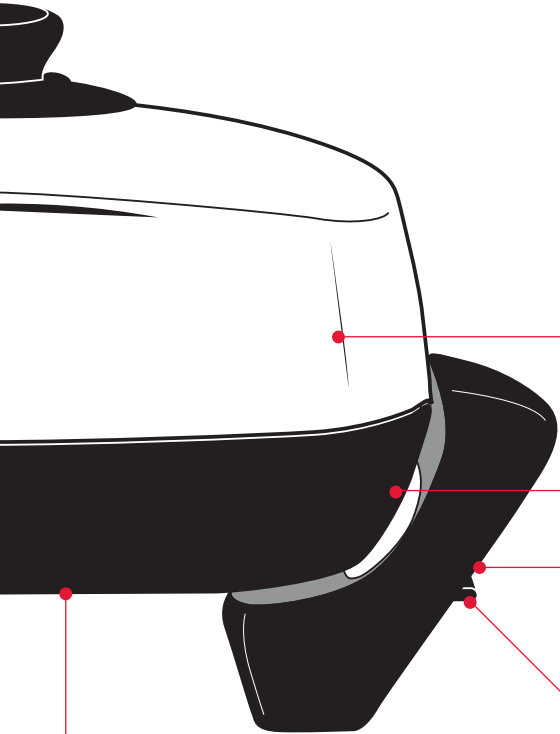

**Trigger release control probe**

The probe is thermostatically controlled and incorporates an indicator light that switches off automatically when the selected temperature has been reached, it then cycles on and off to indicate that the temperature is being maintained.

**High domed metal lid**

Turns your frypan into a compact oven. Ideal for roasts, stews and casseroles.

**28cm (11") square frypan**

**Control probe inlet**

**Cast-in element**

The element is completely cast into the heavy duty base providing superior heat distribution, faster heating and a longer element life.

**Pan tilt lever**

When the lever is in the lowered position the cooking pan is tilted, forcing juices to collect at one end of the pan. Both hands are then free for basting.

# Features of your Sunbeam Classic<sup>®</sup> Super Deep Frypan – FP5610P

## **Integrated knob & adjustable steam vent**

Allows you to accurately control moisture levels during cooking.

## **Adjustable lid holder**

A stepped catch on the side of the lid enables the lid to be tilted above the frypan, to help maintain the temperature selected. Both hands are then free for stirring and turning foods. When the lid is in position it acts as a splatter shield.

## **Cool touch handles and lid knob**

For safer cooking and carrying of the frypan

## **DuPont Teflon<sup>®</sup> Platinum Pro™ non-stick cooking surface**

Enables healthy fat-free cooking and simple wipe down cleaning. Three layers of premium scratch and abrasive resistant non-stick coating. Safe to use with metal utensils.



## **Extra deep cooking vessel (78mm)**

Ideal for the largest roasts, family size meals or liquid based dishes.

## **Dishwasher safe**

The pan and base are dishwasher safe and fully immersible making cleaning a breeze.

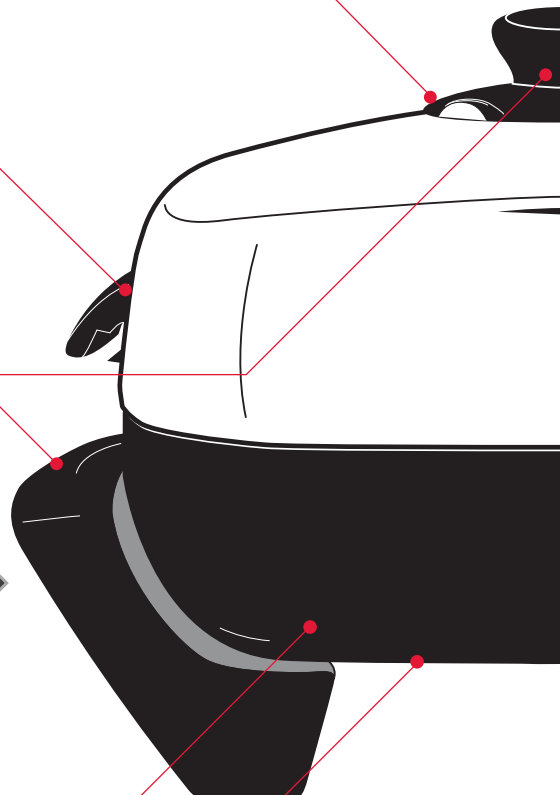

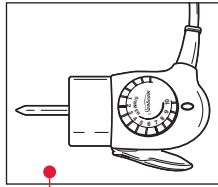
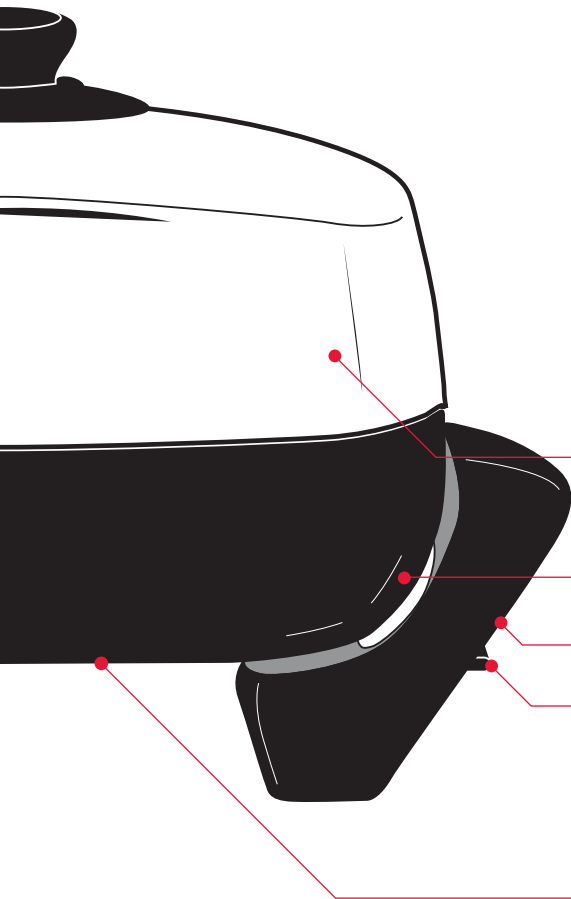

**Trigger release control probe**

The probe is thermostatically controlled and incorporates an indicator light that switches off automatically when the selected temperature has been reached, it then cycles on and off to indicate that the temperature is being maintained.

**High domed metal lid**

Turns your frypan into a compact oven. Ideal for roasts, stews, and casseroles.

**28cm (11") square frypan**

**Control probe inlet**

**Pan tilt lever**

When the lever is in the lowered position the cooking pan is tilted, forcing juices to collect at one end of the pan. Both hands are then free for basting.

**Cast-in square element**

The powerful 2000 watt square element is completely cast into the heavy duty base providing superior heat distribution.

# Features of your Sunbeam Family Banquet Frypan – FP5900P

## Integrated knob and adjustable steam vent

Allows you to accurately control moisture levels during cooking.

## High domed metal lid

Turns your frypan into a compact oven. Ideal for roasts, stews and casseroles.

## DuPont Teflon® Platinum Pro™ non-stick cooking surface

Enables healthy fat-free cooking and simple wipe down cleaning. Three layers of premium scratch and abrasive resistant non-stick coating. Safe to use with metal utensils.



## Cool touch handles and lid knob

For safer cooking and carrying of the frypan

## Control probe inlet

## Pan tilt lever

When the lever is in the lowered position the cooking pan is tilted, forcing juices to collect at one end of the pan. Both hands are then free for basting.

## Dishwasher safe

The pan and base are dishwasher safe and fully immersible making cleaning a breeze.

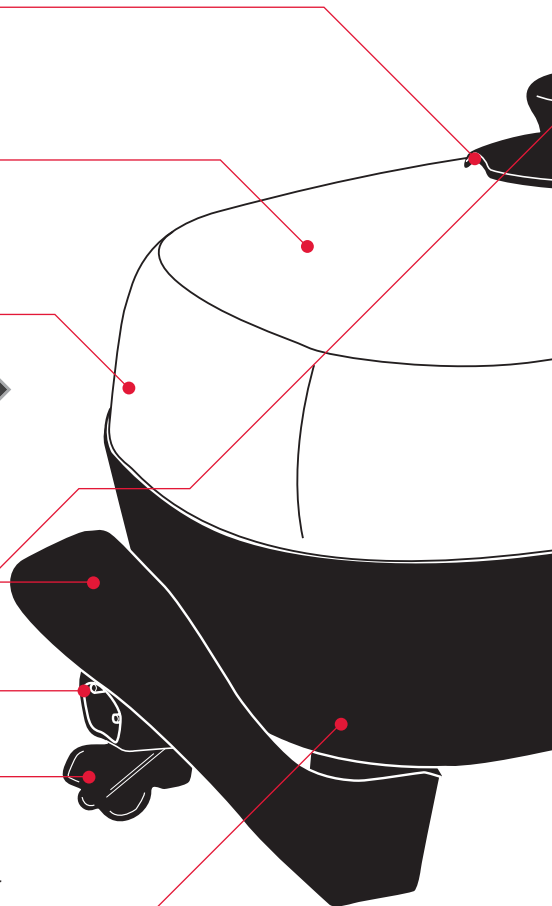



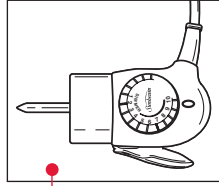

### **Trigger release control probe**

The probe is thermostatically controlled and incorporates an indicator light that switches off automatically when the selected temperature has been reached, it then cycles on and off to indicate that the temperature is being maintained.

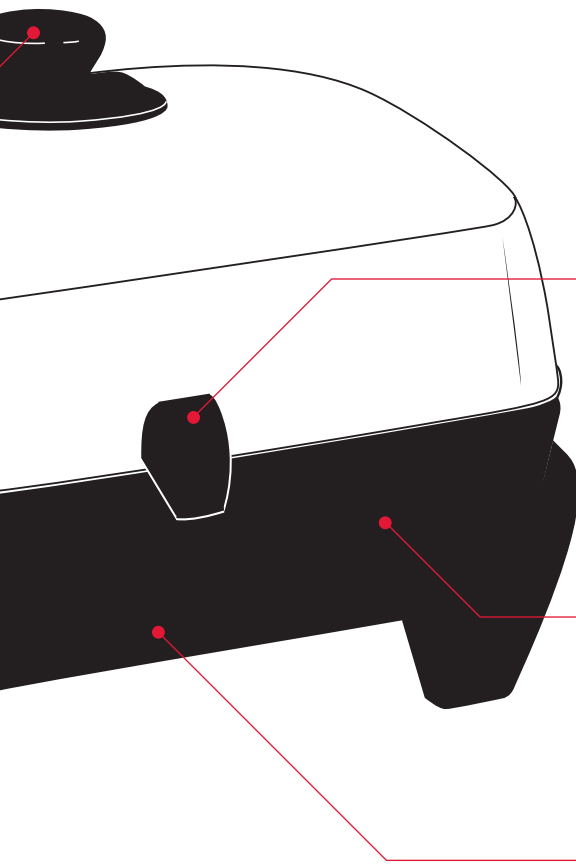

### **Adjustable lid holder**

A stepped catch on the side of the lid enables the lid to be tilted above the frypan, to help maintain temperatures. Both hands are then free for stirring and turning foods. When the lid is in position it acts as a splatter shield. The lid can rest on either of the sides without handles.

### **Extra large cooking vessel**

The large rectangular frypan (38cm (15") x 29.5cm (11.5")) is 78mm deep, ideal for cooking 2 chickens, the largest roasts, family size meals or liquid based dishes.

### **Cast-in rectangle element**

The powerful 2400 watt rectangle element is completely cast into the heavy duty base providing superior heat distribution, faster heating and a longer element life.

# Features of your Sunbeam Classic® Banquet Frypan – FP5910, FP5920

## Integrated knob and adjustable steam vent

Allows you to accurately control moisture levels during cooking.

## DuPont Teflon® Platinum Pro™ non-stick cooking surface

Enables healthy fat-free cooking and simple wipe down cleaning. Three layers of premium scratch and abrasive resistant non-stick coating. Safe to use with metal utensils.



## Cool touch handles and lid knob

For safer cooking and carrying of the frypan

## Control probe inlet

## Pan tilt lever

When the lever is in the lowered position the cooking pan is tilted, forcing juices to collect at one end of the pan. Both hands are then free for basting.

## Dishwasher safe

The pan, base and lid are dishwasher safe and fully immersible making cleaning a breeze.



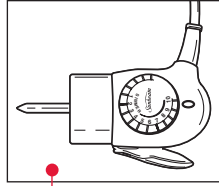

**Trigger release control probe**

The probe is thermostatically controlled and incorporates an indicator light that switches off automatically when the selected temperature has been reached, it then cycles on and off to indicate that the temperature is being maintained.

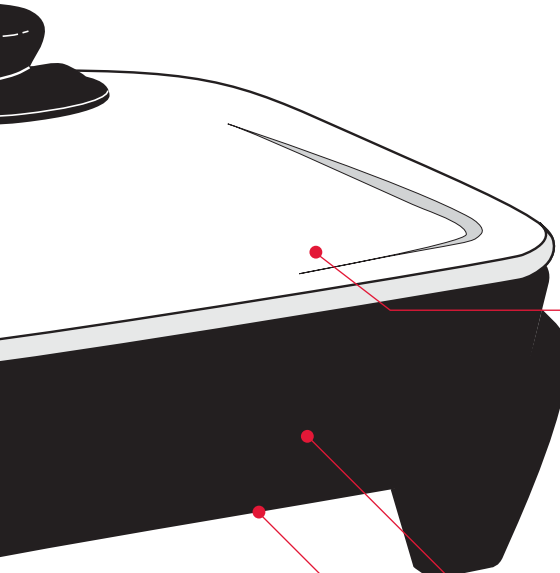

**Glass lid**

The clear glass lid allows you to monitor the cooking process without lifting the lid and allowing the heat to escape, ensuring the selected temperature is maintained.

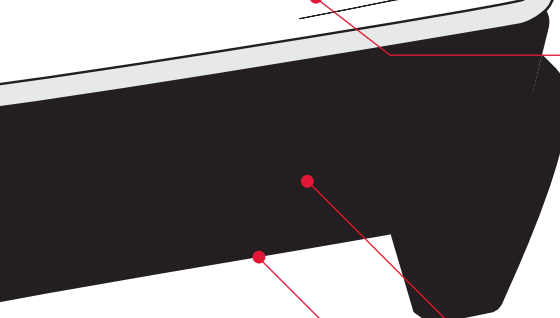

**Extra large cooking vessel**

The large rectangular frypan (38cm (15") x 29.5cm (11.5")) is 78mm deep, ideal for cooking 2 chickens, roasts, family size meals or liquid based dishes.

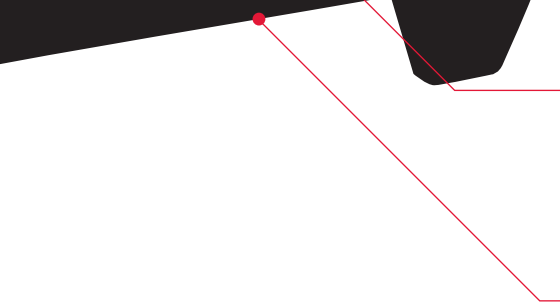

**Cast-in rectangle element**

The powerful 2400 watt rectangle element is completely cast into the heavy duty base providing superior heat distribution, faster heating and a longer element life.

# Features of your Sunbeam Classic<sup>®</sup> Skillet – SK4200P

---

## **Integrated knob & adjustable steam vent**

Allows you to accurately control moisture levels during cooking.

---

## **Cool touch handle and lid knob**

For safer cooking and carrying of your skillet.

---

## **Control probe inlet**

---

## **Cast-in element**

The 1200 watt element is completely cast into the heavy duty base providing superior heat distribution, faster heating and a longer element life.

---

## **Dishwasher safe**

The pan and base are dishwasher safe and fully immersible making cleaning a breeze.

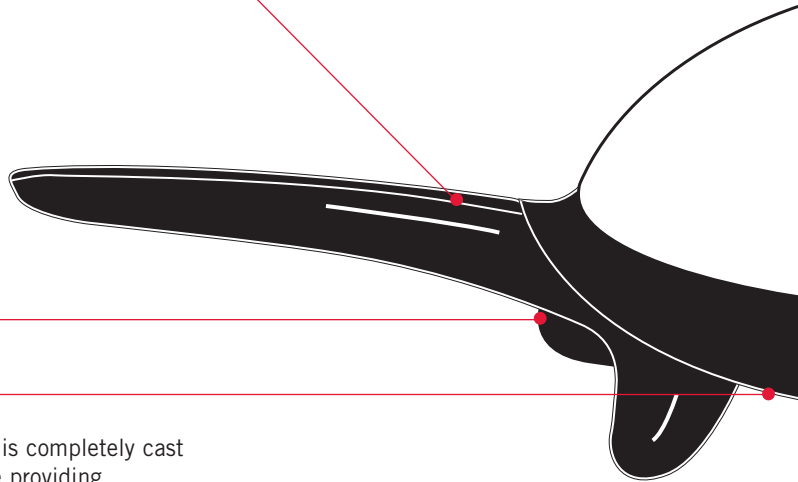

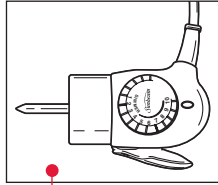

### **Trigger release control probe**

The probe is thermostatically controlled and incorporates an indicator light that switches off automatically when the selected temperature has been reached, it then cycles on and off to indicate that the temperature is being maintained.

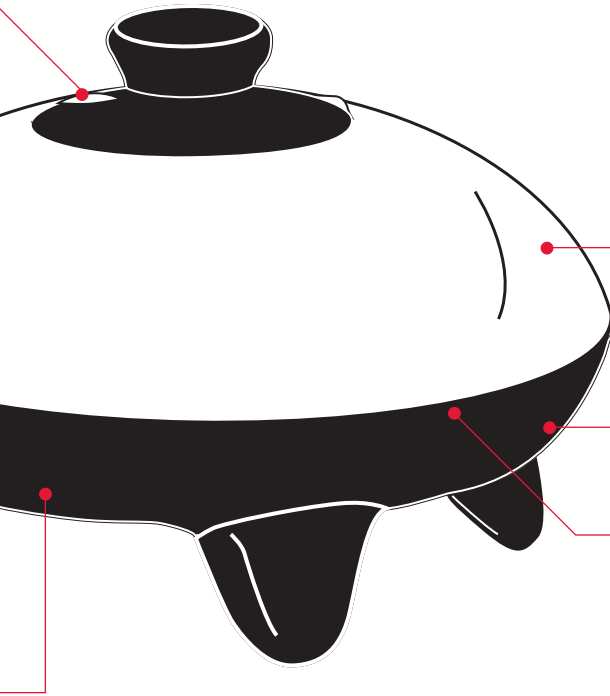

### **High domed metal lid**

Turns your skillet into a compact oven. Ideal for small roasts, chicken or steaming.

### **25cm (10") electric skillet**

### **DuPont Teflon® Platinum Pro™ non-stick cooking surface**

Enables healthy fat-free cooking and simple wipe down cleaning. Three layers of premium scratch and abrasive resistant non-stick coating. Safe to use with metal utensils.



# DuPont Teflon® Platinum Pro™ Professional Use



Your Sunbeam frypan features a special scratch and abrasive-resistant non-stick cooking coating that makes it safe to use metal utensils when cooking. Teflon® Platinum Pro Professional Use is DuPont's toughest non-stick coating to date – up to 10 times more scratch resistant than other single layer non-stick coatings.\*

DuPont is the world leader in non-stick coatings and today more than 2 billion households have Teflon® non-stick coated cookware.

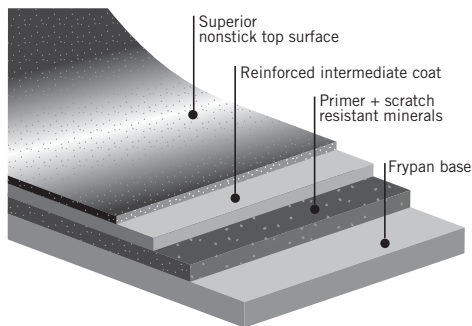

*Platinum Pro™ - non-stick - 3 layer scratch resistant coating*

Teflon® Platinum Pro™ is a premium 3 layer non-stick coating. It features special scratch resistant minerals causing metal utensils to slide over these particles without damaging the Teflon matrix. This preserves the release properties of the non stick coating and the life of the frypan.

The result is a non-stick coating that can be treated like ordinary cookware, enabling the use of metal utensils. However, Sunbeam recommends that care is taken with the non-stick coating when using metal utensils.

Do not use sharp objects or cut food inside the frypan. Damage caused to your frypan as a result of misuse of metal utensils will void your warranty.

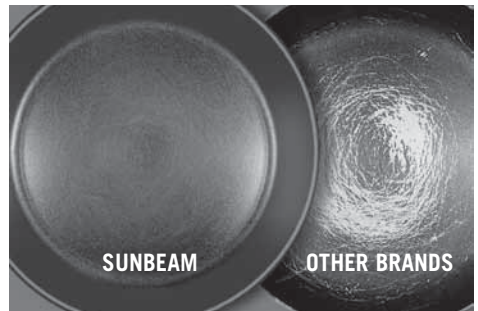

*Results from DuPont's 'In-house Cooking Abuse Test'*

*\* The images shown here and performance claims are based upon the DuPont In-house Cooking Abuse Test used to evaluate scratch resistance and release properties of non-stick coatings.*

# Temperature setting guide

The numbers on the dial represent the following temperatures approximately.

## Calibration of your frypan

Preheat your frypan on setting 7-8. When the light goes out, put in your ingredients and change to your desired setting.

DIAL SETTING	CELSIUS (approx)	FAHRENHEIT (approx)	SUGGESTED USES	TEMPERATURE
1 2	100°C 110°C	210°F 230°F	Keeping food warm	<b>LOW</b>
3 4	125°C 140°C	260°F 285°F	Simmering, slow cooking	
5 6	150°C 160°C	300°F 320°F	Pan frying, roasting	<b>MEDIUM</b>
7 8	175°C 185°C	350°F 365°F	Shallow frying	
9 10	200°C 210°C	390°F 410°F	Searing, sealing and baking	<b>HIGH</b>

**Note:** The suggested uses above are provided as a guide only and may require adjustment to suit various foods and individual tastes.

When the dial is set to a low setting, it is normal for food to stop and start bubbling, as the thermostat maintains the selected temperature.

# Using your Sunbeam Fryware

**Before the first use:** Wash, rinse and dry your frypan and lid.

1. Insert the control probe into the inlet on the frypan.
2. Plug the cord into a 230-240V power outlet and turn the power on.
3. Pre heat the frypan on setting 7-8. Then set the control probe dial to the desired temperature setting. Refer to page 13 for the temperature guide.

**Note:** The light on the control probe will illuminate and will remain on until the set temperature is reached. It will then cycle on and off throughout cooking, as the temperature is maintained by the thermostat. On initial heating of the frypan, it is recommended that the temperature be allowed to cycle (the light cycling on and off) several times. This will help the cooking surface to adjust to a more accurate cooking temperature.

## Adjustable lid holder

(Models FP5500P, FP5610P, FP5900P)

This is a stepped catch on the side of the lid. It allows the lid to rest above the frypan and eliminates the need to find a spot on the bench. When in position the lid also acts as a splatter shield. The lid can rest on either side without handles, making it easy for left

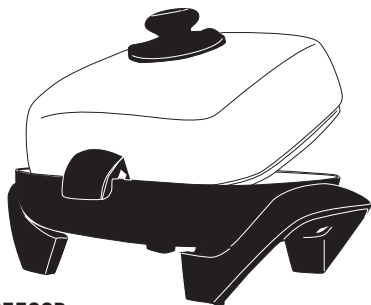

FP5500P

or right handed use.

## Using the pan tilt lever

(Models FP5500P, FP5610P, FP5900P, FP5910, FP5920)

The pan tilt lever is positioned under the inlet where the control probe is inserted.

To tilt the frypan, push the lever down. This allows the fat and juices to drain from the

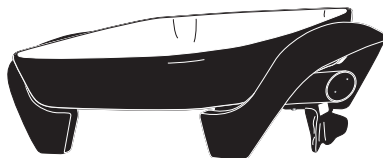

FP5500P

food for crisp, low fat cooking. It also makes it easier to baste food and serve sauces or gravy.

## Trigger release control probe

The probe is thermostatically controlled and incorporates an indicator light which switches off automatically when the temperature selected has been reached. It then cycles on and off to indicate that the selected temperature is being maintained.



# Cooking with your Sunbeam Fryware

## Baking

(Models FP5500P, FP5610P, FP5900P, FP5910, FP5920)

Your frypan can be used for baking cakes, with deliciously moist results.

1. Preheat the frypan to setting 10, with the lid on.
2. Elevate the cake pan or tray from the base of the frypan using a small wire rack.

Cooking times will be longer than those of a conventional oven.

## Basting

(Models FP5500P, FP5610P, FP5900P, FP5910, FP5920)

The pan tilt lever makes basting easy as it allows the juices to drain to one side of the pan. Reduce the temperature to prevent any fat and juices splattering. Position the pan tilt lever and spoon the juices over the food as desired.

## Boiling Pasta

(Models FP5500P, FP5610P)

1. Bring 6 cups of water to the boil on setting 5.
2. Add 250g (1½ cups) of pasta and cook until tender, for approximately 8-12 minutes.
3. Reduce to a lower setting if the water boils too rapidly.

**Note:** Cooking times will vary with different types of pasta.

## Boiling Rice

(Models FP5500P, FP5610P)

1. Bring 6 cups of water to the boil on setting 5. Add 200g (1 cup) of rice and position the lid.
2. Cook until tender, approximately 10-12 minutes, and then drain.
3. Reduce to a lower setting if the water boils too rapidly. Stir occasionally so that the rice does not stick.

## Browning and Sealing Meat

(All models)

It is necessary to brown and seal meat in many recipes. Meat retains its juices and the flavours develop after browning and sealing. This also prevents it from sticking when baking or roasting. Preferably use meat that is at room temperature, as this reduces the cooking time.

1. Preheat the frypan to settings 8-9.
2. Brown meat on all sides, with the lid off.
3. After sealing, reduce the temperature to settings 4-5 and replace the lid until the meat is cooked as desired.

# Cooking with your Sunbeam Fryware continued

## Frying

### (All models)

The frypan is ideal for shallow or dry frying. Deep frying is not particularly suitable as the frypan has shallow sides and a greater surface area, which results in heat loss and the possible overflow of oil.

**Pan frying:** Suitable for eggs, omelettes, bacon, sausages, steaks and chicken pieces. Preheat to settings 5-6 with a little oil to add flavour. Non-stick cooking surfaces do not require a large amount of oil. Steaks should only be turned once during cooking.

**Shallow frying:** Suitable for vegetable pieces e.g roast pumpkin and potato, and crumbed food. Preheat on settings 6-8 with sufficient oil so that the food is half immersed. Cook food with the lid off.

**Sautéing:** Preheat on settings 5-6 with a little oil to add flavour.

**Stir frying:** Food is cooked quickly, over a high heat and vegetables retain their flavour and crispness. For best results and even cooking, cut food into even sized, smaller pieces.

1. Preheat the frypan on settings 8-9 with a little oil.
2. Slice meat into strips. Coat meat in a little oil and stir-fry in batches until browned. This prevents meat from stewing.
3. Add vegetables and seasoning, stirring continuously. Vegetables which take longer to cook, such as carrots, should be cooked first, adding the other ingredients later. Cook until the vegetables are crisp. Return the meat back into the pan when the vegetables are almost cooked. The lid can be in position in the last few minutes of cooking.

## Roasting

### (All models)

**Meat and poultry:** The frypan is ideal for roasting meat and poultry, as the meat retains the flavour and juices.

1. Preheat the frypan to settings 8-9. Use only a small amount of oil for less fatty joints and no oil for fattier joints of meat.
2. Brown and seal the meat on all sides and position the lid.
3. After browning, turn the dial to settings 4-5 to cook the meat as desired. Turn meat occasionally during cooking to ensure even cooking.
4. Remove meat from pan and cover with foil. Allow meat to rest for 5-10 minutes, meanwhile you can make a gravy from the juices in the frypan.

**Vegetables:** Cut into even sized pieces. Add to the frypan 45-60 minutes before serving. For crisper vegetables, remove the meat and increase the heat for the last few minutes of cooking.

### Roasting times:

**Note:** These times are for well done. Reduce the times to suit personal taste.

PORK	30-40 minutes per 500g after browning.
VEAL	30-40 minutes per 500g after browning.
BEEF	20-25 minutes per 500g after browning.
LAMB	25-30 minutes per 500g after browning.
CHICKEN	30-35 minutes per 500g after browning.

# Care and Cleaning

Always turn the power off and remove the plug from the power outlet after use and before cleaning. Allow appliance to cool before cleaning.

## Control probe

If cleaning is necessary, wipe over with a damp cloth.

**Note:** The control probe must be removed before the frypan or skillet is cleaned and the control probe inlet must be dried before the frypan or skillet is used again.

**Important: Do not immerse the control probe in water or any other liquid.**

Store the control probe carefully. Do not knock or drop it as this can damage the probe. If damage is suspected, return the control probe to your nearest Sunbeam Appointed Service Centre for inspection.

## High domed metal lid

(Models: FP5500P, FP5610P, FP5900P, SK4200P)

Wash the lid in warm soapy water using a soft sponge, rinse and dry thoroughly. Metal scourers will scratch the surface and should be avoided. Some food such as tomato paste and curry may stain the surface. This staining may be removed or reduced by rubbing with a cream cleanser or a paste of bicarbonate of soda and water.

**Note:** Do not place metal lid in a dishwasher.

## Glass lid (FP5910, FP5920)

Wash the lid in warm soapy water using a soft sponge, rinse and dry thoroughly. Alternatively, wash the lid in a dishwasher.

## To clean interior and exterior surface

- When cleaning the Teflon Platinum Pro non-stick coating do not use metal (or other abrasive) scourers. After cleaning, dry the frypan/skillet and lid with a soft cloth before storing.
- Wash the pan and base in hot soapy water or in a dishwasher. Remove stubborn spots with a plastic washing pad or sponge.
- The heating element is totally sealed, making the frypan or skillet safe to fully immerse in water, or place in a dishwasher.

# Frypan Recipes

There are many recipes covered in this section for the different models of the Classic Range of Electric Frypans. Some of the recipes listed in this section will only be suitable for particular models, not necessarily the model you have purchased. For recipes for your Classic Skillet see page 30.

**Note:** The temperature settings stated in these recipes are a guide only and will vary depending on what model you are using.

---

## Minestrone

Serves 4-6

*Not suitable for model FP5500P*

- 1 tablespoon olive oil
  - 1 onion, diced finely
  - 2 cloves garlic, crushed
  - 1 carrot, diced finely
  - 2 trimmed celery stalks, diced finely
  - 1 bacon bone (200g)
  - 800g can chopped tomatoes
  - 6 cups water
  - 1 cup finely chopped savoy cabbage
  - 2 small zucchini, diced
  - 1 x 400g can cannellini beans, rinsed and drained
  - $\frac{3}{4}$  cup small pasta
  - Sea salt and freshly ground black pepper
  - shaved parmesan, to serve
1. Heat oil in frypan on setting 5. Cook onion and garlic until translucent. Add carrot, celery and bacon bone and cook, stirring occasionally for 5 minutes.
  2. Add the chopped tomatoes and water and bring the soup to the boil. Reduce heat to setting 2-3 and cook, covered for 45 minutes.
  3. Add the cabbage, zucchini, beans, pasta and season with salt and pepper. Cook, covered for a further 20-25 minutes. Add a little extra water if necessary.
  4. Serves hot with shavings of parmesan on top.

## Pumpkin Soup

Serves 4

*Double quantity recommended for FP5900P, FP5910, FP5920*

- 1.5 kg pumpkin, peeled, seeds removed
  - 2 tablespoons olive oil
  - 20g butter
  - 1 large onion, chopped
  - 1 litre low salt chicken stock
  - Sea salt & freshly ground black pepper
  - $\frac{1}{3}$  cup cream or sour cream to serve (optional)
1. Heat oil and butter in frypan on setting 4. Add onions and cook, stirring, until the onions have softened. Add pumpkin and cook for a further 3-4 minutes, stirring occasionally.
  2. Add the stock and bring to the boil. Reduce heat to setting 3 and cook, covered for 30 minutes. Cool before blending.
  3. Blend or process soup until smooth. Return pureed soup to frying pan.
  4. Reheat until soup is hot. Serve with cream and extra ground pepper if desired.

## Frypan recipes continued

### Corn Fritters

Makes approx. 20

- 1 cup self raising flour
- ½ teaspoon bicarbonate soda
- ½ teaspoon sweet paprika
- ½ teaspoon ground coriander
- ⅔ cup buttermilk
- 2 eggs
- 2 cups corn kernels
- 1 small red capsicum, diced finely
- 3 small green onions, sliced
- 2 tablespoons chopped fresh parsley
- 1 tablespoon chopped fresh coriander
- Sea salt and freshly ground black pepper
- Olive oil
- Tomato chilli jam, to serve

1. Combine flour, soda, paprika in a bowl; whisk through buttermilk and eggs to form a batter.
2. Combine corn, capsicum, green onions, parsley and coriander in a large bowl. Stir through the batter; season with salt and pepper.
3. Heat frypan on setting 8. Drizzle a little olive oil in frypan and spoon tablespoonfuls of mixture into pan. Cook fritters for 2-3 minutes on each side until golden.
4. Serve with tomato chilli jam if desired.

### Gyoza (Japanese Dumplings) Makes approx. 50

- 150g pork mince
- 150g chicken mince
- 2 tablespoons kecap manis (sweet soy)
- 1 teaspoon sugar
- 1 tablespoon mirin
- 1 egg
- 2 teaspoons sesame oil
- 2½ cups Chinese cabbage, shredded finely
- ⅓ cup finely chopped water chestnuts
- 4 green onions, chopped finely
- 50 sheets gow gee wrappers
- vegetable oil for pan frying

#### Dipping Sauce

- 2 tablespoons kecap manis
- 1 tablespoon black vinegar

1. Combine all ingredients in a bowl and mix well.
2. Lay several sheets of gow gee wrappers out onto a bench top. Have a tray lined with baking paper ready to place the prepared gyoza onto.
3. Place a rounded teaspoon of filling into the centre of the wrapper. Moisten the edges with a little water. Fold the wrapper over the filling but before sealing carefully pleat on one side. The pastry will look plain on one side but have a small pleat on the other. Gently press the pastry to seal. Repeat with remaining wrappers.
4. Heat frypan on setting 8. Heat 1 tablespoon of oil in the frying pan and place the dumplings, in batches, into the pan, pleat side up. Cook until the dumplings are golden on the bottom. Do not turn. Carefully pour enough water in the frying pan so that the dumplings are half covered. Place the lid on the frypan

## Frypan recipes continued

and cook, covered for 1 minute. Remove lid and cook, uncovered, until all the water has evaporated. Remove from pan, repeat with remaining dumplings.

**Note:** The water should be simmering the entire time. If this does not happen increase the heat to setting 10.

5. Serve with dipping sauce.

**Tip:** Kecap manis, mirin and black vinegar are available at Asian grocery stores, or in the international section of supermarkets.

### Soy Sauce Chicken Wings

Serves 4

1½ kg chicken wings

½ cup honey

½ cup low salt soy sauce

2 teaspoons shao hsing cooking wine

2 cloves garlic, crushed

3 teaspoons grated fresh ginger

1. Cut wings at joints and discard tips.

2. Combine remaining ingredients in a jug.

3. Place wings in a single layer in electric frypan. Pour sauce over wings and turn to coat.

4. Turn electric frypan onto setting 6. Cook wings, turning occasionally. Cook for about 30 minutes or until browned and cooked through.

5. Serve with rice.

**Tip:** Shao hsing is a Chinese cooking wine and is available from Asian supermarkets. If unavailable then recipe can be substituted with sweet sherry.

### Chilli Crab

Serves 4

*Not suitable for model FP5500P*

6 raw blue swimmer crabs

3 green onions

2 tablespoons peanut oil

3 cloves garlic, chopped

1 large red chilli, chopped

3 teaspoons grated fresh ginger

½ cup tomato sauce

½ cup sweet chilli sauce – smooth paste variety

1 tablespoon oyster sauce

1 tablespoon fish sauce

½ cup chicken stock

1 tablespoon grated palm sugar

Steamed jasmine rice, to serve

1. Remove flap from the undersides of crabs then flip crab over. Place your thumb under the shell between the two back legs and slowly pull the shell away from the body. Discard. Remove the feather-like gills and front feelers and discard. Carefully rinse the crab if needed – do not put under running water. Using a sharp knife cut the body in half; then cut between the smaller legs to make 4 pieces. Crack the large nippers with crab crackers; this will help the heat get into the shell.

2. Slice green onions and separate the green ends from the white; set aside.

3. Heat oil in electric frypan on setting 8. Add whites of onions, garlic, chilli and ginger to pan and cook, stirring, until fragrant.

4. Reduce heat to setting 6 and add crabs. Combine remaining ingredients and pour over crabs. Stir crabs gently to coat then cook, covered, stirring occasionally for about 15 minutes or until the crabs have gone a deep orange colour and are just cooked through.

## Frypan recipes continued

**Tip:** A good way to see if the crabs are cooked is to check the joint on the large nipper. When these have changed colour your crabs should be cooked through.

5. Remove crabs from frypan onto a large serving platter and spoon over sauce from frypan. Sprinkle with sliced green onions.
6. Serve with steamed jasmine rice.

### Spanish Paella

**Serves 6-8**

2 small raw blue swimmer crabs  
(omit for *FP5500P*)

8 large green prawns

8 small black mussels

3½ cups fish/chicken stock

1 teaspoon saffron threads

180g chorizo sausage, sliced

200g chicken thighs, halved

1 tablespoon extra virgin olive oil

1 medium onion, chopped finely

1 clove garlic, crushed

¼ teaspoon smoked paprika

1 x 400g canned tomatoes

1½ cups Arborio or Spanish rice

300g whole pipis, purged

½ cup frozen peas

1 small roasted red capsicum, sliced

1. Remove flap from the undersides of crabs then flip crab over. Place your thumb under the shell between the two back legs and slowly pull the shell away from the body. Discard. Remove the feather-like gills and front feelers and discard. Carefully rinse the crab if needed – do not put under running water. Using a sharp knife cut the body in half; then cut between the smaller legs to make 4 pieces. Crack the large nippers with crab crackers; this will help the heat get into the shell.

2. Peel four of the prawns and devein. Leave the other four whole for presentation. Clean and de-beard mussels.

3. Place stock and saffron in a saucepan and heat gently to infuse. Cover and keep warm.

4. Heat the electric frypan on setting 8. Cook chorizo in pan until golden; drain on paper towelling.

5. In same pan cook the chicken thighs and whole prawns in chorizo oil until just cooked through; set aside.

6. Reduce heat to setting 6 and add extra virgin olive oil, if needed, in electric frypan and cook onions and garlic until the onions are translucent; add paprika and cook for a further 30 seconds.

7. Add tomatoes and cook on setting 6 for 2-3 minutes. Add rice and cook, stirring until well coated. Add stock and stir to combine. Reduce heat to setting 3 and cook, covered for 10 minutes.

8. After 10 minutes check rice, add a little water if the rice looks too dry. Cook, covered, for a further 5 minutes if the rice is still quite hard.

9. Arrange raw seafood, chicken, chorizo, whole prawns, peas, roasted capsicum, over rice and cook, covered for a further 5 minutes or until the seafood is cooked and the rice is tender. Turn heat off and keep covered for 5 minutes before serving.

## Frypan recipes continued

### Family Beef Casserole with Semi Dried Tomatoes

Serves 6-8

*Half quantity recommended for model FP5500P*

2 kg chuck steak, cut into 2cm cubes

½ cup flour

3 tablespoons olive oil

2 bunches of spring onion, stalk trimmed, peeled and left whole

2 cloves garlic, crushed

⅓ cup tomato paste

½ cup red wine

3 carrots, diced

3 celery stalks, sliced

1 cup beef stock

1 cup water

2 tablespoons chopped fresh thyme

2 bay leaves

1 cup semi dried tomatoes

Salt and freshly ground black pepper

1. Dust beef in flour, shaking off excess flour. Heat oil in frypan and cook beef in batches until brown. Set aside.
2. To the same pan, add onion and garlic, cook, stirring for 1-2 minutes, or until onion starts to colour. Stir through tomato paste and cook for 1 minute.
3. Add wine and allow alcohol to evaporate and liquid to reduce slightly. About 2 minutes.
4. Place beef, vegetables, stock, water, thyme and bay leaves in frypan. Cover and cook on setting 4 for 1 hour, stirring occasionally. After 1 hour add tomatoes and cook for a further 20-30 minutes or until beef is tender.
5. Season to taste and serve hot with mashed potatoes or rice.

### Pan Fried Chicken Breast with Salsa Verde

Serves 6

1-2 tablespoons olive oil

6 chicken breast fillets

#### Salsa Verde

1 cup fresh flat leaf parsley

½ cup dill

½ cup fresh mint leaves

2 cloves garlic

1 tablespoon small capers

1 tablespoon grated lemon rind

Sea salt and freshly ground black pepper

¾ cup extra virgin olive oil

1. Heat frypan on setting 7. Add oil and cook chicken, uncovered, until browned on both sides and cooked through. Remove from heat and serve with Salsa Verde.
2. To make the Salsa Verde, blend or process all ingredients until a chunky sauce texture is achieved.

**Tip:** Salsa Verde also goes very well with pan fried fish fillets.



## Frypan recipes continued

### **Pan Fried Fish with Garlic and Lemon** Serves 4

4 (800g) white fish fillets  
2 tablespoons olive oil  
2 cloves garlic, crushed  
2 tablespoons lemon juice  
2 eschalots, minced  
¼ cup shredded fresh basil leaves  
Sea salt and freshly ground black pepper  
Steamed new potatoes or mash, to serve  
Steamed broccolini, to serve

1. Place fish in a shallow baking dish. In a small bowl combine the garlic, lemon juice, eschalots, basil, salt and pepper and mix well.
2. Pour marinade over fish and allow to sit at room temperature for 20 minutes.
3. Heat frypan on setting 9. Add oil and cook fish for 3-5 minutes on both sides until just cooked through.

Note: Cooking time will vary depending on the thickness of each fillet.

4. Serve fish with potatoes and steamed broccolini.

### **Beef Stroganoff** Serves 4

2 tablespoons plain flour  
1 kg beef strips  
2 tablespoons olive oil  
2 small cloves garlic, crushed  
¼ cup tomato paste  
1 cup beef stock  
250g button mushrooms, sliced  
⅓ cup sour cream  
Salt and freshly ground black pepper

1. Dust beef in flour, shaking off excess flour. Heat oil in frypan on setting 6; cook beef in batches until browned.
2. Return all beef to pan and add remaining

ingredients, except sour cream. Cover and cook on setting 4 for about 45 minutes or until the beef is tender.

3. Stir through sour cream. Season with salt and pepper. Serve with buttered noodles.

### **Creamy Oyster Chicken** Serves 4

800g chicken tenders  
¼ cup flour  
1 tablespoon olive oil  
300ml cream  
¼ cup oyster sauce  
200g small button mushrooms, quartered  
Salt and freshly ground black pepper  
steamed broccoli, to serve  
steamed rice, to serve

1. Lightly coat chicken in flour. Heat oil in frypan on setting 8. Cook chicken, in batches, until golden on each side. Remove from pan. The chicken should not be completely cooked through at this stage.
2. Add cream and oyster sauce to frypan; stir to combine. Add mushrooms and cook for 1 minute. Return chicken to frypan and cook, stirring occasionally until the sauce has thickened and the chicken is cooked through.
3. Serve with steamed broccoli and rice.

# Frypan recipes continued

## Steamed Salmon Parcels

Serves 4

- 4 x 180g Atlantic salmon fillets
- 1 stalk lemon grass, white only, chopped finely
- 4 eschalots, sliced thinly
- ½ cup fresh coriander leaves
- 1 large red chilli, seeded, sliced
- 2 cloves garlic, crushed
- 2 teaspoons grated fresh ginger
- ½ cup coconut milk
- Salt and freshly ground black pepper
- 1 tablespoon peanut oil
- 4-6 baby bok choy, quartered
- Steamed jasmine rice, to serve

1. Preheat electric frypan on setting 8 with the lid on for 5 minutes.
2. Combine the lemon grass, eschalots, coriander, chilli, garlic, ginger, coconut milk and salt and pepper in a bowl and mix well.
3. Place each piece of salmon on four individual pieces of baking paper. Divide the coconut mixture evenly over the tops of the salmon. Fold each piece of foil up to make four sealed parcels.
4. Place parcels in frypan and cook, covered, on setting 6 for about 12-15 minutes or until cooked as desired. Remove from heat.
5. Quickly increase heat in electric frypan and heat oil; toss bok choy for 1-2 minutes until wilted; season with salt and pepper.
6. Serve salmon with bok choy and steamed jasmine rice.

## Dhal

Serves 4-6

- 1 tablespoon vegetable oil
- 1 medium onion, finely chopped
- 1 clove garlic, crushed
- 3 teaspoons ground cumin
- ½ teaspoon cumin seeds
- 1 teaspoon black mustard seeds
- 2 tablespoons tomato paste
- 2 cups red lentils, rinsed and drained
- 2 cups vegetable stock
- 1 litre water
- 400g can chopped tomatoes
- 3 baby eggplants, chopped coarsely
- 4 hard boiled eggs, optional
- Salt and freshly ground black pepper

1. Heat oil in frypan on setting 4. Add onion and garlic and cook, stirring, for 2-3 minutes or until onion is soft.
2. Add dried spices and cook a further 1 minute, or until spices are fragrant. Stir through tomato paste and cook for 2 minutes.
3. Increase heat to setting 9; add lentils, stock and water and bring mixture to the boil. Reduce heat to setting 3 and cook, uncovered, stirring occasionally, until the mixture thickens slightly.
4. Add the tomatoes and eggplant and cook, covered, for 10 minutes. Remove lid and cook for a further 10 minutes or until dhal has thickened and the eggplant is soft.
5. Add whole peeled eggs and stir gently until heated through.
6. Season to taste.

## Frypan recipes continued

### **Penne Boscaiola**

6 rashers bacon  
200g sliced button mushrooms  
⅔ cup white wine  
300ml cream  
Salt and freshly ground black pepper  
500g penne  
shaved parmesan, to serve

1. Have a large pot of boiling water ready.
2. Remove rind from bacon and slice into 5mm pieces.
3. Heat frypan on setting 8. Cook bacon until golden. Add mushrooms and stir through.
4. Add wine and cook, stirring, until the wine has reduced by half. Add cream and cook, stirring occasionally, until the sauce has thickened slightly.
5. Cook pasta until just tender, drain and add to sauce and stir through. Season with salt and pepper. Serve immediately with shaved parmesan.

**Serves 4**

### **Lamb Tagine**

*Not suitable for model FP5500P*

2 tablespoons olive oil  
8 lamb shanks, fat trimmed  
1 large onion, sliced thinly  
2 cloves garlic, crushed  
1½ tablespoons Moroccan dried spice mix  
1 tablespoon tomato paste  
1 x 400g can chopped peeled tomatoes  
1 cup chicken stock  
1 cinnamon stick  
3 cardamom pods, cracked  
Salt and freshly ground black pepper  
1 x 400g tin chickpeas, drained and rinsed  
1 large sweet potato, peeled and chopped into 2 cm dice  
1 cup fresh coriander, roughly chopped  
Cous cous, to serve

1. Heat oil in frypan on setting 8. Cook lamb shanks in batches for 3-5 minutes or until evenly brown all over; remove from heat.
2. Reduce heat to setting 6, and add onion and garlic to frypan and cook for 5 minutes, or until onion has softened and coloured. Add spice mix and cook until fragrant. Stir through tomato paste.
3. Return the lamb shanks to the frypan with tomatoes, stock, cinnamon, and cardamom. Cover and cook, on setting 3, turning and stirring occasionally for 2 hours. After 2 hours add chickpeas, sweet potato and cook, covered until the sweet potato is tender.
4. Season to taste with salt and pepper. Stir through chopped coriander, serve with cous cous.

**Serves 4-6**

## Frypan recipes continued

### **Matt's Meatballs**

*Not suitable for model FP5500P*

- 1.2kg lean beef mince
- 2/3 cup packaged breadcrumbs
- 3 eggs
- 2 tablespoons Worcestershire sauce
- 2 teaspoons dried sweet basil
- 1 teaspoon dried oregano
- 2 cloves garlic, crushed
- Salt and freshly ground black pepper
- 2 tablespoons olive oil

#### **Sauce**

- 1 onion, sliced
  - 2 cloves garlic, crushed
  - 2 tablespoons tomato paste
  - 1 green capsicum, sliced
  - 1 red capsicum, sliced
  - 1 litre ketchup
1. Combine meatball ingredients; roll into balls slightly smaller than golf balls.
  2. Heat half of the oil in frypan on setting 6. Cook meatballs, in batches, until browned all over. Remove from pan.
  3. Heat remaining oil in frypan on setting 5; cook onions and garlic, stirring, until the onions are translucent. Add tomato paste and cook for about 1-2 minutes or until fragrant. Add capsicums; cook, stirring occasionally, until tender. Add sauce and cook for 10 minutes. Reduce heat to setting 4; add meatballs and cook, covered, for a further 10 minutes or until the meatballs are cooked through.
  4. Serve in long crusty bread rolls as a sub sandwich or with pasta.

### **Serves 6-8**

### **Lamb Rack with Garlic and Parmesan Crust**

### **Serves 4**

- 2 x 400g lamb rack roast, French trimmed
- 4 slices of day old bread, crust removed
- 2 cloves garlic, chopped
- 2 tablespoons grated fresh parmesan
- 1 tablespoon chopped fresh rosemary
- 2 tablespoons seeded mustard
- Olive oil spray
- Salt and freshly ground black pepper
- Mashed potatoes, to serve

1. Preheat frypan on setting 7.
2. Place lamb racks on a chopping board, having the bones interlocked in the middle.
3. Combine bread, garlic, parmesan and rosemary in a food processor. Process until mixture resembles fine breadcrumbs.
4. Spread mustard evenly over the outside of the cutlets flesh.
5. Press the bread mixture over the mustard and spray well with olive oil spray.
6. Place lamb racks in frypan, reduce heat to setting 3 and cook, covered, for about 35 minutes or until cooked as desired. Remove from frypan and cover with foil. Allow to rest 5-10 minutes.
7. Cut lamb into individual cutlets and serve with mashed potatoes.

**Tip:** Recipe can be doubled to serve 8.

## Frypan recipes continued

### Roast Chicken with Stuffing

Serves 4

1.2kg whole fresh chicken  
Salt and freshly ground black pepper

#### Stuffing

1 onion, chopped finely  
2 teaspoons olive oil  
3 cups fresh bread crumbs  
30g butter, softened  
1 teaspoon grated lemon rind  
2 tablespoons chopped fresh parsley  
2 teaspoons chopped fresh thyme

1. Wash and clean chicken thoroughly. Pat dry with paper towelling.
2. To make stuffing, cook onion in oil until softened. Add to remaining stuffing ingredients and mix well.
3. Place the stuffing inside the cavity of the chicken. Tuck the wings back and tie the base of the chicken with cooking string so that the legs are crossed and securely positioned.
4. Preheat frypan on setting 7. Brush chicken with a little oil and salt and pepper.
5. Brown chicken on all sides; reduce heat to setting 5 and cook, covered, with the vent open, for about 1½ hours or until cooked through.

**Tip:** If cooking roast vegetables, place in frypan ¾ to 1 hour before the end of cooking.

### Roast Lamb

Serves 4-6

1 leg lamb  
4-6 garlic cloves, sliced  
3-4 sprigs fresh rosemary, snipped into small pieces  
2 tablespoons olive oil  
Salt and freshly ground black pepper  
6 small picking onions  
400g pumpkin, cut into chunks  
½ bunch baby carrots, trimmed  
2 potatoes, peeled, chopped  
1 sweet potato, peeled and thickly sliced

1. Using a small sharp knife, pierce the lamb all over, making indentations about 2cm deep. Push a piece of garlic into each slit and a small piece of rosemary. The rosemary should be poking out slightly.
2. Heat frypan to setting 10. Add oil and brown lamb all over. Season with salt and pepper; add onions to pan. Reduce heat to setting 6. Cook lamb, covered, for about 1 hour and 15 minutes.
3. Add vegetables to pan and cook for a further 25 minutes. Remove lamb and allow to rest, covered, until the vegetables are cooked as desired.

## Frypan recipes continued

### Mustard Seed Potatoes

Serves 8

- 1.5kg baby new potatoes
- 2 tablespoons extra virgin olive oil
- 2 tablespoons black mustard seeds
- 1-2 teaspoons sea salt flakes

1. Place potatoes into frypan and pour enough water in to cover. Cook potatoes, covered, on setting 10 until tender. Drain well for 10 minutes.

**Note:** If using model FP5500P, we recommend boiling potatoes in a separate pan.

2. Heat frypan on setting 8, add oil, potatoes, mustard seeds and salt; stir to coat. Place lid on potatoes and cook, stirring occasionally, until the potatoes are golden.

**Tip:** Keep the lid on during cooking as the mustard seeds pop!

### Individual Sticky Date Puddings

Serves 8

- 200g coarsely chopped dried dates
- 1 teaspoon bicarbonate soda
- 1¼ cups boiling water
- 60ml olive oil
- 1 cup firmly packed brown sugar
- 1 cup self raising flour
- ¼ teaspoon mixed spice
- 2 eggs

#### Butterscotch sauce

- 160g butter
- ⅔ cup firmly packed brown sugar
- 1 cup (250ml) thickened cream

1. Preheat frypan on setting 4 with the lid on. Grease 8 individual 1-cup capacity metal moulds.
2. Place dates, soda and boiling water into a blender or food processor. Place lid on and allow the mixture to stand for 5 minutes.
3. Add oil and sugar and pulse 3 times.
4. Add remaining ingredients and pulse mixture until just combined. Scrape down sides of bowl if necessary. Do not over process.
5. Pour mixture into prepared moulds. Place moulds in frypan and carefully pour enough boiling water to come half way up the sides of the moulds. Cook for about 25 minutes or until cooked when tested with a wooden skewer. Carefully remove from frypan; stand for 5 minutes before turning out onto a wire rack.
6. Serve pudding with butterscotch sauce. To make sauce, heat all ingredients in a small saucepan over a low heat until combined.

**Tip:** Puddings can be made in advance and then rewarmed in a microwave.

## Frypan recipes continued

### **Caramelised Bananas with Hot Chocolate Sauce and Whipped Cream** Serves 4

4 large bananas  
¼ cup firmly packed brown sugar  
1 teaspoon cinnamon  
Whipped cream, to serve

Hot chocolate sauce  
100g dark chocolate, chopped  
30g white marshmallows, chopped  
150ml thickened cream

1. Preheat frypan on setting 4.
2. Cut bananas in half lengthways, leaving the skin on. Sprinkle the combined sugar and cinnamon over the cut bananas. Press gently into the banana.
3. Place bananas, cut side down and cook, uncovered, for about 6 minutes or until the sugar has caramelised and the banana has softened. Serve bananas with hot chocolate sauce and whipped cream.
4. To make the hot chocolate sauce, combine all ingredients in a small saucepan and cook, stirring, over a low heat, until melted.

### **Spiced Rhubarb and Berry Compote** Serves 4-6

2 bunches of rhubarb, cut into 2cm pieces  
500g frozen mixed berries  
¾ cup sugar  
1 cinnamon stick  
3 whole cloves  
1 teaspoon grated orange rind

1. Combine all ingredients into the frypan. Cook, stirring gently, on setting 8 until the sugar dissolves. Cover and cook on setting 5 for about 15 minutes or until the rhubarb is tender.
2. Serve hot with ice cream, custard or with your favourite pudding.

### **Crème Caramel** Serves 6

1 cup caster sugar  
½ cup water  
⅓ cup caster sugar, extra  
3 eggs  
2 egg yolks  
250ml cream  
250ml milk  
1 vanilla bean, seeds scraped

1. Combine sugar and water in a small saucepan. Stir over a low heat until the sugar has dissolved. Increase heat; boil without stirring, until the toffee turns a golden colour.
2. Remove from heat, once the bubbles have subsided, pour into 6 individual 1-cup capacity metal moulds. Allow to cool.
3. Beat eggs and extra sugar until light and creamy.
4. Heat milk, cream, vanilla bean and seeds until almost boiling. Whisk hot milk into egg mixture. Pour mixture through a strainer.
5. Pour mixture into moulds. Place moulds into frypan. Pour enough boiling hot water to come halfway up the sides of the moulds.
6. Cook, covered, on setting 6 for about 15 minutes or until the custard has set.

**Note:** Be careful when removing lid to check custard that no water from the lid goes into the moulds.

# Skillet Recipes

The following recipes are also suitable for your Classic Skillet. Please note that it will be necessary to cook in batches.

Corn Fritters	Page 19
Gyoza (Japanese dumplings)	Page 19
Pan Fried Chicken Breast with Salsa Verde	Page 22
Pan Fried Fish with Garlic and Lemon	Page 23
Caramelised Bananas with Hot Chocolate sauce	Page 29

---

## Buttermilk Pancakes

**Makes 8**

- 1 cup self raising flour
- 2 tablespoons sugar
- ½ teaspoon bicarbonate of soda
- 1 egg, lightly beaten
- 2 tablespoons vegetable oil
- 1 cup buttermilk
- 60g butter

1. Sift dry ingredients into a large bowl. Make a well in the centre.
2. Whisk the combined wet ingredients into the dry ingredients until smooth.
3. Heat skillet on setting 6. Melt some of the butter and spoon ¼ cupfuls of mixture at a time into the skillet. Turn the pancakes once the bottom is golden and the tops starts to bubble. Cook until the underside is golden.
4. Serve with extra butter and maple syrup.

## Pikelets

**Makes approx. 12**

- 1 egg
- ¼ cup sugar
- 1 cup self raising flour
- ¾ cup milk
- pinch salt
- butter for frying

1. Beat egg and sugar with an electric mixer until light and creamy.
2. Add flour, milk and salt and beat until smooth.
3. Heat skillet on setting 8. Melt a little butter in skillet and wipe away any excess with paper towelling.
4. Spoon heaped spoonfuls of batter in skillet and cook on both sides until golden.
5. Serve with butter, jam, cream or chocolate hazelnut spread.

**For savoury pikelets:** Reduce sugar to 2 tablespoons and stir through chopped fresh herbs of choice. Top with slices of prosciutto, goats cheese and rocket, or cream cheese, smoked salmon and capers.



## Skillet Recipes continued

### Scrambled Eggs

Serves 2

4 large eggs  
2/3 cup thickened cream  
Salt and freshly ground black pepper  
20g butter  
Toast, to serve

1. In a medium bowl, whisk the eggs, cream, salt and pepper until well combined. Heat butter in skillet over a medium heat until it bubbles.
2. Pour in the egg mixture and cook, stirring with a wooden spoon, until the eggs are just starting to firm but are still quite moist.
3. Serve immediately with hot, buttered toast.

### Sweet Crepes

Makes approx. 16 crepes

3 eggs  
60g butter, melted  
1 3/4 cups milk  
250g plain flour  
2 tablespoons caster sugar

1. Place crepe ingredients into a blender jug and blend on low for about 20 seconds or until combined. Strain into a jug and stand for 30 minutes.
2. Heat skillet on setting 7. Pour about 1/4 cup of batter into the greased pan. Tilt the pan to spread the mixture evenly. Cook over a low heat on both sides until golden. Repeat with remaining mixture.
3. Serve crepes with lemon juice and sugar or hazelnut spread.

### Omelette with Porcini Mushrooms

Serves 2

40g dried porcini mushrooms  
4 eggs  
Salt and freshly ground black pepper  
butter  
1/4 cup grated parmesan cheese

1. Soak mushrooms in hot water for 10 minutes; drain and roughly chop.
2. Whisk eggs, mushrooms, salt and pepper in a medium bowl until combined.
3. Melt butter in skillet on setting 8; once bubbles have subsided pour in egg mixture. Once the egg mixture has begun to cook underneath use a wooden spoon to bring in the edges of the egg mixture into the centre of the skillet (this creates height in your omelette). Do this 2-3 times then allow the omelette to brown slightly underneath and almost set on the top.
4. Sprinkle the cheese over half of the omelette, then using a spatula, carefully fold the omelette in half. Cook for a further 30 seconds.
5. Carefully tip omelette onto a serving plate.

# Notes

# 12 Month Replacement Guarantee

In the unlikely event that this appliance develops any malfunction within 12 months of purchase (3 months commercial use) due to faulty materials or manufacture, we will replace it for you free of charge.

Should you experience any difficulties with your appliance, please phone our customer service line for advice on 1300 881 861 in Australia, or 0800 786 232 in New Zealand. Alternatively, you can send a written claim to Sunbeam at the address listed below. On receipt of your claim, Sunbeam will seek to resolve your difficulties or, if the appliance is defective, advise you on how to obtain a replacement or refund.

Your Sunbeam 12 Month Replacement Guarantee naturally does not cover misuse or negligent handling and normal wear and tear.

Similarly your 12 Month Replacement Guarantee does not cover freight or any other costs incurred in making a claim. Please retain your receipt as proof of purchase.

The benefits given to you by this guarantee are in addition to your other rights and remedies under any laws which relate to the appliance.

Our goods come with guarantees that cannot be excluded under the Australian Consumer Law and under the New Zealand Consumer Guarantees Act.

In Australia you are entitled to a replacement or refund for a major failure and for compensation for any other reasonably foreseeable loss or damage. You are also entitled to have the goods repaired or replaced if the goods fail to be of acceptable quality and the failure does not amount to a major failure.

Should your appliance require repair or service after the guarantee period, contact your nearest Sunbeam service centre.

For a complete list of Sunbeam's authorised service centres visit our website or call:

## **Australia**

[www.sunbeam.com.au](http://www.sunbeam.com.au)

**1300 881 861**

Units 5 & 6, 13 Lord Street  
Botany NSW 2019 Australia

## **New Zealand**

[www.sunbeam.co.nz](http://www.sunbeam.co.nz)

**0800 786 232**

26 Vestey Drive, Mt Wellington  
Auckland, New Zealand

## Need help with your appliance?

Contact our customer service team or visit our website for information and tips on getting the most from your appliance.

### In Australia

Visit [www.sunbeam.com.au](http://www.sunbeam.com.au)

Or call 1300 881 861

### In New Zealand

Visit [www.sunbeam.co.nz](http://www.sunbeam.co.nz)

Or call 0800 786 232

 is a registered trademark.

'Classic' is a registered trademark of Sunbeam Corporation.

'Sunbeam Family Banquet' is a trademark of Sunbeam Corporation.

'Teflon' and 'Platinum Pro' are trademarks of DuPont.

Made in China.

Due to minor changes in design or otherwise, the product may differ from the one shown in this leaflet.

© Copyright. Sunbeam Corporation Limited 2005.

ABN 45 000 006 771

Units 5 & 6, 13 Lord Street  
Botany NSW 2019 Australia

Unit 3, Building D  
26 Vestey Drive  
Mt Wellington Auckland  
New Zealand

Sunbeam Corporation is a division of GUD Holdings Ltd.